

# LCD REAR PROJECTION TELEVISION

## Operating Guide for 50V525E, 60V525E

IMPORTANT SAFETY INSTRUCTIONS .....	2-3
FIRST TIME USE .....	4-19
THE REMOTE CONTROL .....	20-33
ON-SCREEN DISPLAY .....	34-61
LAMP REPLACEMENT .....	62-65
CARE OF YOUR HITACHI TV & REMOTE CONTROL .....	66
RECEPTION PROBLEMS .....	67
USEFUL INFORMATION / INDEX .....	68-72

As an ENERGY STAR® Partner, Hitachi, Ltd. has determined that this product meets the ENERGY STAR® guidelines for energy efficiency.





# IMPORTANT SAFETY INSTRUCTIONS





## SAFETY POINTS YOU SHOULD KNOW ABOUT YOUR HITACHI LCD REAR PROJECTION TELEVISION

Our reputation has been built on the quality, performance, and ease of service of HITACHI televisions.

Safety is also foremost in our minds in the design of these units. To help you operate these products properly, this section illustrates safety tips which will be of benefit to you. Please read it carefully and apply the knowledge you obtain from it to the proper operation of your HITACHI television.

Please fill out your warranty card and mail it to HITACHI. This will enable HITACHI to notify you promptly in the improbable event that a safety problem should be discovered in your product model.

Follow all warnings and instructions marked on this television.

 <div style="text-align: center;"> <p><b>CAUTION</b></p> <p><b>RISK OF ELECTRIC SHOCK</b></p> <p><b>DO NOT OPEN</b></p> </div> 	 <p>The lightning flash with arrowhead symbol, within an equilateral triangle, is intended to alert the user to the presence of uninsulated "dangerous voltage" within the product's enclosure that may be of a sufficient magnitude to constitute a risk of electric shock to persons.</p>
<p>CAUTION: TO REDUCE THE RISK OF ELECTRIC SHOCK, DO NOT REMOVE COVER (OR BACK). NO USER SERVICEABLE PARTS INSIDE. REFER SERVICING TO QUALIFIED SERVICE PERSONNEL.</p>	 <p>The exclamation point within an equilateral triangle, is intended to alert the user to the presence of important operating and maintenance (servicing) instructions in the literature accompanying the appliance.</p>

**WARNING:**

- TO REDUCE THE RISK OF FIRE OR ELECTRIC SHOCK, DO NOT EXPOSE THIS APPARATUS TO RAIN OR MOISTURE.
- THE TELEVISION SHOULD NOT BE EXPOSED TO DRIPPING OR SPLASHING AND OBJECTS FILLED WITH LIQUIDS, SUCH AS VASES, SHOULD NOT BE PLACED ON THE TELEVISION.

**NOTE:**

- There are no user serviceable parts inside the television.
- Model and serial numbers are indicated on back side of the television.

**CAUTION:** Adjust only those controls that are covered in the instructions, as improper changes or modifications not expressly approved by HITACHI could void the user's authority to operate the television.



**MODIFICATIONS:** The FCC requires the user to be notified that any changes or modifications made to this device that are not expressly approved by Hitachi America, Ltd. Home Electronics Division may void the user's authority to operate the equipment.

**POWER SOURCE**

**THIS TELEVISION IS DESIGNED TO OPERATE ON 120 VOLTS 60Hz, AC CURRENT. INSERT THE POWER CORD INTO A 120 VOLT 60Hz OUTLET.**

**TO PREVENT ELECTRIC SHOCK, DO NOT USE THE TELEVISION'S (POLARIZED) PLUG WITH AN EXTENSION CORD, RECEPTACLE, OR OTHER OUTLET UNLESS THE BLADES AND GROUND TERMINAL CAN BE FULLY INSERTED TO PREVENT BLADE EXPOSURE.**

**NEVER CONNECT THE TELEVISION TO 50Hz, DIRECT CURRENT, OR ANYTHING OTHER THAN THE SPECIFIED VOLTAGE.**

**NOTE:** This television receiver will display television closed captioning, ( or ) , in accordance with paragraph 15.119 of the FCC rules.

 **CAUTION:** Never remove the back cover of the television as this can expose you to very high voltages and other hazards. If the television does not operate properly, unplug the television and call your authorized dealer or service center.



# IMPORTANT SAFETY INSTRUCTIONS

## Read before operating equipment

Follow all warnings and instructions marked on this television.

1. Read these instructions.
2. Keep these instructions.
3. Heed all warnings.
4. Follow all instructions.
5. Do not use this apparatus near water.
6. Clean only with a dry cloth.
7. Do not block any ventilation openings. Install in accordance with the manufacturer's instructions.
8. Do not install near any heat sources such as radiators, heat registers, stoves, or other apparatus (including amplifiers) that produce heat.
9. Do not defeat the safety purpose of the polarized or grounding-type plug. A polarized plug has two blades with one wider than the other. A grounding type plug has two blades and a third grounding prong. The wide blade or the third prong are provided for your safety. If the provided plug does not fit into your outlet, consult an electrician for replacement of the obsolete outlet.
10. Protect the power cord from being walked on or pinched particularly at plugs, convenience receptacles, and the point where they exit from the apparatus.
11. Only use the attachments/accessories specified by the manufacturer.



Use only with the cart, stand, tripod, bracket, or table specified by the manufacturer, or sold with the apparatus. When a cart is used, use caution when moving the cart/apparatus combination to avoid injury from tip-over.

13. Unplug this apparatus during lightning storms or when unused for long periods of time.
14. Refer all servicing to qualified service personnel. Servicing is required when the apparatus has been damaged in any way, such as power-supply cord or plug is damaged, liquid has been spilled or objects have fallen into apparatus, the apparatus has been exposed to rain or moisture, does not operate normally, or has been dropped.

15. Televisions are designed to comply with the recommended safety standards for tilt and stability. Do not apply excessive pulling force to the front, or top, of the cabinet which could cause the product to overturn resulting in product damage and/or personal injury.
16. Follow instructions for wall, shelf or ceiling mounting as recommended by the manufacturer.
17. An outdoor antenna should not be located in the vicinity of overhead power lines or other electrical circuits.
18. If an outside antenna is connected to the receiver be sure the antenna system is grounded so as to provide some protection against voltage surges and built up static charges. Section 810 of the National Electric Code, ANSI/NFPA No. 70-1984, provides information with respect to proper grounding for the mast and supporting structure, grounding of the lead-in wire to an antenna discharge unit, size of grounding connectors, location of antenna-discharge unit, connection to grounding electrodes and requirements for the grounding electrode.

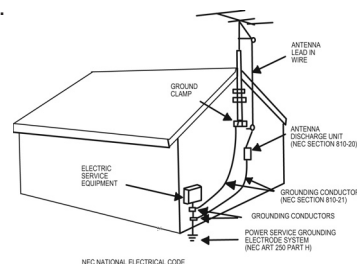

Note to the CATV system installer: This reminder is provided to call the CATV system installer's attention to Article 820-40 of the NEC that provides guidelines for proper grounding and, in particular, specifies that the cable ground shall be connected to the grounding system of the building, as close to the point of cable entry as practical.

**Do not place any objects on the top of the television which may fall or cause a child to climb to retrieve the objects.**

- **This product contains lead and a lamp that contains mercury. Dispose of this product and its lamp in accordance with applicable environmental laws. For lamp recycling and disposal information, go to [www.lamprecycle.org](http://www.lamprecycle.org). For product recycling and disposal information, contact your local government agency or the Electronic Industries Alliance at [www.eiae.org](http://www.eiae.org) (in the US) or the Electronic Product Stewardship Canada at [www.epsc.ca](http://www.epsc.ca) (in Canada). For more information, call "1-800-HITACHI."**

### PUBLIC VIEWING OF COPYRIGHTED MATERIAL

Public viewing of programs broadcast by TV stations and cable companies, as well as programs from other sources, may require prior authorization from the broadcaster or owner of the video program material.

- This product incorporates copyright protection technology that is protected by U.S. patents and other intellectual property rights. Use of this copyright protection technology must be authorized by Macrovision Corporation, and is intended for home and other limited consumer uses only unless otherwise authorized by Macrovision. Reverse engineering or disassembly is prohibited.



Check to make sure you have the following accessories before disposing of the packing material.

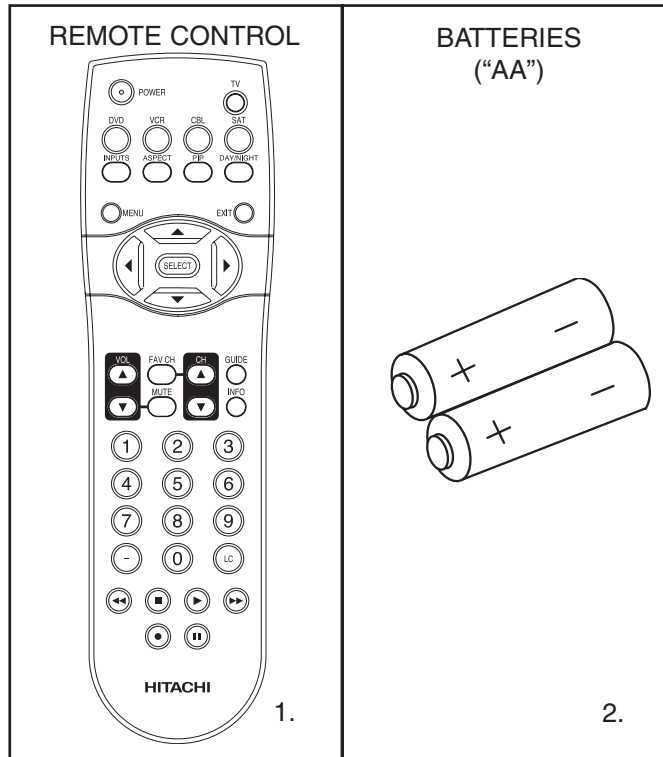

1. Remote Control Unit CLU-4341UG2 (Part No. HL02071) or Remote Control Unit CLU-4351UG2 (Part No. HL02072).
2. Two "AA" size, 1.5V batteries (For Remote Control Unit).

## REMOTE CONTROL BATTERY INSTALLATION AND REPLACEMENT

1. Open the battery cover of the remote control by pushing the notched part of the cover with your fingers and pulling the cover off.
2. Insert two new "AA" size batteries for the remote control. When replacing old batteries, push them towards the springs and lift them out.
3. Match the batteries to the (+) and (-) marks in the battery compartment.
4. Replace the cover.

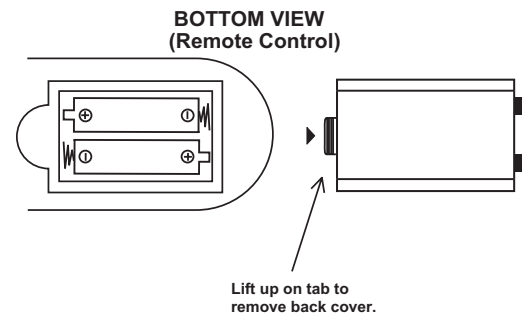

**CAUTION:** Danger of explosion if battery is incorrectly replaced. Replace with the same or equivalent type.



# HOW TO SET UP YOUR NEW HITACHI LCD REAR PTV

FIRST TIME USE

## ANTENNA

Unless your LCD Rear PTV is connected to a cable TV system or to a centralized antenna system, a good outdoor TV antenna is recommended for best performance. However, if you are located in an exceptionally good signal area that is free from interference and multiple image ghosts, an indoor antenna may be sufficient.

## LOCATION

Select an area where sunlight or bright indoor illumination will not fall directly on the picture screen. Also, be sure that the location selected allows a free flow of air to and from the perforated back cover of the set.

To avoid cabinet warping, cabinet color changes, and increased chance of set failure, do not place the TV where temperatures can become excessively hot, for example, in direct sunlight or near a heating appliance, etc.

When installing your LCD Rear PTV against a wall, keep it at least 10 cm (4 inches) from the wall.

## VIEWING

The major benefit of the HITACHI LCD Rear PTV is its large viewing screen. To see this large screen at its best, test various locations in the room to find the optimum spot for viewing.

The best picture is seen by sitting directly in front of the TV and about 10 to 18 feet from the screen. Picture brightness decreases as the viewer moves to the left and right of the receiver.

During daylight hours, reflections from outside light may appear on the screen. If so, drapes or screens can be used to reduce the reflection or the TV can be located in a different section of the room.

If the TV's audio output will be connected to a Hi-Fi system's external speakers, the best audio performance will be obtained by placing the speakers equidistant from each side of the receiver cabinet and as close as possible to the height of the picture screen center. For best stereo separation, place the external speakers at least four feet from the side of the TV, place the surround speakers to the side or behind the viewing area. Differences in room sizes and acoustical environments will require some experimentation with speaker placement for best performance.

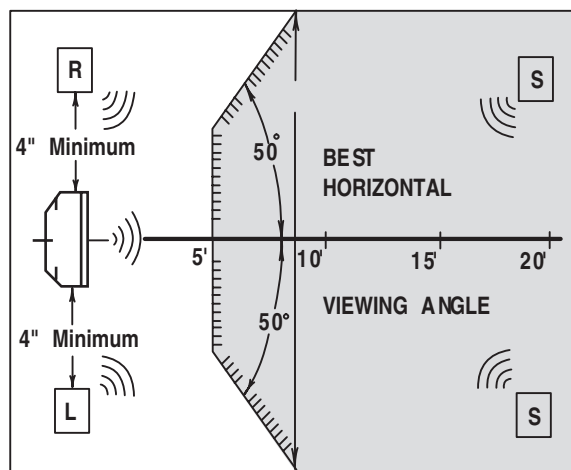
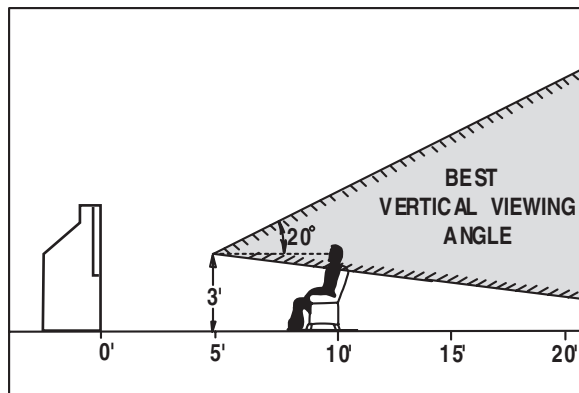

### IMPORTANT NOTES:

1. Since LCD Rear PTV incorporates a high pressure lamp to display an image, it may take about one minute for the picture to become stable, after the power has been turned on. After extended use, the picture may darken, the color may look unusual, or the lamp "goes out," (burns out). You may hear a "pop" sound when the lamp "goes out." These are common characteristics of the lamp, and should not be considered defective.
2. LCD Rear PTV incorporates an advanced cooling fan system to prevent from overheating. If you hear the cooling fan, it should not be considered defective.
3. If you hear a "cracking" sound from the TV cabinet, it is due to the TV's cabinet expanding and contracting due to room temperature changes. It has no effect on the TV's functions.
4. The LCD Rear PTV cabinet is constructed with all plastic. Make sure to place it on a flat surface. An uneven surface might warp the cabinet and reduce the picture quality.



# HOOK-UP CABLES AND CONNECTORS

FIRST TIME USE

Most video/audio connections between components can be made with shielded video and audio cables that have phono connectors. For best performance, video cables should use 75-Ohm coaxial shielded wire. Cables can be purchased from most stores that sell audio/video products. Below are illustrations and names of common connectors. Before purchasing any cables, be sure of the output and input connector types required by the various components and the length of each cable.

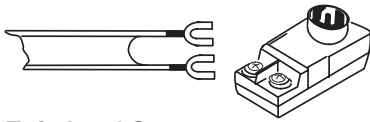

### 300-Ohm Twin Lead Connector

This outdoor antenna cable must be connected to an antenna adapter (300-Ohm to 75-Ohm).



### "F" Type 75-Ohm Coaxial Antenna Connector

For connecting RF signals (antenna or cable TV) to the antenna jack on the television.



### Phono Connector

Used on all standard video and audio cables which connect to inputs and outputs located on the television's rear jack panel and front control panel.



### S-Video (Super Video) Connector

This connector is used on camcorders, VCRs and laser-disc players with an S-Video feature in place of the standard video cable to produce a high quality picture.

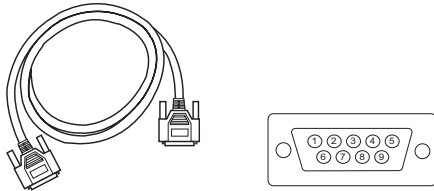

### D-SUB MINI 9-Pin Cable

This cable is used to connect to the RS232C input located on the rear panel so you can control some of your TV functions from an external home control system.

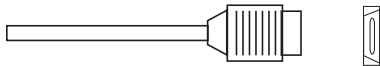

### HDMI Cable

This cable is used to connect your external devices such as Set-Top-Boxes or DVD players equipped with an HDMI output connection to the TV's HDMI input.

## ANTENNA CONNECTIONS TO REAR JACK PANEL

### VHF (75-Ohm) antenna/CATV (Cable TV)

When using a 75-Ohm coaxial cable system, connect CATV coaxial cable to the ANT A (75-Ohm) terminal. If you have an antenna, connect the coaxial cable to the ANT B terminal.

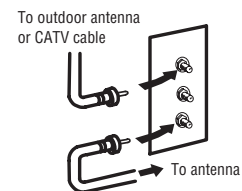

### VHF (300-Ohm) antenna/UHF antenna

When using a 300-Ohm twin lead from an outdoor antenna, connect the VHF or UHF antenna leads to screws of the VHF or UHF adapter. Plug the adapter into the antenna terminal on the TV.

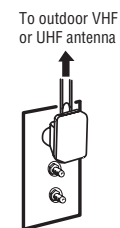

### When both VHF and UHF antennas are connected

Attach an optional antenna cable mixer to the TV antenna terminal, and connect the cables to the antenna mixer. Consult your dealer or service store for the antenna mixer.

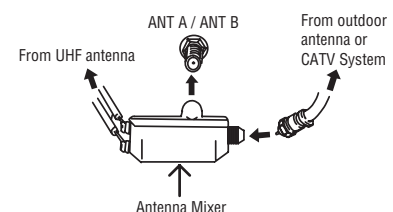

# FRONT PANEL CONTROLS

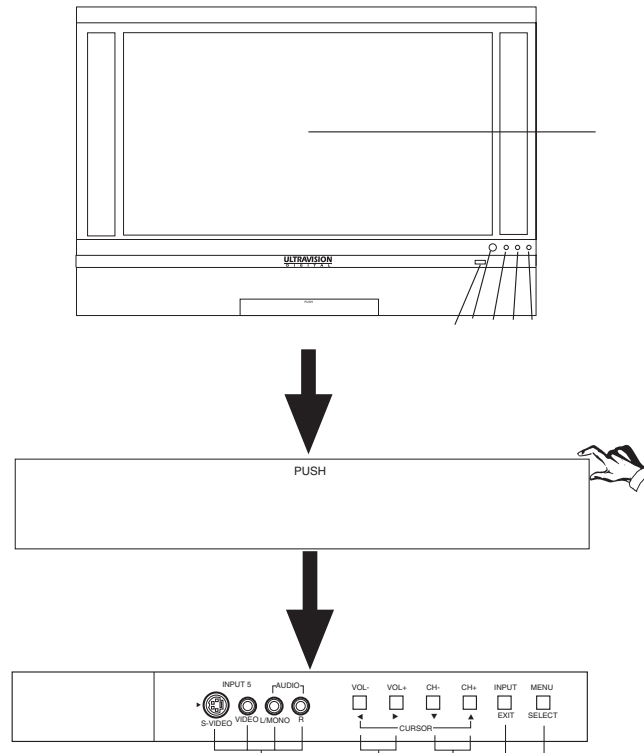

## MENU/SELECT button

This button allows you to enter the MENU, making it possible to set TV features to your preference without using the remote. This button also serves as the SELECT button when in MENU mode.

## INPUT/EXIT button

Press this button to display the input menu, Ant A/B, INPUT:1,2,3,4 or 5. This button also serves as the EXIT button when in MENU mode.

## CHANNEL selector

Press these buttons until the desired channel appears in the top right corner of the TV screen. These buttons also serve as the cursor down (▼) and up (▲) buttons when in MENU mode.

## VOLUME level

Press these buttons for your desired sound level. The volume level will be displayed on the TV screen. These buttons also serve as the cursor left (◀) and right (▶) buttons when in MENU mode. When the TV power is turned OFF at a volume level 31 or greater, the volume level will default to 30 when the TV is turned ON. However, if it is set to a level 30 or less, the volume level will be at the level it was set when the TV is turned ON.

## FRONT INPUT JACKS (INPUT 5)

Use these audio/video jacks for a quick hook-up from a camcorder or VCR to instantly view your favorite show or new recording. Press the INPUT/EXIT button on the front control panel until VIDEO: 5 appears in the top right corner of the TV screen. If you have mono sound, insert the audio cable into the left audio jack.

## IR RECEIVER sensor

The screen area acts as the IR receiver (remote sensor). When using the remote control, point it towards the screen for best response.

## POWER button

Press this button to turn the TV on or off.



### POWER light

This light is on during normal operation.

Light Blinking Slowly (2 seconds): television lamp is cooling down. It takes 12-15 seconds to warm up and about 2 minutes to cool down.

### NOTES:

INDICATOR	INDICATION	MEANING		ACTION
LAMP LED	LIGHT ON	NO LAMP LIGHT or BROKEN LAMP		Need to replace if LAMP still does not light by "Power On" again. Check assembly condition of LAMP UNIT
	BLINKING	WRONG LAMP UNIT ASSEMBLY / LAMP DOOR OPEN		
TEMP LED	LIGHT ON	Too hot inside the OPTIC unit		Call for Service
	BLINKING	COOLING FAN STOPPED		
POWER	LIGHT ON	NORMAL OPERATION		
	FAST BLINKING	COOL DOWN	1. ~5 secs.	Lamp is still on. Power ON is available.
			2. 5~15 secs.	Lamp is off. Power ON is not available.
SLOW BLINKING	COOL DOWN	3. 15~20 secs.	Lamp is off. Power ON is available.	

2. If the LAMP, TEMP, and POWER LED are blinking in the order below, the television is warming up.

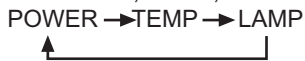

3. Your Hitachi LCD Rear Projection Television may appear to be OFF when it is set to input 1 ~ input 5 and the video signal is not received from the input jacks. Please make sure the Blue Power light indicator is not lit (OFF) when you are not watching for long lasting performance.

4. Your Hitachi LCD Rear Projection Television has an internal lamp that lights up the TV screen. Make sure to turn off the Power when you do not watch the LCD Rear Projection Television for longer lamp life.

### TEMP indicator

This light is off during normal operation.

If this indicator is lit, the optic unit is too hot. If this indicator is blinking, the cooling fan has stopped. Please call service.

### LAMP indicator - NORMAL OPERATION INDICATOR IS OFF

If light is lit, the lamp has failed. See page 63-65 for lamp replacement procedure. Consult your Hitachi dealer for proper part.

If light is blinking, lamp cover is not assembled securely after replacement.

### IMPORTANT NOTES:

A small number of missing, discolored, or lit all the time dots or pixels is characteristic of TFT LCD technology due to the manufacturing process irrespective of manufacturer.



# FRONT PANEL JACKS AND CONNECTORS



The front panel jacks are provided as a convenience to allow you to easily connect a camcorder or VCR as shown in the following examples:

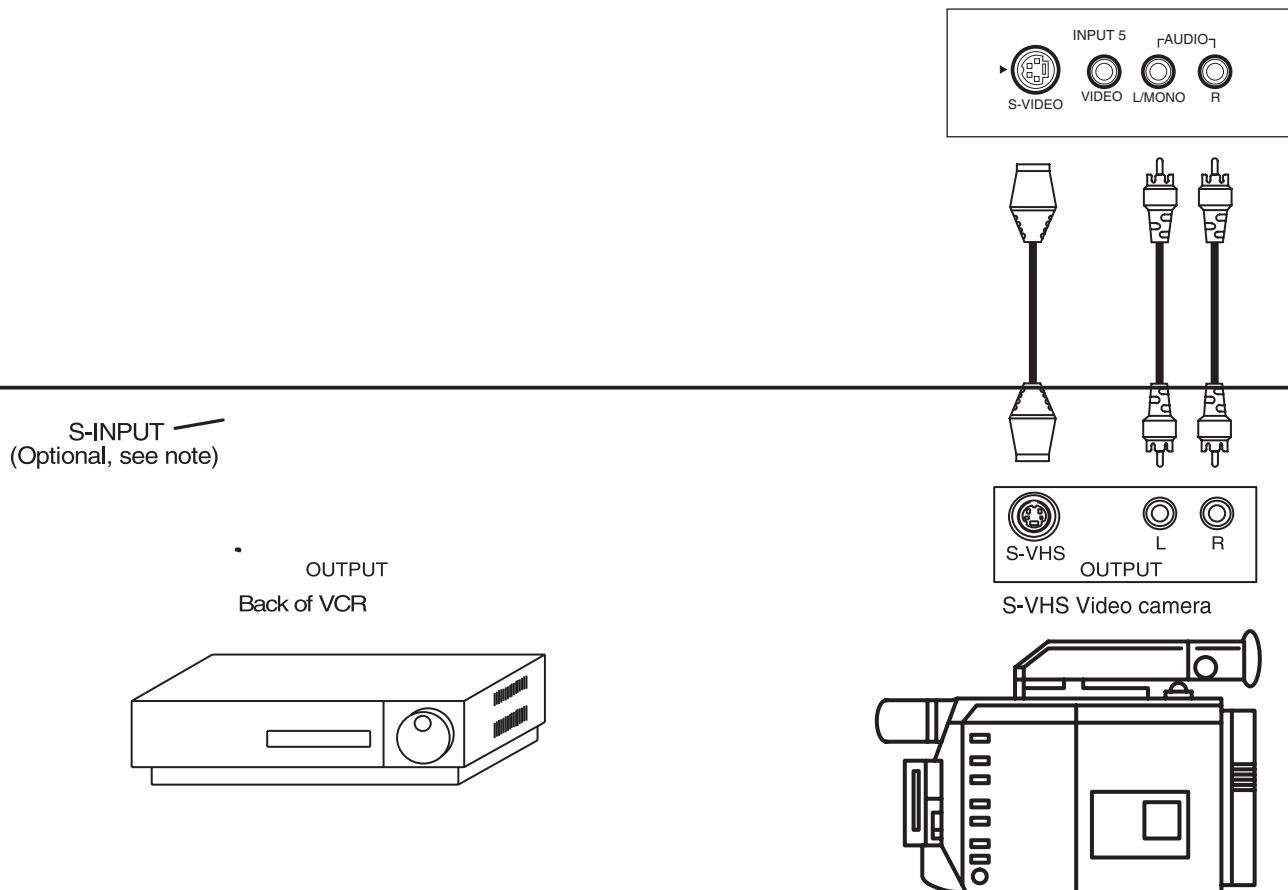

- NOTE:**
1. Completely insert connection cord plugs when connecting to front panel jacks. If you do not, the played back picture may be abnormal.
  2. If you have a S-VHS VCR, use the S-INPUT cable in place of the standard video cable.
  3. If you have a mono VCR, insert the audio cable into the left audio jack of your TV.

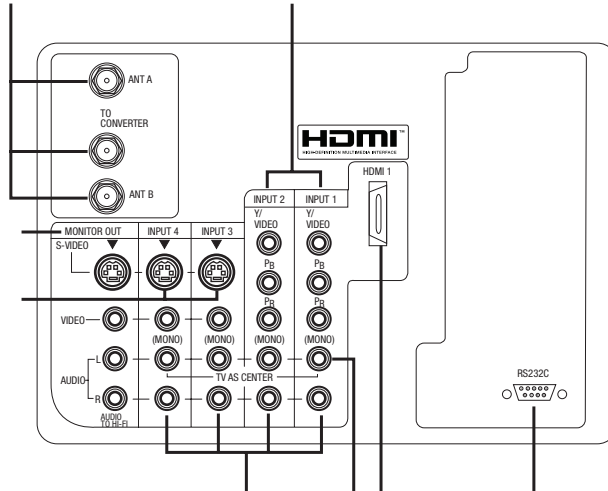

### Antenna Input/Output

The remote control allows you to switch between two separate 75-Ohm RF antenna inputs, ANT A and ANT B. ANT A input can be displayed as a main picture or sub-picture. ANT B can only be displayed as a main picture. (ANT B cannot be displayed as a sub-picture.) The antenna output labeled “TO CONVERTER” allows the ANT A connection to pass directly to a different source such as a cable box, only when ANT B is displayed as a main picture.

### Audio/Video Inputs 1, 2, 3 and 4

By using the INPUTS button and CURSOR buttons of the remote control you can select each video source. Use the audio and video inputs to connect external devices, such as VCRs, camcorders, laserdisc players, DVD players etc. (If you have mono sound, insert the audio cable into the left audio jack.)

**NOTE:** You may use VIDEO or S-VIDEO inputs to connect to INPUT 3 and 4, but only one of these inputs may be used at a time.

### MONITOR OUT

These jacks provide fixed or variable audio and video signals which are used for recording. Use the S-VIDEO Output for high quality video output (see page 65).

### S-VIDEO Inputs 3 and 4

Inputs 3 and 4 provide S-VIDEO (Super Video) jacks for connecting equipment with S-VIDEO output capability.

### Component: Y-P<sub>B</sub>P<sub>R</sub> Inputs

Inputs 1 and 2 provide Y-P<sub>B</sub>P<sub>R</sub> jacks for connecting equipment with this capability, such as a DVD player or Set Top Box. You may use composite video signal for both inputs.

**NOTES:**

1. Do not connect composite VIDEO and S-VIDEO to Input 3, 4 or 5 at the same time. S-VIDEO has priority over VIDEO input.
2. Your component outputs may be labeled Y, B-Y, and R-Y. In this case, connect the components B-Y output to the TV's P<sub>B</sub> input and the components R-Y output to the TV's P<sub>R</sub> input.
3. Your component outputs may be labeled Y-C<sub>B</sub>C<sub>R</sub>. In this case, connect the component C<sub>B</sub> output to the TV's P<sub>B</sub> input and the component C<sub>R</sub> output to the TV's P<sub>R</sub> input.
4. It may be necessary to adjust TINT to obtain optimum picture quality when using the Y-P<sub>B</sub>P<sub>R</sub> inputs (see page 38).
5. To ensure no copyright infringement, the MONITOR OUT output will be abnormal, when using the Y-P<sub>B</sub>P<sub>R</sub> jacks.
6. Input 1 and Input 2 (Y/VIDEO) can be used for composite video and component video input.



## FRONT PANEL JACKS

### HDMI (High Definition Multimedia Interface) (INPUT 1)

#### About HDMI

HDMI is the next-generation all digital interface for consumer electronics. HDMI enables the secure distribution of uncompressed high-definition video and multi-channel audio in a single cable. Because digital television (DTV) signals remain in digital format, HDMI assures that pristine high-definition images retain the highest video quality from the source all the way to your television screen.

Use the HDMI input for your external devices such as Set-Top-Boxes or DVD players equipped with an HDMI output connection.



HDMI, the HDMI logo and High-Definition Multimedia Interface are trademarks or registered trademarks of HDMI Licensing LLC.

- NOTES:**
1. The HDMI input is not intended for use with personal computers.
  2. Only DTV formats such as 1080i, 720p, 480i and 480p are available for HDMI input.

### RS232C Input

For use with third party home Audio/Video control systems which are commercially available. Please see your dealer regarding these "non Hitachi" home control systems (see page 61 to activate this input).

### TV AS CENTER (INPUTS 1-4)

These jacks are for stereo amplifiers with center signal output capability. This feature allows the TV speakers to be used as a center speaker. The TV must be set as a center channel by selecting "TV as Center" on the Internal Speakers Settings of the Audio Menu (see page 42).

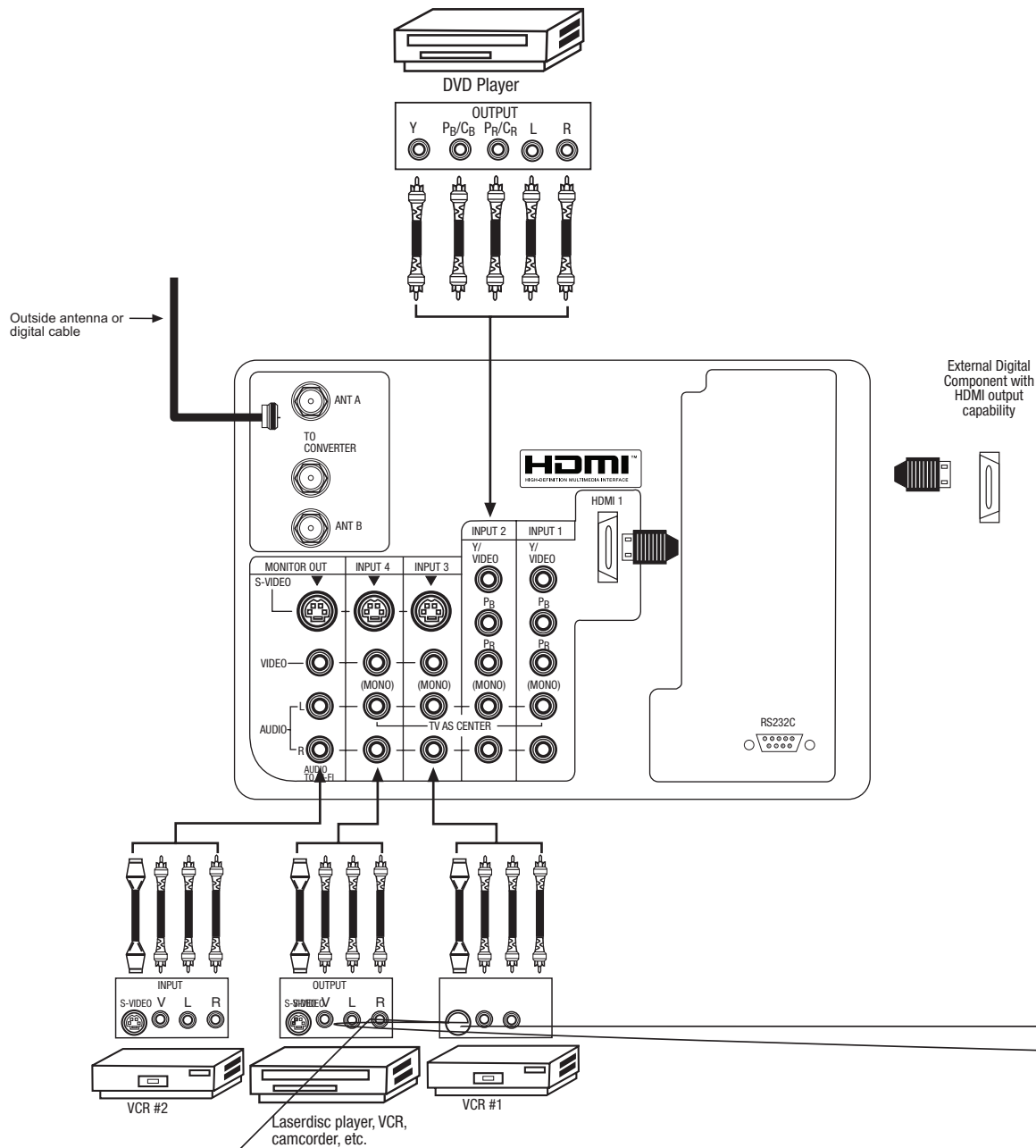

# REAR PANEL CONNECTIONS

**NOTES:**

1. Connect only 1 component to each input jack.
2. Follow connections that pertain to your personal entertainment system.
3. Inputs 1 and 2 can accommodate Composite and Component video signals.
4. Cables are not included with the purchase of this TV, except when noted as "provided".



## TIPS ON REAR PANEL CONNECTIONS

- S-VIDEO, HDMI and component connections are provided for high performance laserdisc players, VCRs etc. that have this feature. Use these connections in place of the standard video connection if your device has this feature.
- If your device has only one audio output (mono sound), connect it to the left audio jack on the television.
- Refer to the operating guide of your other electronic equipment for additional information on connecting your hook-up cables.
- A single VCR can be used for VCR #1 and VCR #2, but note that a VCR cannot record its own video or line output (INPUT: 3 in the example on page 12). Refer to your VCR operating guide for more information on line input-output connections.
- You may use VIDEO or S-VIDEO inputs to connect to Input 3, Input 4 or Input 5, but only one of these may be used at a time.
- Connect only 1 component (VCR, DVD player, camcorder, etc.) to each input jack.
- COMPONENT: Y-P<sub>B</sub>P<sub>R</sub> (Input 1 & 2) connections are provided for high performance components, such as DVD players and set-top-boxes. Use these connections in place of the standard video connection if your device has this feature. Input 1 and 2 accepts both composite and component video signals.
- Your component outputs may be labeled Y, B-Y, and R-Y. In this case, connect the components B-Y output to the TV's P<sub>B</sub> input and the components R-Y output to the TV's P<sub>R</sub> input.
- Your component outputs may be labeled Y-C<sub>B</sub>C<sub>R</sub>. In this case, connect the components C<sub>B</sub> output to the TV's P<sub>B</sub> input and the components C<sub>R</sub> output to the TV's P<sub>R</sub> input.
- You may use composite video signal for Input 1~Input 5.
- It may be necessary to adjust TINT to obtain optimum picture quality when using the Y-P<sub>B</sub>P<sub>R</sub> inputs. (See page 38)
- To ensure no copyright infringement, the MONITOR OUT output may be abnormal, when using the Y-P<sub>B</sub>P<sub>R</sub> jacks.
- When using HDMI or DVI input from a Set-Top-Box, it is recommended to use a 1080i or 720p input signal.



# CONNECTING EXTERNAL AUDIO DEVICES

Match the numbers below to the diagram for speaker placement.

- ① The television's internal speakers will act as center speaker (select Audio-Internal Speakers-TV as Center see page 42).
- ② These FRONT left and right speakers are connected to the FRONT output of a separate audio amplifier.
- ③ These REAR left and right speakers are connected to the REAR output of a separate audio amplifier.
- ④ This subwoofer is connected to the LFE/Sub Out output of a separate audio amplifier.

## REAR PANEL OF TELEVISION

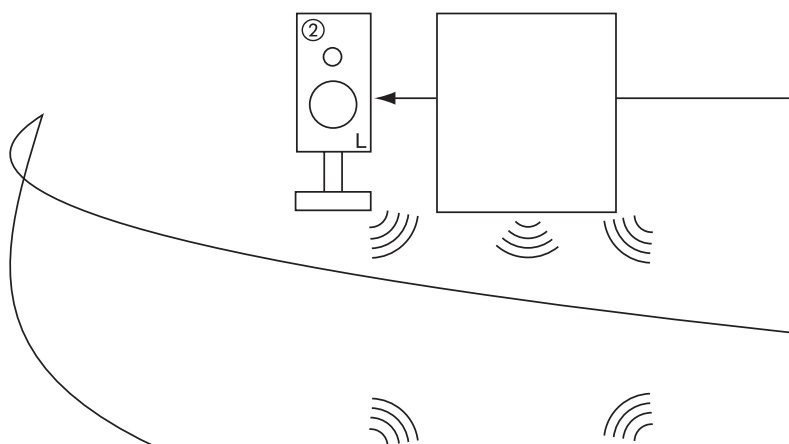
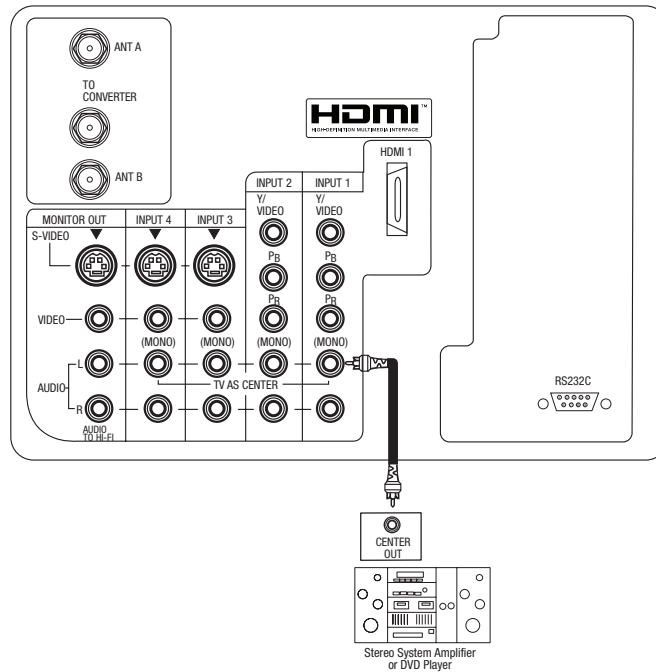

**NOTE:** 1. See page 42 for AUDIO-Internal Speakers.



# CONNECTING EXTERNAL VIDEO DEVICES

The exact arrangement you use to connect the VCR, camcorder, laserdisc player, DVD player, or HDTV Set Top Box to your TV set is dependent on the model and features of each component. Check the owner's manual of each component for the location of video and audio inputs and outputs.

The following connection diagrams are offered as suggestions. However, you may need to modify them to accommodate your particular assortment of components and features. For best performance, video and audio cables should be made from coaxial shielded wire.

## Before Operating External Video Source

Connect an external source to the INPUT terminal, then press the INPUTS button to show the INPUTS menu. Use the CURSOR buttons to select the Antenna and Input of your choice. Then press the SELECT button to confirm your choice (see page 23).

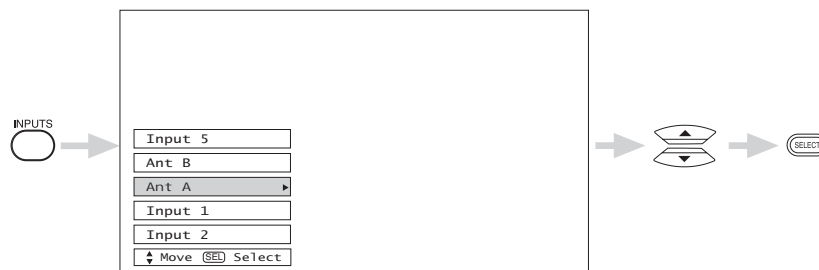

**NOTE:** When the TV is set to INPUT 1 to 5 and a video signal is not received from the VIDEO INPUT JACK on the back panel of the TV (i.e., VCR/laserdisc player, etc. is not connected or the video device is OFF), the set will appear to be OFF.

## CONNECTING A MONAURAL AUDIO SOURCE TO INPUT1~INPUT5

1. Connect the cable from the VIDEO OUT of the VCR or the laserdisc player to the INPUT (VIDEO) jack, as shown on the TV set below.
2. Connect the cable from the AUDIO OUT of the VCR or the laserdisc player to the INPUT (MONO)/L(AUDIO) jack.
3. Press the INPUTS button, then select INPUT 1 from the INPUTS menu to view the program from the VCR or the laserdisc player. The VIDEO OSD label disappears automatically after approximately four seconds.
4. Select Antenna from the INPUTS menu to return to the previous channel.

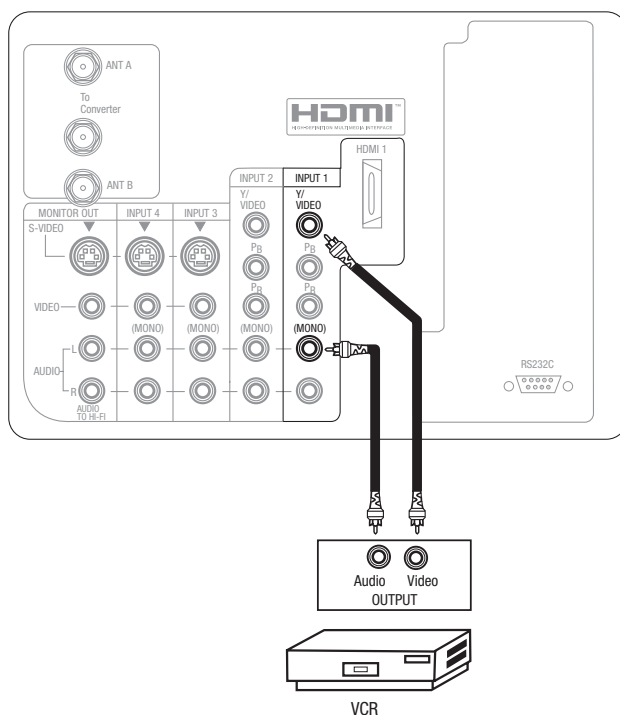

FIRST TIME USE



# CONNECTING EXTERNAL VIDEO DEVICES

FIRST TIME USE

## CONNECTING A STEREO SOURCE TO INPUT1-INPUT5

1. Connect the cable from the VIDEO OUT of the VCR or the laserdisc player to the INPUT (VIDEO) jack, as shown on the TV set below.
2. Connect the cable from the AUDIO OUT R of the VCR or the laserdisc player to the INPUT (AUDIO/R) jack.
3. Connect the cable from the AUDIO OUT L of the VCR or the laserdisc player to the INPUT (AUDIO/L) jack.
4. Press the INPUTS button, then select INPUT 3 from the INPUTS menu to view the program from the VCR or laserdisc player. The VIDEO OSD label disappears automatically after approximately four seconds.
5. Select Antenna from the INPUTS menu to return to the previous channel.

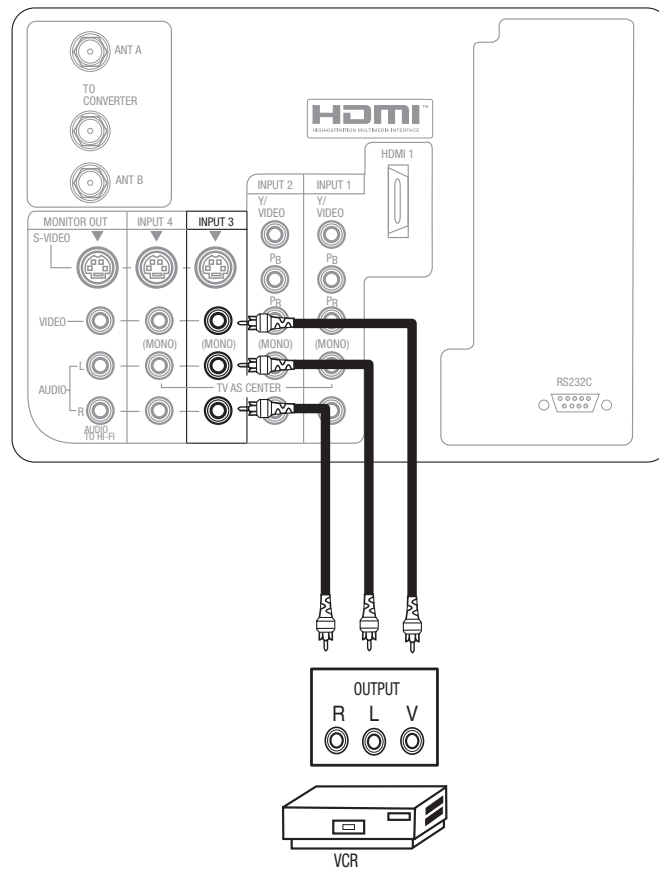

- NOTES:**
1. Completely insert the connection cord plugs when connecting to rear panel jacks. The picture and sound that is played back will be abnormal if the connection is loose.
  2. A single VCR can be used for VCR #1 and VCR #2 (see page 12), but note that a VCR cannot record its own video or line output. Refer to your VCR operating guide for more information on line input-output connections.





# CONNECTING EXTERNAL VIDEO DEVICES

FIRST TIME USE

## CONNECTING AN S-VIDEO SOURCE TO INPUT 3, 4 AND 5

1. Connect the cable from the S-VIDEO OUT of the VCR or the laserdisc player to the INPUT (S-VIDEO) jack, as shown on the TV set below.
2. Connect the cable from the AUDIO OUT R of the VCR or the laserdisc player to the INPUT (AUDIO/R) jack.
3. Connect the cable from the AUDIO OUT L of the VCR or the laserdisc player to the INPUT (AUDIO/L) jack.
4. Press the INPUTS button, then select INPUT 3 from the INPUTS menu to view the program from the VCR or laserdisc player. The VIDEO OSD label disappears automatically after approximately four seconds.
5. Select Antenna from the INPUTS menu to return to the previous channel.

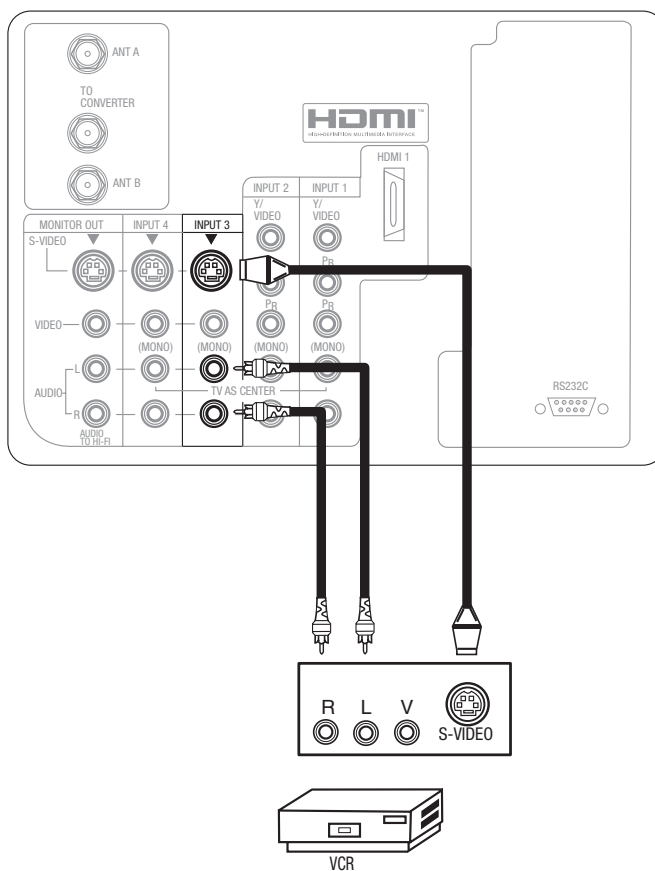

**NOTES:**

1. Completely insert the connection cord plugs when connecting to rear panel jacks. The picture and sound that is played back will be abnormal if the connection is loose.
2. A single VCR can be used for VCR #1 and VCR #2 (see page 12), but note that a VCR cannot record its own video or line output. Refer to your VCR operating guide for more information on line input-output connections.



# CONNECTING EXTERNAL VIDEO DEVICES

FIRST TIME USE

## CONNECTING A COMPONENT SOURCE WITH HDMI or DVI CAPABILITY TO INPUT 1

1. Connect the HDMI or DVI to HDMI connection cable from the output of the HDTV set top box or DVD player to the HDMI input as shown on the TV set below. When using a component with DVI output, you also have to connect the AUDIO OUT (R/L) of the component to the AUDIO IN (R/L) of INPUT 1.
2. Press the INPUTS button, then select INPUT 1 from the INPUTS menu to view the program from the HDTV set top box or DVD player. The VIDEO OSD label disappears automatically after approximately four seconds.
3. Select Antenna from the INPUTS menu to return to the previous channel.

### HDMI-HDMI

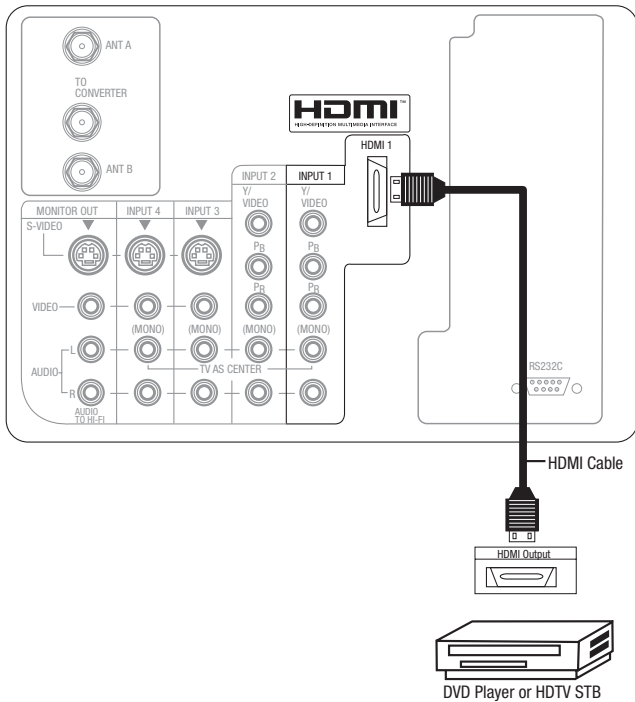

### DVI-HDMI

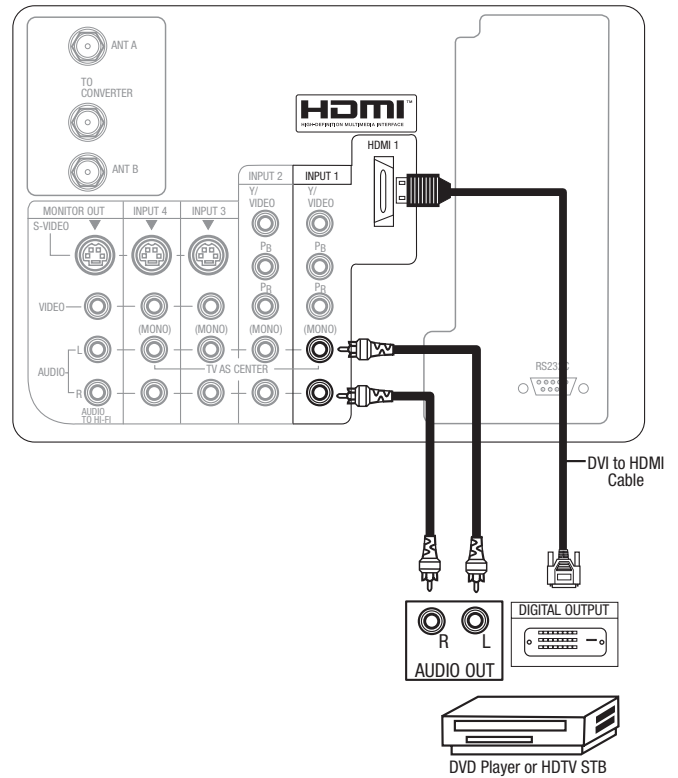

- NOTES:**
1. Completely insert the connection cord plugs when connecting to rear panel jacks. The picture and sound that is played back will be abnormal if the connection is loose.
  2. The HDMI input on INPUT 1 contains the copy protection system called High-bandwidth Digital Content Protection (HDCP). HDCP is a cryptographic system that encrypts video signals when using HDMI connections to prevent illegal copying of video contents.
  3. HDMI is not a "NETWORK" technology. It establishes a one-way point-to-point connection for delivery of uncompressed video to a display.
  4. The connected digital output device controls the HDMI interface so proper set-up of device user settings determines final video appearance.



# CONNECTING EXTERNAL VIDEO DEVICES

FIRST TIME USE

## CONNECTING A COMPONENT SOURCE TO INPUT 1 OR 2: Y-P<sub>B</sub>P<sub>R</sub>.

1. Connect the cable from the Y OUT of the Laserdisc/DVD player or HDTV set top box to the INPUT (Y) jack, as shown on the TV set below.
2. Connect the cable from the C<sub>B</sub>/P<sub>B</sub> OUT or B-Y OUT of the Laserdisc/DVD player or HDTV set top box to the INPUT (P<sub>B</sub>) jack.
3. Connect the cable from the C<sub>R</sub>/P<sub>R</sub> OUT or R-Y OUT of the laserdisc/DVD player or HDTV set top box to the INPUT (P<sub>R</sub>) jack.
4. Connect the cable from the AUDIO OUT R of the Laserdisc/DVD player or HDTV set top box to the INPUT (AUDIO/R) jack.
5. Connect the cable from the AUDIO OUT L of the Laserdisc/DVD player or HDTV set top box to the INPUT (AUDIO/L) jack.
6. Press the the INPUTS button, then select INPUT 2 from the INPUTS menu to view the program from the Laserdisc/DVD player or HDTV set top box. The VIDEO OSD label disappears automatically after approximately four seconds.
7. Select Antenna from the INPUTS menu to return to the previous channel.

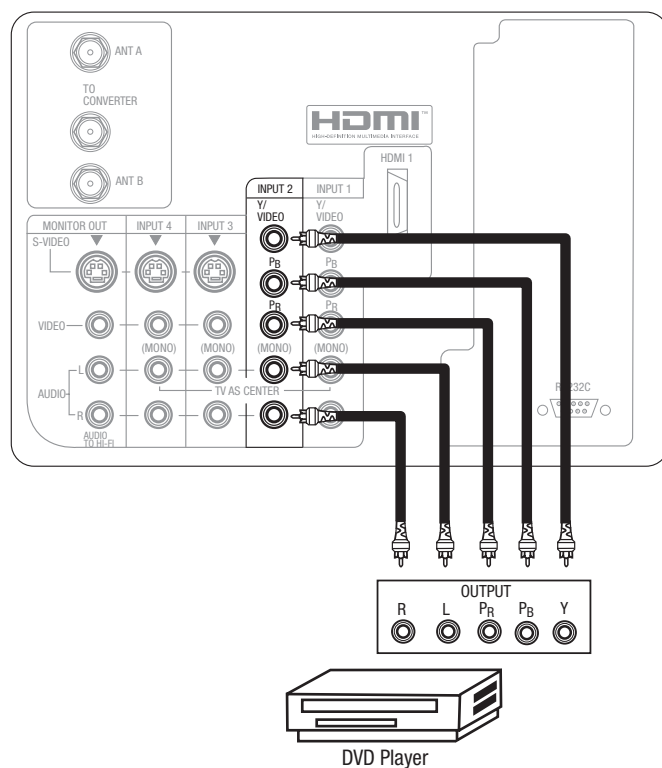

- NOTES:**
1. Completely insert the connection cord plugs when connecting to rear panel jacks. The picture and sound that is played back will be abnormal if the connection is loose.
  2. See page 13 for tips on REAR PANEL CONNECTIONS.



# THE REMOTE CONTROL

In addition to controlling different types of VCRs, CATV (Cable Television) keys are grouped together.

To operate your TV, point the remote at the television.

To operate your VCR, point the remote at your VCR (see page 32).

To operate your cable box, point the remote at the cable box. The remote will now control your cable box.

To operate your set-top-box, point the remote at the set-top-box and press the SAT button. To operate your satellite receiver, press the SAT button to program your satellite receiver.

To operate your DVD player, point the remote at the DVD player and press the DVD button. The remote will now control your DVD player (see page 32).

## THE REMOTE CONTROL

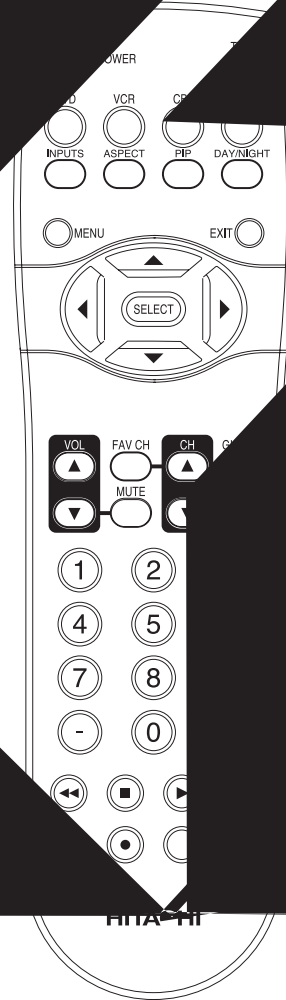

# HOW TO USE THE REMOTE TO CONTROL YOUR LCD REAR PTV

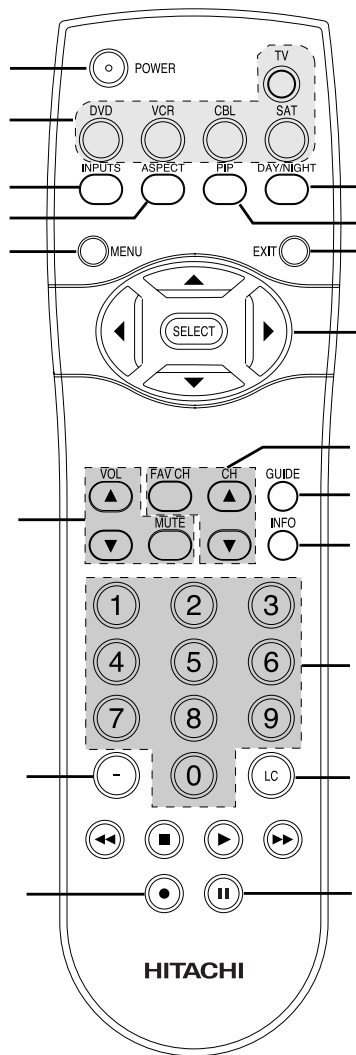

THE REMOTE CONTROL

## POWER button

Press this button to turn the TV set on or off when the remote is in TV mode. (See page 20 for instructions on how to set the remote control to TV mode.)

## MODE buttons

These buttons allow the remote to control your TV, VCR, DVD, Cable box (CBL)/Satellite box (SAT) depending on which button is pressed.

## PAUSE button

Press the PAUSE button to freeze the picture. Press the EXIT button to return the picture to motion. Press the PAUSE button repeatedly to cycle through the three different freeze modes (see page 28).

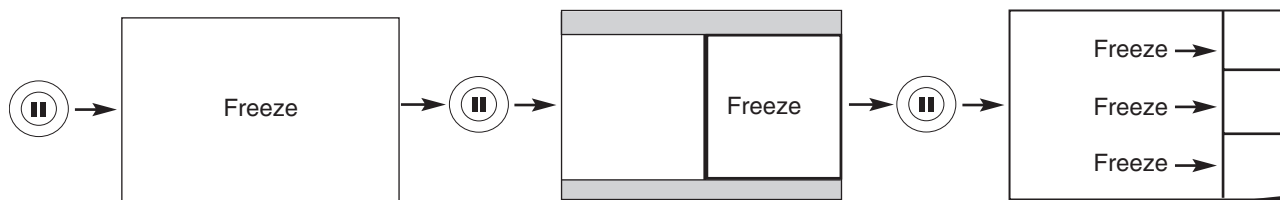

# HOW TO USE THE REMOTE TO CONTROL YOUR LCD REAR PTV



## ASPECT button

Press this button to quickly change the picture format ASPECT ratio.

Depending on the input signal format received, the picture format ratio allows you to adjust the images through the following options.

- 4:3 STANDARD Use this aspect mode to display conventional (4:3) images. Side panels (gray areas) are placed to the left and right of the image to preserve the original aspect ratio of the source.
- 4:3 EXPANDED Use this aspect mode to display conventional (4:3) sources by linearly increasing image expansion from the center towards the edges of the display area in order to fill it.
- 4:3 Zoom1/Zoom2 Use these aspect modes to zoom in on conventional (4:3) sources.
- 16:9 STANDARD Use this aspect mode to display 16:9 sources like HDTV and DVD's preserving the original 16:9 aspect ratio.
- 16:9 Zoom Use this aspect to Zoom-in once while in 16:9 aspect.

### (1) Antenna Analog Channels

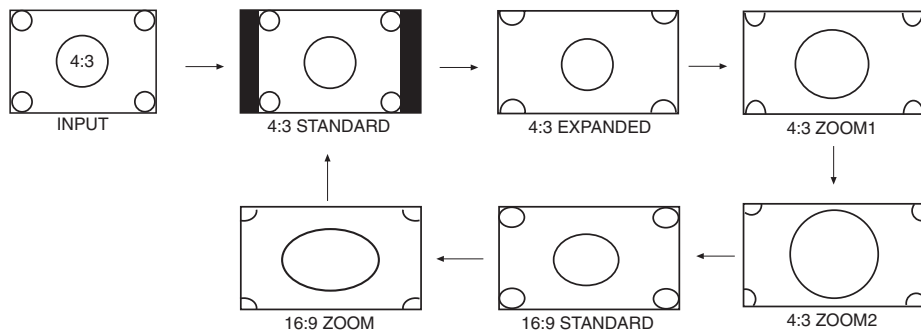

### (2) 480P Input

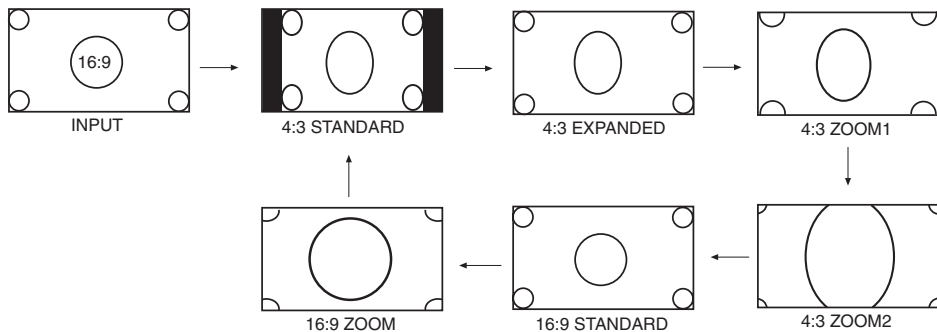

### (3) HDMI/720P/1080i Input

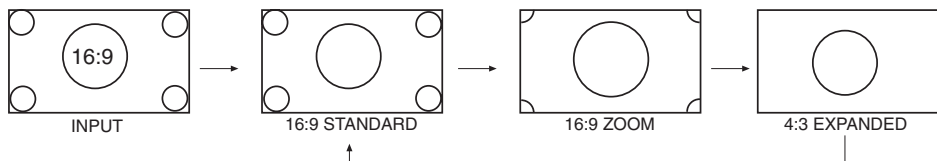

THE REMOTE CONTROL

- NOTES:**
1. The Aspect Style setting you select for an ANT input will automatically be set for the other ANT inputs. However, all five video inputs have independent Aspect Style settings.
  2. Vertical position adjustments are directly available when you choose 4:3 EXPANDED/ZOOM1/ZOOM2 or 16:9 ZOOM aspect style (see also page 43).

# HOW TO USE THE REMOTE TO CONTROL YOUR LCD REAR PTV



## INPUTS button

When the remote control is in TV mode, press this button to access the INPUTS menu. Use the CURSOR and SELECT buttons to select the inputs that are being used. Pressing the INPUTS button repeatedly will also cycle through the Inputs menu items. Then press the SELECT button to select.

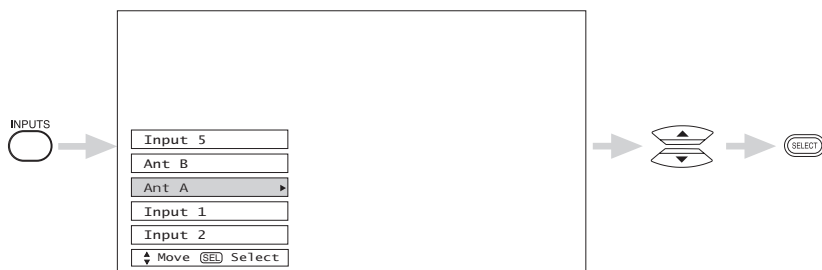

Ant B	Select to choose Antenna B.
Ant A	Select to choose Antenna A.
Input 1	Select to choose Input 1 for Video 1.
Input 2	Select to choose Input 2 for Video 2.
Input 3	Select to choose Input 3 for Video 3.
Input 4	Select to choose Input 4 for Video 4.
Input 5	Select to choose Input 5 for Video 5.



# HOW TO USE THE REMOTE TO CONTROL YOUR LCD REAR PTV

## PICTURE-IN-PICTURE button

See separate section on pages 26-28 for a description.

## MENU button

The MENU button will start the On-Screen Display.

## GUIDE button [Cable Box (CBL), Satellite Receiver (SAT)/Set-Top-Box (STB) mode only]

The use of this button is only applicable when the remote control is in (CBL) and (SAT/STB) mode. Press this button to access the Channel Guide of the (CBL), and (SAT/STB).

## EXIT button

This button will exit all On-Screen Displays.

## CURSOR buttons/SELECT button

All the On-Screen Display features can be set or adjusted by using the CURSOR buttons and the SELECT button, except for numeric entries. Press the CURSOR buttons toward desired direction and press the SELECT button to select.

## INFO button

Press this button when you want to check the channel being received, the picture source, if the channel has stereo (ST) or second audio program (SAP), the time, CHANNEL ID and if the TIMER is set.

THE REMOTE CONTROL

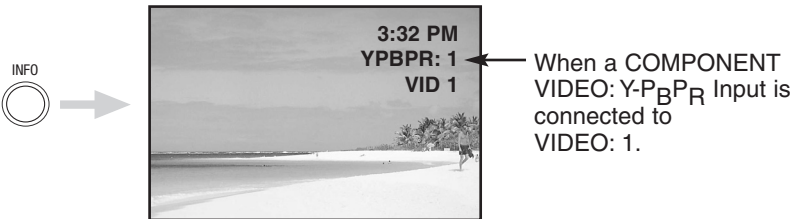
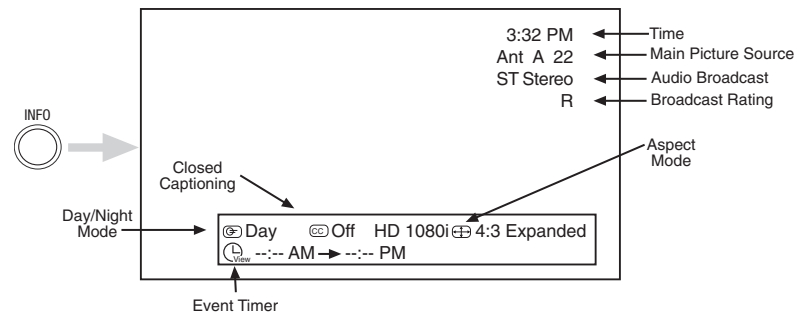

- NOTES:**
1. The Sleep Timer info will show momentarily after releasing INFO button.
  2. Press the INFO button again or the EXIT button to return to normal viewing.



# HOW TO USE THE REMOTE TO CONTROL YOUR LCD REAR PTV



## VOLUME (VOL), MUTE button

Press the VOLUME button (▲ or ▼) until you obtain the desired sound level.

To reduce the sound to one half of normal volume (SOFT MUTE) to answer the telephone, etc., press the MUTE button. Press the MUTE button again to turn the sound off completely (MUTE). To restore the sound, press the MUTE button one more time, or VOL Up (▲).



Closed Captioning will display automatically when MUTE/SOFT MUTE is on and Closed Caption is set to AUTO (see page 60).

When the TV power is turned off at a volume level 31 or greater, the volume level will default to 30 when the TV is turned on. However, if it is set to a level 30 or less, the volume level will be at the level it was set when the TV is turned ON.

## CHANNEL SELECTOR/FAVORITE CHANNEL (FAV CH) buttons

The CHANNEL SELECTOR buttons are used to select channels, lock access code, etc. Use the CHANNEL SELECTOR buttons to enter one, two, or three numbers to select channels. Enter "0" first for channels 1 to 9, or simply press the single digit channel you wish to tune then wait a few seconds for the TV to tune. Channel selection may also be performed by CHANNEL (CH) up (▲) or CHANNEL (CH) down (▼).

Press the FAV CH button to switch to Favorite (FAV) channel mode. You will know you are in Favorite Channel mode when (FAV) is displayed and the displayed channel is GREEN. Press it again to return to your regular tuned channels. You can add any channel to your Favorite channel list by pressing and holding down the FAV CH button until the displayed channel turns from WHITE to highlighted GREEN. You can also delete a channel from your favorite channel list by pressing and holding down the FAV CH button until the displayed channel turns highlighted GREEN to WHITE.



## (-) DASH button

The (-) DASH button can only be used when the remote control is in Satellite (SAT) mode.

## LAST CHANNEL (LC) button

Press this button to toggle between the current and last channel viewed.

## RECORD button

Press twice (2 times) to record programs when the remote is in VCR mode.



# PICTURE-IN-PICTURE (PIP)

Your HITACHI LCD Rear PTV incorporates Two Tuner technology designed for improved viewing enjoyment. This Two Tuner feature allows you to view antenna inputs on both the main picture and sub-picture simultaneously, with separate tuning control for each.

ANT A input can be viewed as both the main picture and the sub-picture simultaneously. ANT B can only be viewed as a main picture. To select between main picture and PIP sub-picture tuning, use the CURSOR buttons on the remote. The green highlighted channel display will move with every press of the CURSOR button ◀ or ▶.

The Picture-in-Picture feature is convenient when you want to watch more than one program at the same time. You can watch a TV program while viewing other programs from any of the video inputs.

THE REMOTE CONTROL

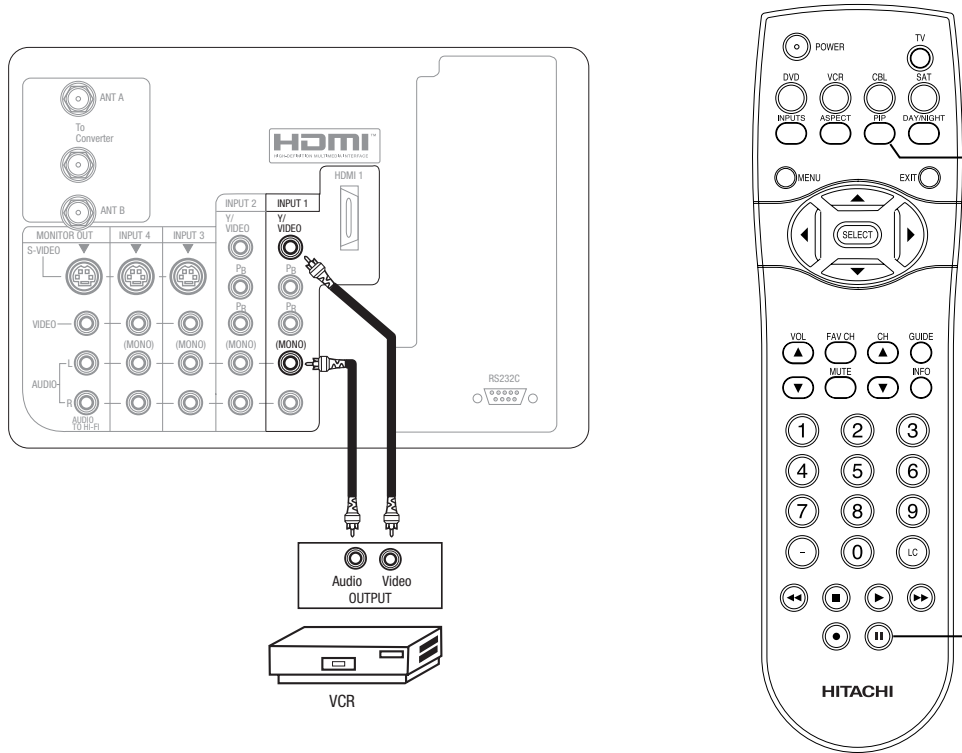

Use above connection to view VCR program as a sub-picture while viewing another program as main picture (ANT A, ANT B, INPUT:2, INPUT:3, INPUT:4, or INPUT:5). You may also view the VCR program as a main picture while viewing another program as a sub-picture (ANT A, INPUT:2, INPUT:3, INPUT:4 or INPUT:5).

### PIP button

Press the PIP button and a sub-picture will appear in one of the four different modes (POP, PIP, SPLIT or SURF), depending on the INPUT signal. To change the PIP mode, use the PIP button to cycle through the four different modes. Press the EXIT button to return to normal viewing from any PIP mode.

### POP MODE PICTURE-IN-PICTURE

POP Mode PIP displays the sub-picture outside of the main picture. Use the CURSOR button ▲ or ▼ to move the sub-picture. This feature is not available with a 1080i component input or Digital signal 16x9 Format. Please refer to the PICTURE-IN-PICTURE MODES Table (see page 28).

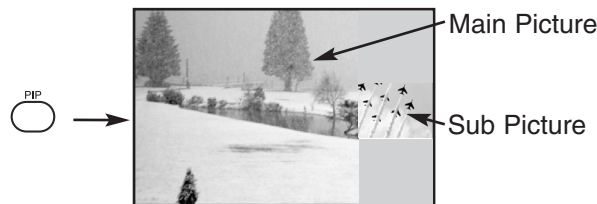

- NOTES:**
1. PIP MODE Picture-in-Picture is only available with a 1080i component or digital signal 4x3 Format.
  2. Use the CURSOR button ◀ or ▶ to enable the sub-picture sound.



# PICTURE-IN-PICTURE (PIP)

## PIP MODE PICTURE-IN-PICTURE

This feature is only available with a 1080i component input or Digital signal 16x9 Format. To prevent a pattern burn, occasionally move the sub-picture using the CURSOR buttons.

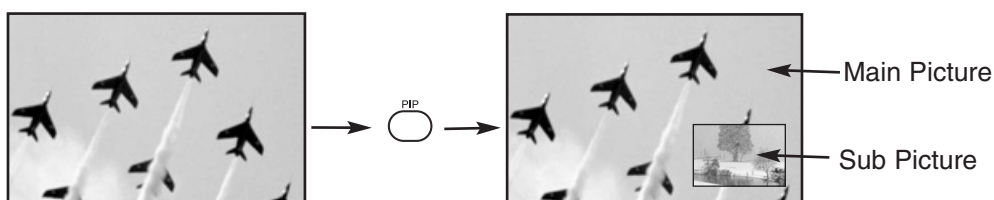

## SPLIT MODE PICTURE-IN-PICTURE

Split Mode PIP displays the main picture and sub-picture evenly on the screen.



## SURF MODE PICTURE-IN-PICTURE

Surf Mode PIP automatically scans all active channels (those set in memory) and displays them as PIP sub-pictures or Thumbnail channels. Press the SELECT button to stop on a chosen channel. Use the remote CURSOR buttons ◀, ▶, ▲ and ▼ to navigate the Thumbnail. Press the EXIT button to enable your chosen channel and return to normal viewing.



**NOTE:** Press the SELECT button to stop the Surf mode or channel scan. Press the SELECT button again to resume Surf mode or channel scan.

PICTURE-IN-PICTURE (PIP) MODES

PIP Mode	Sub		NTSC	480i	480p	720p	1080i
	Main						
POP	NTSC	Yes	Yes	-	-	-	Yes
	480i	Yes	Yes	-	-	-	Yes
PIP 4x3	1080i	Yes	Yes	-	-	-	-
PIP 16x9	1080i	Yes	Yes	-	-	-	Yes
SPLIT	NTSC	Yes	Yes	Yes	Yes	Yes	Yes
	480i	Yes	Yes	Yes	Yes	Yes	Yes
	480p	Yes	Yes	Yes	Yes	Yes	Yes
	720p	Yes	Yes	Yes	Yes	Yes	Yes
	1080i	Yes	Yes	Yes	Yes	Yes	Yes
12 Pix	-	Ant A/B	-	-	-	-	-



# PICTURE-IN-PICTURE (PIP)

## PAUSE button

If you wish to freeze the sub-picture, press the PAUSE button. This is convenient when trying to write down the address for a mail order company, recording statistics for a sporting event, etc. To return the picture to motion, press the EXIT button. Press the PAUSE button repeatedly to toggle between FREEZE modes (Main Freeze, SPLIT and STROBE).

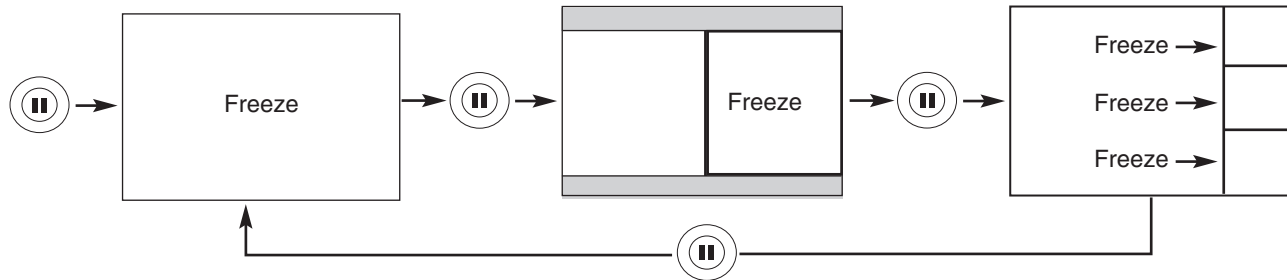

## MAIN FREEZE

Press the PAUSE button to freeze one frame of the picture you are currently viewing and the frozen frame will show in the Main Picture. Press the EXIT button to return to normal viewing. This feature is useful for freezing a picture frame with addresses.

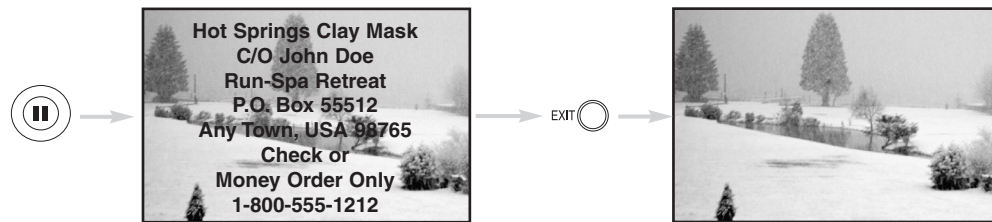

## SPLIT FREEZE

Press the PAUSE button to freeze the picture you are currently viewing (only the right sub-picture will freeze). Press the EXIT button to return to normal viewing.

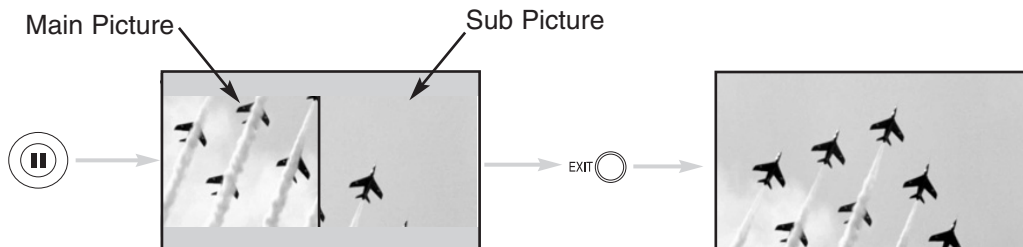

## STROBE FREEZE

Press the PAUSE button to freeze three frames of the picture you are currently viewing (only the 3 sub-pictures will freeze). Press the EXIT button to return to normal viewing. This feature is useful for viewing a moving picture that has many details, for example, a close play in a sporting event or a golf swing.

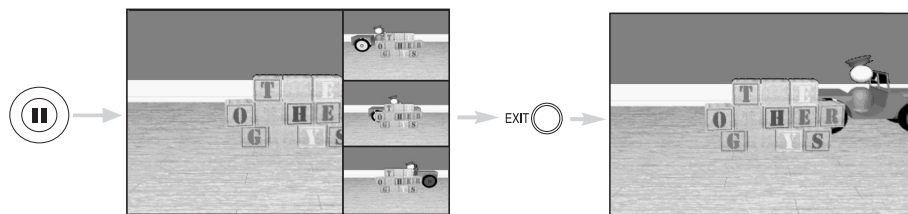

- NOTES:**
1. The default FREEZE mode is the MAIN freeze followed by the SPLIT freeze and then the STROBE freeze. The last Freeze mode you selected before you pressed the EXIT button will be the one that comes up after pressing the PAUSE button again.
  2. Each freeze frame is delayed about 0.1 (1/10) second.
  3. Strobe Freeze is not available in 480p/720p/1080i inputs.

# USING THE REMOTE TO CONTROL CABLE BOX FUNCTIONS



## Operating the precoded function for your cable box.

This remote is designed to operate different types of cable boxes. You must first program the remote to match the remote system of your cable box (refer to page 33 for pre-codes).

1. Turn ON your cable box.
2. Aim the remote control at the front of your cable box.
3. To switch to Cable (CBL) pre-coded mode, press and release the CABLE (CBL) button.
4. Hold down the CBL button on the remote and enter the two digit preset code that matches your cable box as shown on page 33. Release the CBL button.
5. Aim the remote at the cable box and press the POWER button. The remote will turn off your cable box when the correct two digit preset code is entered. When this occurs, the remote control is programmed for your cable box. If the cable box does not turn off, try a different two digit preset code.
6. The remote will now control your Cable box.

### NOTES:

1. If your cable box cannot be operated after performing the above procedures, your cable box code has not been precoded into the remote.
2. In the unlikely event that your cable box cannot be operated after performing the above procedures, please consult your cable box operating guide.
3. The remote control will remember the codes you have programmed until the batteries are removed from the remote control. After replacing the batteries repeat the entire programming procedure as stated above.

### CABLE (CBL) button

This button allows the remote to control your cable box by setting it to CABLE mode.

### PRECODED CABLE BOX buttons

These buttons transmit the chosen precoded cable codes.

### EXCLUSIVE TV buttons

These buttons are for operating the TV.

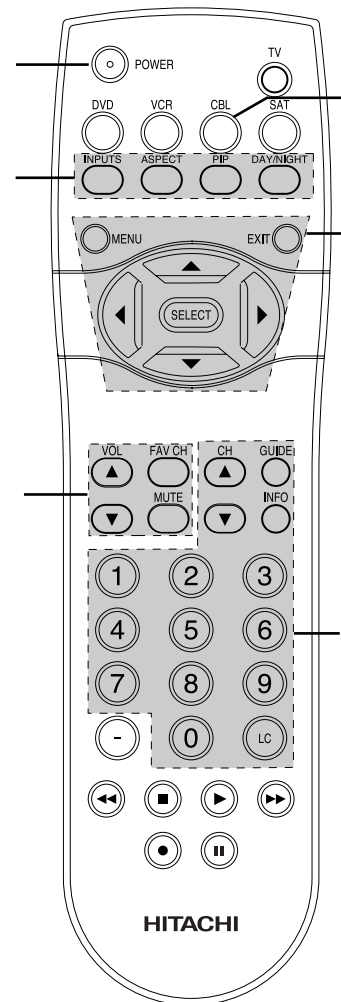

THE REMOTE CONTROL

MY CABLE BOX CODE IS: \_\_\_\_\_

**NOTE:** Refer to instruction manual of the Cable Box for operation of the buttons exclusively for the Cable Box.



# USING THE REMOTE TO CONTROL SET-TOP-BOX/SATELLITE RECEIVER FUNCTIONS

## Operating the precoded function for your set-top-box/satellite receiver.

This remote is designed to operate different types of set-top-box/satellite systems. You must first program the remote to match the remote system of your set-top-box/satellite systems (refer to page 33 for pre-codes).

1. Turn ON your set-top-box/satellite systems.
2. Aim the remote control at the front of your set-top-box/satellite systems.
3. To switch to set-top-box/satellite (STB) pre-coded mode, press and release the SAT button.
4. Hold down the SAT button on the remote and enter the two digit preset code that matches your set-top-box/satellite receiver as shown on page 33. Release the SAT button.
5. Aim the remote at the set-top-box/satellite receiver and press the POWER button. The remote will turn off your set-top-box/satellite receiver when the correct two digit preset code is entered. When this occurs, the remote control is programmed for your set-top-box/satellite receiver. If the set-top-box/satellite receiver does not turn off, try a different two digit preset code.
6. The remote will now control your set-top-box/satellite receiver.

THE REMOTE CONTROL

### NOTES:

1. If your set-top-box/satellite receiver cannot be operated after performing the above procedures, your set-top-box/satellite receiver code has not been precoded into the remote.
2. In the unlikely event that your set-top-box/satellite receiver cannot be operated after performing the above procedures, please consult your set-top-box/satellite receiver operating guide.
3. The remote control will remember the codes you have programmed until the batteries are removed from the remote control. After replacing the batteries repeat the entire programming procedure as stated above.

### SAT (Set-Top-Box/Satellite) button

This button allows the remote to control your set-top-box/satellite receiver by setting it to SET-TOP-BOX/SATELLITE mode.

### PRE-CODED SET-TOP-BOX/SATELLITE RECEIVER buttons

These buttons transmit the chosen pre-coded set-top-box/satellite codes.

### EXCLUSIVE TV buttons

These buttons are for operating the TV.

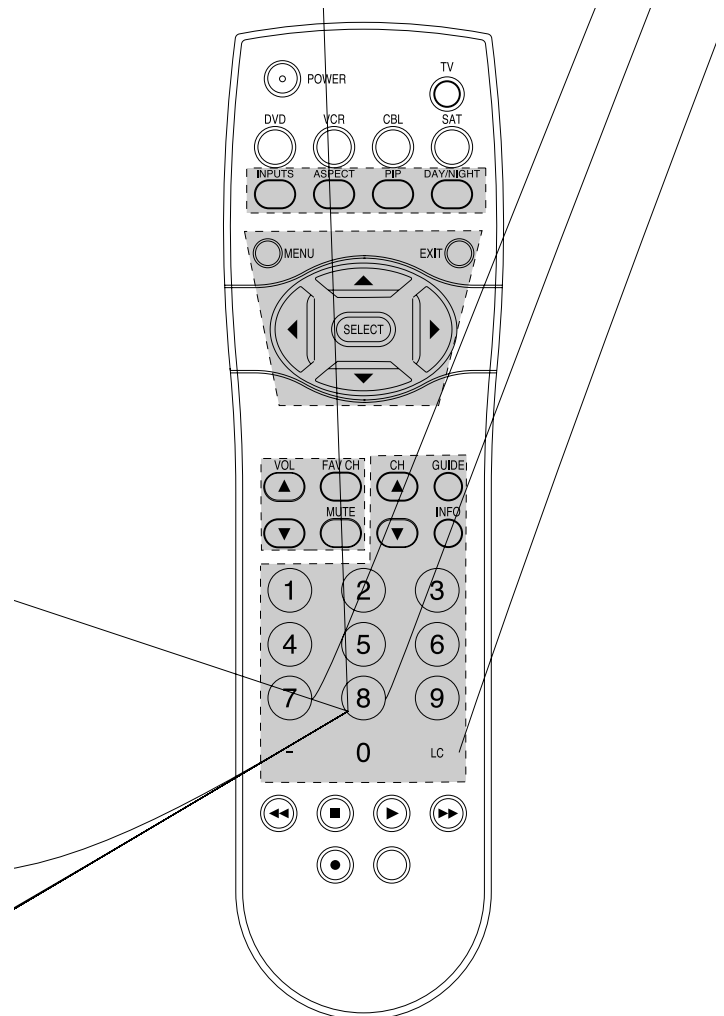

# USING THE REMOTE TO CONTROL DVD FUNCTIONS



## Operating the precoded function for your DVD player.

This remote is designed to operate different types of DVD players. You must first program the remote to match the remote system of your DVD player (refer to page 33 for pre-codes).

1. Turn ON your DVD player.
2. Aim the remote control at the front of your DVD player.
3. To switch to DVD pre-coded mode, press and release the DVD button.
4. Hold down the DVD button on the remote and enter the two digit preset code that matches your DVD player, as shown on page 33. Release the DVD button.
5. Aim the remote at the DVD player and press the POWER button. The remote will turn off your DVD player when the correct two digit preset code is entered. When this occurs, the remote control is programmed for your DVD player. If the DVD player does not turn off, try a different two digit preset code.
6. The remote will now control your DVD player.
7. You will need to set the display type of your DVD player to 16:9 widescreen.

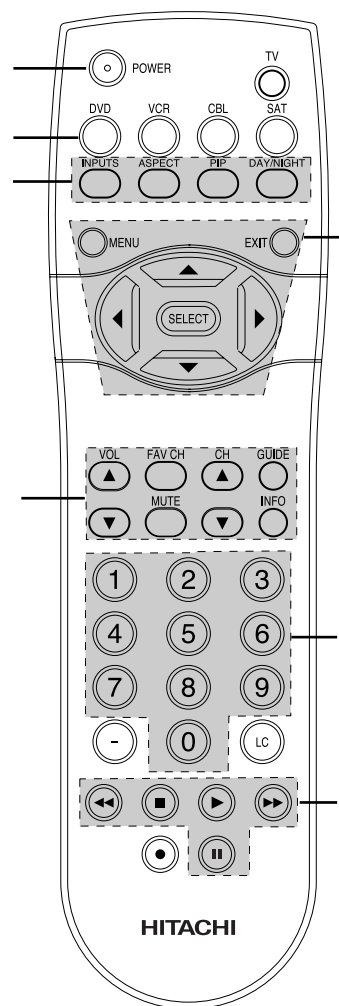

THE REMOTE CONTROL

### NOTES:

1. If your DVD player cannot be operated after performing the above procedures, your DVD player's code has not been precoded into the remote.
2. In the unlikely event that your DVD player cannot be operated after performing the above procedures, please consult your DVD player operating guide.
3. The remote control will remember the codes you have programmed until the batteries are removed from the remote control. After replacing the batteries repeat the entire programming procedure as stated above.

### DVD button

This button allows the remote to control your DVD player by setting it to DVD mode.

### PRECODED DVD Buttons

These buttons transmit the chosen precoded DVD codes.

### EXCLUSIVE TV Buttons

These buttons are for operating the TV.

MY DVD PLAYER CODE IS: \_\_\_\_\_

**NOTE:** Refer to instruction manual of the DVD player for operation of the buttons exclusively for the DVD player.





# USING YOUR REMOTE TO CONTROL VCR FUNCTIONS

## Operating the precoded function for your VCR.

This remote is designed to operate different types of VCRs. You must first program the remote to match the remote system of your VCR (refer to page 33 for pre-codes).

1. Turn ON your VCR.
2. Aim the remote control at the front of your VCR.
3. To switch to VCR pre-coded mode, press and release the VCR button.
4. Hold down the VCR button on the remote and enter the two digit preset code that matches your VCR, as shown on page 33. Release the VCR button.
5. Aim the remote at the VCR and press the POWER button. The remote will turn off your VCR when the correct two digit preset code is entered. When this occurs, the remote control is programmed for your VCR. If the VCR does not turn off, try a different four digit preset code.
6. The remote will now control your VCR.

THE REMOTE CONTROL

### NOTES:

1. If your VCR cannot be operated after performing the above procedures, your VCR's code has not been precoded into the remote.
2. In the unlikely event that your VCR cannot be operated after performing the above procedures, please consult your VCR operating guide.
3. The remote control will remember the codes you have programmed until the batteries are removed from the remote control. After replacing the batteries repeat the entire programming procedure as stated above.
4. Press the Record button twice to record.

### VCR button

This button allows the remote to control your VCR player by setting it to VCR mode.

### PRECODED VCR Buttons

These buttons transmit the chosen precoded VCR codes.

### EXCLUSIVE TV Buttons

These buttons are for operating the TV.

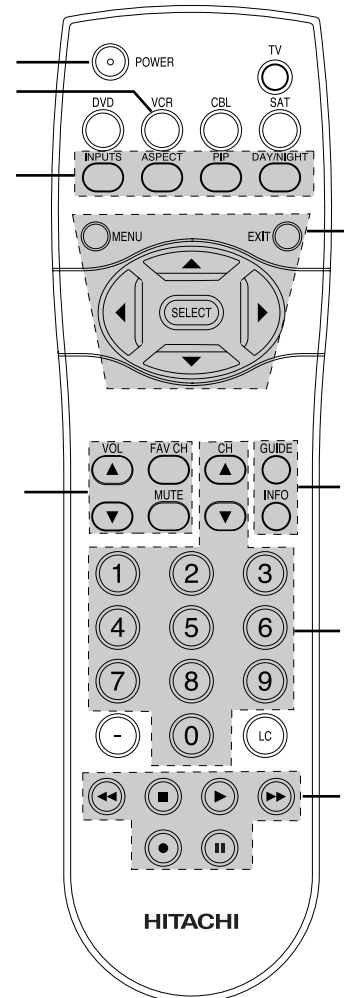

MY VCR CODE IS: \_\_\_\_\_

**NOTE:** Refer to instruction manual of the VCR for operation of the buttons exclusively for the VCR.



# VCR, CABLE, SATELLITE, AND DVD REMOTE



## **VCR BRAND..... CODE**

EMERSON . . . . .	20, 21, 22, 23, 24
FISHER . . . . .	34, 37, 38, 39
HITACHI . . . . .	00, 01, 02, 03, 04, 05, 06
JVC . . . . .	49, 50, 51
MAGNAVOX . . . . .	12, 13
MITSUBISHI . . . . .	27, 28, 29, 30
NEC . . . . .	40, 41
PANASONIC . . . . .	10, 11
SAMSUNG . . . . .	25, 26
SHARP . . . . .	31, 32
SONY . . . . .	07, 08, 09

## **DVD BRAND..... CODE**

APEX . . . . .	10
GO VIDEO . . . . .	09
HITACHI . . . . .	00
KENWOOD . . . . .	11
PANASONIC . . . . .	02
PIONEER . . . . .	03
RCA . . . . .	04
SAMSUNG . . . . .	06
SANYO . . . . .	07
SONY . . . . .	01
TOSHIBA . . . . .	05

## **CABLE BRAND . . . . . CODE**

HAMLIN . . . . .	22, 23, 24, 25
JERROLD . . . . .	00, 01, 02, 03, 04, 05, 06, 07
OAK . . . . .	26, 27, 28
PANASONIC . . . . .	18, 19, 20
PIONEER . . . . .	13, 14
SCIENTIFIC ATLANTA . . . . .	08, 09, 10
TOCOM . . . . .	15, 16
ZENITH . . . . .	11, 12

## **DIGITAL CABLE BRAND... CODE**

PIONEER . . . . .	29
SCIENTIFIC ATLANTA . . . . .	30

## **SATELLITE BRAND . . . . . CODE**

ECOSTAR . . . . .	03
HITACHI . . . . .	00
HUGHES . . . . .	04
RCA . . . . .	01
SONY . . . . .	02

## **SET TOP BOX BRAND . . . . . CODE**

PANASONIC . . . . .	05
RCA . . . . .	06
SAMSUNG . . . . .	07
ZENITH . . . . .	08

# ON-SCREEN DISPLAY (OSD)

1. Press MENU on the remote control to display the different features on your HITACHI LCD TV.
2. Press the CURSOR buttons to highlight a different feature.
3. Press EXIT on the remote control to quickly exit from a menu.

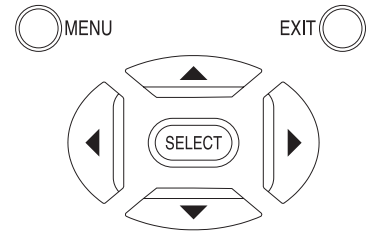

This part of the screen shows which selections are available.

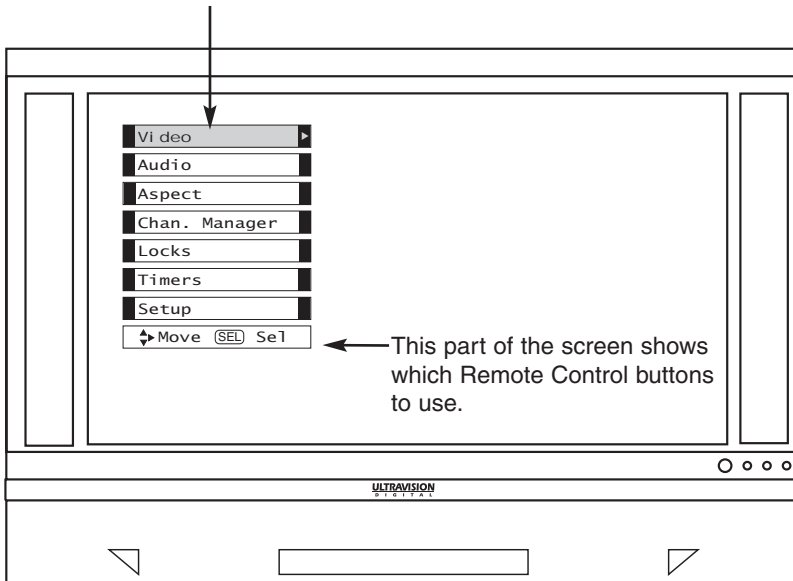

This part of the screen shows which Remote Control buttons to use.

# ON-SCREEN DISPLAY (OSD)

## Video

Picture Mode	Select between the two picture modes; Day and Night.
Contrast	Adjust contrast.
Brightness	Adjust brightness.
Color	Adjust color.
Tint	Adjust tint.
Sharpness	Adjust sharpness.
Color Temperature	Set this to High for less intense color with more blue, set to Medium for natural color, set to Standard for standard colors or Black and White for more reddish color.
Black Enhancement	Adjust shadow detail in dark screens.
Contrast Mode	Choose between Dynamic for darker images more in the level of black, Normal for a balanced white to black levels and Auto for automatic contrast selection.
Reset Video Settings	Choose the Reset Video settings.
Color Management	Adjust and balance individual colors to make either deeper or more pure according to preference.
Color Decoding	Adjust the percentage of Red, Green and Color according to preference.
Auto Color	The AUTO COLOR function automatically monitors and adjusts the color to maintain constant color levels even after a program or channel changes. It also maintains natural flesh tones while preserving fidelity of background colors.
Noise Reduction	Reduces conspicuous noise in the picture.
Auto Movie Mode	Turn ON/OFF the 3:2 Pulldown detection feature.

## Audio

Treble	Adjust the treble.
Bass	Adjust the bass.
Balance	Adjust the balance.
SRS	Select SRS settings (Off, Wide, Normal)
BBE	Select BBE settings (Off, Soft, Hard)
Audio Source	Select between three Audio Sources.
Internal Speakers	Select internal or external speakers.
Auto Noise Cancel	Eliminates the noise between stations.
Perfect Volume	Adjust volume in fixed setting.
Loudness	Adjust Loudness.

## Aspect

4:3 Standard	} Choose the picture format aspect ratio.
4:3 Expanded	
4:3 Zoom 1	
4:3 Zoom 2	
16:9 Standard	
16:9 Zoom	

Channel Manager	Ant A	View/edit Channel ID, Scan, and Lock settings in antenna A.
	Ant B	View/edit Channel ID, Scan, and Lock settings in antenna B.
Locks	Change Access Code	Change Lock access code.
	Engage Lock	Choose to lock channel, video input, and/or front panel.
	TV Time Lock	Set specific time to Lock TV.
	Movie Ratings	Block various types of movies and video types based on motion picture ratings.
	TV Ratings	Block various types of movies and television programming based on a parental guide ratings.
	Canadian Ratings (ENG)	Block various types of movies and television programming based on the Canadian ratings system.
Timers	Canadian Ratings (FRN)	Block various types of movies and television programming based on the Canadian French ratings system.
	Set the Clock	Set Clock Settings.
	Set Sleep Timer	Set Sleep Timer intervals (30 min. intervals, 00:30-3:00).
	Set Day/Night Timer	Set Day/Night picture mode settings.
	Set Event Timer	Set viewing reservation for TV programs.
Setup	Set Auto Power Off	Set TV to turn off automatically when a video signal is not detected for 15 minutes.
	Menu Preference	Choose English, French, or Spanish text.
	Screen Saver	Set the Screen Saver.
	Set The Inputs	Label Video Inputs , VCR, DVD, etc.
	Set Black Side Panel	Set the gray side bars on/off when watching 4:3 signals in standard mode.
	Set Closed Captions	Feature to display dialogue/text.
	Set Monitor Out	Set Monitor Out source.
Set AV Control	Select to set RS232C feature.	

# VIDEO

## Video

Select VIDEO to adjust picture settings and improve picture quality. You can independently customize each of the Video Inputs to your preference to increase viewing performance and pleasure depending upon the video program being viewed. If RESET is selected, only the selected input will reset to initial conditions.

### Picture Mode

Use this function to choose from automatic picture settings to optimize your TV's performance.

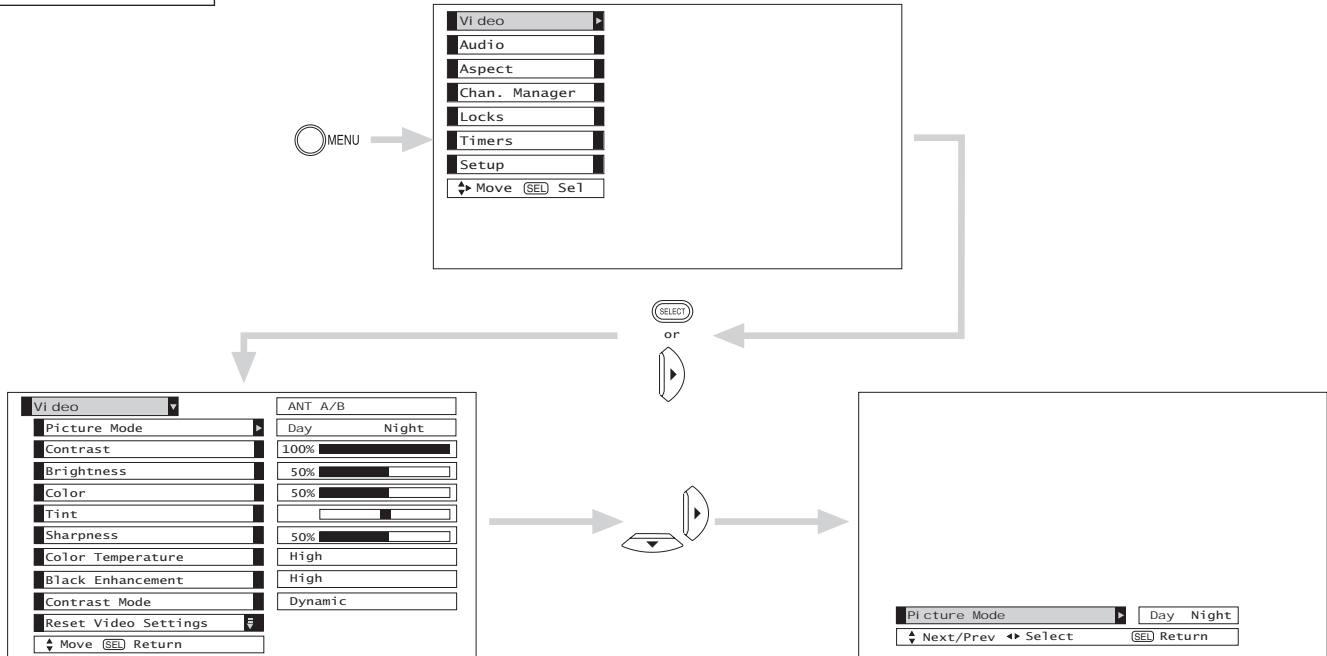

Use CURSOR button ◀ or ▶ to highlight and select Picture Mode settings.

Function	Day	Night	Reset
Contrast	100%	90%	Reset the video menu settings on current input automatically to Day Mode
Brightness	50%	50%	
Color	50%	30%	
Tint	50%	50%	
Sharpness	50%	30%	
Color Temperature	High	Standard	
Black Enhancement	High	Off	
Contrast Mode	Dynamic	Normal	
Color Management (Set User Colors)	Off	Off	
Auto Color	Off	Off	
Noise Reduction	Low	Low	
Auto Movie Mode (TV/Cinema Detection)	Off	Off	

Press EXIT to quit the menu or press SELECT to return to the previous menu.

Use the CURSOR button ▲ or ▼ to highlight the function to be adjusted.  
 Press the CURSOR button ◀ or ▶ to adjust the function. Press the SELECT button to select the function settings.  
 Press MENU to return to the main menu or select Picture Mode to return to the previous menu.  
 Press EXIT to quit the menu.

Contrast	Use this function to change the contrast between black and white levels in the picture.
Brightness	Use this function to adjust overall picture brightness.
Color	Use this function to adjust the level of color in the picture.
Tint	Use this function to adjust flesh tones so they appear natural.
Sharpness	Use this function to adjust the amount of fine detail in the picture.
Color Temperature	Set this to High for cooler color with more blue, set to Medium for more natural color, set to Standard for accurate color or set to Black/White for more reddish color.
Black Enhancement	Use this function to enhance the shadow detail in dark scenes using the settings off, low, middle and high.
Contrast Mode	Use this function to choose between 3 Contrast Mode settings. Set to Dynamic for darker images more in the level of Black, set to Normal for a balanced White to Black level, and set to Auto for automatic Contrast selection.

- NOTES:**
1. If CONTRAST is selected, you are adjusting CONTRAST. The additional menu items BRIGHTNESS, COLOR, TINT, and SHARPNESS can be selected and adjusted in the same manner.
  2. It may be necessary to adjust TINT to obtain optimum picture quality when using the COMPONENT VIDEO Y-P-B/R input jacks.
  3. ANT A and B share a Video setting. Also, each of the video inputs have their own independent settings.
  4. If CONTRAST is set to minimum level, the On-Screen Display (OSD) will be difficult to see.

# VIDEO

## Reset Video Settings

This function allows you to Reset the Video Menu Settings of the present input and return it to the Day VIDEO mode.

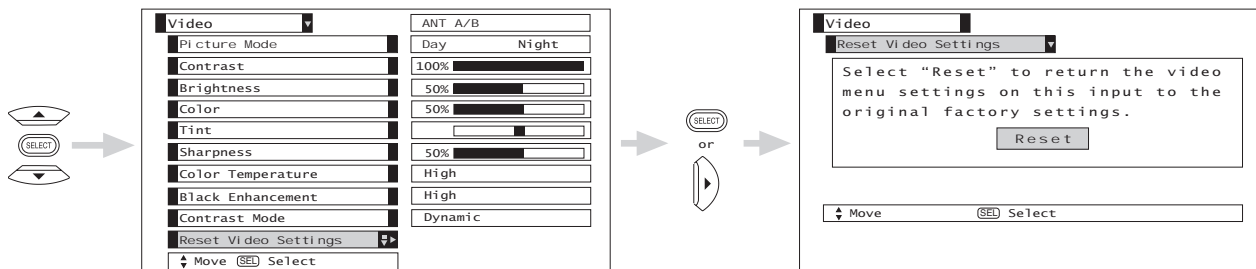

Use CURSOR button ▲ or ▼ to highlight functions.

Press the SELECT button to select Reset Video Settings.

Press EXIT to quit the menu or select RESET VIDEO SETTINGS to return to the previous menu.

You can customize each of the Video Inputs to your preference to increase viewing performance and pleasure, depending upon the video program being viewed. If RESET is selected, only the selected Input will reset to the initial conditions as explained above.

If RESET is selected in Video:1 Input, only Video:1 Input will return to factory conditions.

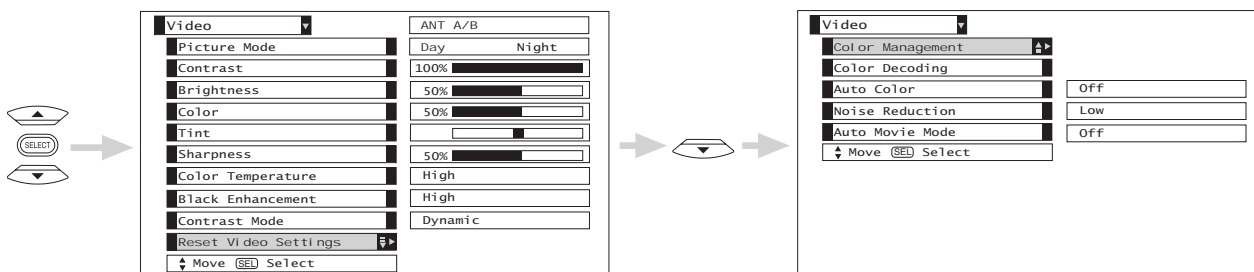

## Color Management

Use this function to adjust and balance the listed individual colors to make them either deeper or more pure depending on the user's preference. Adjust the GAIN settings to make the color brighter (+) or darker (-).

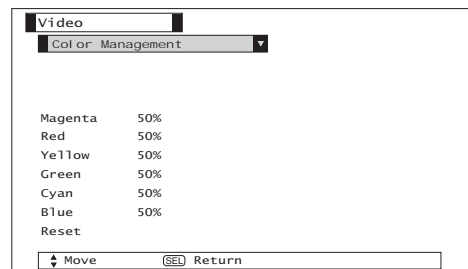
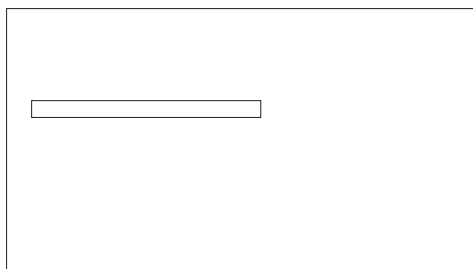

## Color Decoding

Use this function to adjust and balance the percentage of Red, Green and Blue according to the user's preference in each of the four color temperature settings. Use TINT to adjust flesh tones so they appear natural.

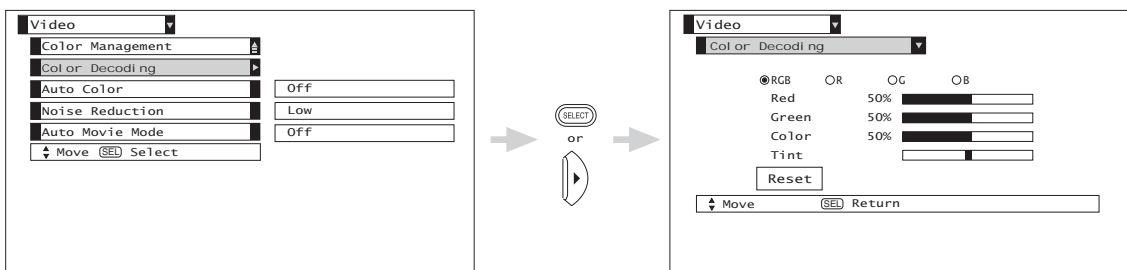

Use the CURSOR button ▲ or ▼ to highlight function.  
 Press down to select from 4 menu items.  
 Press the CURSOR buttons ◀, ▶, ▲ and ▼ to highlight and adjust Red, Green, Color and Tint.  
 Use the CURSOR button ▲ or ▼ to highlight and select "Reset" to return all settings to default.  
 Press EXIT to quit the menu or select COLOR DECODING to return to the previous menu.

**NOTE:** Color Decoding settings are independently stored in each of the 4 Color Temperature settings.

## Auto Color

The AUTO COLOR function automatically monitors and adjusts the color to maintain constant color levels even after a program or channel changes. It also maintains natural flesh tones while preserving fidelity of background colors.

**NOTES:**

1. When using Component, HDMI or DVI input, Auto Color will not be available (grayed out).
2. When using digital channels, Auto Color will not be available (grayed out).

## Noise Reduction

The NOISE REDUCTION function automatically reduces conspicuous noise in the picture without degrading picture quality. Set NOISE REDUCTION to OFF if the TV experiences picture blocking.

## Auto Movie Mode

The Auto Movie Mode function turns ON or OFF the 3:2 PULLDOWN DETECTION SPECIAL FEATURE. Theatrical movies are shot on film at 24 frames or still pictures per second, instead of 30 frames or 60 fields like video. When film is transferred to video for television viewing, the disparity between the two frame rates must be reconciled. This involves a process known as 3:2 pull-down.

When Auto Movie Mode is turned ON from the VIDEO menu, your Hitachi Projection Television will activate the circuitry for this special feature to improve video performance when watching film based sources.

**NOTES:**

1. When using Progressive Scan Component, HDMI or DVI input (Ex. 480p, 720p, 1080i), Auto Movie Mode will not be available (grayed out).
2. All Video settings are independent of each other based on it's input (ANT A/B, Input 1~5).



# AUDIO

## Audio

Select AUDIO to adjust the TV to your preference and to improve the sound quality.

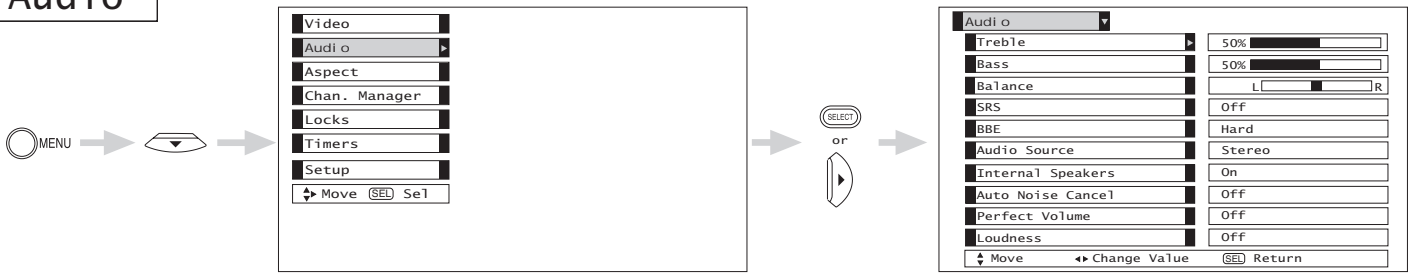

Use CURSOR button ▲ or ▼ to select menu item.  
 Use CURSOR button ◀ or ▶ to adjust the function.  
 Press EXIT to quit the menu or select AUDIO to return to the main menu.

**NOTE:** If TREBLE is selected you are adjusting treble. The additional menu items Bass and Balance can be selected and adjusted in the same manner.

Treble

This function controls the high frequency audio to all speakers.

Bass

This function controls the low frequency audio to all speakers.

Balance

This function will control the left to right balance of the LCD TV internal speakers.

SRS



Based on the principles of the human hearing system, SRS 3D technology delivers an exciting and realistic 3D Sound experience from just two external speakers or the two internal speakers found in your HITACHI Television. SRS will also enhance a complete multi-speaker surround sound system.

**NOTES:** \*SRS and the (●) symbol are registered trademarks of SRS Labs, Inc. SRS technology is incorporated under license from SRS Labs, Inc.

BBE

### BBE Technology

Sound reproduction quality enhancement system. The BBE technology produces sound that is natural and crisp from just two speakers or the two internal speakers found in your HITACHI television. If your HITACHI television is connected to an external audio system, BBE will also create an incredible crisp sound experience from two speakers. BBE brings to the listener's ear a more complete and accurate reproduction of the original performance. Each voice, speaking or singing, each instrument or sound effect is presented with its attendant harmonics or partials more clearly audible. The ear can then more easily recognize the unique tonal colors of each sound as though the sound was being produced live.

**NOTES:** Licensed by BBE Sound, Inc. under USP5510752 and 5736897. BBE and BBE symbol are registered trademarks of BBE Sound, Inc. Manufactured under license from BBE Sound, Inc.

## Audio Source

Multi-Channel Television Sound will allow you to select STEREO (a stereo broadcast), MONO (monaural sound) used when receiving a weak stereo broadcast or 2nd Audio Prog (SAP) which may be a secondary language, weather report, etc.

The sources received will be displayed at the top right edge of the TV. The source you select will be displayed above the sources received. See example below for each selection when both stereo and second audio are received (monaural is always received).

### STEREO SELECTED

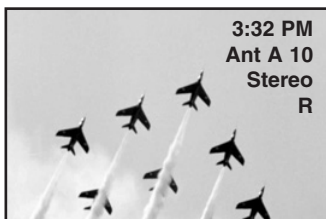

### SAP SELECTED

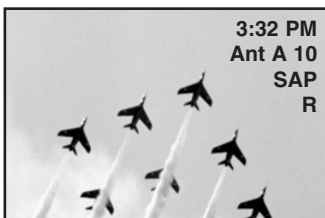

### MONO SELECTED

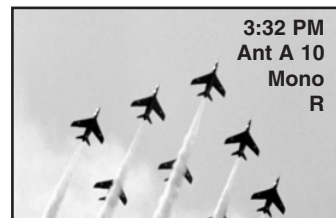

## Internal Speakers

This function is useful when setting up the external speakers.

ON - Select this feature if using the internal speakers only.

TV as Center - Select this feature when setting up external speakers from a separate stereo system.

The TV's speakers will work as the center speaker.

OFF - Select this feature if you prefer to use only speakers from a separate stereo system.

## Auto Noise Cancel

This function eliminates the noise between stations. If a channel is tuned and is noisy, this function will automatically eliminate the audio for that channel.

## Perfect Volume

This function will automatically adjust volume so each channel and input has the same average volume level.

## Loudness

This function turns loudness ON or OFF. It will improve the quality of both low and high frequency sounds when listening at low volume levels.

# ASPECT

## Aspect

Use this function to select the Picture Format Aspect Ratio.

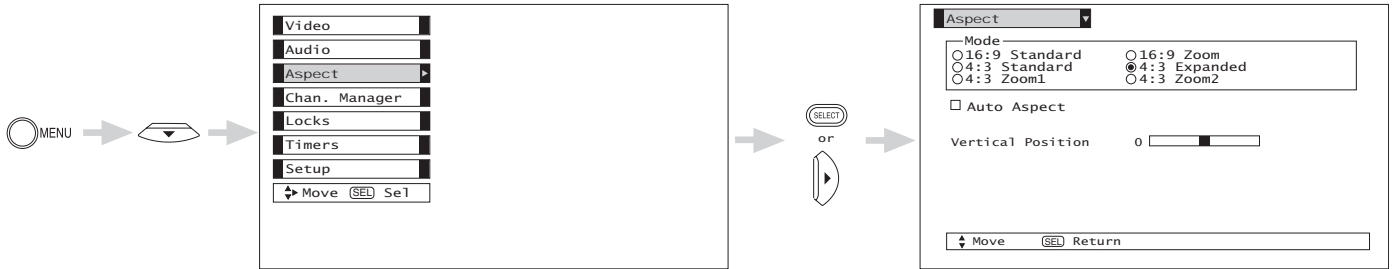

### Mode

This function manually selects the Aspect Mode from six (6) choices.

Use the CURSOR buttons ▲, ▼, ◀ and ▶ to select the menu item.  
Press the SELECT button to select.

### Auto Aspect

Automatically adjust the Aspect Ratio depending on the input signal to fill the screen.

Use CURSOR button ▲ or ▼ to highlight the Auto Aspect box.  
Press the SELECT button to select. A "✓" in the box indicates that the feature is ON.

- NOTES:**
1. The Auto Aspect function is recommended on an input signal with VIDEO ID.
  2. The Auto Aspect function is best used on composite video, S-Video, 480i and 480p component signals.
  3. See page 22 for Aspect Mode availability.

### Vertical Position

This function allows you to adjust the vertical position of the picture when aspect style is either 4:3 EXPANDED/ZOOM1/ZOOM2 or 16:9 ZOOM. For example, it will be useful for centering the picture area at both the top and bottom of the picture with 480i/480P signal. Adjustable range is -10 (video center is toward bottom of screen) to +10 (video center is toward top of screen).

Use the CURSOR button ▲ or ▼ to select menu item.  
Use the CURSOR button ◀ or ▶ to adjust the function.  
Press EXIT to quit the menu or select ASPECT to return to the main menu.

**NOTE:** Vertical Position will not be available in 4:3 Standard and 16:9 Standard modes.

## Chan. Manager

Select ANTENNA if you are using an indoor or outdoor antenna. Select Cable if you have cable TV.

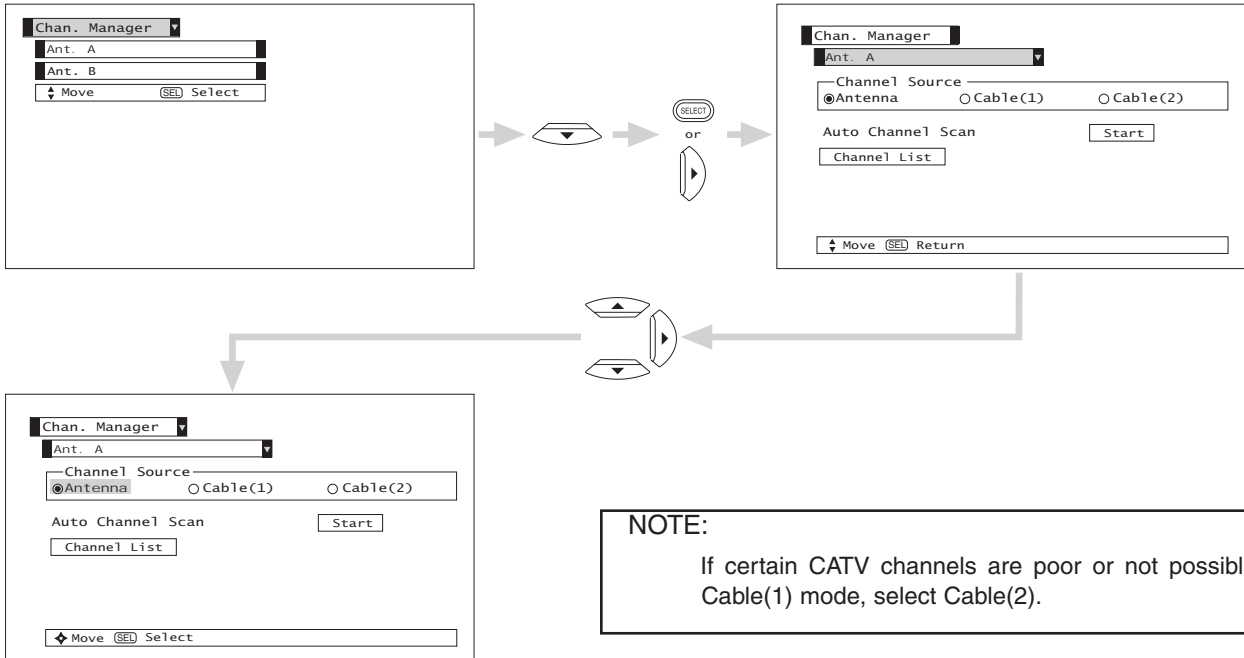

### NOTE:

If certain CATV channels are poor or not possible in Cable(1) mode, select Cable(2).

Use the CURSOR button ◀ or ▶ to highlight the correct Channel Source.  
 Press the SELECT button to select highlighted source.  
 Press EXIT to quit the menu or select CHAN. MANAGER to return to the previous menu.

# CHANNEL MANAGER

## Auto Channel Scan

This feature will automatically store active TV channels in Auto Channel Memory. This will allow you to skip unused channels when using CHANNEL UP (▲) or DOWN (▼).

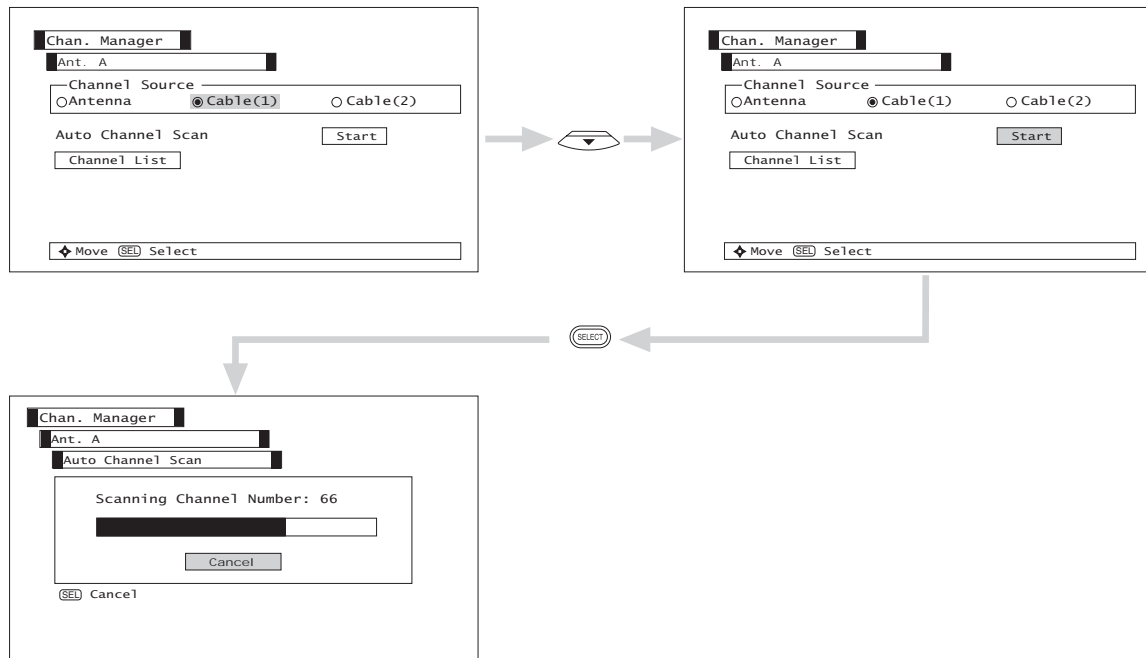

If the EXIT button is pressed while AUTO CHANNEL SCAN function is engaged, programming will stop. If two antennas are connected, switch antenna inputs and repeat AUTO CHANNEL SCAN for the second antenna input.

Remember to select the correct ANTENNA/CABLE mode before using AUTO CHANNEL SCAN. See CHANNEL MANAGER - SCAN to add or to bypass additional channels.

## Channel List

This function allows you to review which channels are labeled (CH ID), which have been added to Channel Memory (SCAN), and which are protected by LOCK.

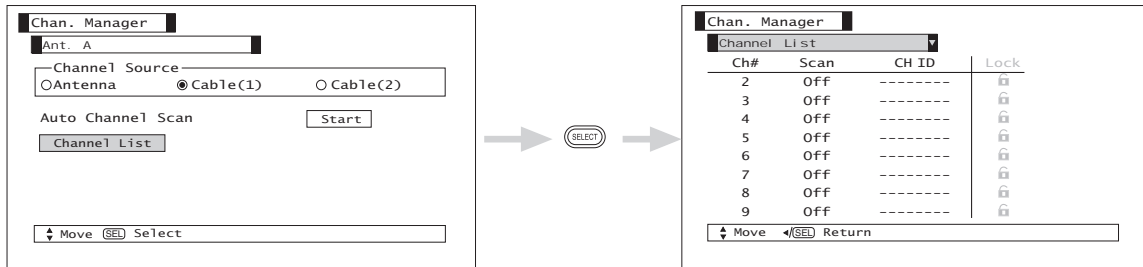

Use the CURSOR button ▲ or ▼ to review more channels.  
Press EXIT to quit the menu or select CHAN. MANAGER to return to the previous menu.

## Scan

Use this feature after Auto Channel Scan is completed to add (On) or skip (Off) additional channels to the remote control channel ▲ or ▼ buttons.

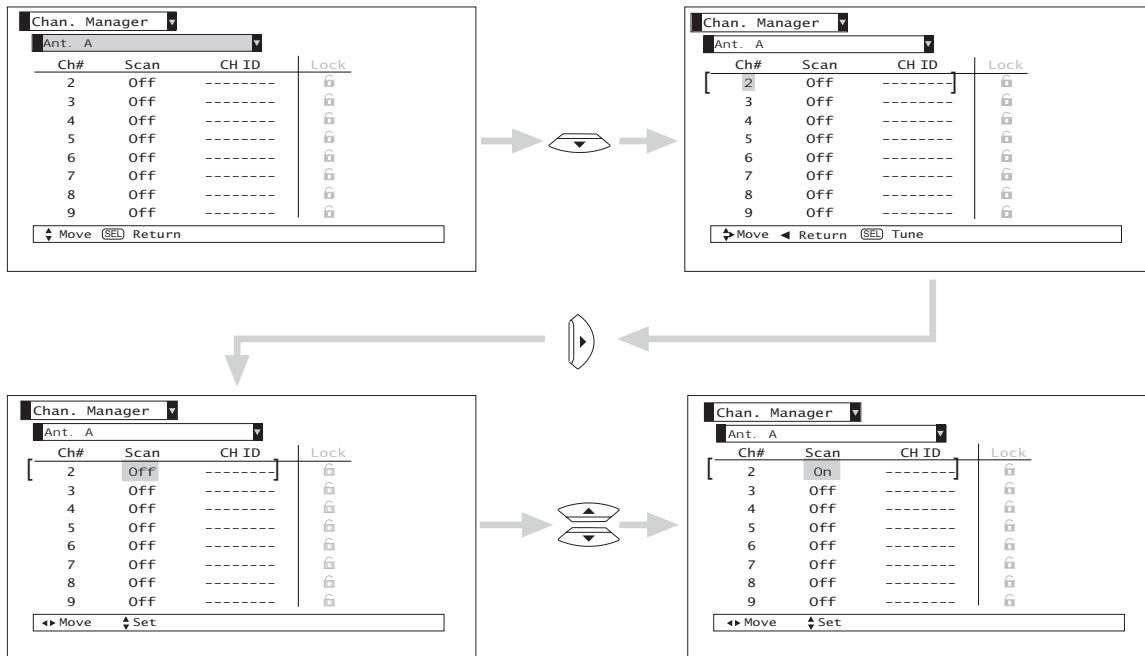

ON-SCREEN DISPLAY

To add (Scan-On) or skip (Scan-Off) additional channels while in Channel Manager, use the CURSOR button ▲ or ▼ to highlight the channel number. Once the desired channel is highlighted, press the CURSOR button ► to move to the scan column, then press CURSOR button ▲ or ▼ to select ON or OFF.

**NOTE:** Lock feature cannot be selected or set in Channel List.

# CHANNEL MANAGER

## Channel ID

This section contains advanced features which will make TV viewing easier and more enjoyable. Use this feature to give up to 20 channels a name when ANTENNA signal source is selected and up to 60 channels a name when Cable 1 or 2 signal source is selected.

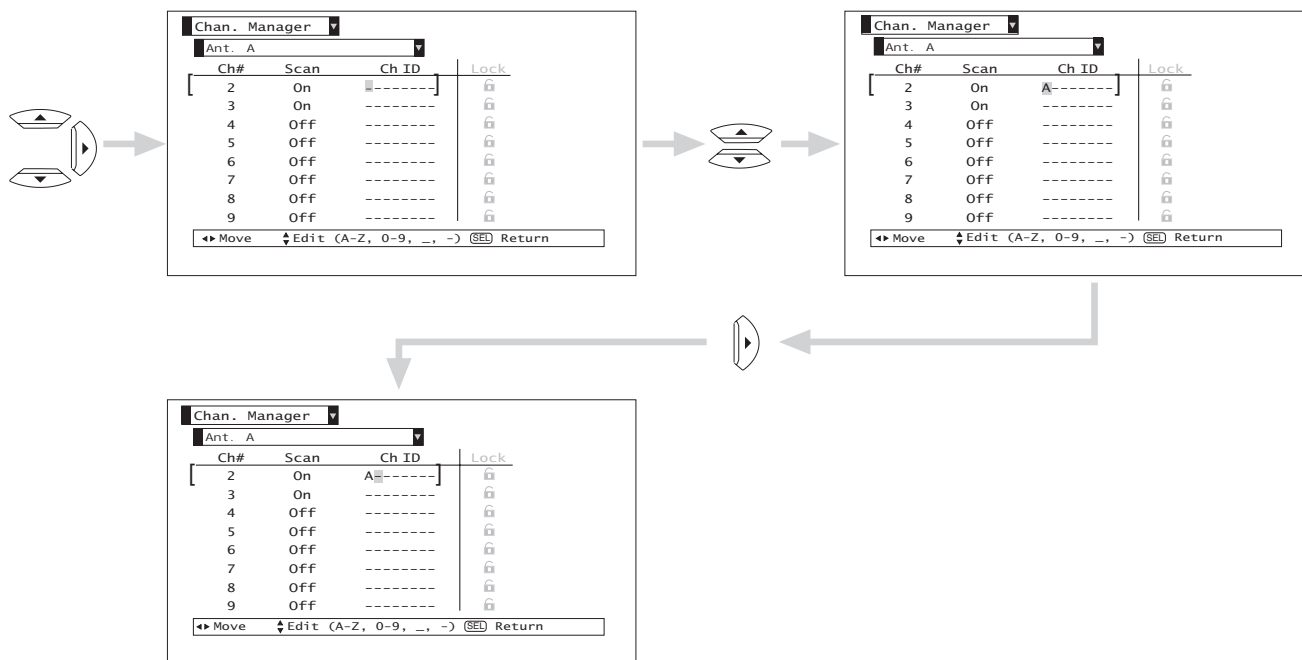

Use the CURSOR button ▲ or ▼ to select the chosen number or letter.

Use the CURSOR button ◀ or ▶ to move from one space to the next space in the Channel ID.

- NOTES:**
1. If ANT A and ANT B are in the same ANTENNA/CABLE mode, the CHANNEL ID for both antenna inputs will be the same.
  2. CHANNEL ID will not be displayed when PIP is ON.

## Locks

This function will block out the picture and sound of the selected channel or video input. It can also be used to keep the TV from being viewed for a scheduled time period that you set.

The code to enter the Locks feature is a four digit access code number. The factory preset code is 0000. Use the number buttons to enter the access code.

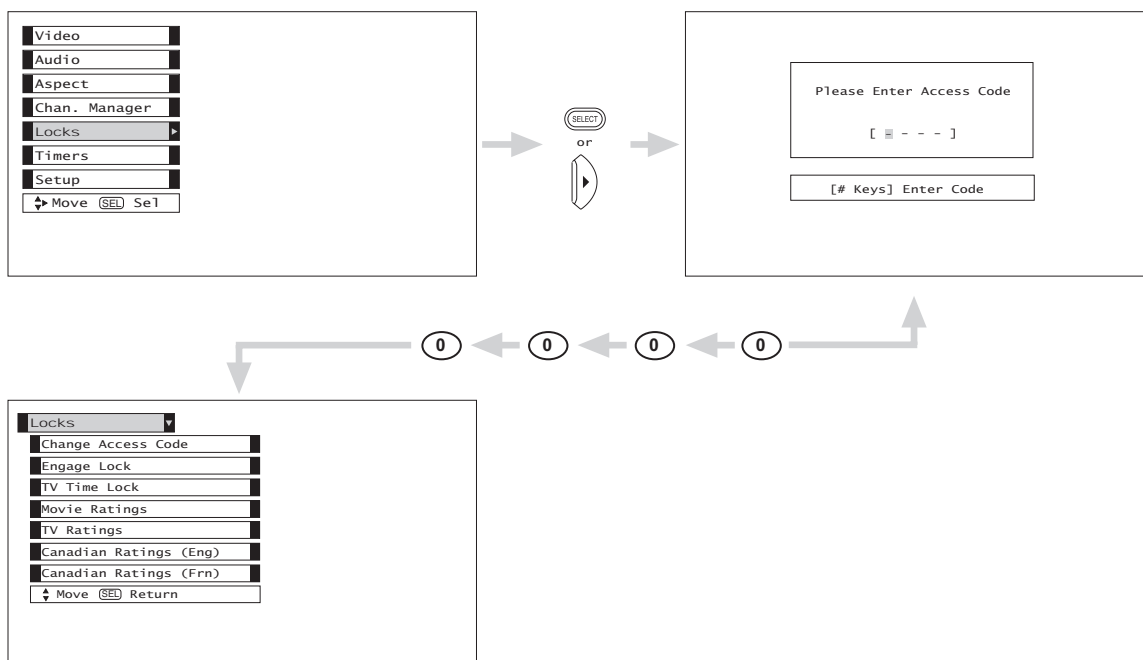

Use the CURSOR buttons ▲ or ▼ to highlight function and then press the SELECT button. To change the access code number, select Change Access Code. Enter a new four digit number.

Select CHANGE ACCESS CODE to change the factory preset code (0000) to your preference.

When ENGAGE LOCK is selected, SET CHANNEL LOCK, SET INPUT LOCK, and SET FRONT PANEL LOCK can be set individually.

When SET CHANNEL LOCK is turned on, the picture and sound for the chosen channel will be blocked out.

When SET INPUT LOCK is turned on, the picture and sound for all video inputs and the picture and sound for channels 3, 4 will be blocked out.

When FRONT PANEL LOCK is turned on, all buttons on the Front Panel will be deactivated, except the Power button.

When TV TIME LOCK is turned on (☑ TIME LOCK), then you can set the BEGIN and END times (CURSOR button ▲, ▼, ◀ and ▶). The TV cannot be viewed during that time period (Set clock first). Use CURSOR buttons ▲ or ▼ to highlight ONCE (TV will time out one time only), DAILY (TV will time out every day), WEEKLY (TV will time out one time a week).

When MOVIE RATINGS is selected, you can block various types of movies and video tapes based on motion picture ratings (see page 49). Picture-in-Picture will also be blocked automatically.

When TV RATINGS is selected, various types of television programming based on a parental guide ratings will be blocked (see page 50). Picture-in-Picture will also be blocked automatically.

Use CANADIAN RATINGS to block various types of movies and television programs based on the two rating systems used in Canada that you feel may be inappropriate due to its content (see pages 51-52).

If you forget your access code, use the factory code 7777 to erase your key number. This will reset the access code number back to the factory preset 0000.

Press EXIT to quit the menu or select LOCKS to return to the previous menu.

- NOTE:**
1. When using TV TIME LOCK make sure the clock is set (see page 53).
  2. Text appears on the screen to indicate that TV TIME LOCK is activated.
  3. If MOVIE/TV Ratings Lock function settings are ON, SURF will be deactivated.



# LOCKS

## Movie Ratings

Use MOVIE RATINGS to prevent viewing of any movie that you feel may be inappropriate due to its content.

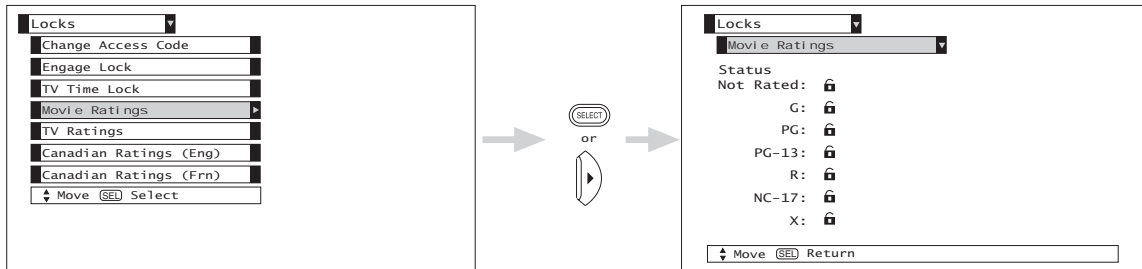

Use the CURSOR button ▲ or ▼ to select the MOVIE RATING category that you want to block. Press SELECT to block the MOVIE RATING that you have selected. Once rating is selected, for example PG-13, all movies rated PG-13 and higher (R, NC-17, and X) will be blocked. Press EXIT to quit the menu or select MOVIE RATINGS to return to the previous menu.

## Motion Picture Ratings Table

NOT RATED (NR)	<b>Contains no rating. Not Rated (NR) and Not Applicable (NA) programs.</b> Movie has not been rated or ratings do not apply.
G	<b>General audiences.</b> All ages admitted.
PG	<b>Parental guidance suggested.</b> Some material may not be suitable for children.
PG-13	<b>Parents strongly cautioned.</b> Some material may be inappropriate for children under 13.
R	<b>Restricted.</b> Under 17 requires accompanying parent or adult guardian.
NC-17	<b>No one 17 and under admitted.</b>
X	<b>Adults only</b>

**NOTES:**

1. A movie rating is dependent upon the movie that is viewed. If the movie does not carry a rating, the TV will not block it.
2. Blocking "NOT RATED (NR)" programs may block emergency programming, sports, news, public service announcements, religious programs and weather.

## TV Ratings

Use TV RATINGS to prevent the viewing of any TV program that you feel may be inappropriate due to its content.

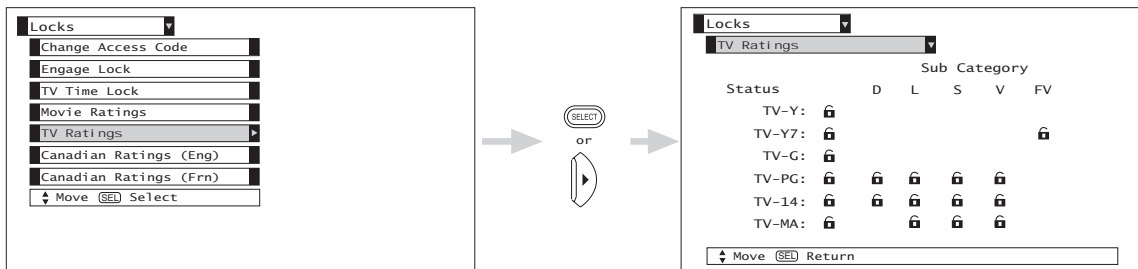

Use the CURSOR buttons ▲, ▼, ◀ and ▶ to highlight the category that you want to block. Press select to block the TV RATINGS that you have selected. Press EXIT to quit the menu or select TV RATINGS to return to the previous menu.

### TV Parental Guide Ratings Table

TV-Y	<b>All children.</b> The themes and elements in this program are specifically designed for a very young audience, including children from ages 2-6.
TV-Y7	<b>Directed to older children.</b> Themes and elements in this program may include mild physical or comedic violence, or may frighten children under the age of 7.
TV-G	<b>General audience.</b> It contains little or no violence, no strong language, and little or no sexual dialogue or situations.
TV-PG	<b>Parental guidance suggested.</b> The program may contain infrequent coarse language, limited violence, some suggestive sexual dialogue and situations.
TV-14	<b>Parents strongly cautioned.</b> This program may contain sophisticated themes, intense sexual situation, more intense violence and intensely suggestive dialogue.
TV-MA	<b>Mature audiences only.</b> This program may contain mature themes, indecent language, graphic violence, and explicit sexual content.
FV	<b>Fantasy Violence</b>
V	<b>Violence</b>
S	<b>Sexual Situation</b>
L	<b>Adult Language</b>
D	<b>Sexually Suggestive Dialogue.</b>

#### NOTES:

1. If you Block TV-14D, you will still permit TV MA programs; If you block TV-14V, you will automatically block TV-MAV programs, but you will still permit TV-MALS programs. This means that the TV will block violence in TV-14 and higher (TV-MA), but not language and sex.
2. TV program ratings are dependent on the broadcaster. If the program is not rated, the TV will not block it.

# LOCKS

Canadian Ratings (Eng)

Use Canadian Ratings (ENG) to block any type of movie and television program in Canada that you feel might be inappropriate in its content.

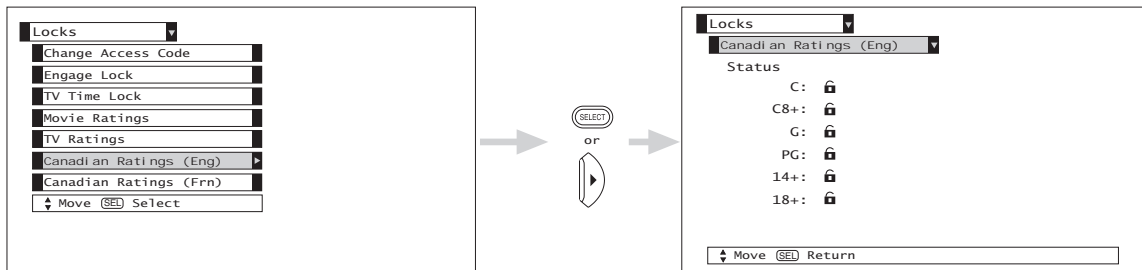

Use the CURSOR button ▲ or ▼ to select the CANADIAN RATINGS (ENG) category that you want to block. Press SELECT to set the CANADIAN RATINGS (ENG) that you have selected. Once rating is selected, for example C8+, all movies and television programs rated C8+ and higher (G, PG, 14+ and 18+) will be blocked automatically. Press EXIT to quit the menu or select CANADIAN RATINGS (ENG) to return to the previous menu.

## Canadian Ratings English Table

C	<b>Programming intended for children under age 8</b> - Violence Guidelines; Careful attention is paid to themes, which could threaten children's sense of security and well-being. There will be no realistic scenes of violence. Depictions of aggressive behaviour will be infrequent and limited to portrayals that are clearly imaginary, comedic or unrealistic in nature. Other Content Guidelines: There will be no offensive language, nudity or sexual content.
C8+	<b>Programming generally considered acceptable for children 8 years and over to watch on their own</b> - Violence Guidelines: Violence will not be portrayed as the preferred, acceptable, or only way to resolve conflict; or encourage children to imitate dangerous acts which they may see on television. Any realistic depictions of violence will be infrequent, discreet, of low intensity and will show the consequences of the acts. Other Content Guidelines: There will be no profanity, nudity or sexual content.
G	<b>General Audience</b> - Violence Guidelines: Will contain very little violence, either physical or verbal or emotional. Will be sensitive to themes which could frighten a younger child, will not depict realistic scenes of violence which minimize or gloss over the effects of violent acts. Other Content Guidelines: There may be some inoffensive slang, no profanity and no nudity.
PG	<b>Parental Guidance</b> - Programming intended for a general audience but which may not be suitable for younger children. Parents may consider some content inappropriate for unsupervised viewing by children ages 8-13. Violence Guidelines: Depictions of conflict and/or aggression will be limited and moderate; may include physical, fantasy, or supernatural violence. Other Content Guidelines: May contain infrequent mild profanity, or mildly suggestive language. Could also contain brief scenes of nudity.
14+	<b>Programming contains themes or content which may not be suitable for viewers under the age of 14</b> - Parents are strongly cautioned to exercise discretion in permitting viewing by pre-teens and early teens. Violence Guidelines: May contain intense scenes of violence. Could deal with mature themes and societal issues in a realistic fashion. Other Content Guidelines: May contain scenes of nudity and/or sexual activity. There could be frequent use of profanity.
18+	<b>Adult</b> - Violence Guidelines: May contain violence integral to the development of the plot, character or theme, intended for adult audiences. Other Content Guidelines: May contain graphic language and explicit portrayals of nudity and/or sex.

## Canadian Ratings (Frn)

Use CANADIAN RATINGS (FRN) to block Canadian French programs according to various program ratings that you feel might be inappropriate in its content.

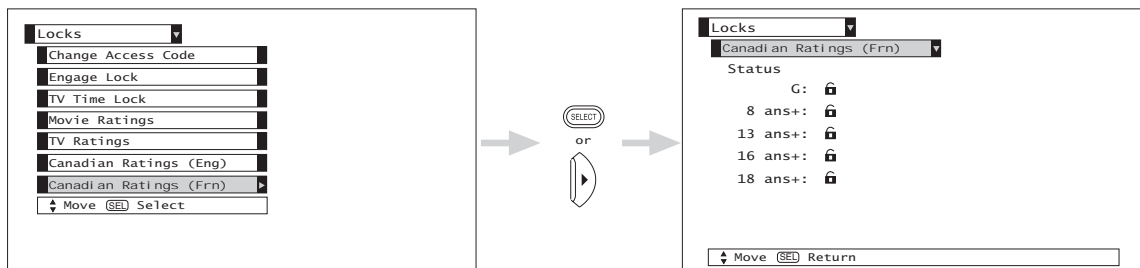

Use the CURSOR buttons ▲ or ▼ to highlight the category that you want to block.

Press SELECT to set the CANADIAN RATINGS (FRN) that you have selected.

Once rating is selected, for example 8 ans+, all movies and television programs rated 8 ans+ and higher will be automatically blocked.

Press EXIT to quit the menu or select CANADIAN RATINGS (FRN) to return to the previous menu.

## Canadian Ratings French Table

G	<b>General</b> - Programming intended for audiences of all ages. Contains no violence, or the violence content is minimal or is depicted appropriately with humor or caricature or in an unrealistic manner.
8 ans +	<b>8 + General - Not recommended for young children</b> - Programming intended for a broad audience but contains light or occasional violence that could disturb young children. Viewing with an adult is therefore recommended for young children (under the age of 8) who cannot differentiate between real and imaginary portrayals.
13 ans +	<b>Programming may not be suitable for children under the age of 13</b> - Contains either a few violent scenes or one or more sufficiently violent scenes to affect them. Viewing with an adult is therefore strongly recommended for children under 13.
16 ans +	<b>Programming is not suitable for children under the age of 16</b> - Contains frequent scenes of violence or intense violence.
18 ans +	<b>Programming restricted to adults</b> - Contains constant violence or scenes of extreme violence.

# TIMERS

## Timers

Select Timers to set your Clock, Sleep Timer, Event Timer, Auto Power Off and Day/Night Timer Recordings.

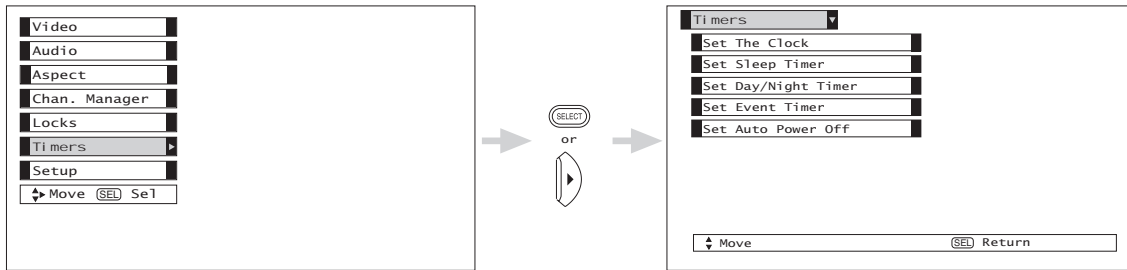

## Set The Clock

The Clock must be adjusted before you can use the "Set Event Timer" or Day/Night Timer" feature.

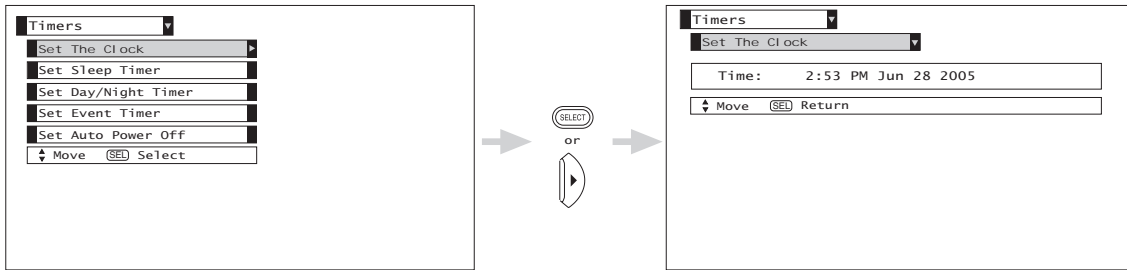

Use the CURSOR buttons ▲, ▼, ◀ and ▶ to highlight the current time (hour and minute), AM or PM, Month, Day, and Year.  
Use the CURSOR button ▲ or ▼ to adjust settings.  
Press the SELECT button to set the Time and Date.  
Press EXIT to quit the menu or select SET THE CLOCK to return to the previous menu.

## Set Sleep Timer

Select this feature to set your Sleep Timer from 30 minutes to 3 hours (30 minute increments).

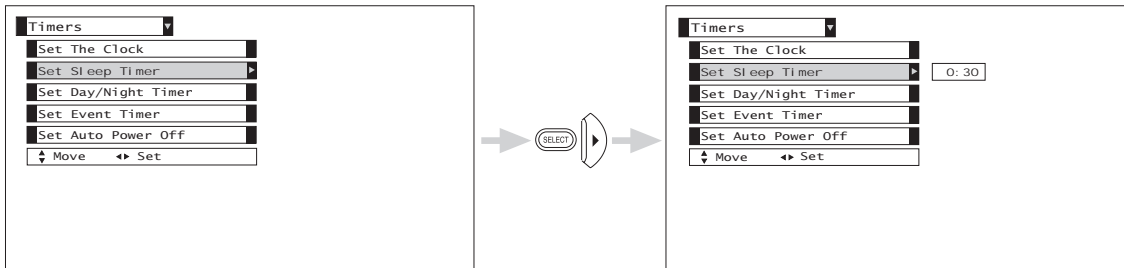

Press the CURSOR button ► repeatedly to set your Timer from 0:00, 0:30, 1:00, 1:30, 2:00, 2:30 and 3:00.

## Set Day/Night Timer

Select this feature to activate and set your TV's Day/Night Picture Mode automatically.

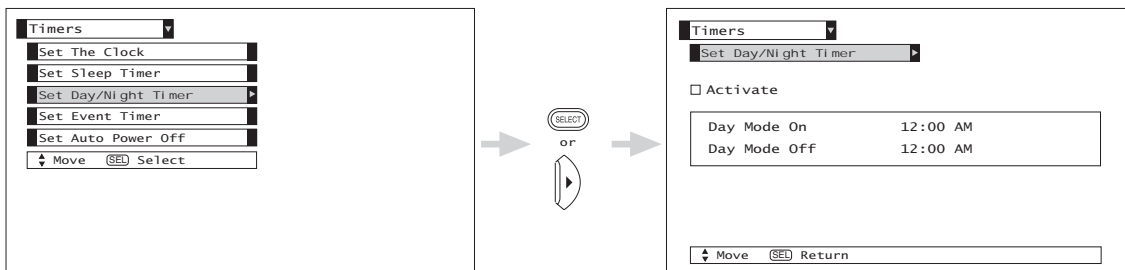

Use the CURSOR button ▲ or ▼ and the SELECT button to activate the Day/Night Timer.

Use the CURSOR buttons ▲, ▼, ◀ and ▶ to select Day Mode On and to set its timer.

Use the CURSOR buttons ▲, ▼, ◀ and ▶ to select Day Mode Off and to set its timer.

# TIMERS

## Set Event Timer

This function will automatically operate the Projection TV viewing reservation of a program. If the clock is not set, you can not use this function and the screen below will appear. The message on the screen will disappear after 3 seconds, then the screen automatically goes to the clock setup mode (see page 53).

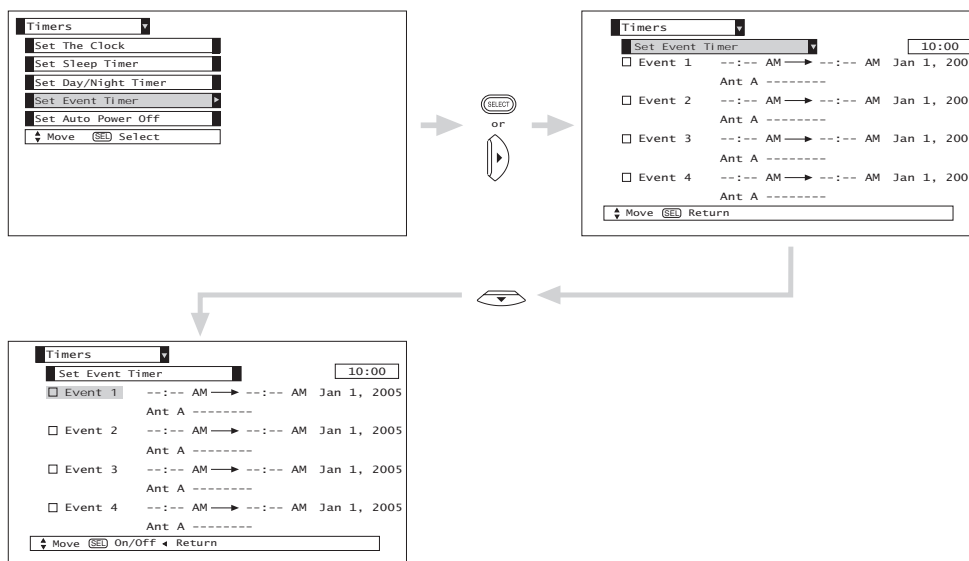
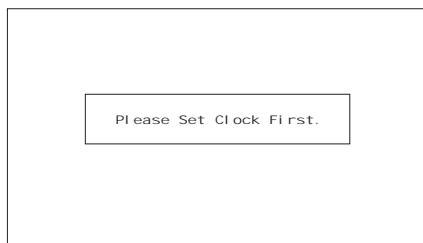

Use CURSOR button ▲ or ▼ to highlight Event 1, Event 2, Event 3, Event 4 and then press the SELECT button to select.

Use CURSOR buttons ►, ▲ and ▼ to highlight and select START TIME Hour/Minute.

Use CURSOR buttons ►, ▲ and ▼ to highlight and select START TIME AM/PM.

Use CURSOR buttons ►, ▲ and ▼ to highlight and select FINISH TIME Hour/Minute.

Use CURSOR buttons ►, ▲ and ▼ to highlight and select FINISH TIME AM/PM.

Use CURSOR button ► to highlight the MONTH.

Use CURSOR button ▲ to select a MONTH or CURSOR button ▼ to select Daily, Weekly - Sunday to Monday. Use CURSOR button ◀ to return to AM/PM.

Use CURSOR buttons ►, ▲ and ▼ to highlight and select the DAY of the MONTH.

Use CURSOR buttons ►, ▲ and ▼ to highlight and select the YEAR.

Use CURSOR buttons ►, ▲ and ▼ to highlight and select Ant A or Ant B.

Use CURSOR buttons ►, ▲ and ▼ or NUMBER buttons to set the channel the TV will tune into.

A "✓" in the box means it is enabled.

- NOTE:**
1. When the INFO button is pressed, the Event Timer Icon will only display the current date ON/OFF timer.
  2. The Off Timer will only activate if the TV was turned on by the On Timer and no channel selection was made after this time. If you change the channel after the On Timer has been activated, the Off Timer will deactivate.
  3. If no remote control button is pressed after viewing reservation is activated, the TV will automatically turn off after three hours. Therefore, do not Set Event Timer for more than three hours if you do not plan to control your television with the remote control.



**CAUTION:** Do not use your TV as a deterrent when away from home by using the On and Off Timers. For safety, the TV should be turned off when you are away from home.

This function will turn off the TV automatically when a video signal is not detected for 15 minutes.

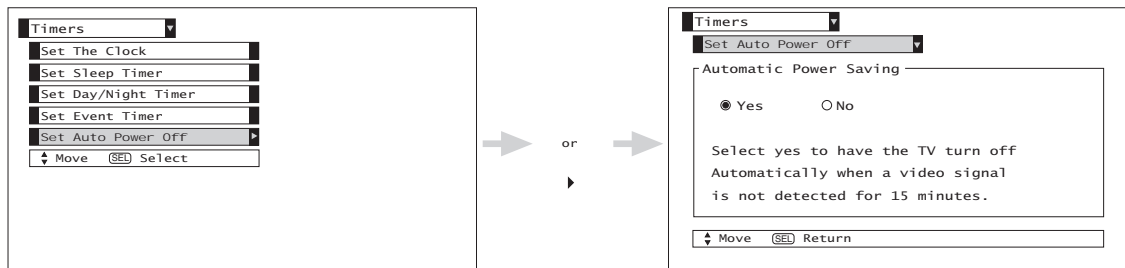



# SETUP

## Setup

Select SETUP when setting your TV up for the first time. Use the CURSOR buttons ▲ or ▼ on the remote to highlight the function desired.

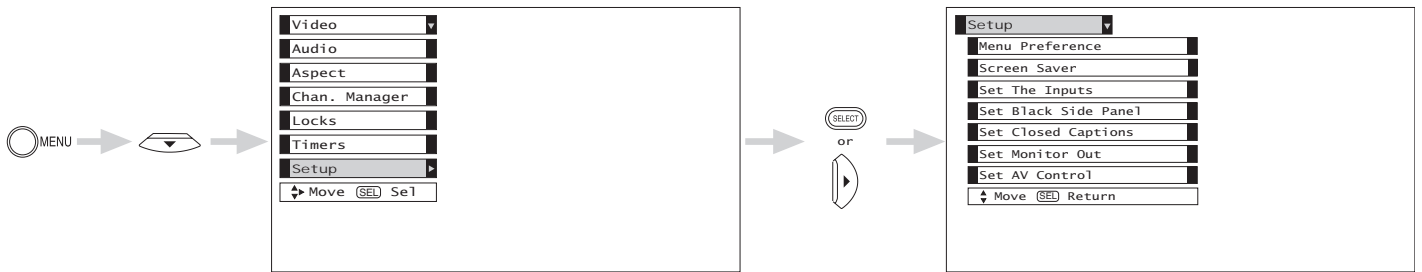

Use the CURSOR buttons ▲ and ▼ to highlight the sub-menu of your choice. Press the SELECT button or the CURSOR button ► to select.

## Menu Preference

This feature will allow you to select any one of three different languages for all on-screen displays.

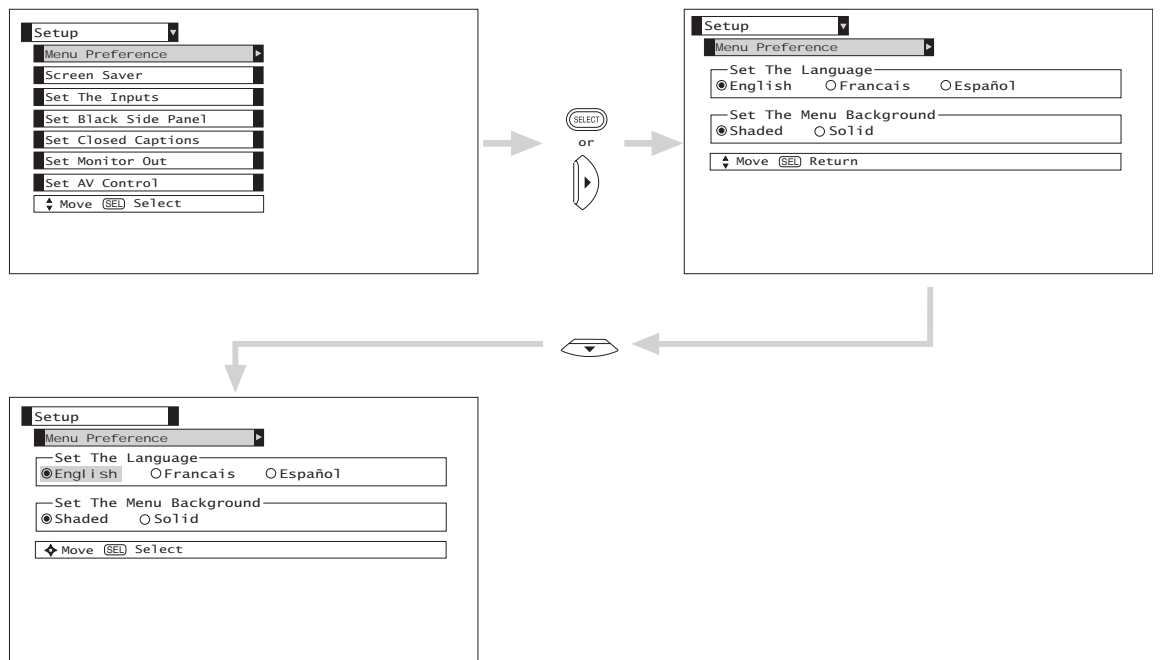

Use the CURSOR button ◀ or ▶ to highlight the language of your choice. Press SELECT to select the highlighted language. Press EXIT to quit menu or select MENU PREFERENCE to return to previous menu.

## Set The Menu Background

This function allows you to choose from two menu backgrounds.

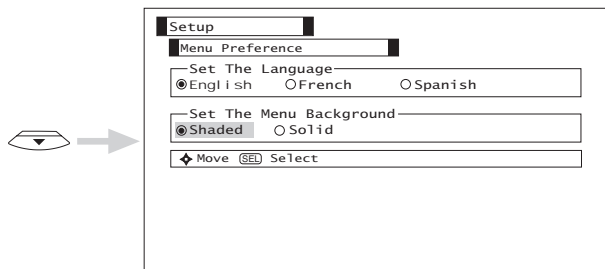

Use CURSOR button ◀ or ▶ to highlight Set The Menu Background (shaded or solid), and press the SELECT button to select setting.

Press EXIT to quit the menu or select MENU PREFERENCE to return to the previous menu.

Select Solid for a black background (no picture can be seen behind menu screen), or select Shaded for a light background.

## Screen Saver

Continuous on-screen displays such as video games, stock market quotations, computer generated graphics, and other fixed (non-moving) patterns can cause “temporary image retention” to the LCD Rear PTV. Use the SCREEN SAVER feature to avoid any temporary image retention. Moving picture will clear up any temporary image retention.

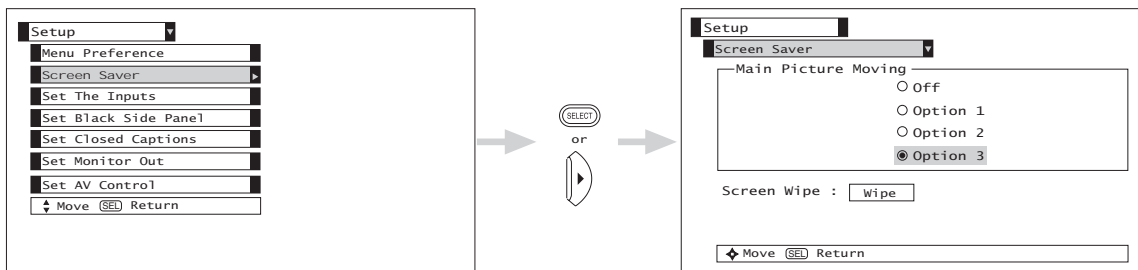

Use CURSOR button ▲ or ▼ to highlight Screen Saver's Main Picture Moving options.

Press the SELECT button to select and EXIT to quit.

### Option 1

The whole picture will shift every 20 minutes by two pixels.

### Option 2

The whole picture will shift every 40 minutes by two pixels.

### Option 3

The whole picture will shift every 60 minutes by two pixels.

### Screen Wipe

If temporary image retention occurs, use Screen Wipe (White Field Signal) for at least 10 minutes to refresh any temporary image retention that may have occurred.

### Screen Saver Picture's Movement

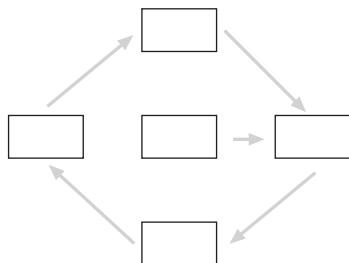

# SETUP

## Set The Inputs

Use this feature to give a name to any of the five video inputs.

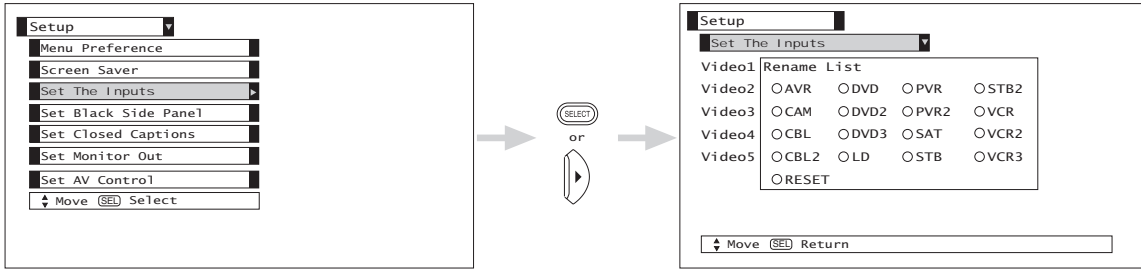

Use the CURSOR buttons to highlight the name of the video inputs.  
 Press the SELECT button to select desired input name.  
 Select Reset to set video names to original factory preset condition.

## Video 2 Auto Link

Use this function to automatically turn the TV on and tune to Video2 when it detects a video signal to input 2.

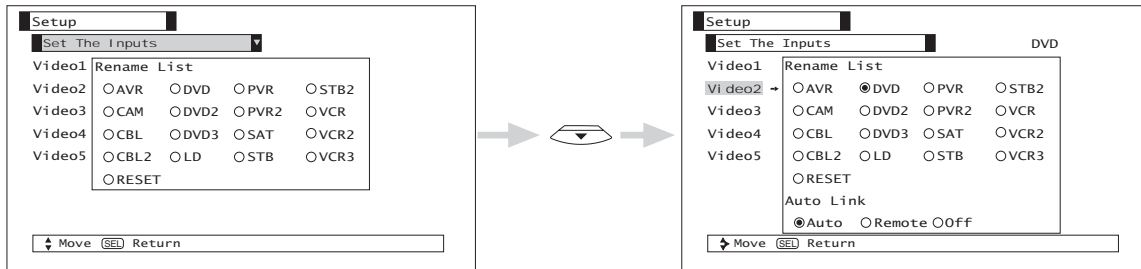

Use the CURSOR buttons, then press the SELECT button to change Auto Link setting.

When Auto is selected, the TV will turn on and tune to Video2 automatically, when the Video2 input device is turned on. This is convenient when you want to watch a movie with your VCR, laserdisc player, or DVD player.

When Remote is selected, the TV will turn on and switch to Video2 automatically when the Video2 input device is turned on and the VCR, laserdisc, or DVD play button on your remote control is pressed.

This is convenient when you want to record a movie with your VCR and watch it later.

Select Off to disable this function.

Press EXIT to quit the menu or select SET THE INPUTS to return to the previous menu.

- NOTES:**
- Once the TV has been turned on using the Auto Link feature, it must be reset before Auto Link is used again. To do this, turn your VCR, laserdisc, or DVD player OFF. This feature is now reset and will turn on your TV as described above.
  - When using Remote mode, any remote control button will substitute for your video input device play button. However, intended operation is for use with your VCR, laserdisc, or DVD play button.
  - If no remote control button is pressed after the TV is turned on by Auto Link, the TV will automatically turn off after three hours.

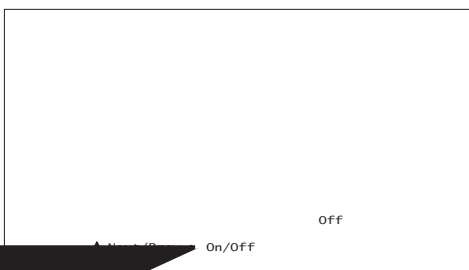

Use the CURSOR buttons to set to ON or OFF.



## Set Closed Caption

Closed Captions are the dialogue, narration, and/or sound effects of a television program or home video which are displayed on the TV screen. Your local TV program guide denotes these programs as **CC** or .

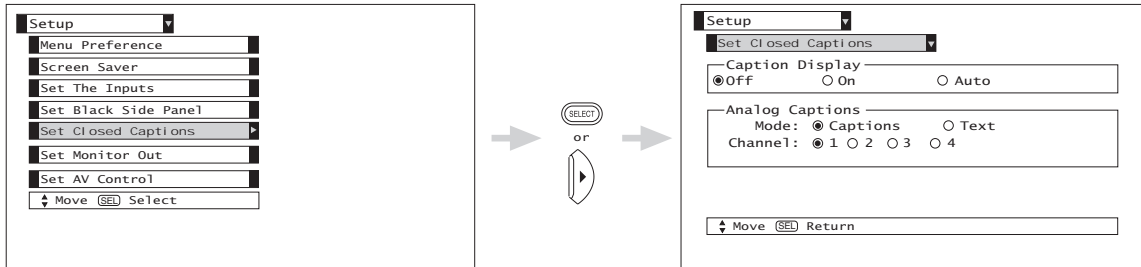

**Caption Display:** **On/Off** will turn the **CC** display on or off.

**Auto** will turn the **CC** display on when Mute/Soft Mute is on.

**Caption Mode:** **Captions** is for the program you are viewing.

**Text** is for additional information such as news reports or a TV program guide. This information covers the entire screen and viewing the TV program is not possible. Text may not be available with every **CC** program.

- CHANNEL:**
- 1 is used for the primary language (usually English).
  - 2 is sometimes used for a second language (may vary by region).
  - 3 is sometimes used for a third language (may vary by region).
  - 4 is sometimes used for a fourth language (may vary by region).

Use the CURSOR buttons ▲, ▼, ◀ and ▶ to highlight the function to change then press the SELECT button to select the function. Press EXIT to quit the menu or select SET CLOSED CAPTION to return to the previous menu.

- NOTES:**
1. CAPTION DISPLAY will not work when viewing a 480p, 720p, or 1080i input via the COMPONENT: Y-P<sub>B</sub>P<sub>R</sub> inputs.
  2. When PIP Surf is on, Closed Caption will not work.

# SETUP

## Set Monitor Out

This feature will select the source of the Monitor Output.

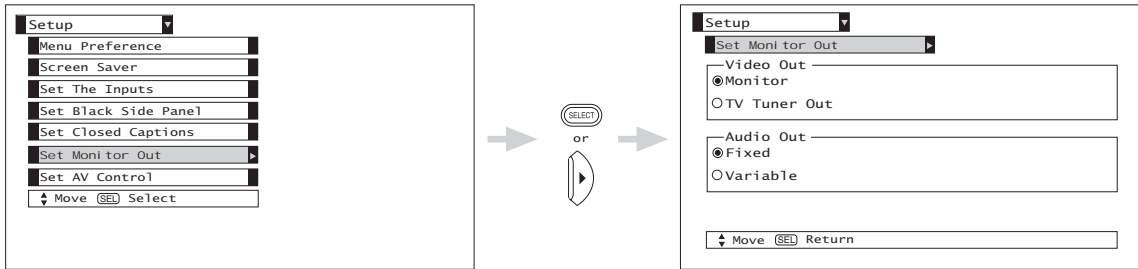

**Monitor-** Select Monitor to output the audio and video signals of the chosen input source (ANT A, ANT B, VID3-VID5) to a VCR or other A/V device.

**TV Tuner Out-** Select TV Tuner Out to output the audio and video signals of the last watched Antenna Source (ANT A, ANT B).

**Fixed-** Select Audio Out Fixed to have the Audio at fixed volume.

**Variable-** Select Audio Out Variable to have Audio settings that can be controlled.

Use CURSOR button ▼ to highlight the function to change then press the SELECT button to select the function.

Press EXIT to quit the menu or select SET MONITOR OUT to return to the previous menu.

**NOTE:** When TV Tuner Out is selected, Variable Audio Out will not be available (grayed out).

## Set AV Control

This feature will select the AV Control feature. Set this feature if you want to control some of the TV functions from an external home control system.

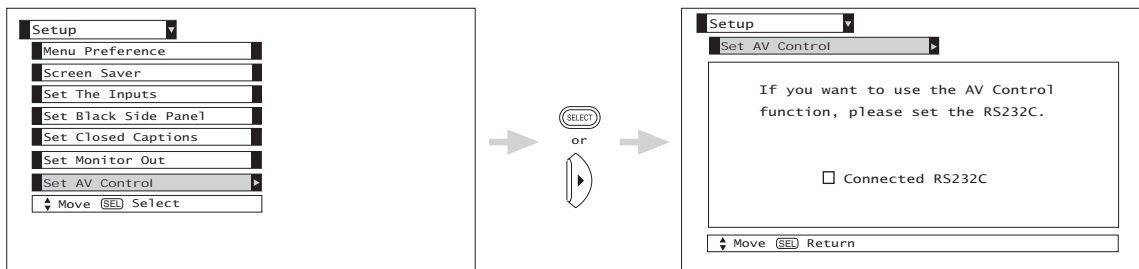

Use the CURSOR buttons and the SELECT button to check the Connected RS232C box.

Press EXIT to quit the menu or select SET AV CONTROL to return to the previous menu.

**NOTE:** For use with third party home Audio/Video control systems which are commercially available. Please see your dealer regarding these "non Hitachi" home control systems.



## Lamp Life

The lamp life may vary based on usage of the LCD Rear PTV. Turning on and off frequently may shorten the life of the lamp.

## Lamp Replacement

After extended use, if the TV picture turns dark, the color looks unusual or LAMP INDICATOR light turns on, then it is time to replace the lamp with a new lamp.

### WARNING:

The lamp gets very hot! The lamp may explode if improperly handled. To avoid injury, please observe the following precautions.

- Do not open lamp compartment or attempt to remove lamp assembly unless the lamp assembly is being replaced.
- Unplug the product's power cord from the AC outlet before attempting to replace the lamp assembly.
- If the lamp is in use when failure occurs or if the lamp has exploded, wait at least 30-45 minutes for the lamp to cool before opening the lamp compartment or touching the lamp assembly or any broken pieces.
- Broken lamp pieces can cause injury. Handle with gloves to avoid cuts.
- Do not place any foreign objects inside the lamp compartment.
- When installing a new lamp, follow handling instruction included with the new lamp. Do not touch glass surface of new lamp.
- This product contains lead and a lamp that contains mercury. Dispose of this product and its lamp in accordance with applicable environmental laws. For lamp recycling and disposal information, go to [www.lamprecycle.org](http://www.lamprecycle.org). For product recycling and disposal information, contact your local government agency or the Electronic Industries Alliance at [www.eiae.org](http://www.eiae.org) (in the US) or the Electronic Product Stewardship Canada at [www.epsc.ca](http://www.epsc.ca) (in Canada). For more information, call "1-800-HITACHI."

### CAUTION!

A "LAMP" indicator will light when lamp becomes hot. Unplug product's power cord from the AC outlet and allow lamp to cool for at least 30-45 minutes. If "LAMP" indicator is still lit, please contact your authorized service center (see page 70-71).

### NOTES:

- Contact your Hitachi dealer for a new lamp unit. Using other lamps may cause damage to the TV Set.  
LAMP TYPE: LM500 / LAMP PART # UX21513
- When replacing the lamp, let it cool down completely, for approximately 30 to 45 minutes after the power has been switched off and A.C. cord has been unplugged.
- Do not touch the glass of the new lamp or make it dirty which can shorten the life of the lamp and reduce the picture quality.
- Keep the lamp out of the reach of children and away from flammable materials.
- Do not pour water onto the removed lamp or put any object inside the lamp.
- Once the lamp is removed, do not put flammable materials and metal objects inside the lamp receptacle on the TV set. Do not touch the receptacle.
- Install the new lamp securely, otherwise the picture may become dark or it may cause severe overheating.
- Install the lamp cover correctly, otherwise power will not come on.

# LAMP REPLACEMENT



1. Turn off the power button and unplug the power cord.

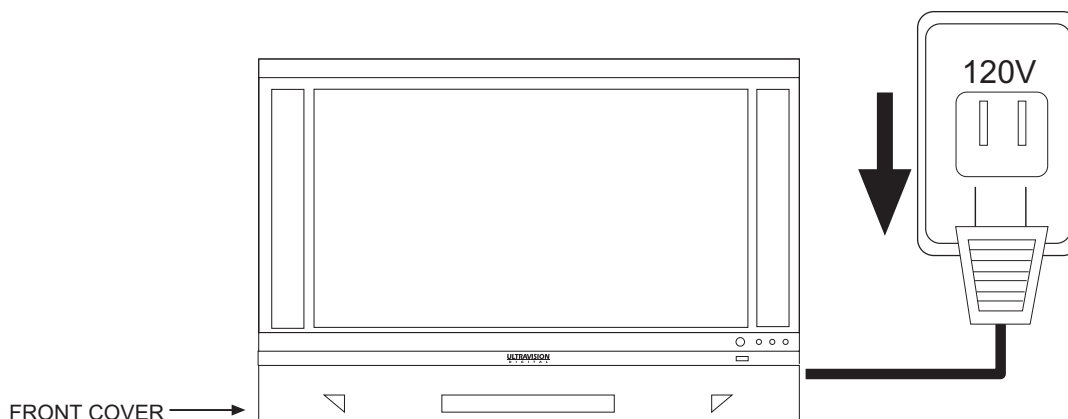

**CAUTION:** THE LAMP IS VERY HOT AND MAY CAUSE FIRE OR SEVERE BURNS. WAIT AT LEAST 30~45 MINUTES TO ALLOW THE LAMP TO COOL BEFORE PROCEEDING WITH LAMP REMOVAL.

2. Remove the front cover from the TV set. This is held by a snap on. Pull the front cover outwards until the quick snap on disengages.

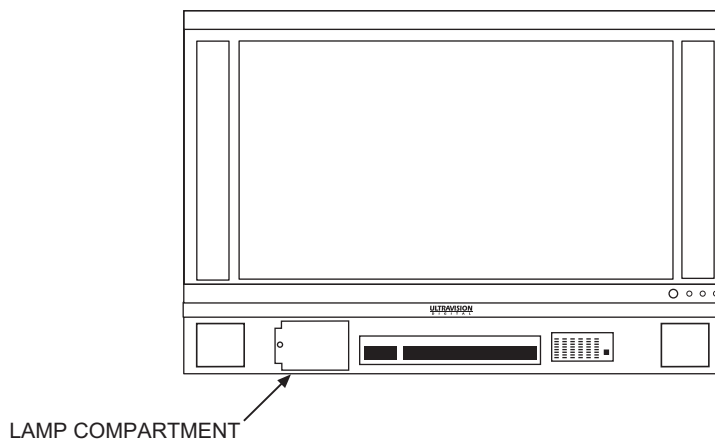

**NOTE:** This product contains lead and a lamp that contains mercury. Dispose of this product and its lamp in accordance with applicable environmental laws. For lamp recycling and disposal information, go to [www.lamprecycle.org](http://www.lamprecycle.org). For product recycling and disposal information, contact your local government agency or the Electronic Industries Alliance at [www.eiae.org](http://www.eiae.org) (in the US) or the Electronic Product Stewardship Canada at [www.epsc.ca](http://www.epsc.ca) (in Canada). For more information, call "1-800-HITACHI."



# LAMP REPLACEMENT

## LAMP REPLACEMENT

3. Remove the screw securing the lamp cover with a Phillips head screw driver as shown. Remove the lamp cover.

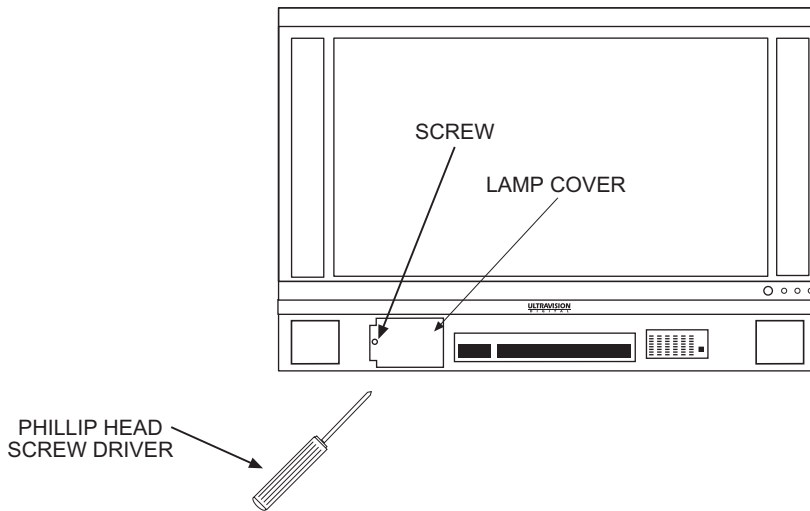

**CAUTION:** THE LAMP IS VERY HOT AND MAY CAUSE FIRE OR SEVERE BURNS. WAIT AT LEAST 30~45 MINUTES TO ALLOW THE LAMP TO COOL BEFORE PROCEEDING WITH LAMP REMOVAL.

4. Remove the two screws that hold the lamp in place. Remove the lamp unit by holding the lamp handle, then pulling outwards. Exercise caution when removing the lamp unit to avoid injury to your fingers.

**NOTE:** DO NOT PUT YOUR HAND IN THE LAMP STORAGE AREA AFTER THE LAMP UNIT IS REMOVED, YOU MAY GET BURNED.

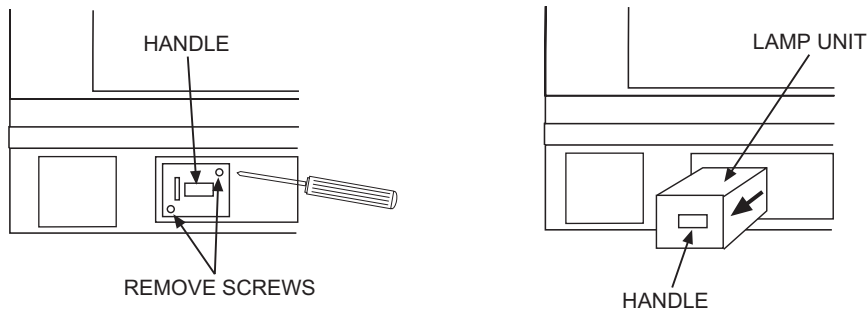

5. Replace with the new lamp.  
Place the removed lamp into the empty box of the replacement lamp. Do not touch the front glass of the new lamp or its receptacle. This may shorten the life of the lamp and reduce the picture quality.
- Push the lamp unit back to its original position.
  - Tighten the screws firmly on the lamp unit. If they are loose, the TV may not operate correctly.

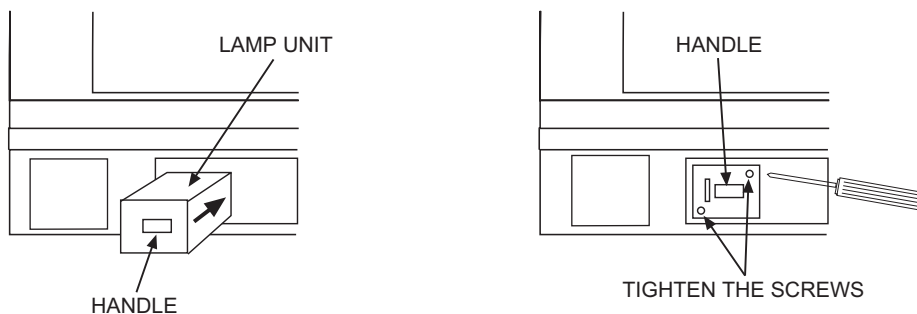



# LAMP REPLACEMENT



6. Without installing the lamp cover, the power will be off and the Lamp Indicator will flash (see page 8). Be sure to install the lamp cover by re-engaging the two clips and tighten the screws before turning the power on, otherwise it may cause unusual colors.

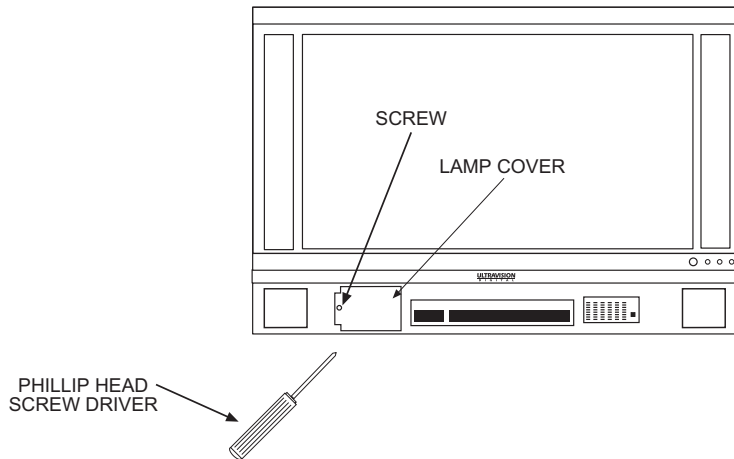

**NOTE:** IF POWER IS CONNECTED BEFORE THE LAMP COVER IS INSTALLED, THE POWER WILL BE OFF AND THE LAMP INDICATOR WILL FLASH (SEE PAGE 8 ).

7. Install the front cover as shown below. Put the front cover back in and align the snap on quick connect then push inwards holding the left and right side of the front cover until you hear a snap. Push the other snap on gently to make a good fit.

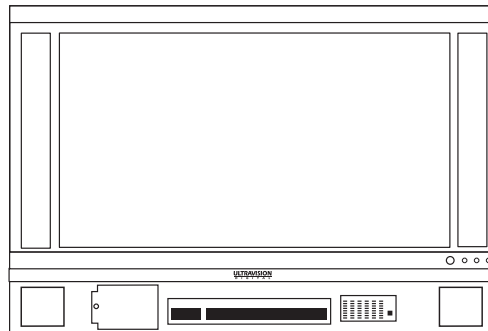

8. Plug power cord into AC outlet and turn on the power switch.

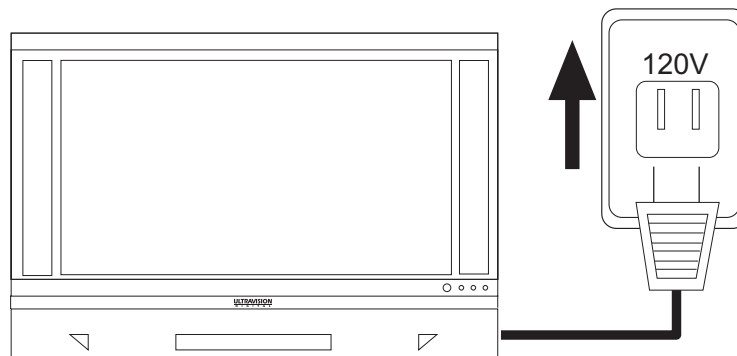

**NOTE:** This product contains lead and a lamp that contains mercury. Dispose of this product and its lamp in accordance with applicable environmental laws. For lamp recycling and disposal information, go to [www.lamprecycle.org](http://www.lamprecycle.org). For product recycling and disposal information, contact your local government agency or the Electronic Industries Alliance at [www.eiae.org](http://www.eiae.org) (in the US) or the Electronic Product Stewardship Canada at [www.epsc.ca](http://www.epsc.ca) (in Canada). For more information, call "1-800-HITACHI."



# CARE OF YOUR HITACHI TELEVISION AND YOUR REMOTE CONTROL

## DO

Dust the screen and cabinet with a soft cloth.

Clean the screen with a soft cloth moistened in warm water and dry with a soft cloth. A mild soap may be used if the screen is extremely dirty.

Place your Television away from extreme heat, humidity, and extremely dusty places.

Remove the plug from the wall outlet if your Television will not be used for a long period of time, for instances, when you go on vacation.

## DO NOT

Do not clean your screen or cabinet with strong cleaners, polishes or a chemically treated cloth.

Do not place rubber or vinyl products or cellophane tape on your Television.

Do not touch the screen too often.

Do not subject the remote control to shocks such as dropping it on the floor, etc. Physical damage to the precision parts may result.





Avoid placing the remote control in a high humidity place or getting it wet. Do not leave it on or near a heater. Excessive heat or moisture may cause the unit to cease operation.

When the batteries run down, remote control operation will become erratic or possibly stop altogether. Replace the old batteries with two new "AA" size batteries as soon as possible to preserve the remote control precodes that were set for the devices. Pressing a remote control button with a "DEAD" battery might erase all precodes in memory. Do not use an old battery with a new battery.

Exposure of the viewing screen to prolonged direct sunlight or heat may cause the screen to permanently warp, resulting in a distorted picture.

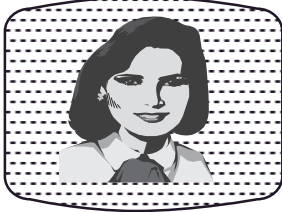
# RECEPTION PROBLEMS



	<ul style="list-style-type: none"><li>• <b>IGNITION NOISE:</b> Black spots or horizontal streaks may appear, picture may flutter or drift. Usually caused by interference from automobile ignition systems, neon lamps, electrical drills, and other electrical appliances.</li></ul>
	<ul style="list-style-type: none"><li>• <b>GHOSTS:</b> Ghosts are caused by the television signal following two paths. One is the direct path and the other is reflected from tall buildings, hills or some other objects. Changing the direction or position of the antenna may improve reception. Ghosting may also be caused by defects in the antenna system such as unshielded leads or connecting several sets to the same antenna without using multiple antenna couplers.</li></ul>
	<ul style="list-style-type: none"><li>• <b>SNOW:</b> If your receiver is located in the fringe area of a television station where the signal is weak, your picture may be marred by the appearance of small dots. When the signal is extremely weak, it may be necessary to install a special antenna to improve the picture.</li></ul>
	<p>The interference produces moving ripples or diagonal streaks, and in some cases, causes loss of contrast in the picture.</p>





# USEFUL INFO

## Features:

- Superfine Picture Quality  
1280 Line Horizontal Resolution
- Remote (Controls many PVR/VCR brands, cable boxes, satellite boxes, and other audio equipment).
- New Easy-to-Use (3-Language) On-Screen Menu
- Full Set of Input Jacks, including S-VIDEO
- COMPONENT VIDEO: Y-P<sub>B</sub>/P<sub>R</sub>
- Six Aspect Modes
- Closed Caption Decoder
- 2-Tuner Picture in Picture
- 2 Antenna Inputs (Either for Analog/Digital)
- Video Input Sensor
- 3 Dimensional Y/C Comb Filter
- Compatible with 1080i, 720p, 480p and 480i input signals.
- HDMI (High Definition Multimedia Interface) (High Bandwidth Digital Content Protection V1.1 compatible).
- **BBE** Technology.  
\*Licensed by BBE Sound, Inc. under USP5510752 and 5736897. BBE and BBE symbol are registered trademarks of BBE Sound, Inc. Manufactured under license from BBE Sound, Inc.
- **SRS** Technology.  
\*SRS and  symbol are trademarks of SRS Labs, Inc. SRS technology is incorporated under license from SRS Labs, Inc.
- **HDMI** Technology  
\*HDMI, the HDMI logo and High-Definition Multimedia Interface are trademarks or registered trademarks of HDMI Licensing LLC.

## Inputs:

- Power Input . . . . .AC 120V, 60Hz
- Stand-by Power . . . . .0.6W
- Power Consumption  
- Refer to rear panel at the back of the T.V.
- Antenna input impedance . . . . .75 Ohm
- Channel coverage . . . . .181ch.  
VHF-Band . . . . .2 ~ 13  
UHF-Band . . . . .14 ~ 69  
CATV Mid Band . . . . .A-5 ~ A-1  
. . . . .A-I  
Super Band . . . . .J-W  
Hyper Band . . . . .W+1 - W+28  
Ultra Band . . . . .W+29 - W+84
- Video . . . . .1.0Vp-p, 75 Ohm
- S-Video  
Luminance (Y) . . . . .1.0Vp-p, 75 Ohm  
Chrominance (C) . . . . .0.286Vp-p, 75 Ohm
- Component Video  
Luminance (Y) . . . . .1.0Vp-p, 75 Ohm  
Chrominance (P<sub>B</sub>/P<sub>R</sub>) . . . . .0.7Vp-p, 75 Ohm
- Audio input Impedance . . . . .47k Ohm
- Average input level . . . . .470mVrms
- HDMI . . . . .HDMI 19pin

## Outputs:

- Video . . . . .1.0Vp-p, 75 Ohm
- Audio (Fixed) . . . . .470mVrms, 1k Ohm
- S-Video  
Luminance (Y) . . . . .1.0Vp-p, 75 Ohm  
Chrominance (C) . . . . .0.286Vp-p, 75 Ohm

## Dimensions:

	<b>50V525E</b>	<b>60V525E</b>
• Height (in.)	35 1/2	40 1/4
(mm)	901.0	1023.0
• Width (in.)	54 5/8	63 3/8
(mm)	1387.0	1609.0
• Depth (in.)	16 3/8	20 1/2
(mm)	415.0	520.0
• Weight (lbs.)	114.0	128.5
(kg)	51.7	58.3

**NOTE:** Due to improvements, specifications in this operating guide are subject to change without notice.





## USEFUL INFO

---

### Hitachi Canada, LTD. Digital Media Division

---

*Should you have any questions regarding warranty, service, operation, or technical assistance, please contact:*

**In Canada:  
1-800-HITACHI  
(1-800-448-2244)**

**Monday - Friday EST 9:00am - 7:00pm  
Saturday EST 9:00am - 5:00pm**

*Look for your French Manual on the outside of the box.  
If the manual is missing, call*

**1-800-HITACHI  
(1-800-448-2244)**

*for a copy.*

---

*Pour de plus amples renseignements sur le service durant la période couverte par la garantie, sur le fonctionnement ou pour de l'assistance technique communiquez avec:*

**Au Canada:  
1-800-HITACHI  
(1-800-448-2244)**

**Lundi - Vendredi L'EST 9:00am - 7:00pm  
Samedi L'EST 9:00am - 5:00pm**

*La version français de votre manual se trouve a l'exterieur de la boîte.  
Si le manuel est manquant, coposez le*

**1-800-HITACHI  
(1-800-448-2244)**

*pour obtenir votre copie.*

**HITACHI CANADA, LTD.  
6740 Campobello Road  
Mississauga, ON L5N 2L8**



<b>A</b>	
Accessories	.4
Antennas (Connecting)	.5, 6
Aspect Ratio	.22, 43
Audio (Sound Enhancement)	
SRS	.41
BBE	.41
Audio Settings	.41-42
Audio Source	.42
Auto Color	.40
Auto Noise Cancel	.42
<b>B</b>	
Balance	.41
Bass	.41
Black Enhancement	.38
Brightness	.38
<b>C</b>	
Channel Manager	.44-47
Auto Channel Scan	.45
Channel Source	.44
Clock	
Time	.53
Date	.53
Closed Captions	
Analog Captions	.60
Color Management	.39
Color Temperature	.38
Color	.38
Contrast	.38
<b>D</b>	
DVI Input	.18
<b>E</b>	
Event Timer	.55
<b>H</b>	
HDMI	.11, 18
<b>I</b>	
Input Setup	.59
Inputs Button	.23
<b>L</b>	
Lamp	
Lamp Indicator	.8
Lamp Replacement	.62-65
Language	
Menu Language	.57
Locks	
Change Access Code	.48
Channel Lock	.48
Input Lock	.48
Front Panel Lock	.48
TV Time Lock	.48
Movie Ratings	.49
TV Ratings	.50
TV Ratings (Canadian - English)	.51
TV Ratings (Canadian - French)	.52
Loudness	.42
<b>M</b>	
Menu Preference	
Language	.57
Background	.58
Monitor Out	.10, 61
<b>N</b>	
Noise Reduction	.40
<b>P</b>	
Perfect Volume	.42
Picture Mode	.37
Picture-in-Picture (PIP)	.26-28
Picture-outside-Picture (POP)	.26
Power Button	.7
Power Indicator	.8
<b>R</b>	
Remote Control	
Functions	.20-33
Programming Codes	.33
Installing Batteries	.4
<b>S</b>	
Sharpness	.38
Speakers	.42
Connecting External Speakers	.5, 14
<b>T</b>	
Temperature Indicator	.8
Time	.53
Timers	.53-56
Tint	.38
Treble	.41
<b>V</b>	
Vertical Position	.43
Video Settings	.37-40









**HITACHI**