



Plantronics BackBeat™ 903/906

User Guide

Welcome

Thank you for purchasing the Plantronics BackBeat™ 903/906 headphones. This guide contains instructions for setting up and using your new headphones.

Before using this product, please refer to the For Your Safety guide for important safety, charging, battery, and regulatory information.

Registering Your Product

Visit the Customer Support area on www.plantronics.com to register your product online so we can provide you with the best service and technical support.

Getting Assistance

The Customer Support Team is ready to assist you. You can find answers to frequently asked questions, ask a question using e-mail, receive service over the Internet, or speak directly with a representative. Visit the Customer Support area on www.plantronics.com

NOTE If you are considering returning the headphones, please contact the Customer Support Team first.

NOTE For pairing your headphones to your Bluetooth® mobile phone, your Passkey (PIN code) is 0000.

Contents

Package Contents and Accessories	2
Charging Your Headphones or Bluetooth Adaptor	4
Pairing Your Headphones	5
Pairing Your Headphones and Phone/Device	5
Pairing Your Headphones and Bluetooth Adaptor	6
Adjusting the Fit	7
Headphones Phone Controls and Indicators	8
Headphones Music Controls and Indicators	11
Range	13
Troubleshooting	14
Troubleshooting with Bluetooth Adaptor	16
Product Specifications	18

Package Contents and Accessories

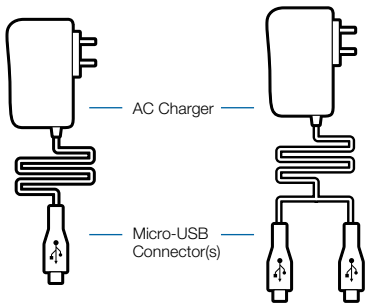

[BackBeat 903]

[BackBeat 906]

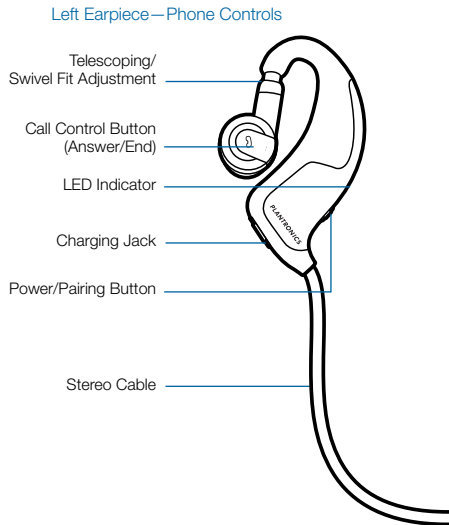

Package Contents and Accessories

Right Earpiece—Music Controls

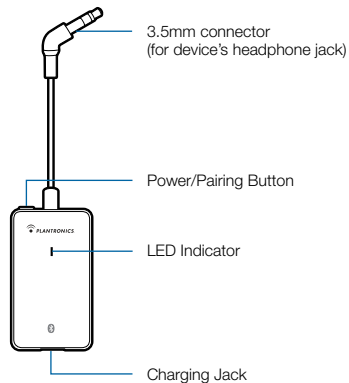
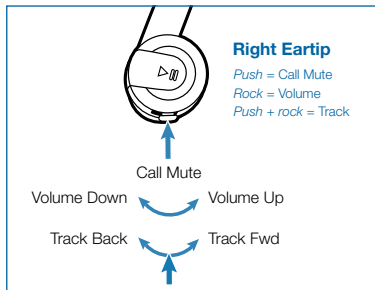
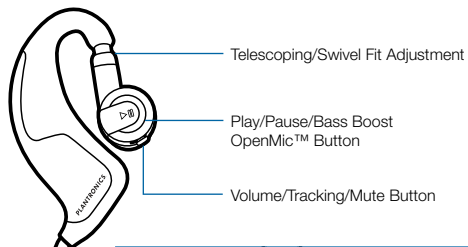

Bluetooth Adaptor
(included with
BackBeat 906 only)

Charging Your Headphones or Bluetooth Adaptor

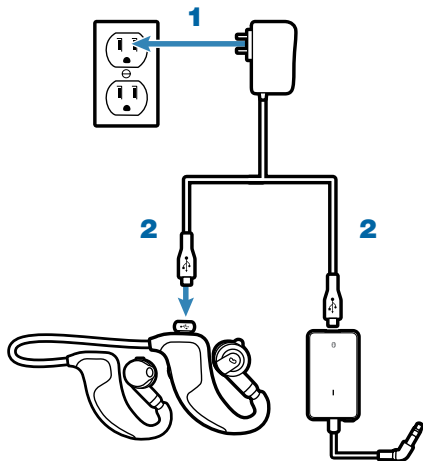

[BackBeat 906 shown]

- 1 Plug the AC charger into a power outlet.**
- 2 Connect the charger cable to the headphones or Bluetooth adaptor.**
- 3 Charge each for at least 1 hour before first time use, or 3 hours to fully charge.**
The LED indicator glows red while charging. When fully charged, LED will turn blue until unplugged. Do not use your headphones or Bluetooth adaptor while they are connected to the charger.

NOTE Never charge the battery where the temperature may fall below 0°C (32°F) or rise above 40°C (104°F)—for example, in an unattended motor vehicle.

CHARGING TIME

3 hours
Full charge



1 hour
Minimum charge
before first use



Pairing Your Headphones and Phone/Device

1 Turn on your phone's or device's Bluetooth® feature.

2 With the headphones powered off, press and hold the Power/Pairing button until the LED indicator flashes blue and red.

3 Use the phone or device menu to search for the Bluetooth headphones and select **9xxBackBeat**.

See your phone's or device's user guide for more information.

4 If prompted, enter **0000** for the PIN code/passkey.

Some phones also require that you accept the connection. Pairing is successful when the LED indicator flashes blue.

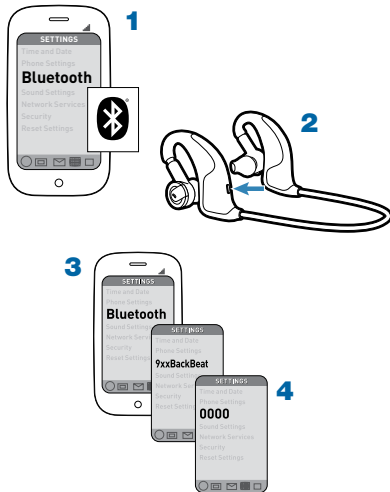

Pairing Your Headphones and Bluetooth Adaptor [BackBeat 906 only]

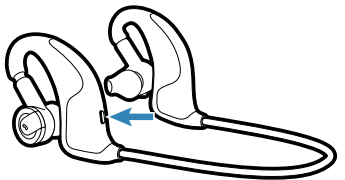

1

- 1** With the headphones powered off, press and hold the Power/Pairing button until the LED indicator flashes blue and red.
- 2** With the adaptor powered off, press and hold the Power/Pairing button until the LED indicator flashes blue and red.
- 3** The headphones and adaptor will both rapidly flash blue when paired successfully. Both are now ready for use. Plug the adaptor into the headphone jack of your device.

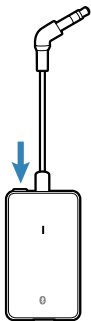

2

Adjusting the Fit

For optimal sound performance and a secure, comfortable fit, the headphones should be adjusted to rest gently in your ear and around the back of your neck.

- 1** Drape the stereo cable behind your neck.
- 2** Guide one earpiece behind your ear and secure the eartip inside your ear using the telescoping/swivel adjustments.
- 3** Repeat step 2 with the other earpiece and continue to adjust the fit in either ear until both eartips rest comfortably and securely in your ears.

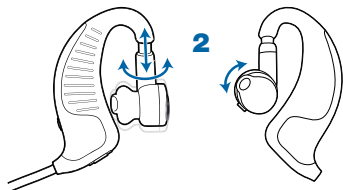

Headphones Phone Controls and Indicators

	Action	Indicator Light	Tone
Turn on the headphones	Press and hold the power/pairing button for 2 seconds.	Glows blue for 2 seconds, then turns off.	4 rising tones
Turn off the headphones	Press and hold the power/pairing button for 4 seconds.	Glows red for 4 seconds, then turns off.	4 falling tones
Answer/end a call	Tap the call control button.	3 blue flashes (repeating) while phone is ringing. Blue flash every 2 seconds while on a call.	3 low tones (repeating) while phone is ringing. Single low tone when call connects or disconnects.
Make a call	Enter the number on your phone and press send.	Blue flash every 2 seconds while call is in progress.	Brief tones, then ringing
Reject a call	Press and hold the call control button for 2 seconds.	None	Single long low tone
Check battery power	With headphones powered on, tap the power/pairing button. The indicator flashes red to show the charge level.	Red flashes: 1 2 3	Battery level: None More than 2/3 full 1/3 - 2/3 full Less than 1/3 full

Headphones Phone Controls and Indicators

	Action	Indicator Light	Tone
Low battery indicator	None	3 red flashes every 10 seconds	3 high tones every 10 seconds
Mute/unmute the call (call in progress)	Press in the volume/tracking/mute button.	None	Low and high tone to mute, then a single low tone every minute. High and low tone to unmute.
Adjust the call volume (call in progress)	Tap the volume/tracking/mute button forward (+) or backward (-).	None	Brief low tone (2 low tones when volume limit is reached)
⚠WARNING Do not use headphones at high volumes for an extended period of time. Doing so can cause hearing loss. Always listen at moderate levels. See www.plantronics.com/healthandsafety for more information on headphones and hearing.			
Redial	Double tap on control button	None	Double low tone
Voice dialing (trying to initiate call)	2 second press on call control button	None	Single low tone

Headphones Phone Controls and Indicators

	Action	Indicator Light	Tone
Transfer active call to/from headphones	2 second press on call control button when on an active call	None	Transfer call from headphones to phone: Double low tone Transfer call from phone to headphones: Single low tone followed by a double low tone
Online indicator on/off (default on)	Press mute and call control together when headphones is on.	Off: 4 blue flashes, then fade out On: 4 blue flashes, then fade in	Single low tone, then double low tone
Missed call indication	None	LED triple purple flash for 5 minutes	None

Headphones Music Controls and Indicators

	Action	Indicator Light	Tone
Play music	Tap the play/pause button.	None	None
OpenMic pause to hear	Tap the play/pause button when music is playing.	None	None
Disable OpenMic during music pause	While playing music, press and hold the mute button for 3 seconds. OpenMic feature will not activate during next music pause. Repeat action to enable OpenMic feature.	None	Low-high-low tones when disabling. High-low-high tones when enabling.
Move forward or back one track	Press and hold the volume/tracking/mute button forward or backwards for each track.	None	Single low tone for each track change.

Headphones Music Controls and Indicators

	Action	Indicator Light	Tone
Answer a call while listening to music	Tap the call control button. Music will pause during call.	3 blue flashes (repeating) while phone is ringing. Blue flash every 2 seconds while on a call.	3 low tones (repeating) while phone is ringing. Single low tone when call connects or when disconnects.
Reject a call while listening to music	Press and hold the call control button for 2 seconds.	None	Single long low tone
Adjust the volume of music	Tap the volume/tracking/mute button forward or backward.	None	Brief low tone (2 low tones when volume limit is reached)
Boost the bass	Press and hold the play/pause button for 2 seconds when music is playing.	None	Ascending tones when activating. Descending tones when deactivating.

NOTE To wirelessly stream stereo music or audio from a device to your headphones, your Bluetooth device must support the Bluetooth Advanced Audio Distribution Profile (A2DP) profile. To control music playback with your headphones, your Bluetooth device must also support the Audio/Video Remote Control Profile (AVRCP). The Bluetooth adaptor does not support the AVRCP profile, so you must use the controls on your device to control music playback.

Range

Bluetooth wireless technology provides a way for devices to communicate with each other using short-range radio frequency instead of wires. Any two Bluetooth devices can communicate as long as they both have Bluetooth turned on, they are within range, and they have been paired.

To maintain a connection, keep your headphones within 10 meters (33 feet) of your Bluetooth phone or adaptor. Ensure that your mobile phone is located on the left side of your body and that there are no obstructions between it and your headphones. If there are obstacles between your headphones and the phone or adaptor you may experience interference.

Audio quality degrades as you move out of range. When you are far enough away to lose the connection, you hear a high tone in the headphones.

The headphones attempt to reconnect for 30 seconds. If reconnection is successful, a low tone will be heard. If you move back in range after 30 seconds have passed, you can manually reconnect by pressing the call control button.

Troubleshooting

My mobile phone did not locate the headphones. Power off your mobile phone and headphones, then power on your phone. Repeat the pairing process on page 5.

Audio quality is poor. Make sure that the headphones fit your ears properly. See page 7.

Ensure that your mobile phone is located on the left side of your body and that there are no obstructions between it and your headphones.

Make sure that your headphones are within 10 meters (33 feet) of your mobile phone. Going outside of this range can impact audio quality. If your headphones do not automatically reconnect, see page 13.

I cannot hear stereo music from my phone. For stereo listening, your Bluetooth phone must support the Bluetooth Advanced Audio Distribution Profile (A2DP), which defines how Bluetooth devices stream stereo quality audio from one device to another. See your phone's user manual to determine if it has this Bluetooth profile.

I cannot control my music tracks. The adaptor and some stereo Bluetooth phones do not support the AVRCP profile for track controls. Use your audio device to change tracks.

Troubleshooting

Callers cannot hear me.

Mute may be turned on. See page 9.

Your headphones are out of Bluetooth range (10 meters/33 feet). Move closer to the Bluetooth device. If your headphones do not automatically reconnect, see page 5.

Be sure your headphones are paired with the audio device. See page 5.

Play and Pause are out of sync between my headphones and my audio source.

Ensure that your headphones are in play mode, and then initiate play mode from your audio source.

My earbuds need to be cleaned.

Remove the earbuds from the headphones. Wash the earbuds with warm soapy water, and rinse thoroughly. When the earbud are completely dry, reattach them to your headphones. See page 7.

None of the above issues are the problem, or my headphones still don't work.

Perform a system reset: While plugging in the AC charger, hold the power/pair button. The headphones will show a solid red or blue light when they have been successfully reset.

Troubleshooting with Bluetooth Adaptor [BackBeat 906 only]

I cannot hear music from my other audio source while the headphones are also paired to my Bluetooth A2DP mobile phone.

If you connect your mobile phone to your headphones before connecting your Bluetooth adaptor to your headphones, your mobile phone's A2DP Bluetooth profile may interfere with the functioning of the adaptor. Additionally, if you power off the adaptor or move out of Bluetooth range (10 meters/33 feet), you may lose the connection to your headphones. In either situation, you will need to:

- 1** Disconnect—but do not delete—your headphones from your mobile phone's list of paired devices (see your mobile phone's Bluetooth manager).
- 2** Reconnect your headphones to your adaptor.
- 3** Reconnect your headphones to your mobile phone (see your phone's Bluetooth manager).

I cannot tell if my Bluetooth adaptor is powered on.

When powered on, the LED on the adaptor flashes blue every 5 seconds. To power on the adaptor, press and hold the power button for 2 seconds until the LED flashes blue.

I cannot complete pairing with another Bluetooth device.

Your Bluetooth adaptor must be powered off when pairing a device to your headphones. See page 5.

Troubleshooting with Bluetooth Adaptor [BackBeat 906 only]

I do not get sound from my headphones when using the Bluetooth adaptor.

It can take up to 30 seconds for the devices to connect and for audio to stream via Bluetooth. After 30 seconds, if there is still no sound, press the play/pause button on the headphones.

Ensure that your audio device is not locked (see your device's user manual).

Ensure that you have properly paired the adaptor to your headphones. See page 6.

Check that the adaptor is plugged into an active stereo audio source.

Power off your headphones and adaptor, and then power both of them on again.

Make sure you have not moved out of Bluetooth range (10 meters/33 feet). See page 13.

Volume is too high/low when listening to audio, but fine when making a phone call.

Check the volume of the audio source device. Adjust as necessary.

Adjust the volume control on the headphones. See page 12.

I cannot make a VOIP call using the adaptor.

The adaptor is only intended for audio listening. If your computer has the Bluetooth Headset (HSP) and Hands-Free (HFP) profiles, you can pair your headphones to your computer for telephony applications like VOIP.

Product Specifications

Talk time*	Up to 7 hours	Bluetooth profiles (headphones)	HSP, HFP, Secure Simple Pairing, A2DP and AVRCP
Listening time*	Up to 7 hours	Power requirements	5V DC-180 mA
Standby time*	Up to 7 days	Storage/ operating temperature	0°-40°C (32°-104°F)
Range*	Up to 10 meters (33 feet)	Charging temperature	0°-40°C (32°-104°F)
Headphones weight	34 grams		
Battery type	Lithium ion polymer (embedded, non-replaceable)		
Charge time	3 hours for full charge		
Bluetooth version (headphones)	2.1 + EDR (Enhanced Data Rate)		

* Performance dependent on battery and may vary by device. Audio quality degrades as you move out of range and is dependent upon the device with which the headphones are paired.

For safety information, see the separate “For Your Safety” booklet.

For warranty information, see the Getting Started guide included in the box or visit www.plantronics.com



Altec Lansing is a Plantronics Company

www.plantronics.com

Plantronics B.V.
Scorpius 140
2132 LR Hoofddorp
Netherlands

©2009 Plantronics, Inc. All rights reserved. Plantronics, the Plantronics logo, Altec Lansing, BackBeat, OpenMic, QuickPair and Sound Innovation are trademarks or registered trademarks of Plantronics, Inc. Bluetooth® and the Bluetooth logo are registered trademarks of Bluetooth SIG and any use by Plantronics is under license.

Patents Pending

81378-03 Rev B

