

Contents

1.	INSTRUCTIONS FOR SAFE AND PROPER USE	4
2.	INSTALLATION OF THE APPLIANCE	6
3.	ADAPTATION TO DIFFERENT TYPES OF GAS	10
4.	FINAL OPERATIONS	12
5.	DESCRIPTION OF CONTROLS	14
6.	USE OF THE HOB	17
7.	USE OF THE OVEN	19
8.	AVAILABLE ACCESSORIES	20
9.	COOKING HINTS	21
10.	CLEANING AND MAINTENANCE	26
11.	EXTRAORDINARY MAINTENANCE	28
12.	PROBLEMS AND CAUSES	30



Thank you for choosing our product.

We advise you to read this manual carefully. It contains all necessary instructions for maintaining unaltered the appearance and functional qualities of the cooker.



INSTRUCTIONS FOR THE INSTALLER: these are for the **authorised person** who must carry out a suitable check of the gas system, install the appliance, set it functioning and carry out an inspection test.



INSTRUCTIONS FOR THE USER: these contain user advice, description of the commands and the correct procedures for cleaning and maintenance of the appliance.

Introduction

1. INSTRUCTIONS FOR SAFE AND PROPER USE



THIS MANUAL IS AN INTEGRAL PART OF THE APPLIANCE AND THEREFORE MUST BE KEPT IN ITS ENTIRETY AND IN AN ACCESSIBLE PLACE FOR THE WHOLE WORKING LIFE OF THE COOKER. WE ADVISE READING THIS MANUAL AND ALL THE INSTRUCTIONS THERE IN BEFORE USING THE COOKER.

INSTALLATION MUST BE CARRIED OUT BY QUALIFIED PERSONNEL IN ACCORDANCE WITH THE REGULATIONS IN FORCE. THIS APPLIANCE IS INTENDED FOR DOMESTIC USES AND CONFORMS TO CURRENT **REGULATIONS IN FORCE**. THE APPLIANCE HAS BEEN BUILT TO CARRY OUT THE FOLLOWING FUNCTIONS: **COOKING AND HEATING-UP OF FOOD**. ALL OTHER USES ARE CONSIDERED IMPROPER.

THE MANUFACTURER DECLINES ALL RESPONSIBILITY FOR IMPROPER USE.



DO NOT LEAVE THE PACKING IN THE HOME ENVIRONMENT. SEPARATE THE VARIOUS WASTE MATERIALS AND TAKE THEM TO THE NEAREST SPECIAL GARBAGE COLLECTION CENTRE.



IT IS OBLIGATORY FOR THE ELECTRICAL SYSTEM TO BE GROUNDED ACCORDING TO THE METHODS REQUIRED BY SAFETY RULES.



IMMEDIATELY AFTER INSTALLATION CARRY OUT A BRIEF INSPECTION TEST OF THE APPLIANCE, FOLLOWING THE INSTRUCTIONS BELOW. SHOULD THE APPLIANCE NOT FUNCTION, DISCONNECT IT FROM THE SUPPLY AND CALL THE NEAREST TECHNICAL ASSISTANCE CENTRE.

NEVER ATTEMPT TO REPAIR THE APPLIANCE.



ALWAYS CHECK THAT THE CONTROL KNOBS ARE IN THE POSITION **O** (OFF) WHEN YOU FINISH USING THE HOB.



NEVER PUT INFLAMMABLE OBJECTS INTO AN OVEN: IF THEY CATCH FIRE THEY COULD CAUSE A FIRE IN THE HOME.



THE I.D. PLATE WITH TECHNICAL DATA, REGISTRATION NUMBER AND BRAND NAME IS POSITIONED VISIBLY IN THE STORAGE COMPARTMENT. **THE PLATE MUST NOT BE REMOVED.**

Introduction



DO NOT PUT PANS WITHOUT PERFECTLY SMOOTH AND FLAT BOTTOMS ON THE HOB GRIDS.



DURING USE THE APPLIANCE BECOMES VERY HOT. TAKE CARE NOT TO TOUCH THE HEATING ELEMENTS INSIDE THE OVEN.



DO NOT USE CONTAINERS OR BROILERS THAT EXTEND BEYOND THE OUTER PERIMETER OF THE HOB.



IF THE APPLIANCE IS TO BE POSITIONED ON A PLATFORM IT MUST BE INSTALLED IN SUCH A WAY AS TO PREVENT IT FROM SLIPPING OFF THE FORMER.



THE APPLIANCE IS DESIGNED FOR USE BY ADULTS. DO NOT ALLOW CHILDREN OR INFIRM PERSONS TO GO NEAR OR PLAY WITH IT. DURING USE THE APPLIANCE BECOMES HOT. CARE SHOULD BE TAKEN TO AVOID TOUCHING THE HEATING ELEMENTS INSIDE THE OVEN. KEEP CHILDREN AWAY FROM THE OVEN.



REPLACED APPLIANCES MUST BE TAKEN TO A SPECIAL GARBAGE COLLECTION CENTRE.



WHERE THIS APPLIANCE IS INSTALLED IN MARINE CRAFT OR CARAVANS, IT SHALL NOT BE USED AS A SPACE HEATER.



DO NOT SPRAY AEROSOLS IN THE VICINITY OF THIS APPLIANCE WHILE IT IS IN OPERATION.



BEFORE THE APPLIANCE IS PUT INTO OPERATION, ALL THE LABELS AND PROTECTIVE FILMS APPLIED INSIDE OR OUTSIDE MUST BE REMOVED.



The manufacturer declines all responsibility for damage to persons or things caused by non-observance of the above prescriptions or by interference with any part of the appliance or by the use of non-original spares.



Instructions for the installer

2. INSTALLATION OF THE APPLIANCE



It is the law that all gas appliances are installed by **authorised persons**. Clearance around the cooker must comply with the requirements of AS5601.

2.1 Electrical connection

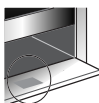

Make sure that the power line voltage matches the specifications indicated on the rating plate located inside the storage compartment.

This rating plate must never be removed.



On the power line, install a two-pole cut-off device with contact cut-off distance greater than or equal to **3 mm**, located in an easily accessible position near the unit.



The wire section on the cable must not be less than 2.5 mm^2 (3 x 2.5 cable), keeping in mind that the end to be connected to the cooker must have the ground wire (yellow-green) longer by at least 20 mm. Use only the special cables available at our Service Centres.

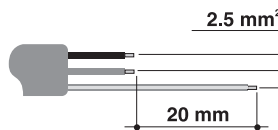

The manufacturer declines all responsibility for damage to persons or things caused by non-observance of the above prescriptions or by interference with any part of the appliance.

Overall dimensions: location of gas and electrical connection points (all measures in mm).

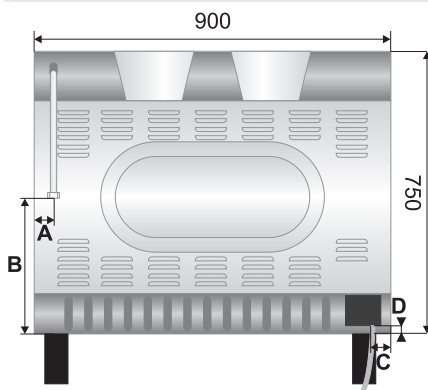

A	60
B	410
C	60
D	70

Instructions for the installer

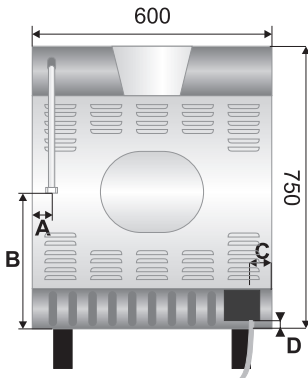

A	60
B	410
C	100
D	150

2.2 Gas connection

This appliance is suitable for installation with Natural Gas or ULPG (propane). Refer to page 12 for the relevant burner pressure and appropriate injector sizes. When the appliance is to be connected to Natural Gas then the pressure regulator supplied must be fitted to the gas inlet. A test point (for checking the gas pressure) is supplied either with the regulator or as a separate fitting in the case of ULPG (propane) appliances.

Connection of the appliance to the gas supply must be in accordance with the requirements of AS5601. A ½" BSP connector at the inlet is recommended and the gas supply line to the appliance must be of adequate length to allow sufficient withdrawal of appliance for service or disconnection and be:

1. annealed copper pipe or;
2. flexible hose according to AS/NZ1869 & be at least Class "B", 10 mm diameter.

The cooker must be installed with provision to allow the gas to be turned off and disconnected for servicing and removal of the appliance as required from the gas supply. Before the cooker is operated make certain all relevant parts are placed in the correct position.

When the installation is completed the installation connections of cooker will require to be leak tested, the burner operating pressure and flame checked and adjusted.

Warranty service calls do not cover these adjustments!

To check the operating pressure of the appliance it is recommended at least 2 large size burners are used. Ensure appliance is secured to wall when installation is completed.

N.G. The regulator supplied must be fitted to the ½ BSP thread at the rear of the appliance. An approved manual shut-off valve must be installed. The N.G. regulator must be checked and adjusted to 1.0kPa after installation.

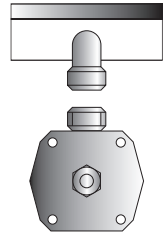



Instructions for the installer

ULPG: Can be connected to the inlet fitting directly. The pressure must be checked to ensure it is operating at 2.75kPa. A separate test point fitting must be installed between the piping & the appliance for the pressure to be checked to ensure it is operating at 2.75kPa.

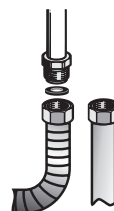

2.3 Room ventilation



Caution – This cooker may only be installed and operated in rooms permanently ventilated in accordance with current regulations. For proper operation of a gas appliance it is essential for the air necessary for combustion of the gas to be able to flow naturally into the room. Air must flow directly into the room through openings in its outside walls. This (these) opening (s) must have a free passage cross-section of at least 100 cm², or 200 cm² for appliances not equipped with gas safety device. These openings must be constructed so that they cannot be obstructed indoors or outdoors, and should preferably be close to the floor on the side opposite to the combustion gas discharge point. If it is not possible to make the openings in the room where the cooker is installed, the necessary air may be taken from an adjoining room, provided it is not a bedroom or a room with fire risk.

2.4 Clearance above and around domestic cookers

Extract from AS5601

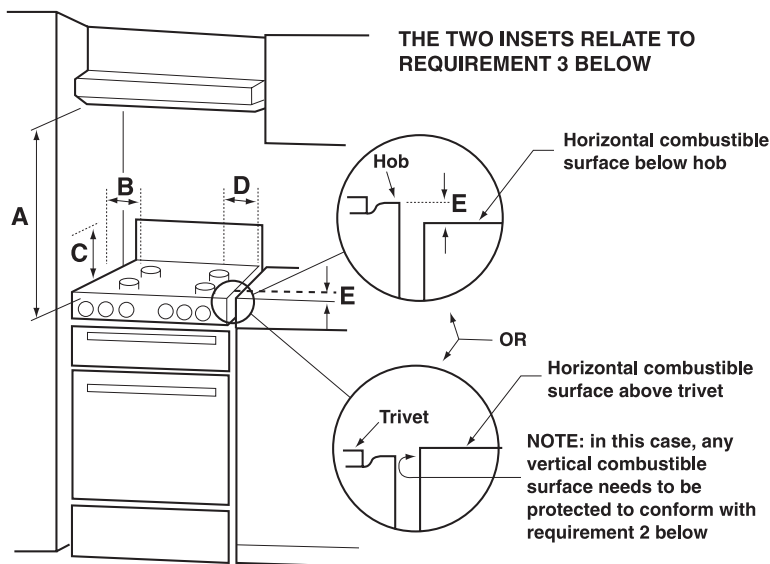

Instructions for the installer



REQUIREMENTS

- 1 Overhead clearances – (Measurement **A**)
Range hoods and exhaust fans shall be installed in accordance with the manufacturer's instructions. However, in no case shall the clearance between the highest part of the *hob* of the cooking *appliance* and a *range hood* be less than **600 mm** or, for an overhead exhaust fan, **750 mm**.

Any other downward facing *combustible surface* less than **600 mm** above the highest part of the *hob* shall be protected for the full width and depth of the cooking surface area in accordance with Clause 5.12.1.2. However, in no case shall this clearance to any surface be less than **450 mm**.
- 2 Side clearances – (Measurements **B & C**)
Where **B**, measured from the periphery of the nearest *burner* to any vertical *combustible surface*, is less than **200 mm**, the surface shall be protected in accordance with Clause 5.12.1.2 to a height **C** of not less than **150 mm** above the *hob* for the full dimension (width or depth) of the cooking surface area. Where the cooking *appliance* is fitted with a 'splashback', protection of the rear wall is not required.
- 3 Additional requirements for Freestanding and Elevated Cooking Appliances – (Measurements **D & E**)
Where **D**, the distance from the periphery of the nearest *burner* to a horizontal *combustible surface* is less than **200 mm**, then **E** shall be **10 mm** or more, or the horizontal surface shall be above the *trivet*. See insets above.

NOTES

- 1 Requirement 3 does not apply to a freestanding or elevated cooking appliance which is designed to prevent flames or the cooking vessels from extending beyond the periphery of the appliance.
- 2 The 'cooking surface area' is defined as that part of the appliance where cooking normally takes place and does not include those parts of the appliance containing control knobs.
- 3 For definition of hob, see Clause 1.4.64.
- 4 For definition of trivet, see Clause 1.4.109.
- 5 Consideration is to be given to window treatments when located near cooking appliances. See Clause 5.3.4.



Instructions for the installer

3. ADAPTATION TO DIFFERENT TYPES OF GAS



Before performing any cleaning or maintenance work, disconnect the appliance from the mains.

The hob of the cooker is adjusted for use with either **natural gas** at a pressure of 1.0kPa. If used with other types of gas, you have to replace the nozzles, then adjust the minimum flame on the gas taps. For nozzle replacement and burner adjustment operate as described in the following paragraph.

3.1 Replacement of nozzles on the hob

This operation requires no primary air regulation.

1. Extract the grids and remove all the caps and flame-spreader crowns;
2. unscrew the burner nozzles with a 7 mm socket wrench;
3. replace the nozzles according to the type of gas to be used and the description in paragraph "3.2 Burner and nozzle characteristics table".
4. Replace the burners in the correct position.

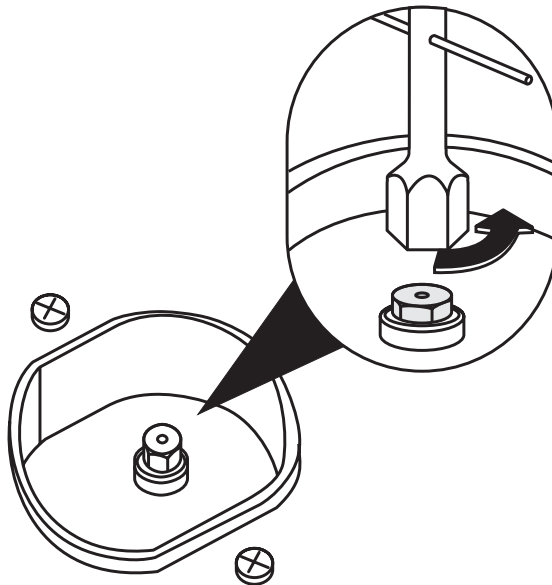

Instructions for the installer



3.2 Burner and nozzle characteristics table

Burner	ULPG (PROPANE) – 2.75 KPa		
	Nominal gas consumption (MJ/h)	Turn-down gas consumption (MJ/h)	Injector (mm)
Auxiliary	3.9	1.5	0,54
Semi rapid	6.3	1.5	0,68
Rapid	10	2.7	0,88
WOK	12.8	5.4	1,00

Burner	NG – 1.0 KPa		
	Nominal gas consumption (MJ/h)	Turn-down gas consumption (MJ/h)	Injector (mm)
Auxiliary	4	1.5	0,90
Semi rapid	7	1.5	1,20
Rapid	12	2.7	1,55
WOK	15	5.4	1,75



Instructions for the installer

4. FINAL OPERATIONS

After replacing the nozzles, reposition the flame-spreader crowns, the burner caps and the grids.

4.1 Adjustment of the hob burner minimum level for natural gas

Light the burner and take it to the minimum Δ .

Remove the knob and turn the regulation screw inside or next to the gas tap pin (depending on the model) until you get a suitable minimum flame.

Replace the knob and check burner flame stability: (rapidly turning the knob from maximum to minimum position, the flame should not go out). Repeat the operation on all the gas taps.

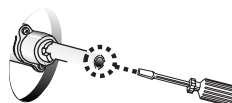
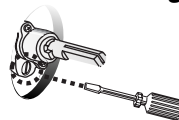

4.2 Arrangement of the burners on the hob

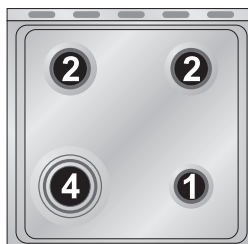
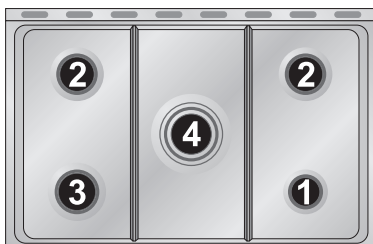

Burners

1	Auxiliary
2	Semi rapid
3	Rapid
4	Wok



4.3 Mounting the rear top skirtboard (where applicable)

- Loosen screws **A** located beneath the skirt.
- Loosen nuts **B**.
- Position the skirt above the top, taking care to align pins **C** with holes **D**.
- Secure the skirt to the top by tightening screws **E**.

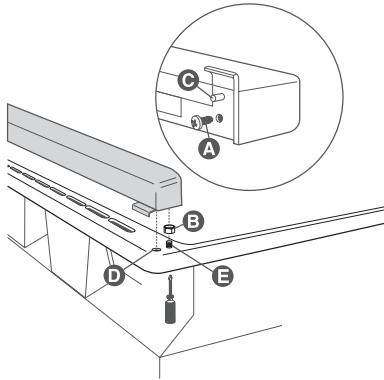

4.4 Wall fixing

- Stretch out the chain attached to the cooker horizontally so that the other end touches the wall.
- Mark the wall in the position where the hole is to be drilled.
- Drill the hole, insert the finned dowels and attach the chain.
- Move the cooker up against the wall.

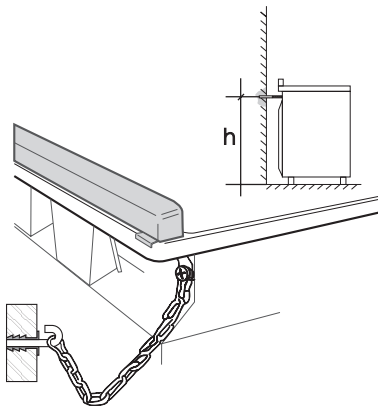



Instructions for the user

5. DESCRIPTION OF CONTROLS

5.1 Front control panel

All the cooker controls and commands are on the front panel.

DESCRIPTION OF SYMBOLS



FRONT RIGHT BURNER



BACK RIGHT BURNER



BACK LEFT BURNER



FRONT LEFT BURNER



CENTRAL BURNER



ELECTRIC OVEN THERMOSTAT



ELECTRIC OVEN FUNCTION KNOB

HOB BURNER COMMAND KNOB

The flame is lit by pressing the knob and turning it anticlockwise to minimum flame Δ . To adjust the flame turn the knob between maximum (Δ) and minimum (Δ). The burner goes out when the knob is returned to the position \bigcirc .



ELECTRIC OVEN THERMOSTAT KNOB

Selection of cooking temperature is carried out by turning the knob clockwise to the required temperature, between 50° and 260°C .

If the appliance has an electric oven, the warning light will come on when the oven is heating up. When it goes out it means that the required temperature has been reached. Regular flashing means that oven temperature is being constantly maintained at the programmed level.

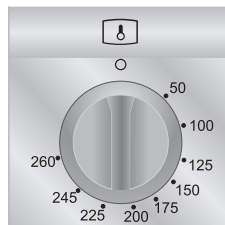

Instructions for the user



ELECTRIC OVEN CONTROL KNOB

Each of the functions listed below can be used (except the oven light and the small grill) only together with the correct temperature thermostat regulation as described on page 14 of this manual.

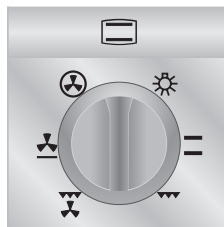

OVEN LIGHT



UPPER AND LOWER HEATING ELEMENT



GRILL ELEMENT



GRILL ELEMENT + VENTILATION



LOWER HEATING ELEMENT + VENTILATION



VENTILATED HEATING ELEMENT + VENTILATION





Instructions for the user

5.2 Digital timer



This component allows an on-off beeper to be set to indicate the end of the cooking time. It is therefore just a timer, with no programming functions.





LIST OF FUNCTIONS



-  TIME SETTING BUTTON
-  DECREASE TIME KEY
-  INCREASE TIME KEY

5.2.1 Clock adjustment

When using the oven for the first time, or after a power failure, the display flashes regularly and indicates **0:00**. Press the keys  and use the keys  or  to set the current time.

5.2.2 Setting the timer

To set the timer, press the  key and keep it pressed until the required number of minutes is shown. When the  key is released, after 5 seconds the countdown will start; once this finishes, an acoustic device will sound.

During the countdown the display will show the  symbol; pressing the  key displays the current time for 5 seconds.



5.2.3 Deactivating the acoustic device

The acoustic device stops sounding automatically after seven minutes. It can be deactivated in manual mode by pressing the  key.

5.2.4 Adjusting alarm volume

The volume can be adjusted (3 settings) while it is in operation by pressing the  key.

5.2.5 Changing the set data

The timer data set can be modified at any moment by pressing the  or  keys.



6. USE OF THE HOB

6.1 Lighting of the hob burners



Before lighting the hob burners check that the flame caps are in the correct position and that their burner caps are in place, making sure that the holes **A** in the flame caps correspond to the spark plugs and thermocouples.

Before lighting the burners **lift the glass cover**; before lowering the cover, turn off all the burners and wait for them to cool down.



The optional grid **B** is for use with “woks” (Chinese pans).

To prevent deterioration of the hob we have equipped the cooker with a raised pan stand **C** to be placed underneath pans more than 26 cm in diameter.

The supplied reduction rest **C** is also used for small pans.

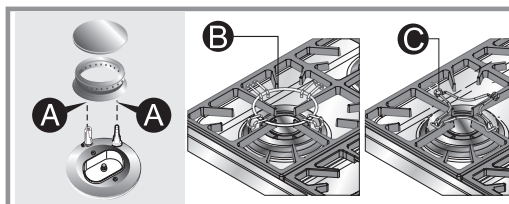

The drawing next to each knob shows the corresponding burner. The appliance has an electronic lighting device. Simply press and turn the knob anticlockwise to the minimum flame symbol Δ , until the ring is lit. Hold the knob down for a few seconds to allow the thermocouples to heat up. The burner may go out when the knob is released: this is because the thermocouple has not been sufficiently heated. Repeat the operation holding down the knob for a little longer. This operation is not necessary for burners without thermocouples.



For models with thermocouples, if the burner should accidentally go out, a safety device will be activated which stops the gas flow even if the tap is open.



Instructions for the user

6.2 Practical advice for using the hob burners



For better use of the burners and lower gas consumption, use covered containers that are proportional in size to the burner to prevent the flame from licking the sides (see paragraph “6.3 Diameter of containers”). When water reaches the boiling point, lower the flame so that it doesn't overflow. To avoid burns or damage to the hob, all recipients or griddle plates must be placed within the perimeter of the hob. All containers have to have a flat and smooth bottom. When using fats or oils, be extremely careful that they don't overheat and catch fire.

If the flame accidentally goes out, turn off the control knob and wait at least 1 minute before trying to re-light the burner.

6.3 Diameter of containers

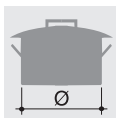
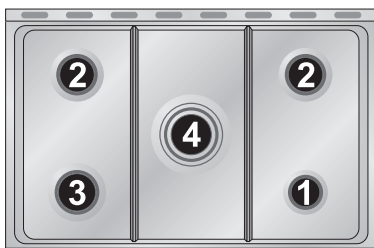

BURNERS

Ø min. and max. (in cm)

1 Auxiliary	12-14
2 Semi rapid	16-24
3 Rapid	18-26
4 WOK	18-26

Instructions for the user



7. USE OF THE OVEN

7.1 Warnings and general advice



Using the oven and the grill for the first time, heat them to the maximum temperature (260°C) for as long as it takes to burn off any production oil residues which could give a nasty flavour to the food. After a power cut, the oven display will flash intermittently and show **0:00**. To adjust refer to paragraph "5.2 Electronic Programmer".



To prevent any steam in the oven creating problems, open the door in two stages: half open (5 cm approx.) for 4-5 seconds and then fully open. To access food, always leave the door open as short a time as possible to prevent the temperature in the oven from falling and ruining the food.



7.2 Use of the electric grill

For short cooking procedures, such as the final crisping of meat which is already cooked, select the static grill function  and turn the thermostat knob to the maximum temperature. The fan grill function allows actual cooking procedures to be carried out, thanks to the fan function which ensures that the heat penetrates into the food. For this cooking mode, select the fan grill function  and turn the thermostat knob to the ideal cooking temperature (never set at more than 220). Cooking procedures in this mode must never last more than 60 minutes.

All cooking with the grill must be done with the door closed to prevent the knobs and the front panel of the equipment to overheat.

How to use the grill

Food should be flavoured and basted with oil or melted butter before cooking. An oven dish should be used to contain the sauces. The food should be placed on the oven shelf which is positioned on one of the guides supplied with the different ovens, following the instructions below:



FOOD	GRILLE ON THE SHELF
Flat or thin meat	3
Rolled roast joints	2 – 3
Poultry	2 – 3



Instructions for the user

WARNING

- The oven accessories which may come into contact with food are made from materials which conform to the standing directives.
- During and after use the accessible parts of the oven may be very hot, and children must always be kept at a distance.

8. AVAILABLE ACCESSORIES

The oven has **4 support** for positioning plates and racks at various heights.



Oven grill: for cooking food on plates, small cakes, roasts or food requiring light grilling.



Plate grill: for placing above plate for cooking foods that might drip.

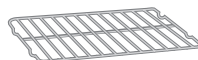

Oven plate: useful for catching fat from foods on the grill above.

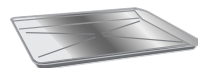

Pastry plate: for baking cakes, pizza and oven desserts.



Accessories on Request

You can order the lower base and self-cleaning oven panels through Authorised Assistance Centres.

Instructions for the user



9. COOKING HINTS

9.1 Traditional cooking



FUNCTION SWITCH



THERMOSTAT SELECTOR SWITCH FROM 50° TO 260°C

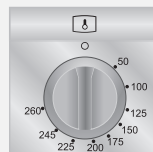

This traditional cooking method, in which heat comes from above and below, is suitable for cooking food on a single level. You have to pre-heat the oven until the set temperature is reached. Place the food in the oven only after the thermostat indicator light has turned off. Very fatty meats may be put in when the oven is still cold. Put frozen meat in immediately, without waiting for it to thaw. The only precaution you need to take is to set the temperature about 20°C lower and cooking time about 1/4 longer than you would for fresh meat.



Use high-rim pans to prevent fat splashing and dirtying the sides of the oven.



9.2 Hot-air cooking



FUNCTION SWITCH



THERMOSTAT SELECTOR SWITCH FROM 50° TO 260°C

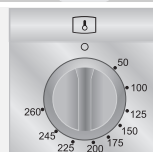

This system is suitable for cooking on several levels, including different types of food (fish, meat etc.), without the tastes and smells mingling. Air circulation in the oven ensures a uniform distribution of heat. Pre-heating is not necessary.



Instructions for the user



Multiple cooking is possible as long as the cooking temperature of the different foods is the same.

9.3 Grill cooking



FUNCTION SWITCH



THERMOSTAT SELECTOR SWITCH FROM 50° TO 260°C

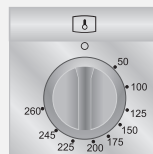

Permits rapid browning of foods. You are advised to place the pan in the highest guide. For short-term cooking of small quantities, place the grid in the third guide from the bottom. For long-term cooking and grills, put the grid in the lowest guide in accordance with the size of the pieces.

Make sure that the oven door is closed during cooking.

9.4 Hot-air grilling



FUNCTION SWITCH



THERMOSTAT SWITCH FROM 50° TO 200°C

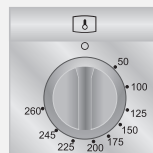

Ensures uniform heat distribution with greater heat penetration into the food. Food will be lightly browned on the outside and remain soft inside.

Keep the oven door closed during cooking. Heating up time must not exceed 60 minutes.

Instructions for the user



9.5 Delicate cooking



FUNCTION SWITCH



THERMOSTAT SELECTOR SWITCH FROM 50° TO 260°C



Ideal for pastries and cakes with wet covering and little sugar and damp desserts in moulds. Excellent results can also be achieved in completing cooking at the bottom and with dishes requiring heat in the lower area in particular. The plate is best inserted at bottom level.

9.6 Defrosting



FUNCTION SWITCH



THERMOSTAT SWITCH IN POSITION 0



The flow of air produced by the fan ensures quicker defrosting. The air circulating inside the oven is at room temperature.



The advantage of defrosting at room temperature is that it does not alter the taste and appearance of the food.



Instructions for the user

9.7 Recommended cooking table

Cooking times, especially meat, vary according to the thickness and quality of the food and to consumer taste.

TRADITIONAL COOKING



	LEVEL FROM BELOW	TEMPERATURE (°C)	TIME IN MINUTES (*)
FIRST COURSES			
LASAGNE	2 - 3	210 - 230	30
OVEN-BAKED PASTA	2 - 3	210 - 230	40
MEAT			
ROAST VEAL	2	170 - 200	30 - 40 / KG.
ROAST BEEF	2	210 - 240	30 - 40 / KG.
ROAST PORK	2	170 - 200	30 - 40 / KG.
CHICKEN	2	170 - 200	45 - 60
DUCK	2	170 - 200	45 - 60
GOOSE - TURKEY	2	140 - 170	45 - 60
RABBIT	2	170 - 200	50 - 60
LEG OF LAMB	1	170 - 200	15 / KG.
ROAST FISH	1 - 2	170 - 200	ACCORDING TO DIMENSIONS
PIZZA	1 - 2	210 - 240	40 - 45
DESSERTS			
MERINGUE	1 - 2	50 - 70	60 - 90
SHORT PASTRY	1 - 2	170 - 200	15 - 20
CIAMBELLA	1 - 2	165	35 - 45
SAVOYARDS	1 - 2	150	30 - 50
BRIOCHES	1 - 2	170 - 200	40 - 45
FRUIT CAKE	1 - 2	170 - 200	20 - 30

(*) = WITH PREHEATED OVEN

GRILLING



	LEVEL FROM BELOW	TIME IN MINUTES	
		FIRST SURFACE	SECOND SURFACE
PORK CHOPS	4	7 - 9	5 - 7
FILLET OF PORK	3	9 - 11	5 - 9
FILLET OF BEEF	3	9 - 11	9 - 11
LIVER	4	2 - 3	2 - 3
VEAL ESCALOPES	4	7 - 9	5 - 7
HALF CHICKEN	3	9 - 14	9 - 11
SAUSAGES	4	7 - 9	5 - 6
MEAT-BALLS	4	7 - 9	5 - 6
FISH FILLETS	4	5 - 6	3 - 4
TOAST	4	2 - 4	2 - 3

Instructions for the user



HOT-AIR COOKING



	LEVEL FROM BELOW	TEMPERATURE (°C)	TIME IN MINUTES
FIRST COURSES			
LASAGNE	2	190 - 210	20 - 25
OVEN-BAKED PASTA	2	190 - 210	25 - 30
CREOLE RICE	2	190 - 220	20 - 25
MEAT			
ROAST VEAL	2	150 - 170	65 - 90
ROAST PORK	2	150 - 160	70 - 100
ROASTED BEEF	2	160 - 170	65 - 90
FILLET OF BEEF	2	160 - 180	35 - 45
ROAST LAMB	2	130 - 150	100 - 130
ROAST BEEF	2	170 - 180	40 - 45
ROAST CHICKEN	2	170	70 - 90
ROAST DUCK	2	160 - 170	100 - 160
ROAST TURKEY	2	150 - 160	160 - 240
ROAST RABBIT	2	150 - 160	80 - 100
ROAST HARE	2	160 - 170	30 - 50
ROAST PIGEON	2	140 - 170	15 - 25
FISH	2 - 3	150 - 170	ACCORDING TO DIMENSIONS
PIZZA	2 - 3	210 - 240	30 - 50
DESSERTS (PASTRIES)			
CIAMBELLA	2 - 3	150 - 170	35 - 45
FRUIT CAKE	2 - 3	170 - 190	40 - 50
SPONGE-CAKE	2 - 3	190 - 220	25 - 35
BRIOCHES	2 - 3	160 - 170	40 - 60
STRUDEL	1 - 2	150	25 - 35
SAVOYARD PUDDING	2 - 3	160 - 170	30 - 40
BREAD	2 - 3	190 - 210	40
TOAST	1 - 2	220 - 240	7



Instructions for the user

10. CLEANING AND MAINTENANCE

10.1 Cleaning stainless steel and enamelled versions



To maintain stainless steel in good condition it must be cleaned regularly after each use, once it has cooled down.

10.1.1 Ordinary Daily Cleaning

To clean and preserve the stainless steel surfaces, always use **only** specific products that do not contain abrasives or chlorine-based acids.

How to use: pour the product on a damp cloth and wipe the surface, rinse thoroughly and dry with a soft cloth or deerskin.

10.1.2 Food stains or residues

Do not use metallic sponges or sharp scrapers: they will damage the surface.

Use normal non-abrasive products for steel, and a wooden or plastic tool if necessary.

Rinse thoroughly and dry with a soft cloth or deerskin.

Do not allow residues of sugary foods (such as jam) to set inside the oven. If left to set for too long, they might damage the enamel lining of the oven.



10.2 Cleaning of the hob components

10.2.1 Grids

Remove the grids and clean them in warm water with a non-abrasive detergent, taking care to remove any incrustations. Replace them on the hob.

Continuous contact of the grids with the flame can cause the paint near the hot areas to be altered. This is completely natural and does not compromise the functionality of the component.

10.2.2 Burner caps and flame cap crowns

The caps and flame-spreader crowns are extractable to facilitate cleaning. Wash them in hot water with non-abrasive detergent, taking care to remove any incrustations, and wait until they are **perfectly dry**.

WARNING: do not wash these components in the dishwasher.

Replace the flame-spreader crowns, checking that they are positioned in their housing with their respective caps, taking care that flame-spreader holes **A** correspond to the spark plugs and the thermocouples.

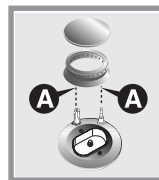

Instructions for the user



10.2.3 The spark plugs and thermocouples

To function properly the spark plugs and thermocouples must always be clean (on the models which are equipped with them). Check them regularly and clean with a damp cloth if necessary. Any dry residues can be removed with a toothpick or a needle.

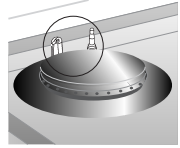

10.2.4 The burners

The burners can be left to soak in hot water and detergent.

10.3 Cleaning of oven



For best oven upkeep clean regularly after having allowed to cool. Take out all removable parts.

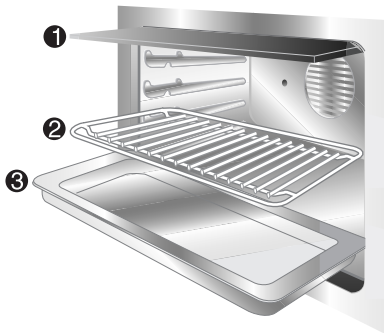
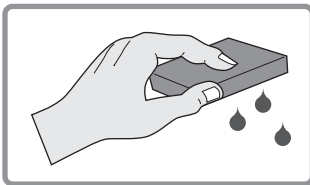

- Clean the oven grill with hot water and non-abrasive detergent. Rinse and dry.

10.4 Door glass

The door glass should always be kept clean. Use absorbent kitchen paper to clean. In case of tough spots, clean with a damp sponge using regular detergent.



Instructions for the user

11. EXTRAORDINARY MAINTENANCE

Ovens periodically require small maintenance interventions or replacement of parts subject to wear and tear such as gaskets, electric bulbs etc. Specific instructions for each intervention of this type appear below.



Before performing any operations requiring access to powered parts, switch off the power supply to the machine.

11.1 Lubrication of gas taps

With time it may happen that the gas taps get blocked and hard to turn. Clean them inside and re-grease them. **This operation must be done by an authorised person.**



11.2 Replacement of light bulbs

Remove cover **A** by twisting anticlockwise, replace bulb **B** with another similar bulb. Refit the cover **A**.

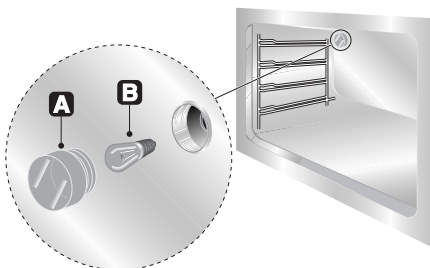

Only use oven bulbs (T 300°C).

11.3 Dismantling of the doors

Hold the door on both sides with both hands near hinges **A** and raise levers **B**. Lift up the door forming an angle of about 45° and remove. To refit, slide the hinges **A** in the grooves, drop the door and release levers **B**.

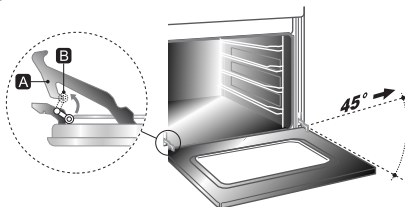

Instructions for the user



11.4 Oven door gaskets

The door gaskets can be dismantled for thorough cleaning of the ovens. Before removing the gaskets the oven doors must be removed as previously described. With the doors removed, raise the tabs at the corners as shown in the figure.



11.5 Preventive maintenance

This appliance does not need any special maintenance. However, a few simple operations have to be carried out periodically to prevent malfunctioning:



Burners: the burners must be cleaned after every use to ensure correct combustion; make sure that all the openings and flame ports are clean and free of obstacles, and that the burners rest firmly on their supports.

Gas connection: the gas connection must be checked periodically (at least every 2 years). Each time the cooker is moved the connection may be stressed: test it for leakages using special sprays or a solution of soap and water.

Flexible pipes: if a flexible pipe is used, it must be inspected periodically (once a year) for leakages: if the surface of the pipe appears rigid and cracked, disconnect immediately the cooker from the gas supply and replace the pipe with a new one.

Valves: if the gas valves get stuck or hard to turn, they need to be cleaned and re-greased; this operation must be carried out by an authorised person.

Oven gasket: with time the oven gasket may harden and crack on the surface, resulting in leakage of heat from the oven and higher temperatures on the control panel and knobs. Check it periodically (once a year) and replace it if necessary.



Instructions for the user

12. PROBLEMS AND CAUSES

Each of the following cases is caused by an abnormal operation of the appliance and should be dealt with by a authorised person: please contact your local dealer or Service Center in case you detect any of these malfunctioning.

PROBLEM	CAUSE	WHAT TO DO
The flame is very long with bright yellow tips. Black deposits on the bottom of the pans.	Defect of comburent air or incorrect injectors.	Call Service Center.
The flame is very short and noisy. The flame moves away from the burner ports.	Excess of comburent air.	Call Service Center.
The flame extinguishes when the burner knob is set to the low flame position.	Incorrect adjustment of the minimum heat input or excess of comburent air.	Call Service Center.
The valve knob is hard to rotate.	Gas valve worn out or needs lubrication.	Call Service Center.
The cooker suddenly stops working during operation of the oven. The electronic programmer is not operating.	Overheating of the appliance.	Let the appliance cool down: the safety thermal cut-out will self-reset when the temperature has decreased to a correct value. Should the problem arise again, call the Service Center.



914773010/ D