

1	INSTRUCTIONS FOR SAFE AND PROPER USE	4
2	INSTALLATION OF THE APPLIANCE	6
3	ADAPTATION TO DIFFERENT TYPES OF GAS	8
4	FINAL OPERATIONS	11
5	DESCRIPTION OF FRONT PANEL CONTROLS	13
6	USE OF THE COOKING HOB	15
7	USE OF THE OVEN	17
8	ELECTRONIC PROGRAMMER (ONLY ON EQUIPPED MODELS)	20
9	DIGITAL TIMER (CERTAIN MODELS ONLY)	22
10	ANALOGUE CLOCK (ONLY ON EQUIPPED MODELS)	22
11	CLEANING AND MAINTENANCE	23
12	EXTRAORDINARY MAINTENANCE	25



THESE INSTRUCTIONS ARE VALID ONLY FOR END USER COUNTRIES WHOSE IDENTIFICATION SYMBOLS APPEAR ON THE COVER OF THIS MANUAL.



INSTRUCTIONS FOR THE INSTALLER: these are for the **qualified technician** who must carry out a suitable check of the gas system, install the appliance, set it functioning and carry out an inspection test.



INSTRUCTIONS FOR THE USER: these contain user advice, description of the commands and the correct procedures for cleaning and maintenance of the appliance.

1 INSTRUCTIONS FOR SAFE AND PROPER USE



THIS MANUAL IS AN INTEGRAL PART OF THE APPLIANCE AND THEREFORE MUST BE KEPT IN ITS ENTIRETY AND IN AN ACCESSIBLE PLACE FOR THE WHOLE WORKING LIFE OF THE COOKER. WE ADVISE READING THIS MANUAL AND ALL THE INSTRUCTIONS THEREIN BEFORE USING THE COOKER. ALSO KEEP THE SERIES OF NOZZLES SUPPLIED. INSTALLATION MUST BE CARRIED OUT BY QUALIFIED PERSONNEL IN ACCORDANCE WITH THE REGULATIONS IN FORCE. THIS APPLIANCE IS INTENDED FOR DOMESTIC USES AND CONFORMS TO CURRENT **REGULATIONS IN FORCE**. THE APPLIANCE HAS BEEN BUILT TO CARRY OUT THE FOLLOWING FUNCTIONS: **COOKING AND HEATING-UP OF FOOD**. ALL OTHER USES ARE CONSIDERED IMPROPER.
THE MANUFACTURER DECLINES ALL RESPONSIBILITY FOR IMPROPER USE.

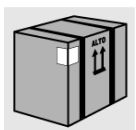

DO NOT LEAVE THE PACKING IN THE HOME ENVIRONMENT. SEPARATE THE VARIOUS WASTE MATERIALS AND TAKE THEM TO THE NEAREST SPECIAL GARBAGE COLLECTION CENTRE.

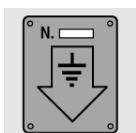

IT IS OBLIGATORY FOR THE ELECTRICAL SYSTEM TO BE GROUNDED ACCORDING TO THE METHODS REQUIRED BY SAFETY RULES.

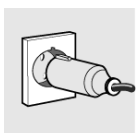

WHEN LINKING UP TO MAINS BY PLUG AND SOCKET, MAKE SURE THAT BOTH ARE COMPATIBLE AND CONNECT BY MEANS OF A POWER CABLE COMPLYING WITH APPLICABLE REGULATIONS.
THE SOCKET MUST BE ACCESSIBLE AFTER THE APPLIANCE HAS BEEN BUILT IN.
NEVER UNPLUG BY PULLING ON THE CABLE.



IMMEDIATELY AFTER INSTALLATION CARRY OUT A BRIEF INSPECTION TEST OF THE APPLIANCE, FOLLOWING THE INSTRUCTIONS BELOW. SHOULD THE APPLIANCE NOT FUNCTION, DISCONNECT IT FROM THE SUPPLY AND CALL THE NEAREST TECHNICAL ASSISTANCE CENTRE.
NEVER ATTEMPT TO REPAIR THE APPLIANCE.

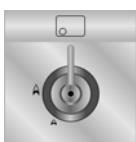

WHEN NOT IN USE, MAKE SURE THAT THE CONTROL KNOBS ARE IN THE CORRECT (OFF) POSITION ● .



NEVER PUT INFLAMMABLE OBJECTS IN THE OVEN: THEY COULD BE ACCIDENTALLY LIGHTED AND CAUSE FIRES.

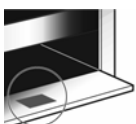

THE I.D. PLATE WITH TECHNICAL DATA, REGISTRATION NUMBER AND BRAND NAME IS POSITIONED VISIBLY IN THE STORAGE COMPARTMENT.
THE PLATE MUST NOT BE REMOVED.



DO NOT PUT PANS WITHOUT PERFECTLY SMOOTH AND FLAT BOTTOMS ON THE COOKING HOB GRIDS.



DO NOT USE CONTAINERS OR BROILERS THAT EXTEND BEYOND THE OUTER PERIMETER OF THE HOB.

Introduction

GB-IE

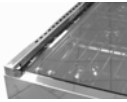

LOWER THE GLASS COVER SLOWLY AND BY HAND.

WARNING: THE GLASS COVER MAY SHATTER IF IT OVERHEATS. SWITCH OFF ALL RINGS AND WAIT FOR THEM TO COOL DOWN BEFORE CLOSING THE COVER.



DURING USE THE APPLIANCE BECOMES VERY HOT. TAKE CARE NOT TO TOUCH THE HEATING ELEMENTS INSIDE THE OVEN.



THE APPLIANCE IS DESIGNED FOR USE BY ADULTS. DO NOT ALLOW CHILDREN TO GO NEAR OR PLAY WITH IT.

WHEN OPERATING THE GRILL ALL ACCESSIBLE PARTS COULD BECOME VERY HOT: **KEEP OUT OF THE WAY OF CHILDREN.**



IF THE APPLIANCE IS TO BE POSITIONED ON A PLATFORM IT MUST BE INSTALLED IN SUCH A WAY AS TO PREVENT IT FROM SLIPPING OFF THE FORMER.



THIS APPLIANCE IS MARKED ACCORDING TO THE EUROPEAN DIRECTIVE 2002/96/EC ON WASTE ELECTRICAL AND ELECTRONIC EQUIPMENT (WEEE).

THIS GUIDELINE IS THE FRAME OF A EUROPEAN-WIDE VALIDITY OF RETURN AND RECYCLING ON WASTE ELECTRICAL AND ELECTRONIC EQUIPMENT.



BEFORE THE APPLIANCE IS PUT INTO OPERATION, ALL THE LABELS AND PROTECTIVE FILMS APPLIED INSIDE OR OUTSIDE MUST BE REMOVED.



The manufacturer declines all responsibility for damage to persons or things caused by non-observance of the above prescriptions or by interference with any part of the appliance or by the use of non-original spares.



2 INSTALLATION OF THE APPLIANCE



It is the law that all gas appliances are installed by **competent persons**. Corgi gas installers are approved to work to safe and satisfactory standards. All gas installation, servicing and repair work must be in accordance with the gas safety regulations 1984 (installation and use) as amended 1990. It can be placed against walls higher than the hob as shown in the drawings A and B relating to the installation classes. Wall units or extractor hoods located above the hob must be at least 750 mm away from it.

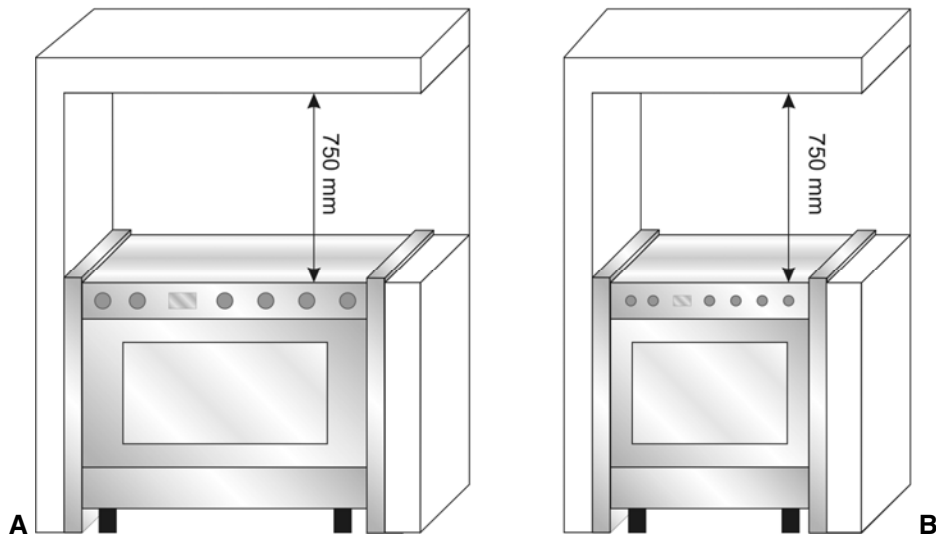

2.1 Electrical connection

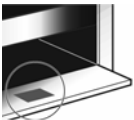

Make sure that the power line voltage matches the specifications indicated on the rating plate located inside the storage compartment.

This rating plate must never be removed.



If the appliance is hooked-up to the supply by means of a fixed connection, install a multipolar cut-out device on the line, with contact opening distance equal to or greater than **3 mm**, located near the appliance and in an easily reachable position.

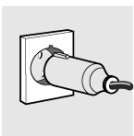

Hook-up to the supply may be fixed or with plug and socket. In the latter case the plug and socket must be suitable for the cable employed and conform with the regulations in force. Regardless of the type of connection, earthing of the appliance is absolutely obligatory. Before connection make sure that the supply line is suitably earthed. Avoid the use of reducers, adapters or shunts.1



If the power cable is replaced, the wire section on the new cable must not be less than 1.5 mm^2 (3 x 1.5 cable), keeping in mind that the end to be connected to the hob must have the ground wire (yellow-green) longer by at least 20 mm. Use only H05V2V2-F cable or similar which has a maximum temperature of 90°C . This must be done by a specialised technician, who must connect the cooker to the electricity supply according to the diagram shown here.

L = brown

N = blue

 = yellow-green.

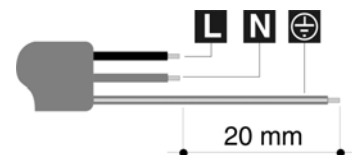



Instruction for the installer

GB-IE

2.2 Ventilation requirements



The room containing the appliance should have an air supply in accordance with B.S. 5440 part 2 1989.

1. All rooms require an opening window or equivalent, and some rooms will require a permanent vent as well.
2. For room volumes up to 5 m³ an air vent of 100 cm² is required.
3. If the room has a door that opens directly to the outside, and the room exceeds 1 m³ no air vent is required.
4. For room volumes between 5 m³ and 10 m³ an air vent of 50 cm² is required.
5. If there are other fuel burning appliances in the same room B.S. 5440 part 2 1989 should be consulted to determine the air vent requirements.
6. This appliance must not be installed in a bed sitting room of less than 20 m³ or in a bathroom or shower room.

Windows and permanent vents should therefore not be blocked or removed without first consulting a Corgi gas installer.

Failure to install appliances correctly is dangerous and could lead to prosecution.

2.3 Connecting to natural and LPG gas

(Please see connection diagram)

Make the connection to the appliance using flexible bayonet style hose in accordance to B.S. 669. The hose connection at the rear of the appliance has a ½” BSP internal thread. Please use seal **C** between the flexible connection **L** and the appliance supply tube **B**. When making the connection, make sure that no stress of any kind is applied to the cooker and that the hose does not touch any sharp edges.

If connecting to LPG the bayonet hose must have red bands on it.

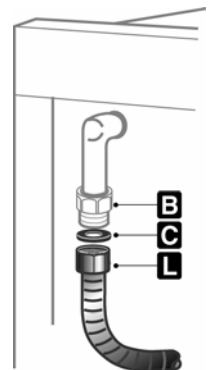



3 ADAPTATION TO DIFFERENT TYPES OF GAS



Before performing any cleaning or maintenance work, detach the appliance from the electrical socket.

The cooker hob is set for **natural gas G20** (2H) at a pressure of 20 mbar for cookers with maxi oven, and for **LPG G30/G31** (3+) at a pressure of 28/37 mbar for cookers with gas-bottle compartments. In the case of functioning with other types of gas the burner nozzles must be changed and the minimum flame adjusted on the gas taps. To change the nozzles, proceed as described below.

3.1 Replacement of nozzles on the hob

This operation requires no primary air regulation.

1. Extract the grids and remove all the caps and flame-spreader crowns;
2. unscrew the burner nozzles with a 7 mm socket wrench;
3. replace the nozzles according to the type of gas to be used and the description in paragraph "3.2 / 3.3 Burner and nozzle characteristics table".
4. Replace the burners in the correct position.

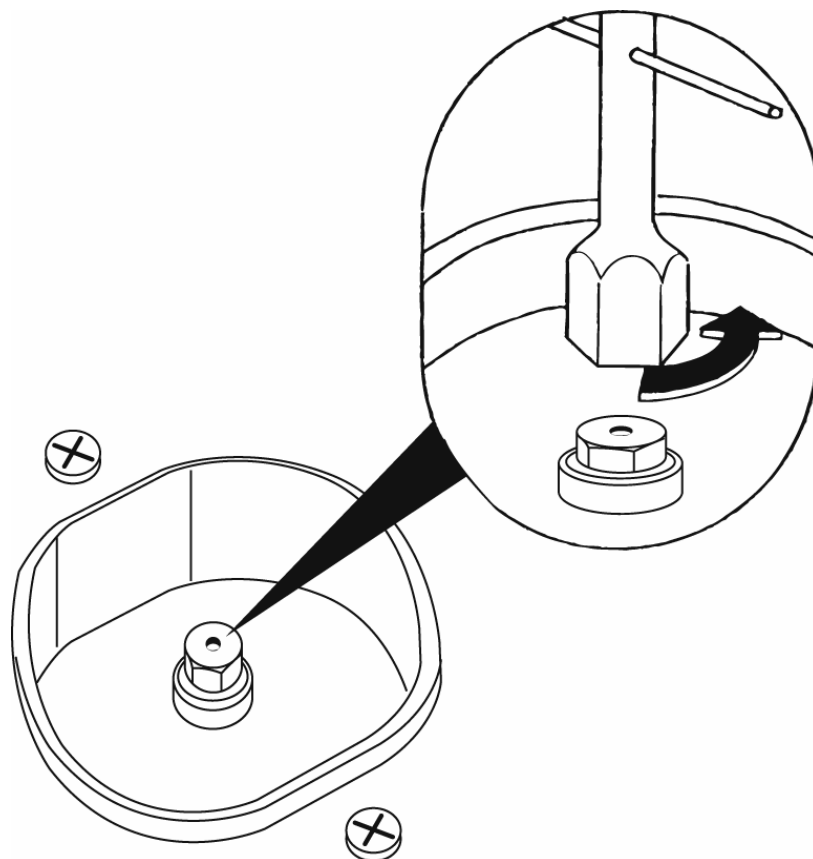



Instruction for the installer

GB-IE

3.2 Burner and nozzle characteristics table

Burner	Rated heating capacity (kW)	LPG – G30/G31 28/37 mbar				
		Nozzle diameter 1/100 mm	By-pass mm 1/100	Reduced Flowrate (W)	Flowrate g/h G30	Flowrate g/h G31
Auxiliary	1	50	30	350	73	71
Semi-rapid	1.75	65	33	450	127	125
Rapid	2.5	79	45	800	181	179
Triple crown	3.5	94	65	1500	254	250
Oven	5.2	110	59	1200	377	371
Grill	4	100	//	//	290	285

Burner	Rated heating capacity (kW)	NATURAL GAS – G20 20 mbar	
		Nozzle diameter 1/100 mm	Reduced Flowrate (W)
Auxiliary	1	72	350
Semi-rapid	1.75	97	450
Rapid	2.5	108	800
Triple crown	3.5	133	1500
Oven	5.2	164	1200
Grill	4	150	//



3.3 Arrangement of burners on cooking hob



BURNERS

1. Auxiliary
2. Semi-rapid
3. Rapid
4. Triple crown

3.4 Adjustment of the oven burner (only for gas oven models)

To adjust the oven burners follow the procedure described below from inside the oven:

- Open the oven door;
- Remove the oven dish and shelf.
- Lift up the oven floor and remove.



3.4.1 Replacement of the oven and grill burner nozzles

- Loosen the fixing screws **A** on the oven burner.
- Push the burner **B** towards the right to get to the nozzle.
- Use a 13 socket wrench to change the nozzle, fitting the one for the type of gas to be used (see point "3.2/3.3 Table of burner and nozzle characteristics").

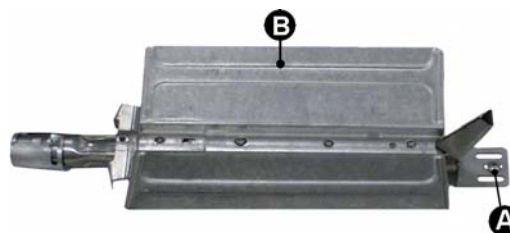

3.4.2 Regulation of the primary air on the oven and grill burners

- Loosen the register screws "A" on the air regulation coupling.
- Turn the register coupling "B" to the position corresponding to the type of gas to be used according to the table below.
- Tighten the register screws and mount the seals.
- Once the operation is completed reassemble the burner correctly.

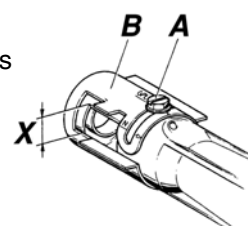

	NATURAL (N)	G30/G31 (LPG)
X =	5 mm	15 mm



Instruction for the installer

GB-IE

4 FINAL OPERATIONS

After replacing the nozzles, reposition the flame-spreader crowns, the burner caps and the grids.



Following adjustment to a gas other than the preset one, replace the gas adjustment label fixed to the appliance with the one corresponding to the new gas. This label is in the packet together with the nozzles.

4.1 Regulation of the hob burner minimum level for natural gas

Light the burner and turn it to the minimum position Δ . Extract the gas tap knob and turn the adjustment screw at the side of the tap rod until the correct minimum flame is achieved.

Replace the knob and check burner flame stability: (rapidly turning the knob from maximum to minimum position, the flame should not go out). Repeat the operation on all the gas taps.

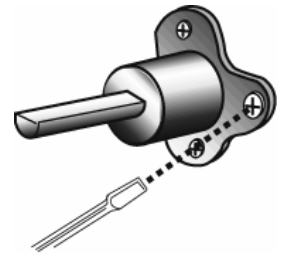

For models with valves, keep the knob at minimum level for about 1 minute to keep the flame lit and to activate the safety device.

4.2 Regulation of the hob burner minimum level for LPG

For regulating the minimum with LPG, the screw at the side of the tap rod must be turned clockwise all the way.

The bypass diameters for each individual burner are shown in paragraph “3.2 Burner and nozzle characteristics table”. Once the regulation has been completed, replace the seal on the by-passes using paint or similar materials.

4.3 Regulation of the oven burner minimum level

The oven thermostat is equipped with a by-pass to regulate the minimum level, which is visible underneath the thermostat knob.

When the gas type is changed, the by-pass should be regulated as follows:

1. Turn on the oven burner to maximum for 10/15 minutes with the door closed and without the floor. Turn the knob to the minimum temperature, remove the knob and regulate using a flat screwdriver.
2. For LPG turn the by-pass screw clockwise as far as it will go. The by-pass diameter is shown in the paragraph “3.2 / 3.3 Burner and nozzle characteristics table”.
3. For natural gas, regulate the by-pass so that turning the thermostat knob from minimum to maximum the flame remains stable and constant. Once the regulation has been completed, replace the seal on the by-pass using paint or similar materials. Close the oven door and make sure that the burner stays on minimum.



4.4 Mounting the rear top skirtboard (where applicable)

- Loosen screws **A** located beneath the skirt.
- Loosen nuts **B**.
- Position the skirt above the top, taking care to align pins **C** with holes **D**.
- Secure the skirt to the top by tightening screws **E**.

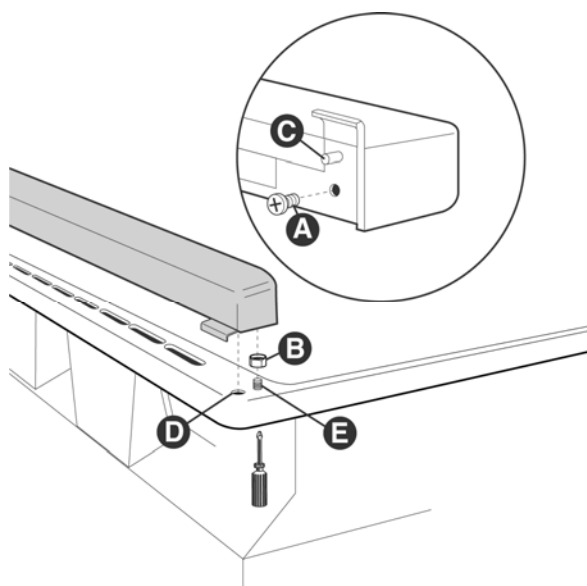

4.5 Positioning and levelling of the appliance (Depending on models)

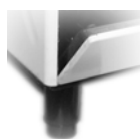

Having carried out the electricity and gas hook-up, level the appliance using the four adjustable legs. For best cooking the appliance must be perfectly level.

Depending on the model you have purchased, the foot height adjustment range may vary from 70 to 95 mm and from 110 to 160 mm. These heights refer to the distance between the highest point of the foot (fixed part) and the lowest point (movable part which rests on the floor).



Instruction for the user

GB-IE

5 DESCRIPTION OF FRONT PANEL CONTROLS

All the oven controls are grouped together on the front panel. The table below provides a description of the symbols used.

		FRONT RIGHT BURNER		FRONT CENTRAL BURNER
		BACK RIGHT BURNER		CENTRAL BURNER
		BACK LEFT BURNER		GAS OVEN THERMOSTAT KNOB
		FRONT LEFT BURNER		OVEN LIGHT / ROTISSERIE / GRILL SWITCH
		BACK CENTRAL BURNER		BURNER IGNITION BUTTON
				OVEN LIGHT SWITCH



If the cooker is equipped with an electronic programmer, before using the oven make sure that the symbol appears on the display. See paragraph "8.1 Clock adjustment".

COOKING HOB BURNER COMMAND KNOB (CERTAIN MODELS ONLY)

The flame is lit by pressing the knob and turning it anticlockwise to minimum flame . To adjust the flame turn the knob between maximum () and minimum () settings. The burner goes out when the knob is returned to the position .

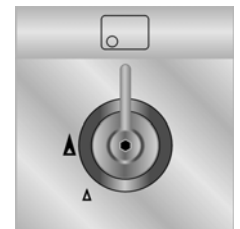

BURNER IGNITION BUTTON (CERTAIN MODELS ONLY)

In the models fitted with this button, the flame is ignited by turning the knob anticlockwise to the minimum flame setting , while simultaneously pressing this button. To adjust the flame, turn the knob to the zone between the maximum () and the minimum () settings. To turn out the burner, return the knob to the position.

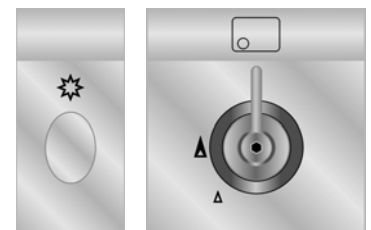

Instruction for the user



GAS OVEN THERMOSTAT KNOB (CERTAIN MODELS ONLY)

This knob is used to ignite the gas burner inside the oven. The cooking temperature is selected by turning the knob anticlockwise to the desired setting, between Min. and 275°C.
For information on how to ignite the gas oven, see point " 7.3 Use of the gas oven ".



OVEN LIGHT / ROTISSERIE / GRILL SELECTOR KNOB (CERTAIN MODELS ONLY)

This knob allows the user to activate the Grill / Rotisserie function or to switch on the light inside the oven to check the point reached in cooking the food.
CAUTION: IT IS NOT POSSIBLE TO OPERATE THE GAS OVEN AND THE GRILL / ROTISSERIE SIMULTANEOUSLY.

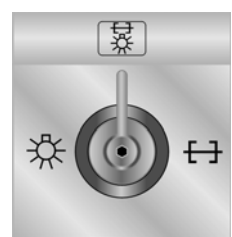

MINUTE COUNTER KNOB (CERTAIN MODELS ONLY)

Turn clockwise to wind up the alarm and set to the desired time.
Time is expressed in minutes (maximum 55 minutes).
Adjustment is continuous so that intermediate times between markings can also be set. Alarm activation at end of pre-set time does not turn off the oven (no end of cooking).

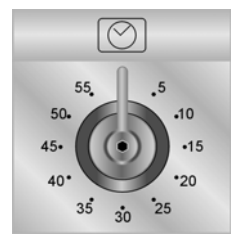

OVEN LIGHT SWITCH (CERTAIN MODELS ONLY)

This switch allows the light inside the oven to be switched on at any moment.
Tramite questo tasto è anche possibile far partire il motorino girarrosto..





Instruction for the user

GB-IE

6 USE OF THE COOKING HOB

6.1 Lighting of the cooking hob burners



Before lighting the hob burners check that the flame caps are in the correct position and that their burner caps are in place, making sure that the holes **A** in the flame caps correspond to the spark plugs and thermocouples.

Before lighting the burners **lift the glass cover**; before lowering the cover, turn off all the burners and wait for them to cool down.



The optional grid **B** is for use with “woks” (Chinese pans).

To prevent deterioration of the hob we have equipped the cooker with a raised pan stand **C** to be placed underneath pans more than 26 cm in diameter.

The supplied reduction rest **C** is also used for small pans.

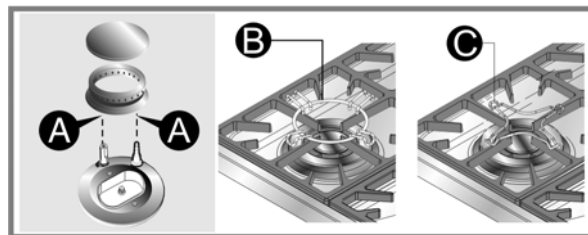

The drawing next to each knob shows the corresponding burner. The appliance has an electronic lighting device. In the models that's not fitted with a burner ignition button, simply press and turn the knob anticlockwise to the minimum flame symbol Δ , until the ring is lit. In the models fitted with a burner ignition button turn the knob **A** as described earlier, while pressing the button **B** at the same time. Hold the knob down for a few seconds to allow the thermocouples to heat up. The burner may go out when the knob is released: this is because the thermocouple has not been sufficiently heated. Repeat the operation holding down the knob for a little longer. This operation is not necessary for burners without thermocouples.

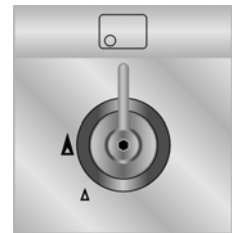

For models with thermocouples, if the burner should accidentally go out, a safety device will be activated which stops the gas flow even if the tap is open.

6.2 Practical advice for using the cooking hob burners



For better use of the burners and lower gas consumption, use covered containers that are proportional in size to the burner to prevent the flame from licking the sides (see paragraph “6.3/6.4 Diameter of containers”). When water reaches the boiling point, lower the flame so that it doesn't overflow. To avoid burns or damage to the hob, all recipients or griddle plates must be placed within the perimeter of the cooking hob. All containers have to have a flat and smooth bottom. When using fats or oils, be extremely careful that they don't overheat and catch fire.



If the flame accidentally goes out, turn off the control knob and wait at least 1 minute before trying to re-light the burner.



6.3 Diameter of containers (80 cm. models)

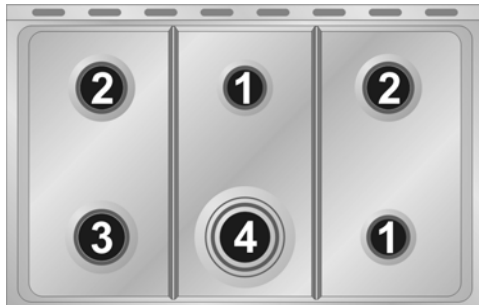
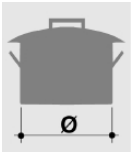

BURNERS

1. Auxiliary
2. Semirapid
3. Rapid
4. Triple crown

Ø min. e
max. (in
cm.)

12 – 14
16 – 22
18 – 24
18 – 26

6.4 Switching on the electric hob

6.4.1 Switching on the electric hobs

The cookers are equipped with hobs of different diameters. These are controlled by a switch and are turned on by turning the knob to the desired position. On the front panel above each knob a small drawing shows which hob corresponds to each knob. A yellow warning light lights up when the hob is switched on.

6.4.2 How to use the electric hobs

The rapid hobs offer the advantage of ultra-rapid cooking. Purely as an example the regulation table for the hobs is shown below.

RAPID HOBS	HEAT INTENSITY	POSSIBLE COOKING
0	Off	-
1	Weak	To melt butter, chocolate, etc. To heat small amounts of liquid.
2	Soft	To heat larger amounts of liquid.
3	Slow	To defrost frozen food and prepare stews, cooking at or just below boiling point.
4	Medium	To cook food which has to reach boiling point, to roast delicate meat or fish.
5	Strong	For roasts, steaks and large boiled joints.
6	Very strong	To boil large amounts of water, to fry.

WARNING

When switching on the hob for the first time, or if the hob has not been used for a long time, to remove any humidity from the insulating material it should be dried out by placing the hob on position 1 for 30 minutes.

To use correctly remember to:

- Switch the hob only after having placed the pan on it.
- Use flat and thick bottomed pans.
- Never use pans which are smaller than the hob.
- Dry the bottom of the pan before placing it on the hob.
- After use, to make sure that the surfaces are clean and long lasting, the electric hob must be treated with specific cleaning products which are available on the market. This necessary operation prevents oxidisation (rust formation).
- When cooking with flammable oils and fats, never leave the appliance.
- The hobs will stay hot for a long time after use: do not touch them or place any objects on them.
- Before switching on the electric hobs, lift up the glass cover on the cooker; before closing it, switch off the hobs and wait for them to cool down.
- If any dents appear in the hob surface, switch it off immediately and contact the nearest authorised servicing centre.

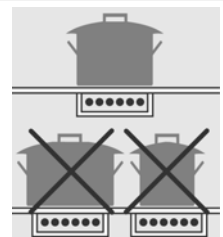





Instruction for the user

GB-IE

7 USE OF THE OVEN



For those models with electronic programmer, before using the oven make sure that the display shows the symbol .

For those models with analogue clock and timer, place on the symbol .

7.1 Warnings and general advice

Using the oven and the grill for the first time, heat them to the maximum temperature (**260°C** for electric oven and **275°C** for gas oven) for as long as it takes to burn off any production oil residues which could give a nasty flavour to the food. After a power cut, the oven display will flash intermittently and show **0:00**. To adjust refer to paragraph "8 ELECTRONIC PROGRAMMER (ONLY ON EQUIPPED MODELS)".



During cooking, do not cover the bottom of the oven with aluminium or tin foil and do not place pans or oven trays on it as this may damage the enamel coating. If you wish to use greaseproof paper, place it so that it will not interfere with the hot air circulation inside the oven.



The oven accessories which may come into contact with food are made from materials which conform to the standing directives.



WARNING: the gas oven is lit with the door open. The oven is equipped with a safety system which stops the burners being lit when the door is closed. If this is done wrongly, open the door and wait for a few moments before lighting once more.



To prevent any steam in the oven creating problems, open the door in two stages: half open (5 cm approx.) for 4-5 seconds and then fully open. To access food, always leave the door open as short a time as possible to prevent the temperature in the oven from falling and ruining the food.



7.2 Use of the gas oven

7.2.1 Electronic spark lighting

Open the oven door completely, press the thermostat knob and turn it clockwise to max. temperature. The electronic spark lighting device will be enabled automatically. Once the oven is lit, hold the knob down for a few seconds to allow the thermocouple to heat up.

This device should not be enabled for more than 15 seconds; if after this time the burner has not come on, stop, fully open the oven door and try again after one minute.



7.2.2 Manual lighting

Open the oven door completely and turn the thermostat knob. Place a lit match to the mouth of the flame pipe **A** in the centre of the oven floor and press the thermostat knob. Once the oven is lit, hold the knob down for a few seconds to allow the thermocouple to heat up and check that the oven is lit through the inspection hole **B**. Choose the cooking temperature by turning the knob clockwise to the desired temperature, between **50°** and **275°C**.

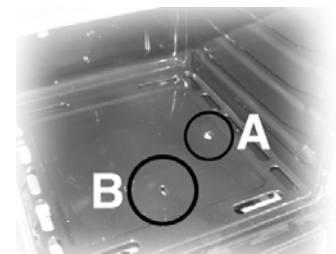

If the burner is accidentally switched off, turn the knob to the off position () and wait for one minute before lighting again.



7.3 Use of the gas grill

7.3.1 Manual lighting of the gas grill burner

Having opened the oven door, press the knob and turn it clockwise to the grill  position, placing a lit match to the burner on the roof of the oven.

Once the burner is lit, hold the knob down for about 10 seconds. If the burner does not stay lit after this time, release the knob and wait for at least one minute before trying again. If the burner accidentally goes out, turn the knob to the off position (●) and wait at least one minute before lighting again.

7.3.2 Electric lighting of the gas grill burner

Having opened the oven door, press the knob and turn it clockwise to the grill  position.

Once the burner is lit, hold the knob down for about 10 seconds. If the burner has not come on by this time, release the knob and wait for at least one minute before trying again. If the burner accidentally goes out, turn the knob to the off position (●) and wait at least one minute before lighting again.

During a power cut the burner can always be lit with a match.



CAUTION: IT IS NOT POSSIBLE TO OPERATE THE GAS OVEN AND THE GAS GRILL SIMULTANEOUSLY.

7.4 Use of the rotisserie

7.4.1 Using the rotisserie in cookers with maxi oven

Fit the supporting frame onto the second runner up from the bottom so that the seat to take the rod projects outside the oven. Place the rod as shown in the diagram (1) and push the frame into the oven until the end of the rod reaches the hole in the rotisserie motor. Now push the rotisserie rod to the left until it reaches the position shown in the diagram (2). To activate this function, turn the switch to (⚙).

These operations must be carried out with the oven switched off and cold.

When cooking is over, use the tool provided to extract the rod from the hole (3) and remove the frame (4) to bring the rotisserie rod out of the oven cavity.

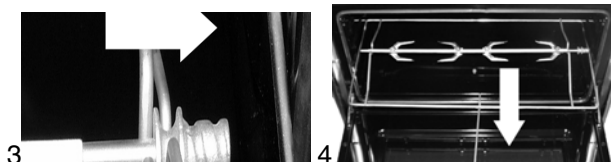
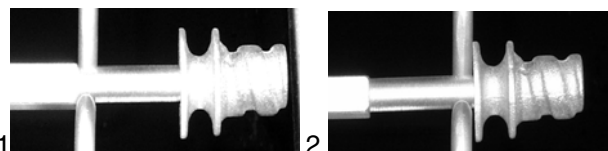

7.4.2 Using the rotisserie in cookers with standard ovens

Place the rotisserie frame "B" on the second runners up from the bottom and insert the rod "A" in the hole in the back of the oven.

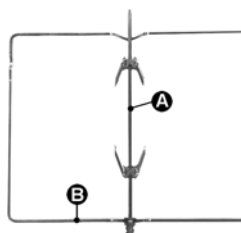



Instruction for the user

GB-IE

How to use the grill



Once the grill is lit, the red warning light will come on. Leave the oven to heat up for five minutes before placing the food inside.

Food should be flavoured and basted with oil or melted butter before cooking. An oven dish should be used to contain the sauces.

The food should be placed on the oven shelf which is positioned on one of the guides supplied with the different ovens, following the instructions below:

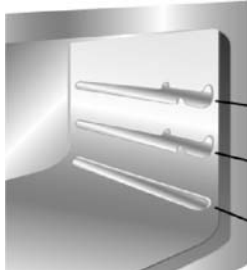

FOOD	GRILLE ON THE SHELF
Flat or thin meat	3
Rolled roast joints	2 – 3
Poultry	2 – 3

WARNINGS



- **Cooking procedures in this mode must never last more than 60 minutes.**
- **In models with gas oven, the door must be half-open on the first catch during grilling and grill-rotisserie cooking.**
- **In models with electric oven, the door must be close during grilling and grill-rotisserie cooking.**
- **To avoid dangerous overheating when the oven or the grill is used, the glass cover must always be up. The electric grill and the gas oven cannot be used at the same time.**
- **During and after use the accessible parts of the oven may be very hot, and children must always be kept at a distance.**
- **During cooking with the rotisserie, one of the oven trays provided with the cooker should be placed in the bottom of the oven, inserting it on the bottom runners, in order to collect the grease and fats which may be formed.**
- **When using the oven, remove all unused baking sheets and shelves from the interior.**

If your cooker is equipped with knob guard, when cooking using the grill or grill + rotisserie it must be fitted as shown here, fitting the slots "A" onto the pins "B" in the top of the oven.

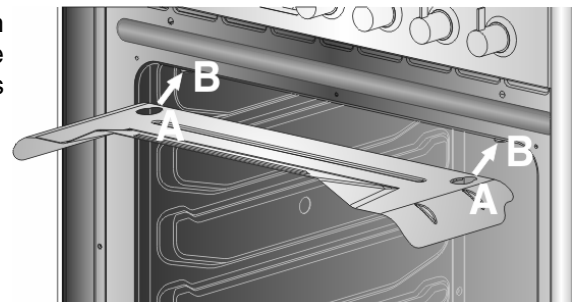

7.5 Storage compartment

A storage compartment, accessible by pulling on the top edge of the door, is located beneath the oven.

Never store flammable materials such as rags, paper or the like. The compartment is intended only for holding the metal accessories of the range.







Never open the storage compartment when the oven is on and still hot. The temperature inside may be very high.







8 ELECTRONIC PROGRAMMER (ONLY ON EQUIPPED MODELS)



LIST OF FUNCTIONS

	MINUTE-COUNTER KEY
	COOKING TIME KEY
	END-OF-COOKING KEY
	DECREASE TIME KEY
	INCREASE TIME KEY

8.1 Clock adjustment



When using the oven for the first time, or after a power failure, the display flashes regularly and indicates 0:00. Press the keys  and  and at the same time the keys  or : each single press changes the time by 1 minute either up or down.





Before setting the programmer activate the desired function and temperature.

8.2 Semiautomatic cooking

Use this setting for automatic oven switch-off at the end of cooking time.



By pressing key , the display lights up, showing 0:00; keep the key pressed and at the same time, press keys  or  to set the cooking time.





Release key  to start the programmed cooking time count. The display will now show the right time together with symbols **A** and .





8.3 Automatic cooking

Use this setting to automatically start and stop the oven.

By pressing key , the display lights up showing 0:00; keep the key pressed and at the same time, press keys  or  to set the cooking time.

By pressing key  the sum of the right time + cooking time will appear; keep the key pressed and at the same time, press keys  or  to regulate the end of cooking time. Release key  to start the programmed count and the display will show the right time together with symbols **A** and .



After set-up, to see the cooking time remaining, press the key ; to see the end of cooking time press the key . Set-up with incoherent values is logically prevented (e.g. the contrast between a cooking time and a longer period will not be accepted by the programmer).



Instruction for the user

GB-IE

8.4 End of cooking



When cooking is over, the oven will automatically switch off and, at the same time, an intermittent alarm will sound. After switching off the alarm, the display will once again show the right time together with the symbol , indicating that the oven has returned to manual operation mode.









8.5 Adjusting alarm volume

The acoustic alarm has three different settings. These can be operated, while the alarm is sounding, by pressing key .

8.6 Switching off the alarm

The alarm switches off automatically after seven minutes. They can be manually de-activated by pressing the keys  and  together.



8.7 Minute Counter

The programmer can also be used as a simple minute counter. By pressing key , the display shows ; keep the key pressed and at the same time press keys  or . On releasing the key , programmed counting will begin and the display will show the current time and the symbol .





After set-up, to see the remaining time, press the key . Use as a minute counter does not interrupt functioning of the oven at the end of the programmed time.

8.8 Cancellation of set data

Once the programme has been set, keep the key of the function to be cancelled pressed, while at the same time  is reached by means of variation keys  or . Time cancellation will be considered as end-of-cooking time by the programmer.

8.9 Changing the set data

The cooking data entered can be changed at any time by keeping the function key pressed and at the same time adjusting the keys  or .





9 DIGITAL TIMER (CERTAIN MODELS ONLY)



This component allows an on-off beeper to be set to indicate the end of the cooking time. It is therefore just a timer, with no programming functions.





LIST OF FUNCTIONS



-  TIME-SETTING BUTTON
-  VALUE DECREASE BUTTON
-  VALUE INCREASE BUTTON

9.1.1 Setting the time

When the oven is used for the first time, or after a power blackout, the display flashes on and off at regular intervals showing 0:00. Press the  key and use the  or  keys to set the current time.

9.1.2 Setting the timer

To set the timer, press the  key and keep it pressed until the required number of minutes is shown. When the  key is released, after 5 seconds the countdown will start; once this finishes, an acoustic device will sound.

During the countdown the display will show the  symbol; pressing the  key displays the current time for 5 seconds.

9.1.3 Deactivating the acoustic device

The acoustic device stops sounding automatically after seven minutes. It can be deactivated in manual mode by pressing the  key.

9.1.4 Adjusting the volume of the acoustic device

The volume can be adjusted (3 settings) while it is in operation by pressing the  key.

9.1.5 Modifying the data set

The timer data set can be modified at any moment by pressing the  or  keys.

10 ANALOGUE CLOCK (ONLY ON EQUIPPED MODELS)

The mechanical timer is set by turning the knob clockwise.

The timer can be set from 0 to 55 minutes. At the end of the cooking time, an alarm signal will be heard: to stop the alarm turn the external part of the knob to position .

The clock is set by pulling the knob and turning it clockwise.





Instruction for the user

GB-IE

11 CLEANING AND MAINTENANCE

11.1 Cleaning stainless steel and enamelled versions



To maintain stainless steel in good condition it must be cleaned regularly after each use, once it has cooled down.

11.1.1 Ordinary Daily Cleaning

To clean and preserve the stainless steel surfaces, always use **only** specific products that do not contain abrasives or chlorine-based acids.

How to use: pour the product on a damp cloth and wipe the surface, rinse thoroughly and dry with a soft cloth or deerskin.

11.1.2 Food stains or residues

Do not use metallic sponges or sharp scrapers: they will damage the surface.

Use normal non-abrasive products for steel, and a wooden or plastic tool if necessary.

Rinse thoroughly and dry with a soft cloth or deerskin.

Do not allow residues of sugary foods (such as jam) to set inside the oven. If left to set for too long, they might damage the enamel lining of the oven.



11.2 Cleaning of cooking hob components

11.2.1 The glass cover

The cover can be removed from the hinges by lifting it upwards when it is open. This makes cleaning easier.



If liquids are spilt on the closed lid, remove them thoroughly with a rag before opening it.

11.2.2 Grids

Remove the grids and clean them in warm water with a non-abrasive detergent, taking care to remove any incrustations. Replace them on the cooking hob.

Continuous contact of the grids with the flame can cause the paint near the hot areas to be altered. This is completely natural and does not compromise the functionality of the component.

11.2.3 Burner caps and flame cap crowns

The caps and flame-spreader crowns are extractable to facilitate cleaning. Wash them in hot water with non-abrasive detergent, taking care to remove any incrustations, and wait until they are **perfectly dry**.



CAUTION: do not wash these components in a dishwasher. The burners can be left to soak in hot water and detergent.

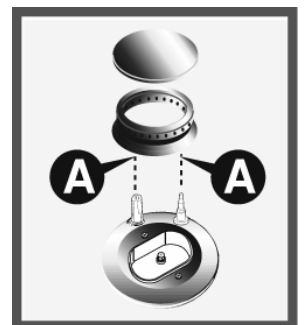

Replace the flame-spreader crowns, checking that they are positioned in their housing with their respective caps, taking care that flame-spreader holes **A** correspond to the spark plugs and the thermocouples.

Instruction for the user



11.2.4 The spark plugs and thermocouples

To function properly the spark plugs and thermocouples must always be clean (on the models which are equipped with them). Check them regularly and clean with a damp cloth if necessary. Any dry residues can be removed with a toothpick or a needle.

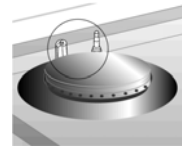

11.3 Cleaning of oven



For best oven upkeep clean regularly after having allowed to cool. Take out all removable parts.

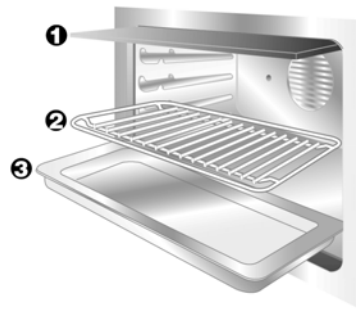
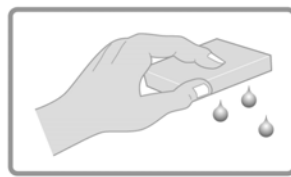

- Clean the oven grill with hot water and non-abrasive detergent. Rinse and dry.
- Clean the internal walls of the oven with a soft ammoniac-soaked cloth. Rinse and dry. If there are still stains or drops, place a damp ammoniac-soaked cloth on the bottom of the oven, close the door and after a few hours wash the oven with hot water and liquid detergent. Rinse and dry.

11.4 Door glass

The door glass should always be kept clean. Use absorbent kitchen paper to clean. In case of tough spots, clean with a damp sponge using regular detergent.



Instruction for the user

GB-IE

12 EXTRAORDINARY MAINTENANCE

The oven may require extraordinary maintenance or replacement of parts subject to wear such as seals, bulbs, and so on. The following instructions describe how to carry out these minor maintenance operations.



Before any intervention, disconnect the power supply of the device.

12.1 Lubrication of the taps and gas oven thermostat



In time the taps and gas oven thermostat may be difficult to turn or may be blocked. Clean them inside and replace the lubrication grease. **This operation should be carried out by a specialised technician.**

12.2 Replacement of light bulb

Remove cover **A** by twisting anticlockwise, replace bulb **B** with another similar bulb (25 W). Refit the cover **A**.

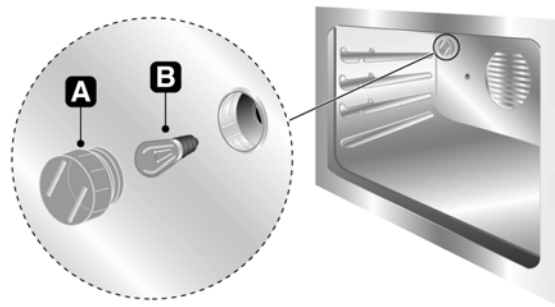

Only use oven bulbs (T 300°C).

12.3 Removing the door

Raise levers **B** and hold the door on both sides with both hands near hinges **A** and. Lift up the door forming an angle of about 45° and remove. To refit, slide the hinges **A** in the grooves, drop the door and release levers **B**.

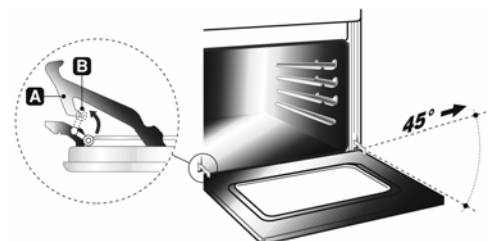

12.4 Oven door seal

To permit thorough cleaning of the oven, the seal may be removed. Before removing the seal, take off the door as described above. Once the door has been taken off, lift the tabs at the corners as shown in the figure.

