



User's Manual

5,850 BTU Room Air Conditioner
Model: SCA062RWB1



Table of Contents

	Page
Introduction	2
Parts Identification	2
Electrical Specifications	4
Tips Before Installation	5
Installation Instructions	6
Operating Instructions	9
Care and Maintenance	13
Troubleshooting Guide	14

Introduction

Thank you for choosing this room air conditioner to cool your home. This USE AND CARE MANUAL provides information necessary for the proper care and maintenance of your new room air conditioner. If properly maintained, your air conditioner will give you many years of trouble free operation. To avoid installation difficulties, read instructions completely before starting. This manual contains information for the installation and operation of your room air conditioner.

Part Identification

► Mechanical control model

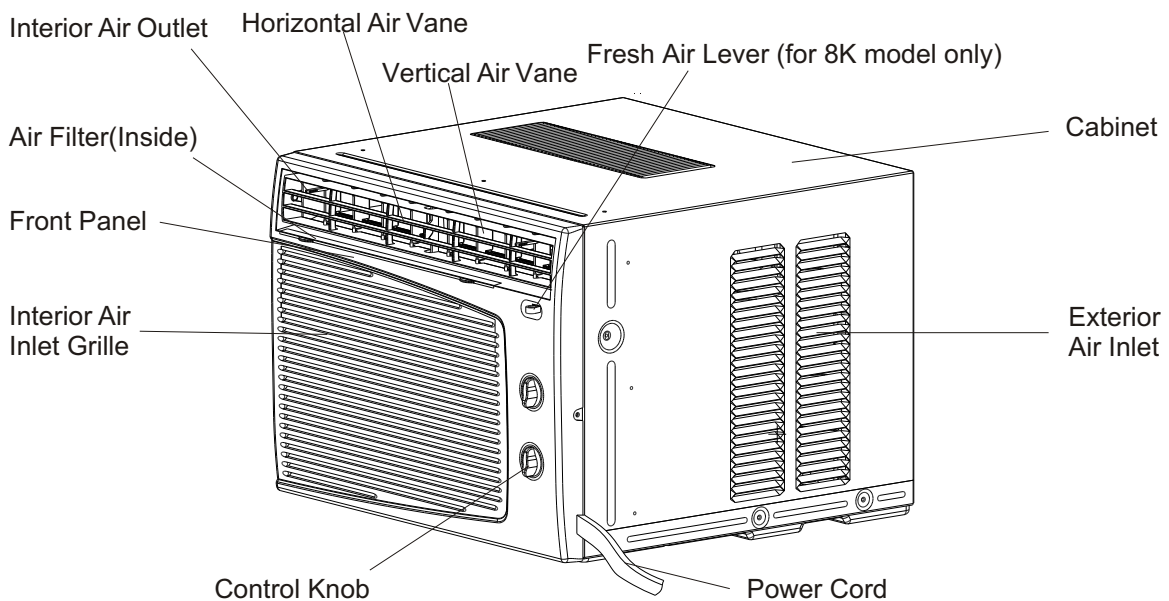

Note:

The figures in this manual are based on the external view of a standard model. Consequently, the shape may differ from that of the air conditioner you have selected.

Introduction

Part Identification

► Remote control model

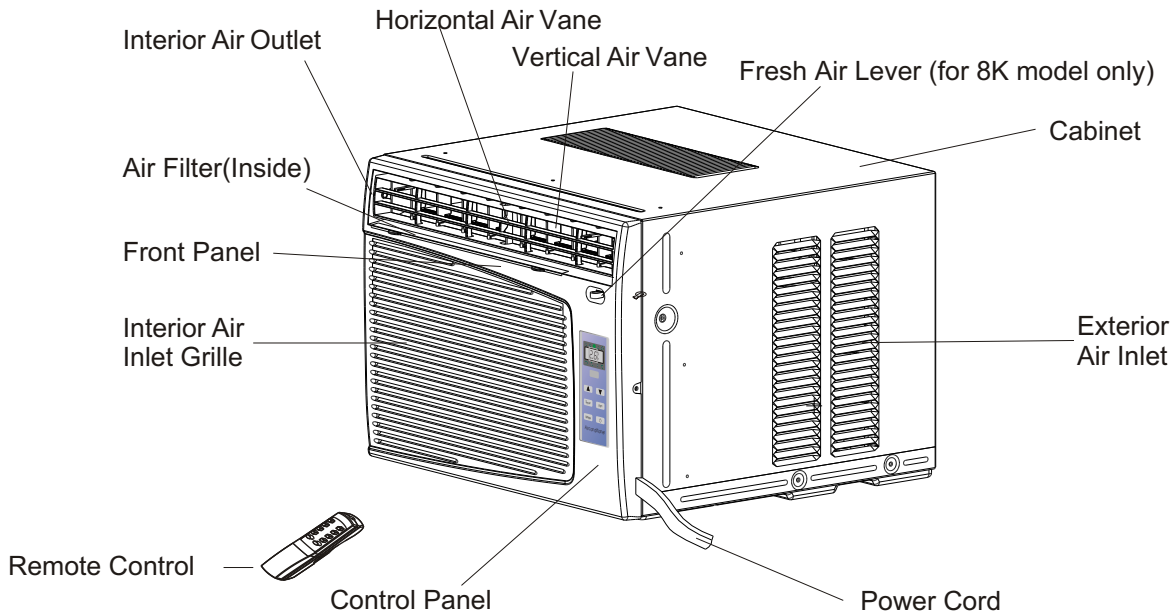

Control Panel

Remote Control

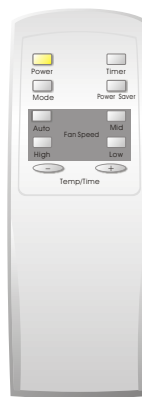

Note:

The figures in this manual are based on the external view of a standard model. Consequently, the shape may differ from that of the air conditioner you have selected.

Electrical specifications

1. All wiring must comply with local and national electrical codes and must be installed by a licensed electrician. Once you have any questions regarding the following instructions, contact a licensed electrician.
2. Check available power supply and resolve any wiring problems **BEFORE** installing and operating this unit.
3. For your safety and protection, this unit is grounded through the power cord when plugged into a matching wall outlet. **If you are not sure whether your wall outlet is properly grounded, please consult a licensed electrician.**
4. The wall outlet(3-pin) must match the plug (3-pin) on the power cord supplied with the unit. DO NOT use plug adapters or extension cords. See (Table 1) for receptacle and fuse information.

Electric Shock Hazard

If the air conditioner has a serial plate rating of 115 volts and up to and including 7.5 amps the unit maybe on a fuse or circuit breaker with other devices. However, the maximum amps of all devices on that fuse or circuit breaker can not exceed the amps of the fuse of circuit breaker.

If the air conditioner has a serial plate rating of 115 volts and greater than 7.5 amps it must have its own fuse or circuit breaker, and no other device or unit should be operated on the fuse or circuit breaker.

To avoid the possibility of personal injury, disconnect the power to the unit before installing or servicing.

5. The rating plate on the unit contains electrical and other technical data. The rating plate is located on the right side of the unit.

RECEPTACLE AND FUSE TYPES	
COOLING CAPACITY	5K、6K、8K
RATED VOLTS	125
AMPS	15
WALL OUTLET	
FUSE SIZE	15
Time Delay Fuse (or circuit breaker)	Plug type

Table 1

Tips before installation

Your Room Air Conditioner unit is designed to be highly efficient and save energy. Follow these recommendations for greater efficiency.

1. Select thermostat setting that suits your comfort needs and leave the thermostat at that chosen setting.
2. The air filter is very efficient in removing airborne particles. Keep the air filter clean. Typically, filter should be cleaned once a month. More frequent cleaning may be necessary depending on outdoor and indoor air quality.
3. Use drapes, curtains, or shades to keep direct sunlight from heating your room, but **DO NOT** obstruct the air conditioner. Allow air to circulate around the unit without obstructions.
4. Start your air conditioner before outdoor air becomes hot and uncomfortable. This avoids an initial period of discomfort while the unit is cooling off the room.
5. When outdoor temperature is cool enough, use **HIGH** or **LOW FAN** only. This circulates indoor air, providing some cooling comfort, and utilizes less electricity than when operating on a cooling setting.

Your Room Air Conditioner was designed for easy installation in a single or double-hung window. **NOTE:** This unit is **NOT** designed for vertical (slider type) windows.

⚠ CAUTION ⚠
To avoid installation/operating difficulties, read the instructions thoroughly.

NOTE: Save the shipping carton and packing materials for future storage or transport of the unit. Please check the contents of the hardware kit against the corresponding model check list, prior to installation of the unit. See lists below. (Fig. 1)









Installation Hardware	
 3/4" Screws (12)	 Seal(1)
 2/5" Screws (8)	 Foam(1)
 Top Channel(1) <i>factory installed</i>	Side Curtain RH(1) Side Curtain LH(1)
 L Bracket(2)	
 Side Bracket(2)	

Fig. 1

NOTE: Surplus screw(s) for spare use.

Tools Needed for Window Installation
 Screw drivers: Both Philips and flat head
 Power drill: 1/8 inch diameter drill bit
 Pencil
 Measuring tape
 Scissors
 Carpenters level

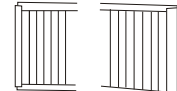
Installation instructions

⚠ CAUTION ⚠

Because the compressor is located on the controls side of the unit (right side), this side will be heavier and more awkward to manipulate. Inadequate support on control side of the unit can result in personal injury and damage to your unit and property. Therefore, it is recommended to have someone assist you during the installation of this unit.

F. Your unit was designed to evaporate condensation under normal conditions. However, under extreme humidity conditions, excess condensation may cause the base pan to overflow to the outside. The unit should be installed where condensation run-off cannot drip on pedestrians or neighboring properties.

1. Select the Best Location

A. Your room air conditioner was designed to fit easily into a single or double hung window. However, since window designs vary, it may be necessary to make some modifications for safe and proper installation.

B. Make sure the window and frame are structurally sound and free from dry and rotted wood.

C. For maximum efficiency, install the air conditioner on side of the house or building which favors more shade than sunlight. If the unit is in direct sunlight, it is advisable to provide an awning over the unit.

D. Provide sufficient clearance around the cabinet to allow for ample air circulation through the unit. See (Fig.2). The rear of the unit should be outdoors and not in a garage nor inside of a building. Keep unit as far away as possible from obstacles and obstructions and at least 30" above the floor or ground. Curtains and other objects within a room should be prevented from blocking the air flow.

E. Be certain the proper electrical outlet is within reach of the installation. Use only a single outlet circuit rated at 15 amps. All wiring should be in accordance with local and national electrical codes.

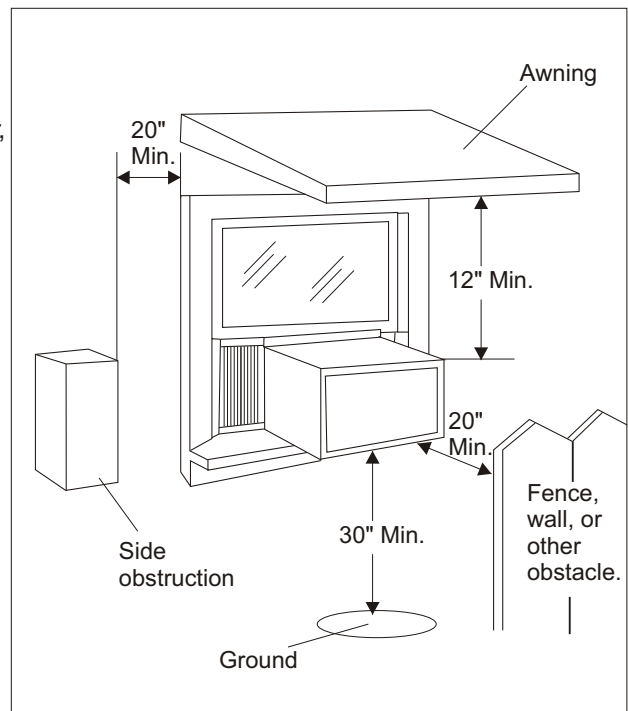

Fig.2

Window opening requirements (see table below)

Size	Model	5K-6K	8K
Cabinet size (W*H*D)		17.7" *12.4" *15.7"	18.5" *13.7" *17.7"
Min. Window opening		21"	22"
Max. Window opening		35"	36"

Installation instructions

Window installation step

1. If your air conditioner cabinet 18" wide, it will fit window openings 21" to 32" in wide. Minimum opening height is 14" from bottom of sash to sill (Fig. 1).

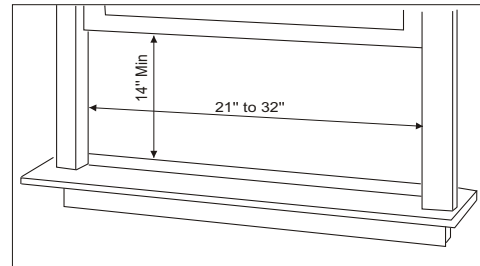

Fig. 1

2. Insert the guide panels into the guides of the air conditioner. Fasten the curtains to the unit with screws (Fig. 2).

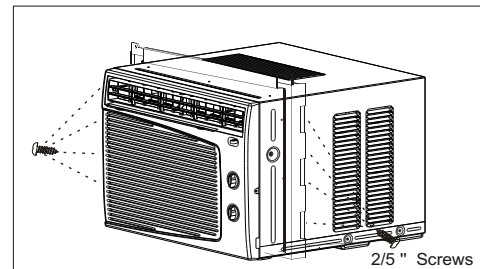

Fig. 2

3. Cut the adhesive-backed seal strip the window width. Remove the backing from the seal strip and attach the seal strip to the underside of the bottom window. (Fig. 3)

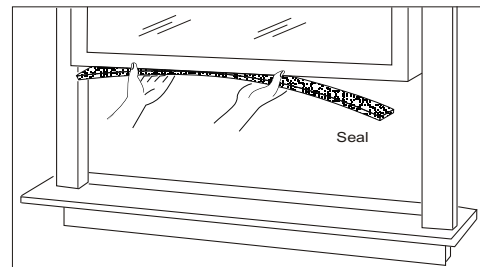

Fig. 3

4. Measure the inside window sill width and find the center line as shown in Fig. 4.

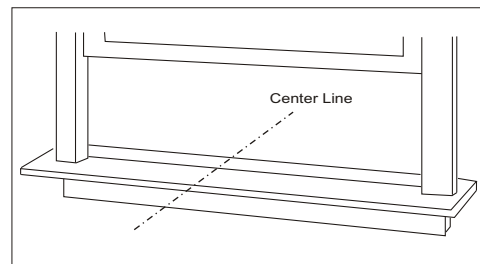

Fig. 4

Installation instructions

5. Install the L brackets on the outer sill with the short side of the bracket against the back of the inner sill. Install one L bracket 7.5" to each side of center line. See Fig. 5.

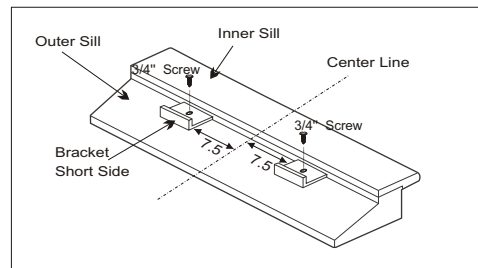

Fig. 5

6. Carefully lift the air conditioner and slide it into the open window. Make sure the bottom guide of the air conditioner drops into the notches of the L brackets. When the air conditioner drops into the L brackets, the air conditioner will be centered in window opening as show in Fig. 6.

While steadying the air conditioner, carefully bring the window sash down behind the top channel of the air conditioner, as shown in Fig. 7.

First, fix both sides onto the window sill with two 3/4" screws and one 2/5" screw (which is unscrewed from each side of the unit). Then fix top channel to widow sash with one 3/4" screw and fix side curtain frames with four 3/4" screws as shown in Fig.6.

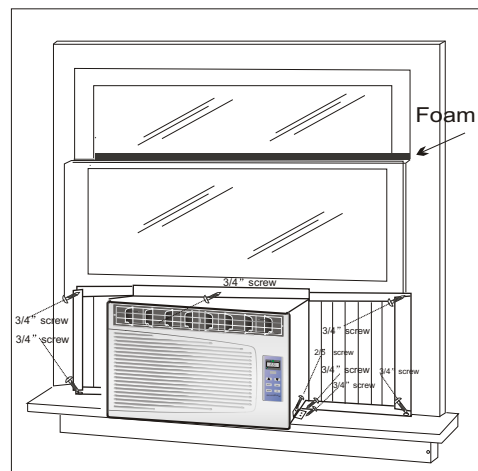

Fig. 6

7. If storm window presents interference, fasten a 2" wide wood strip to the inner window sill across the full width of the sill. The wood strip should be thick enough to raise the height of the window sill so that the unit can be installed without interference from the storm window frame, as show in Fig. 8.

Top of wood strip should be approximately 3/4" higher than the storm window frame to help condensation to drain properly to the outside.

Install a second wood strip (approximately 6" long by 1 1/2"wide and same thickness as first strip) in the center of the outer sill flush against the back of the inner sill.

Screw the L brackets into this strip.

This will raise the L bracket as shown in Fig. 8.

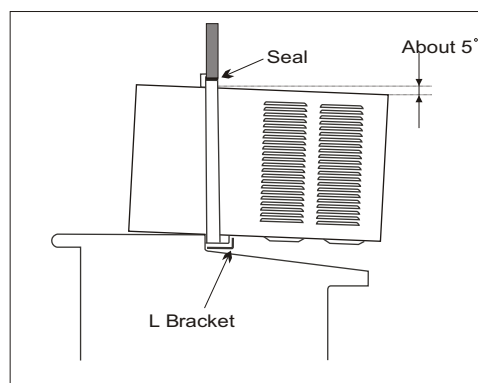

Fig.7

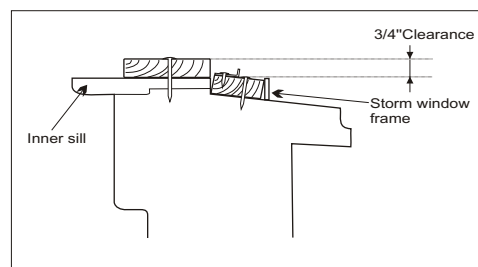

Fig.8

Operating Instructions

► Mechanical control model

MODE

The mode knob controls fan speeds and cooling speeds. To set desired cooling temperature, simply rotate the mode knob dial to the appropriate setting. See Fig. 9.

THERMOSTAT

The thermostat automatically controls the cooling cycle (compressor) of the air conditioner to maintain room temperature. However, the fan motor will continue to operate after the compressor (cooling cycle) is completed. See Fig.9.

LOW FAN will circulate the air at a minimum speed without cooling.

HIGH FAN will circulate the air at a maximum speed without cooling.

LOW COOL provides cooling, automatically with minimum air circulation. Recommended for night-time use.

HIGH COOL provides cooling, automatically with quick cooling or for extremely hot days. Once room is cooled, reduce setting to **LOW COOL**.

OFF will completely shut-off the unit.

NOTE: After setting the mode, allow 3 minutes before switching to another mode.

Fresh Air Ventilation is usually kept in the closed position. Use only when clearing smoke and/or odors from the room. Pull to open. (See Fig.10).

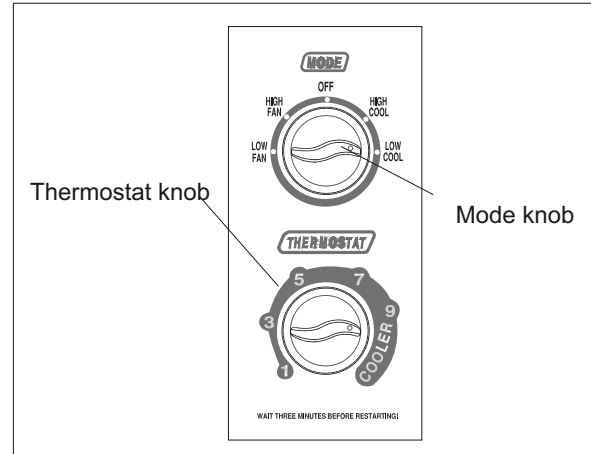

Fig.9



CAUTION



When using FAN control, turn slowly allowing unit to adjust.

When using **THERMOSTAT**, be sure to allow three minutes before changing temperature. Adjusting too quickly may cause an overload resulting in a blown fuse.

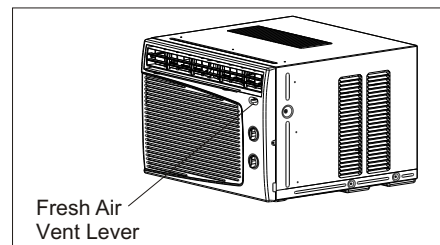

Fig.10

Operating Instructions

► Control Panel

You can easily operate this air conditioner by pressing relevant button on the control panel as well as the remote control.

⏻ Button

The air conditioner will be started when it is energized or will be stopped when it is in operation, if you press this button. When the air conditioner is heating, allow 3 minutes after you press this button.

Mode button

Each time Mode button is pressed, the operation mode is changed in sequence:

5K、6K、8K cooling only: COOLING→FAN ONLY

→ENERGY SAVING →COOLING

8K with heater : COOLING→FAN ONLY→HEATING

→ENERGY SAVING→COOLING

NOTE: After setting the mode, allow 3 minutes before switching to another mode.

In the FAN ONLY Mode , Room Temperature display range is from 0°C(32°F) to 38°C(99°F).

Room Temperature below 32°F,the Temperature display L0.

Room Temperature above 99°F,the Temperature display H1.

Fan Speed button

Used to select fan speed in sequence auto, low, medium and high (low and medium are in same fan speed).

Timer button

Used to set or cancel timer operation.

When the unit is in operation, you can set OFF TIMER.

When the unit is off, you can set ON TIMER.

Timer setting range is 0 to 24 hours.

If the OFF TIMER is set, the timer LED displays the remaining time to turn off the unit for only 12 seconds, then LED shifts to display set temperature. If you press TIMER button within the 12 seconds, OFF TIMER will be canceled.

If the ON TIMER is set, the timer LED displays the remaining time to turn on the unit. If you want to cancel ON TIMER, press TIMER button.

▲ ▼ Button

Used to set room temperature in COOLING mode or used to set time in TIMER mode.

If the two keys are pressed at the same time, the temperature LED display will alternate between °C and °F.

NOTE: Temperature setting range is from 19°C(66°F) to 31°C(88°F).

Control Panel



Indication symbols of LED on control panel :

- | | |
|------------------|---------------|
| Auto fan speed | Cooling |
| Low fan speed | Fan only |
| Medium fan speed | Heating |
| High fan speed | Energy-saving |
| | Timer |

Display set temp
Display set timer

Above LED lights on when the relevant mode is in used.

Operating Instructions

Remote control

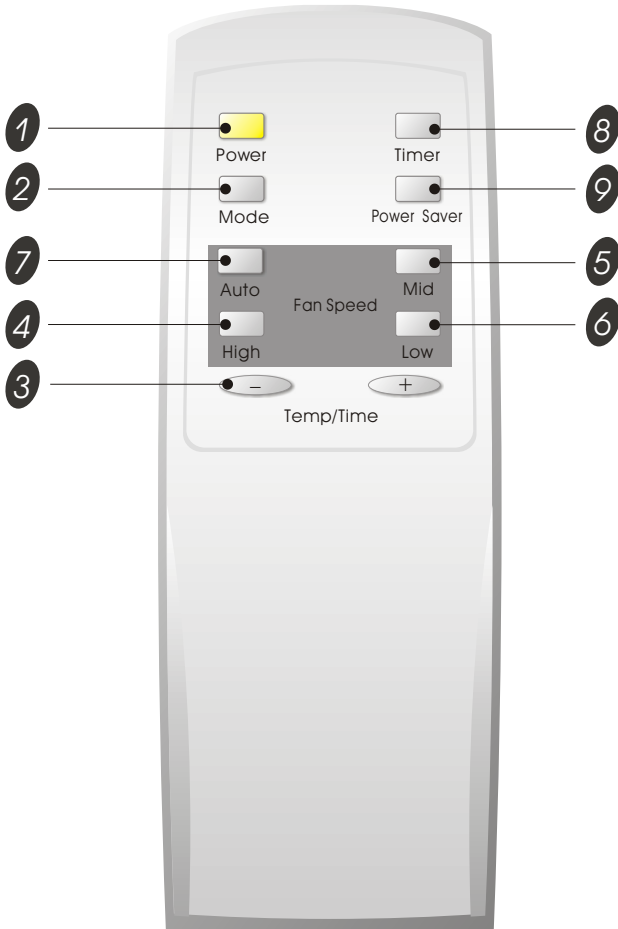

1 Power BUTTON

The appliance will be started when it is energized or will be stopped when it is in operation, if you press this button.

2 Mode BUTTON

Used to select the operation mode.

3 + - BUTTONS

Used to set room temperature in COOLING mode or used to set time in Timer mode.

4 High BUTTON

Used to select the high fan speed mode.

5 Mid BUTTON

Used to select the mid (same as low) fan speed mode.

6 Low BUTTON

Used to select the low fan speed mode.

7 Auto BUTTON

Used to select the auto fan speed mode.

8 Timer BUTTON

Used to set or cancel timer operation.

9 Power Saver BUTTON

Used to select the Energy-saving mode.

- ☑ • When changing modes during operation, sometimes the unit does not always response at once. Wait 3 minutes.
- Wait 3 minutes before restarting the appliance.

Operating Instructions

Remote control

• How to Insert the Batteries

Remove the battery cover according to the arrow direction.

Insert new batteries making sure that the (+) and (-) of battery are matched correctly.

Reattach the cover by sliding it back into position.

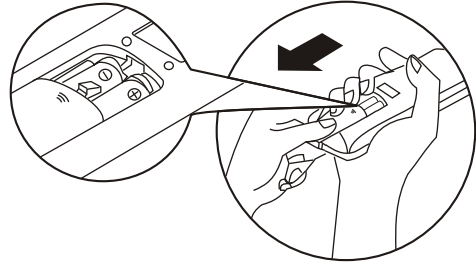

Note:

- Use 2 LR6 AA(1.5volt) batteries. Do not use rechargeable batteries. Replace batteries with new ones of the same type when the display becomes dim.
- If the replacement is done within 1 minute, the remote control will keep original presetting. (This function only for LCD remote control)

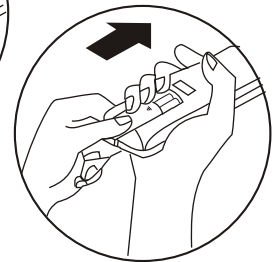
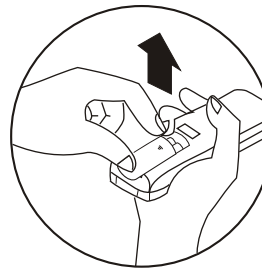

• How to Use

To operate the room air conditioner, aim the remote control to the signal receptor.

The remote control will operate the air conditioner at a distance of up to 23 feet when pointing at signal receptor of indoor unit.

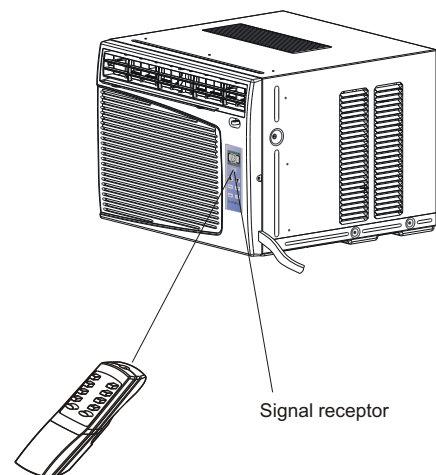

Care and Maintenance

When servicing the air conditioner, be sure to turn the mode switch to the "OFF" position and disconnect the power cord from the electrical outlet.

1. **DO NOT** use gasoline, benzine, thinner or other chemicals on the air conditioner as these substances may cause damage to the paint finish and deformation of plastic parts.
2. Never attempt to pour water directly in front of the unit as this will cause deterioration of the electrical insulation.

Cleaning the Air Filter

If the air filter becomes clogged with dust, air-flow is obstructed and reduces efficiency. The air filter should be cleaned once a month. More frequent cleaning may be necessary depending on outdoor and indoor air quality.

Air Filter Removal

The air filter on the above models is located behind the air intake front grill.

To remove the air filter, grasp the filter handle(tab) located on the up (center) side of the air inlet grille and slide the air filter to the up.

To reinstall the air filter, reverse the above procedure.

CAUTION	
<p>DO NOT forget to install the air filter. If the air conditioner is left to operate without the air filter, dust is not removed from the room and may cause your air conditioner to fail.</p> <p>When the air filter inlet grill and cabinet are dirty, wipe with lukewarm water (below 104 °F). Use of mild detergent is recommended.</p>	

Cleaning of Air Filter

1. Remove dust clogged in the filter by tapping it or vacuum clean it.
2. Wash the filter well with lukewarm water below 40°C (104 °F) while rubbing lightly. To get better results, wash it with soapy water or a neutral cleaning agent.
3. Rinse the filter well using clean water then dry completely.

End-of-Season Care

1. Operate the fan alone for half a day to dry out the inside of the unit.
2. Turn off power and remove plug from wall socket.
3. Clean filter.
4. Store in a dry location.

Troubleshooting Guide

Frequently, a problem is minor and a service call may not be necessary, use this troubleshooting guide for a possible solution.

PROBLEM	POSSIBLE CAUSE	SUGGESTED SOLUTION
Air conditioner will not operate	No power to the unit.	Check connection of power cord to power source. Check fuse or circuit breaker. Set MODE knob to position other than "OFF".
Inefficient or no cooling	Dirty air filter. Inappropriate capacity for application. Blocked air flow. Power interruption, settings change too quickly, or compressor overload tripped.	Clean or replace air filter. Check with dealer to determine proper unit capacity for application. Remove obstruction from grill or outdoor louvers. Let fan run to restart compressor (in approximately 10 minutes).
Noisy unit	Loose parts. Inadequate support.	Tighten loose parts. Provide additional support to unit.
Odors	Formation of mold, mildew, or algae on wet surfaces.	Remove drain plug and drain base pan. Replace drain plug. Clean unit thoroughly.
Water dripping outside	Condensation run-off is normal during hot and humid weather	Add flexible tubing to redirect water flow.
Water dripping inside	Unit is not properly angled to allow water to drain outside.	Unit must be installed on an angle for proper condensation run-off. Check the unit and make adjustments.
Ice or frost build-up	Low outside temperature. Unit air filter is dirty.	When outdoor temperature is approximately 65°F or below, frost may form when unit is in cooling mode. Switch unit to FAN (only) operation until frost melts. Remove and clean filter.

NOTE:

If circuit breaker is tripped repeatedly, or fuse is blown more than once, contact a licensed technician.

Sunbeam[®]

© 2006 Sunbeam Products, Inc. doing business as Jarden Consumer Solutions. All rights reserved. Sunbeam[®] is a registered trademark of Sunbeam Products, Inc. used under license. Distributed by Petters Consumer Brands, LLC. 4400 Baker Road, Minnetonka, MN 55343.

For service, support and warranty information, visit www.sunbeammajorappliances.com or in the US call 1-866-866-6283.