



CinemaLift™ for Apple Cinema Displays®
StudioLift™ for Apple Cinema Displays®



Installation Instructions

Ergonomic mounting solutions for monitors and keyboards

Table of Contents:

*These instructions are applicable for Models 3500, 3545, 7000, 7045 and 7506; all which include the FLEXmount™

1.	Hardware Parts List	
	A. Arm	Page 2
	B. FLEXmount™	Page 3
2.	FLEXmount™ Set-up Options	
	A. Desk Edge Clamp	Page 4
	B. Through Desk	Page 5
	C. Wall Mount/Reverse Wall Mount	Page 5
	D. Special Mounting Scenarios	Page 6
3.	Bracket Assembly	Page 7
4.	Arm Assembly	Page 8
5.	Cable Management	Page 9
6.	Adjusting your Monitor Arm	Page 10

How to place an order:

telephone
800.524.2744













email
sales@LCDarms.com

fax
610.253.9521











Order online at:
www.LCDarms.com

Helpful handy information:

- ▲ Product Number
- ▲ Does your LCD meet the VESA standard? Not sure? Check out www.LCDarms.com/adapter
- ▲ Monitor Weight
- ▲ Mount type if not included

Item	Description & Part No.	Quantity
	10-32 x 3/8" Phillips Flat Head Screw 705198	1
	Dog Washer 105189	1
	10-32 x 3/8" Phillips Flat Head Screw 702281	1 (4-pack)
	M3-16 Socket Head Screw 702038	3
	M3 Steel Nut 702161	3
	M3 Wrench DX2013	1
	M2 Allen Wrench 702040	1
	M2.5 Allen Wrench 702218	1
	Cable Trough 702830	1
	Forearm Cap 702825	1
	Endcap Bumper 702829	1
	Cable Clip DX1835	1

*Depending on the mount style you select, you will not use all of the parts listed below.

Item	Description & Part No.	Quantity
	Mount Column 702831	1
	Base Plate 702826	1
	Large "L" Bracket 702828	1
	Small "L" Bracket 701116	1
	3" x 3/4" x 1/4" Rectangular Spacer 701544	1
	3/8-16 x 1 1/4" Flat Socket Cap Screw 701799	1
	3/8-16 x 7/8" Button Socket Cap Screw 701122	1
	3/8-16 Nylon Stop Nut 701418	1
	3/8-16 x 7/8" Flat Socket Cap Screw 701124	1
	3/8-16 x 2 1/2" Hex Head Bolt 700268	1
	1/2-13 x 3" Socket Set Screw 701126	1

Desk Edge Clamp Mount



Step 1

Drop the nylon stop nut into the impression on the inside of the metal mount column. The rounded top of the nylon stop nut should be facing upwards.



Step 2

Position the mount cup, base plate and the large "L" bracket so that the center holes are aligned as shown in the picture on the left.

To screw the three parts together use the 3/8-16 x 1" flat head socket cap screw and the 7/32" allen wrench. Insert the 3/8-16 x 1" screw through the counter sunk hole in the large "L" bracket so that it engages the nylon stop nut. Tighten with the 7/32" allen wrench. The assembly is secure when the 3/8" screw no longer turns.



Step 3

Align the small "L" bracket with the holes on the side of the large "L" and attach with 3/8-16 x 7/8" Flat Head Socket Cap Screw.



Step 4

Line up the center hole on the spacer with the hole in the small "L" bracket; insert the male end of the 3" screw and begin turning it until the spacer touches the bottom of the surface of the desk.

Through-Desk Mount

Step 1

Drill a hole 3/8" into desk or mounting surface about 1 1/2"-2" in from the edge of the surface edge.

Step 2

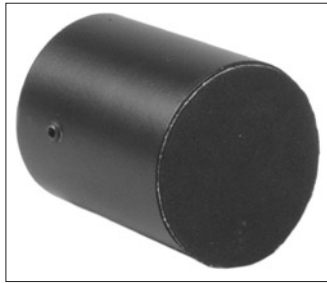

Remove the backing on the Neoprene foam pad and affix to the bottom of the mount cup. (ONLY if you will not be using the baseplate set-up in the next step)

Step 3

Line up the mount cup over the hole and drop the 2.5" threaded bolt into the mount cup, through the optional base plate and through the desk.



Step 4



Under the desk, slide the rectangular spacer onto the 3/8-16 x 2 1/2" Hex Head Bolt. Attach the nut to the bolt and tighten until the mount is secured to the desk.

NOTE: The rounded part of the nut should be facing downward.

Wall/Reverse Wall Mount

Wall mounting hardware is not provided.

Step 1

Secure the large "L" bracket to a stud in the wall using wood screws.

Reverse Wall Mount: Follow Step 1 above; be sure the short side of the "L" bracket is on top.

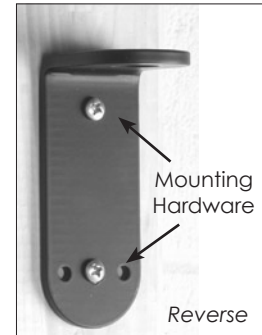

Step 2



Drop the nylon stop nut into the impression inside the mount cup.

The rounded top of the nylon stop nut should be facing upward.

Step 3

Align the mount cup over the short end of the large "L" bracket so you can screw the two components together using the 3/8-16 x 7/8" Button Head Socket Cap screw and tighten using the 7/32" allen wrench. The mount is secure when the 3/8" screw no longer turns.

If you are using the Reverse Mount configuration, the 3/8-16 x 1 1/4" Flat Socket Cap Screw should be used.



Special Mounting Scenarios

Some desks have thick edges as well as trim that extends below the work surface. The FLEXmount™ was designed to accommodate any challenging mounting surface.



Thick desk edge

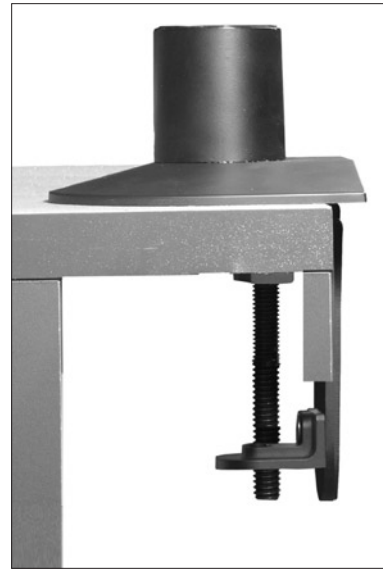

Desk with longer trim



Desk without an edge



Desk with a small lip

Before beginning the assembly of your arm, be sure to select a secure mounting surface by configuring your FLEXmount™

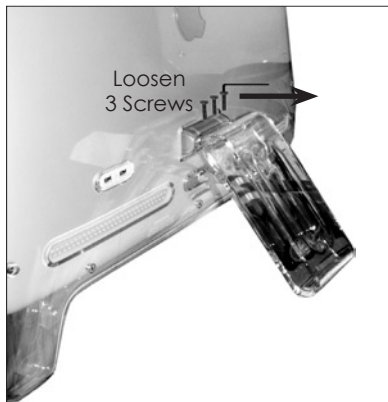

Step 1

Carefully remove the stand from the monitor by loosening the 3 screws using the M2 allen wrench. Slide the stand off of the monitor toward you.

Step 2

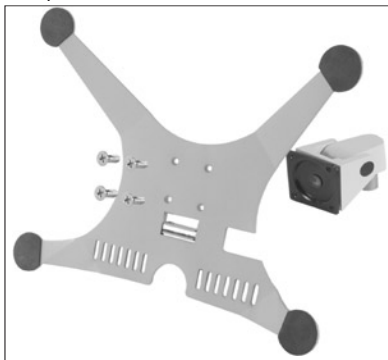

Attach the tilt mechanism to the adapter plate using four (4) #10-32 x 3/8" Flat Head Philips Pan screws.

Step 3



Align the filter and apple adapter bracket with the extrusion on the back of the monitor; sliding it into the slot on the bracket.



Step 4

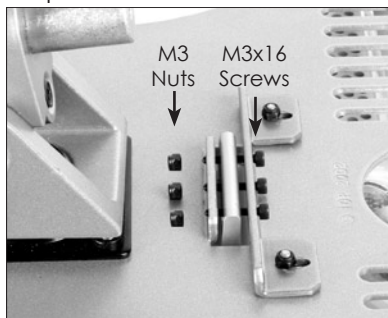

Attach the Apple bracket to the monitor using the (3) M3 x 16 Socket Head Screws. ***You will need to press down on the bracket in order to line up the holes.** (This is intended as it assures a snug fit for your monitor). Using the M3 wrench provided, tighten the M3 nuts. (Be sure the rounded part of the nut is facing upward).

Step 5

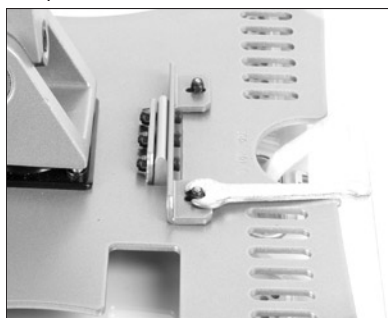

Use the M3 wrench to lock the (2) M3 nuts on the slide bar.

Step 1



After the mount is securely fastened, insert the shaft of the arm into the mount cup. For the example the Through-Desk configuration was used.

Step 2



After securing the bracket to the flat panel monitor, insert the shaft of the tilt mechanism into the forearm.

Step 3

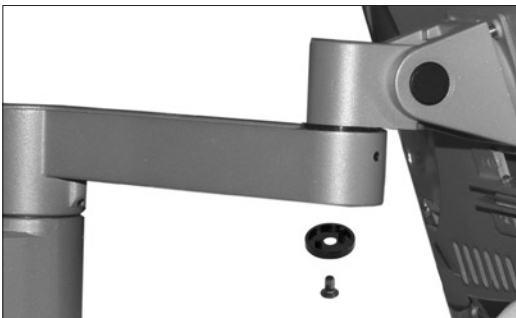

Fasten the 10-32 x 3/8" Philips Flat Head screw and washer into the hole in the bottom of the tilt mechanism to secure the monitor onto the arm.

Step 1 *** Cable clip is for Apple Monitor cable only. Other cables may be hidden within the arm as shown in Step 2.**



Tuck the Apple monitor cord underneath the forearm, snap the cable clip into place.

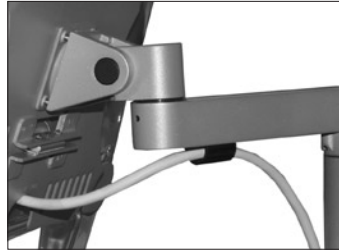

Be sure to leave enough slack for cables to loop around the elbow of the arm.

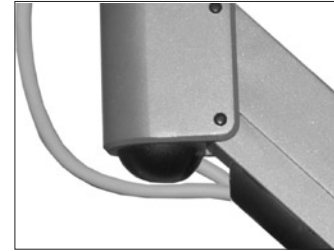

Step 2
The remaining cables can be hidden within the arm by following the steps and diagrams below. Feed the cables through the endcap (elbow), up through the opening in the other end of the forearm. Align the Forearm Cap over the forearm and snap into place. Align the Endcap Bumper over the bottom of the endcap and snap into place.

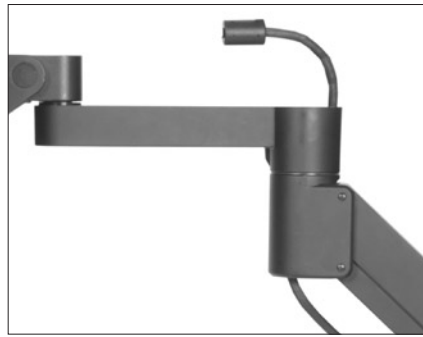
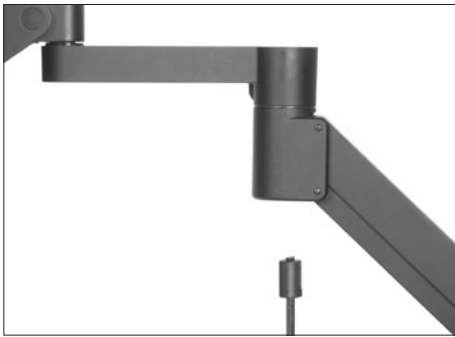

Included with your kit is a USB extension plug. Connect the end of the USB extension into the end of the USB coming out of the keyboard. Feed the cord through the arm as above step indicates.

Step 3
Tuck the monitor cable, USB extension and the remaining cables through the opening slot of the lower channel of the arm. Slide the plastic cable trough into place until it locks.

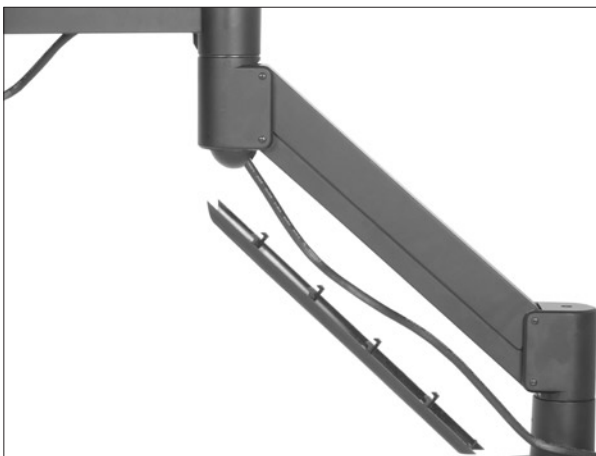



Adjusting Tilt

Using the 7/32" allen wrench, tilt the monitor so it faces up and locate the set screw under the tilter.

To tighten friction, lightly turn the wrench to the right (clockwise).

To loosen, lightly turn the wrench to the left (counter-clockwise).

When your monitor moves with ease, stays tilted in the up or down position, the friction is set.



**Due to the different curvature of the various monitor sizes, you may discover space between the back of your monitor and the top pads of the bracket. This space will not affect the support that your monitor receives. If you feel uncomfortable with this space, you may uninstall the bracket and bend the top two arms forward until they touch the back of your display.*



Adjusting Counter-balance

*The monitor MUST be attached before adjusting the counter-balance.

*It is important to hold the arm in a horizontal position before beginning.

Use the 7/32" allen wrench and insert into the top of the end cap. Turn left (counter-clockwise) to strengthen. Turn right (clockwise) to weaken the arm.

Adjusting Articulation Joints

Use the 3/32" allen wrench to tighten the friction joints found at the three articulation points until you get the feel of how you would like your monitor to move.

Your set-up is complete. Please call our customer service department at 800.524.2744 if you require additional assistance with this product or require a return authorization number.



Other products available from Innovative include special stands for holding double monitors or for pivoting LCD's, keyboard arms and wall mounts.

Wall Mounts



Keyboard Mounting



Stands

