

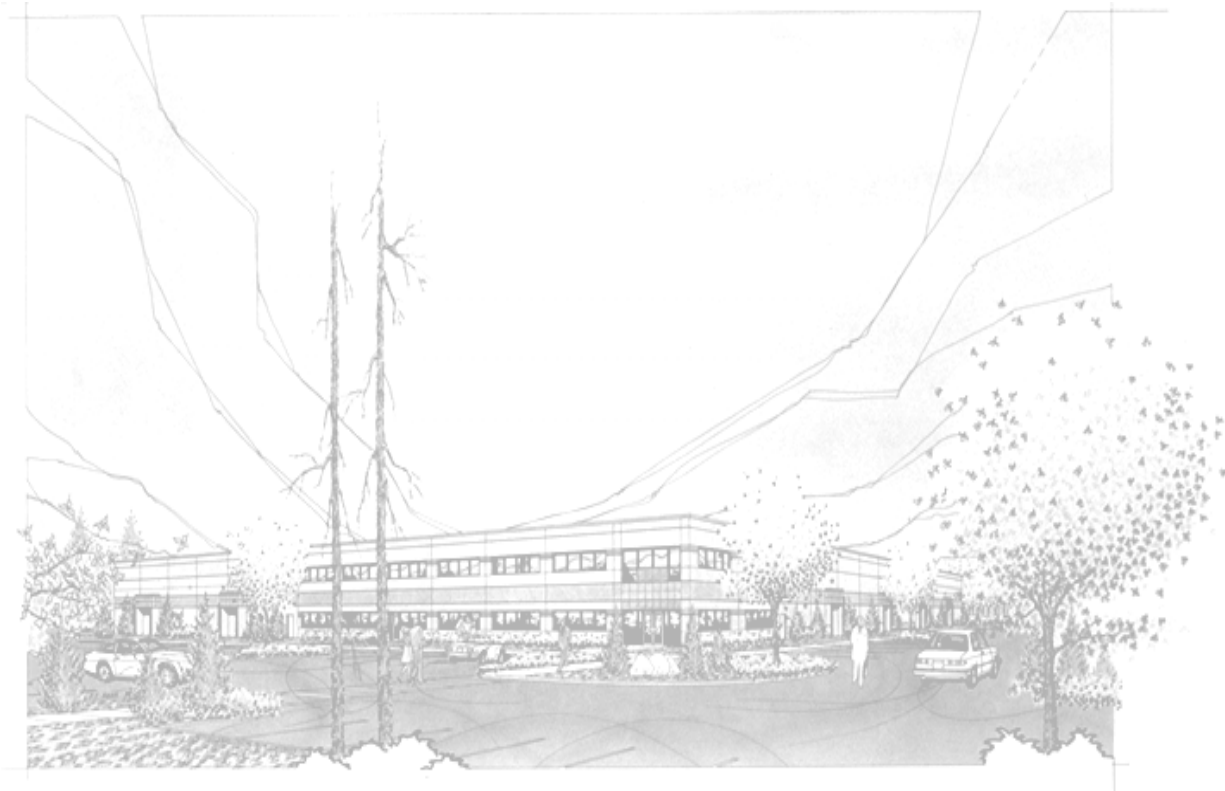

Installation, Operation, Maintenance, & Troubleshooting
Model: CLGPB-36A-S Electric Cruise Line Griddle, Pickle Barrel
Serial:



THIS MANUAL MUST BE RETAINED FOR FUTURE REFERENCE. READ, UNDERSTAND AND FOLLOW THE INSTRUCTIONS AND WARNINGS CONTAINED IN THIS MANUAL.

FOR YOUR SAFETY
DO NOT STORE OR USE GASOLINE OR OTHER FLAMMABLE VAPORS AND LIQUIDS IN THE VICINITY OF THIS OR ANY OTHER APPLIANCE.

WARNING: IMPROPER INSTALLATION, ADJUSTMENT, ALTERATION, SERVICE OR MAINTENANCE CAN CAUSE PROPERTY DAMAGE, INJURY OR DEATH. READ THE INSTALLATION, OPERATING AND MAINTENANCE INSTRUCTIONS THOROUGHLY BEFORE INSTALLING OR SERVICING THIS EQUIPMENT.





<u>DANGER</u>	POTENTIALLY HAZARDOUS SITUATION WHICH, IF NOT AVOIDED, COULD RESULT IN DEATH.	
<u>WARNING</u>	POTENTIALLY HAZARDOUS SITUATION WHICH, IF NOT AVOIDED, COULD RESULT IN DEATH OR SERIOUS INJURY.	
<u>CAUTION</u>	POTENTIALLY HAZARDOUS SITUATION WHICH, IF NOT AVOIDED, MAY RESULT IN MINOR OR MODERATE INJURY.	
<u>NOTICE</u>	Helpful operation and installation instructions and tips are present.	

TABLE OF CONTENTS

CHAPTER	PAGE
1. TABLE OF CONTENTS	3
2. READ FIRST	4
3. UNPACKING	5
4. INSTALLATION	6
5. INITIAL START-UP	7
6. OPERATION	8
7. CLEANING	9
8. TROUBLESHOOTING	10
9. PARTS LIST	11
10. EXPLODED VIEWS	12
11. WIRING DIAGRAM	15
12. WARRANTY	17

<u>CAUTION</u>	THE GRIDDLE IS EXTREMELY HEAVY. FOR SAFE HANDLING, INSTALLER SHOULD OBTAIN HELP AS NEEDED, OR EMPLOY APPROPRIATE MATERIALS HANDLING EQUIPMENT (SUCH AS A FORKLIFT, DOLLY, OR PALLET JACK) TO REMOVE THE UNIT FROM THE SKID AND MOVE IT TO THE PLACE OF INSTALLATION.
<u>CAUTION</u>	ANY STAND, COUNTER OR OTHER DEVICE ON WHICH GRIDDLE WILL BE LOCATED MUST BE DESIGNED TO SUPPORT THE WEIGHT OF THE GRIDDLE.
<u>CAUTION</u>	SHIPPING STRAPS ARE UNDER TENSION AND CAN SNAP BACK WHEN CUT.
<u>DANGER</u>	THIS APPLIANCE MUST BE GROUNDED AT THE TERMINAL PROVIDED. FAILURE TO GROUND THE APPLIANCE COULD RESULT IN ELECTROCUTION AND DEATH.
<u>WARNING</u>	INSTALLATION OF THE UNIT MUST BE DONE BY PERSONNEL QUALIFIED TO WORK WITH ELECTRICITY. IMPROPER INSTALLATION CAN CAUSE INJURY TO PERSONNEL AND/OR DAMAGE TO EQUIPMENT. UNIT MUST BE INSTALLED IN ACCORDANCE WITH ALL APPLICABLE CODES.
<u>NOTICE</u>	The data plate is located behind the access panel in the back of the griddle. The griddle voltage, wattage, serial number, wire size, and clearance specifications are on the data plate. This information should be carefully read and understood before proceeding with the installation.
<u>NOTICE</u>	The installation of any components such as a vent hood, grease extractors, fire extinguisher systems, must conform to their applicable National, State and locally recognized installation standards.
<u>CAUTION</u>	ALWAYS KEEP THE AREA NEAR THE APPLIANCE FREE FROM COMBUSTIBLE MATERIALS.
<u>CAUTION</u>	KEEP FLOOR IN FRONT OF EQUIPMENT CLEAN AND DRY. IF SPILLS OCCUR, CLEAN IMMEDIATELY, TO AVOID THE DANGER OF SLIPS OR FALLS.
<u>WARNING</u>	KEEP WATER AND SOLUTIONS OUT OF CONTROLS. NEVER SPRAY OR HOSE CONTROL CONSOLE, ELECTRICAL CONNECTIONS, ETC.
<u>CAUTION</u>	MOST CLEANERS ARE HARMFUL TO THE SKIN, EYES, MUCOUS MEMBRANES AND CLOTHING. PRECAUTIONS SHOULD BE TAKEN TO WEAR RUBBER GLOVES, GOGGLES OR FACE SHIELD AND PROTECTIVE CLOTHING. CAREFULLY READ THE WARNING AND FOLLOW THE DIRECTIONS ON THE LABEL OF THE CLEANER TO BE USED.
<u>NOTICE</u>	Service on this, or any other, LANG appliance must be performed by qualified personnel only. Consult your authorized service station directory or call the factory at 1-800-224-LANG (5264), or WWW.LANGWORLD.COM for the service station nearest you.
<u>WARNING</u>	BOTH HIGH AND LOW VOLTAGES ARE PRESENT INSIDE THIS APPLIANCE WHEN THE UNIT IS PLUGGED/WIRED INTO A LIVE RECEPTACLE. BEFORE REPLACING ANY PARTS, DISCONNECT THE UNIT FROM THE ELECTRIC POWER SUPPLY.
<u>CAUTION</u>	USE OF ANY REPLACEMENT PARTS OTHER THAN THOSE SUPPLIED BY LANG OR THEIR AUTHORIZED DISTRIBUTORS CAN CAUSE BODILY INJURY TO THE OPERATOR AND DAMAGE TO THE EQUIPMENT AND WILL VOID ALL WARRANTIES.



3.1 Receiving the Griddle

Upon receipt, check for freight damage, both visible and concealed. Visible damage should be noted on the freight bill at the time of delivery and signed by the carrier's agent. Concealed loss or damage means loss or damage, which does not become apparent until the merchandise has been unpacked. If concealed loss or damage is discovered upon unpacking, make a written request for inspection by the carrier's agent within 15 days of delivery. All packing material should be kept for inspection. Do not return damaged merchandise to Lang Manufacturing Company. File your claim with the carrier.

3.2 Location

Prior to un-crating, move the griddle as near its intended location as practical. The crating will help protect the unit from the physical damage normally associated with moving it through hallways and doorways.

3.3 Un-crating

The griddle will arrive completely assembled inside a wood frame covered by cardboard box and strapped to a skid. **Remove the cardboard cover, cut the straps and remove the wood frame.**

Remove griddle from skid and place in intended location.

CAUTION THE GRIDDLE IS EXTREMELY HEAVY. FOR SAFE HANDLING, INSTALLER SHOULD OBTAIN HELP AS NEEDED, OR EMPLOY APPROPRIATE MATERIALS HANDLING EQUIPMENT (SUCH AS A FORKLIFT, DOLLY, OR PALLET JACK) TO REMOVE THE UNIT FROM THE SKID AND MOVE IT TO THE PLACE OF INSTALLATION.



CAUTION ANY STAND, COUNTER OR OTHER DEVICE ON WHICH GRIDDLE WILL BE LOCATED MUST BE DESIGNED TO SUPPORT THE WEIGHT OF THE GRIDDLE.



CAUTION SHIPPING STRAPS ARE UNDER TENSION AND CAN SNAP BACK WHEN CUT.



INSTALLATION

DANGER THIS APPLIANCE MUST BE GROUNDED AT THE TERMINAL PROVIDED. FAILURE TO GROUND THE APPLIANCE COULD RESULT IN ELECTROCUTION AND DEATH.



WARNING INSTALLATION OF THE UNIT MUST BE DONE BY PERSONNEL QUALIFIED TO WORK WITH ELECTRICITY. IMPROPER INSTALLATION CAN CAUSE INJURY TO PERSONNEL AND/OR DAMAGE TO EQUIPMENT. UNIT MUST BE INSTALLED IN ACCORDANCE WITH ALL APPLICABLE CODES.



NOTICE The data plate is located behind the access panel in the back of the griddle. The griddle voltage, wattage, serial number, wire size, and clearance specifications are on the data plate. This information should be carefully read and understood before proceeding with the installation.



NOTICE The installation of any components such as a vent hood, grease extractors, fire extinguisher systems, must conform to their applicable National, State and locally recognized installation standards.



4.1 Electrical Connection

There is one power supply connection on the griddle. Refer to the power supply chart on the bottom of this page for proper power supply size.

The installer will provide a knockout location in the rear or the bottom of the griddle.

Use a supply wire suitable for at least 90° C.

4.2 Griddle Voltage

The model CLGPB-36A-S griddle is shipped from the factory wired for 440 volts.

4.3 Phasing

All griddles are shipped from the factory set up for a **three-phase** service.

GRIDDLE SPECIFICATIONS					
MODEL NUMBER	TOTAL kW	NOMINAL AMPS PER LINE			WEIGHT
		THREE PHASE			
		440 VOLT			
		LINE 1	LINE 2	LINE 3	
CLG-36PB-S	18.0	21.7	21.7	21.7	405 lbs.

5.1 Initial Start Up

Before starting the griddle for the first time, clean the griddle body and cooking surface with a mild soap and water solution then rinse with clear water and dry.

Set the temperature dials to 200 degrees.

Heat the griddle at 200 degrees for 2 hours to evaporate any moisture that may be in the elements.

After 2 hours at 200 degrees, proceed with "SEASON THE GRILL SURFACE".

5.2 Season the Grill

The cooking surface must be "seasoned" in order to reduce product sticking.

To season, heat the griddle to 250 degrees.

Once at 250 degrees, coat the cooking surface with a non-salted vegetable oil.

Allow the griddle to stand at 250 degrees until the cooking surface looks dry then coat it again.

Heat the griddle to 350 degrees and repeat the procedure.

The griddle may emit a small amount of smoke as the cooking surface passes the 350° point. Do not be alarmed as oils associated with the manufacturing process may cause smoke and will stop when the griddle reaches 350 degrees.

CAUTION

ALWAYS KEEP THE AREA NEAR THE APPLIANCE FREE FROM COMBUSTIBLE MATERIALS.

**CAUTION**

KEEP FLOOR IN FRONT OF EQUIPMENT CLEAN AND DRY. IF SPILLS OCCUR, CLEAN IMMEDIATELY, TO AVOID THE DANGER OF SLIPS OR FALLS.



6.1 Setting the Temperature

If different temperature settings across the same griddle are to be used, select one side of the griddle and run that at the lowest temperature. Adjoining sections should be set at progressively higher temperatures. Do not try to run end sections hot and center sections cool.

6.2 Loading the Grill

An understanding of how the griddle sections are controlled will be a valuable aid in loading your griddle.

A thermostat independently controls each 12-inch section. The sensor for each is mounted under the griddle plate in the center of each cooking section.

If product is loaded directly over the temperature sensor, that section will turn on and the element will heat the entire cooking section. If the product is loaded to the side, front or back of the temperature sensor, the controller will react to the temperature change of the entire section instead of just one product.

During slow periods minimal loads, do not load directly over the temperature sensors as this will unnecessarily turn the elements on and over heat the remainder of the section not being utilized.

During busy periods, a systematic approach should be utilized in loading the griddle. Load the entire section from rear to front and continue cooking to the next section if necessary.

Turn the product and continue cooking until it has reached its desired degree of doneness.

Remove the product from the griddle.

When reloading the griddle, first use the griddle surface on which a previous load was not placed. This will ensure the proper griddle temperature.

WARNING

KEEP WATER AND SOLUTIONS OUT OF CONTROLS. NEVER SPRAY OR HOSE CONTROL CONSOLE, ELECTRICAL CONNECTIONS, ETC.

**CAUTION**

MOST CLEANERS ARE HARMFUL TO THE SKIN, EYES, MUCOUS MEMBRANES AND CLOTHING. PRECAUTIONS SHOULD BE TAKEN TO WEAR RUBBER GLOVES, GOGGLES OR FACE SHIELD AND PROTECTIVE CLOTHING. CAREFULLY READ THE WARNING AND FOLLOW THE DIRECTIONS ON THE LABEL OF THE CLEANER TO BE USED.



7.1 Daily Cleaning (after each meal)

Keep the griddle surface clean. After each cooking load, scrape the griddle surface with the grooved griddle cleaning tool to remove any carbonized grease.

The griddle surface should be cleaned and re-seasoned. Use a griddle stone, griddle pad, or liquid cleaner. Rub with the grain of the metal, being careful not to scrape the splashguard.

Clean the exterior of the appliance with a hot water and chlorine solution to maintain a gleaming appearance.

Be sure to rinse thoroughly and coat the cooking surface with a thin film of oil to prevent rusting.

Re-season the griddle plate after each cleaning (refer to page 8).

TROUBLESHOOTING

9.1 Symptoms

What follows is a chart of Symptoms and Possible Causes to aid in diagnosing faults with the oven.

Refer to the Symptoms column to locate the type of failure then to the Possible Cause for the items to be checked.

To test for a possible cause, refer to the TEST section and locate the Possible Cause then refer to test to identify test procedures.

SYMPTOM	POSSIBLE CAUSE
Griddle will not heat	<ul style="list-style-type: none"> Failed element Failed thermostat No power to cord outlet Open wire
Product burning	<ul style="list-style-type: none"> Product is cooked too long Failed thermostat
Product under done	<ul style="list-style-type: none"> Failed thermostat

NOTICE

Service on this, or any other, LANG appliance must be performed by qualified personnel only. Consult your authorized service station directory or call the factory at 1-800-224-LANG (5264), or WWW.LANGWORLD.COM for the service station nearest you.



WARNING

BOTH HIGH AND LOW VOLTAGES ARE PRESENT INSIDE THIS APPLIANCE WHEN THE UNIT IS PLUGGED/WIRED INTO A LIVE RECEPTACLE. BEFORE REPLACING ANY PARTS, DISCONNECT THE UNIT FROM THE ELECTRIC POWER SUPPLY.



9.2 TESTS

If an item on the list is followed by an asterisk (*), the work should be done by a factory authorized service representative.

Possible Cause	TEST
Product is cooked too long	<ul style="list-style-type: none"> No test available, operational condition
Failed thermostat	<ul style="list-style-type: none"> Check thermostat for continuity, or that it is cycling on & off
Failed element	<ul style="list-style-type: none"> Remove the wires and check for proper resistance across the element

CAUTION

USE OF ANY REPLACEMENT PARTS OTHER THAN THOSE SUPPLIED BY LANG OR THEIR AUTHORIZED DISTRIBUTORS CAN CAUSE BODILY INJURY TO THE OPERATOR AND DAMAGE TO THE EQUIPMENT AND WILL VOID ALL WARRANTIES.



PARTS LIST

Item #	Description	Part Number
1	Body Assembly, 3 Foot Pickle Barrel	LGCL-219-31
2	Plate Assembly, 3 Foot, Pickle Barrel	LGCL-723-31
3	Control Panel Assembly, Pickle Barrel	LGCL-725-31
4	Bottom Snout Cover	LGCL-416
5	Supply Wire Baffle	LGCL-227
6	Rear Cover	LGCL-507
7	Knob, Thermostat	70701-28
8	Griddle Stand Assembly	LGCL-710-3
9	Screw, 10-32 X .5, S/S Hex Head Cap	20111-09
10	Element, 440 Volt, 5991 Watts	11030-48
11	Nut, 10-32, Hex Head	20303-02
12	Element Pan, Zig-Zag	LGCL-439
13	Element Pan, Insulation	XL-424
14	Element Pan	LGCL-434
15	Washer, Stainless Steel, Flat	20203-05
16	Nut, Hex, Stainless Steel, 5/16-18	20303-07
17	Thermostat Holder	LGCL-504
18	Thermostat, Griddle, 550°F	30402-07
19	Terminal Block, 2 Pole,	30500-11
20	Wire Harness	LGCL-585
21	Ground Harness	LGCL-770
22	Hotel Pan, Pickle Barrel	73800-01
N/A	Grooved Griddle Brush	50100-05
N/A	Legs, 4", Adjustable	72500-12

EXPLODED VIEW

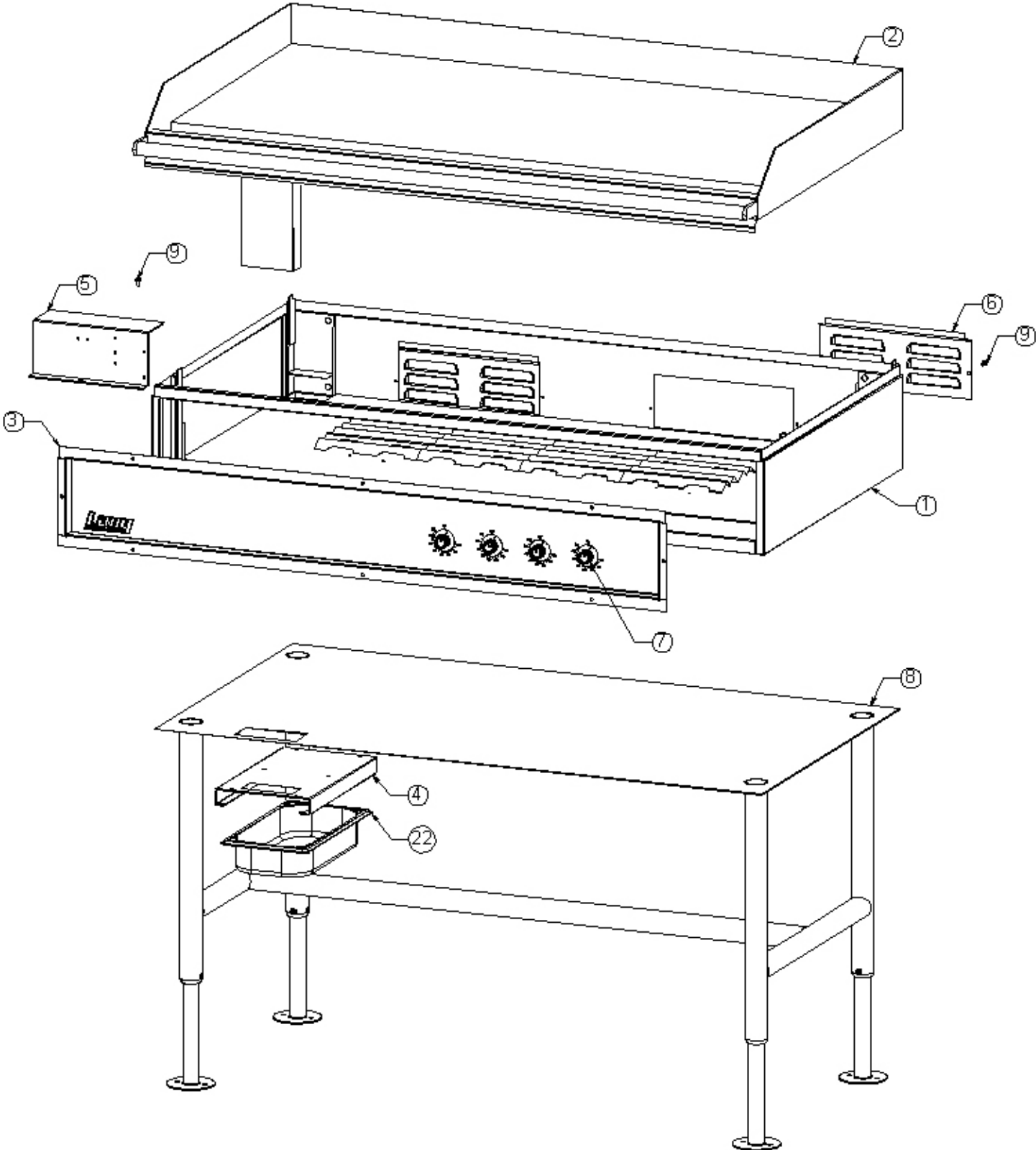

EXPLODED VIEW CONT'D

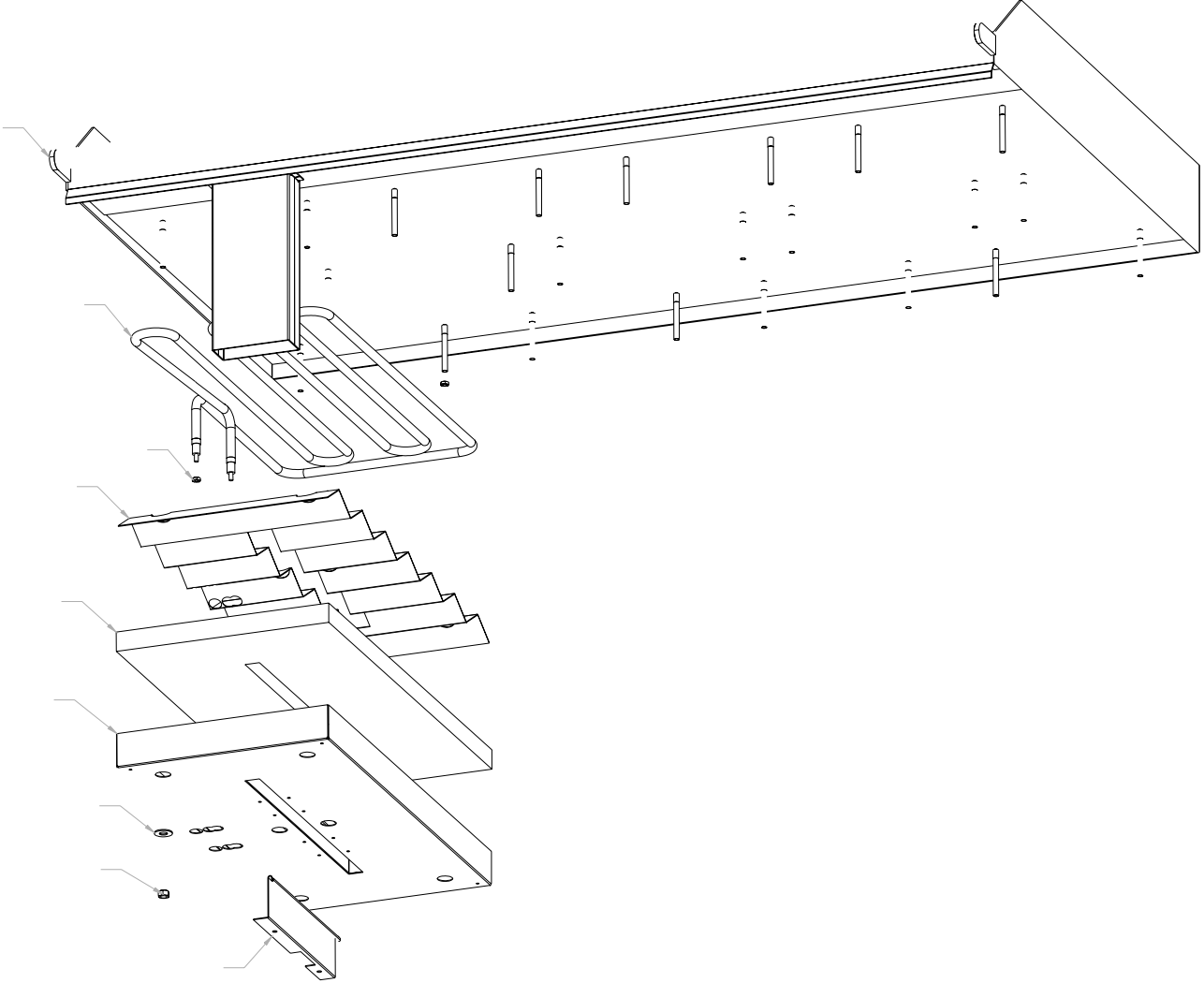

EXPLODED VIEW CONT'D

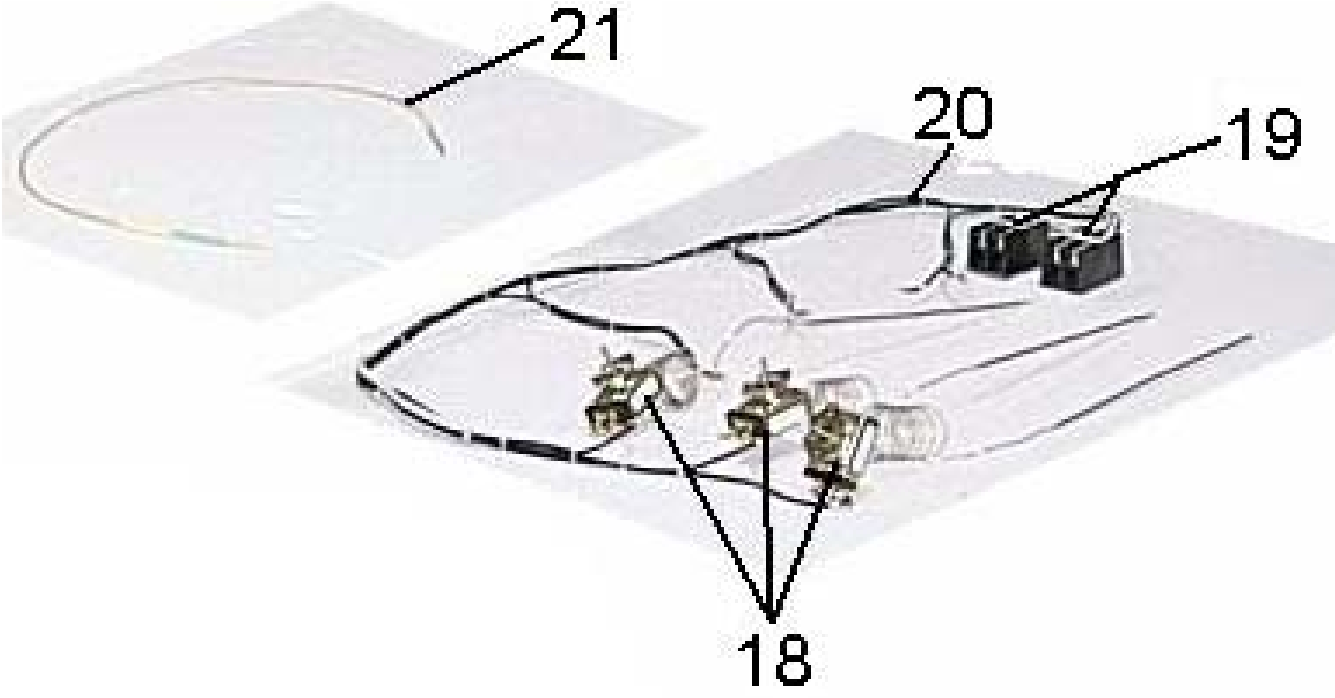

WIRING DIAGRAM

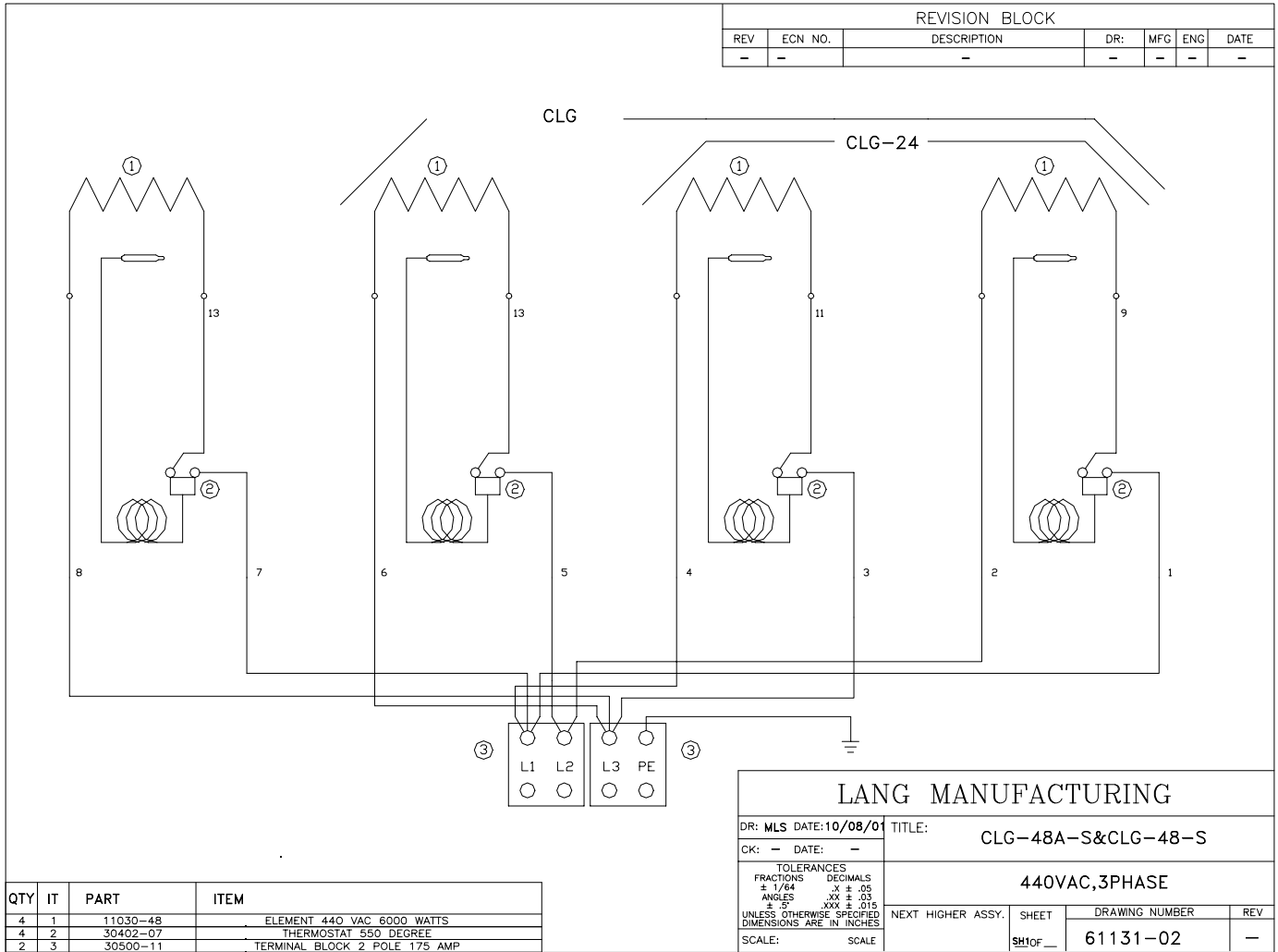

**THIS PAGE IS
INTENTIONALLY
LEFT BLANK**

Lang Manufacturing Limited Warranty to Commercial Purchasers* (Domestic U.S., Hawaii, & Canadian Sales only.)

Lang Manufacturing Equipment ("Lang Equipment") has been skillfully manufactured, carefully inspected and packaged to meet rigid standards of excellence. Lang warrants its Equipment to be free from defects in material and workmanship for (12) twelve consecutive months, with the following conditions and subject to the following limitations.

- I.** This parts and labor warranty is limited to Lang Equipment sold to the original commercial purchaser/users (but not original equipment manufacturers), at its original place of installation, in the continental United States, Hawaii and Canada.

Quartz elements are warranted for ninety(90) days from the date of installation.
- II.** Damage during shipment is to be reported to the carrier, is not covered under this warranty, and is the sole responsibility of purchaser/user.
- III.** Lang, or an authorized service representative, will repair or replace, at Lang's sole election, and Lang Equipment, including but not limited to, safety valves, gas and electric components, found to be defective during the warranty period. As to warranty service in the territory described above, Lang will absorb labor and portal to portal transportation costs (time & mileage) for the first (12) twelve months from the date of installation or eighteen (18) months from date of shipment from Lang Manufacturing, which ever comes first.
- IV.** This warranty does not cover routine general maintenance, periodic adjustments, as specified in operating instructions or manuals, and consumable parts such as quartz elements, or labor costs incurred for removal of adjacent equipment or objects to gain access to Lang Equipment. This warranty does not cover defects caused by improper installation, abuse, careless operation, or improper maintenance of equipment.
- V.** THIS WARRANTY IS EXCLUSIVE AND IS IN LIEU OF ALL OTHER WARRANTIES, EXPRESSED OR IMPLIED, INCLUDING ANY IMPLIED WARRANTY OF MERCHANTABILITY OR FITNESS FOR A PARTICULAR PURPOSE, EACH OF WHICH IS HEREBY EXPRESSLY DISCLAIMED. THE REMEDIES DESCRIBED ABOVE ARE EXCLUSIVE AND IN NO EVENT SHALL LANG BE LIABLE FOR SPECIAL, CONSEQUENTIAL OR INCIDENTAL DAMAGES FOR THE BREACH OR DELAY IN PERFORMANCE OF THIS WARRANTY.
- VI.** Lang Equipment is for commercial use only. If sold as a component of another(OEM) manufacturer's equipment, or if used as a consumer product, such Equipment is sold AS IS and without any warranty.