

WINDOW TYPE ROOM AIR CONDITIONER



OPERATION MANUAL

HW-09LN03

HW-12LN03

- Please read this operation manual before using the air conditioner.

No.0010515690

Contents

Contents	1
Parts and Functions	2-3
Operation Guide	4-9
Maintenance	10-13
Installation Instruction	14-15
Wiring Diagram	16

The machine is adaptive in following situation:

1. Applicable ambient temperature range:

Cooling	Indoor	Maximum: D.B/W.B Minimum: D.B/W.B	32 °C/23 °C 18 °C/14 °C
	Outdoor	Maximum: D.B/W.B Minimum: D.B	43 °C/26 °C 18 °C

2. If the supply cord is damaged, it must be replaced by the manufacturer or its service agent or a similar qualified person.
3. After installation, the power plug should be easily reached.
4. The wiring method should be in line with the local wiring standard.

Parts and Functions

Machine body

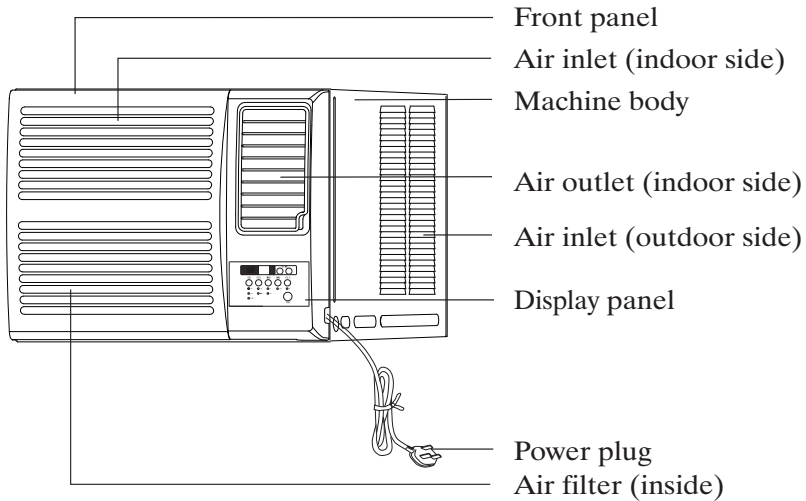

Control panel

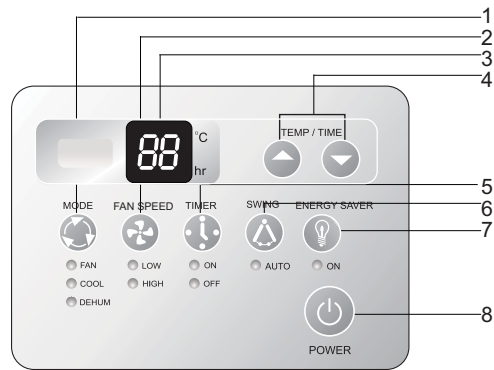

1. **MODE**
Used to select operation mode:FAN,COOL,DEHUM.
2. **FAN SPEED**
Used to select desired fan speed:HIGH or LOW.
3. **TEMP./TIME display**
4. **TEMP. or TIME set**
Used to set TIME or TEMP. setting.
5. **TIMER**
Used for TIMER start or stop .
6. **SWING**
Used to activate the vertical louver.This will give you an even airflow throughout the room.
7. **ENERGY SAVER**
Used to activate ENERGY SAVER option,reduce energy consumption and noise.
8. **POWER**
Press it to start unit and press it again to stop.

Parts and Functions

Remote controller

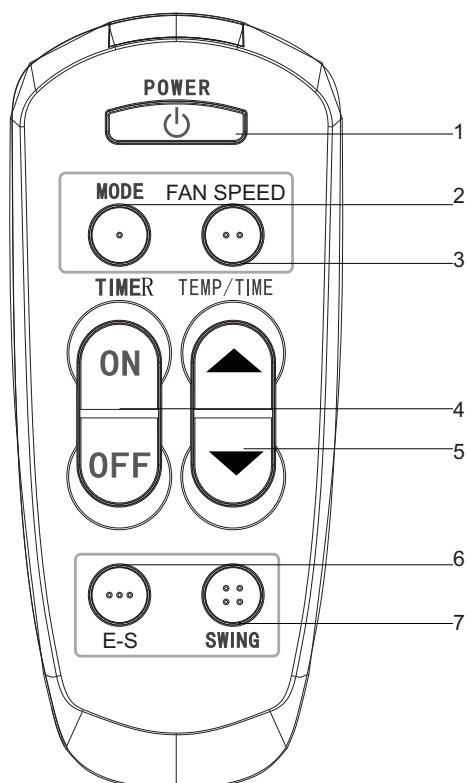

- 1. POWER**
Press it to start unit and press it again to stop.
- 2. MODE**
Used to select operation mode:
FAN, COOL, DEHUM.
- 3. FAN SPEED**
Used to select desired fan speed.
- 4. TIMER button**
Used for TIMER start or stop .
- 5. TEMP. or TIME set**
Used to set TIME or TEMP . setting.
- 6. E-S**
ENERGY SAVER
- 7. SWING**
Used to activate the vertical louver. This will give you an even airflow throughout the room.

Remote controller's operation

- When in use, put the signal transmission head directly to the receiver hole on the indoor unit.
- Don't throw the controller, prevent it from being damaged.
- When electronic-started type fluorescent lamp or change-over type fluorescent lamp or wireless telephone is installed in the room, the receiver is apt to be disturbed in receiving the signals so the distance to the indoor unit should be shorter.

COOL operation

1. Start

Press POWER button

2. Select operation mode

Press MODE button. For each press, operation mode changes as follows: \rightarrow FAN \rightarrow COOL \rightarrow DEHUM \rightarrow FAN \rightarrow COOL \rightarrow DEHUM

Then select COOL operation.

When the COOL display lights bright, the unit will be working under the cooling function.

3. Select temp. setting

Select desired temp., by using "▲" or "▼" button.

"▲" Each press will increase temp.setting by 1°C.

"▼" Each press will decrease temp.setting by 1°C.

4. Fan speed selection

If you choose the FAN SPEED mode you can run the fan in one of the 2 speeds: HIGH or LOW.

Select desired setting.

Change air flow direction if necessary.

5. Stop

Press POWER button again.

Remote controller

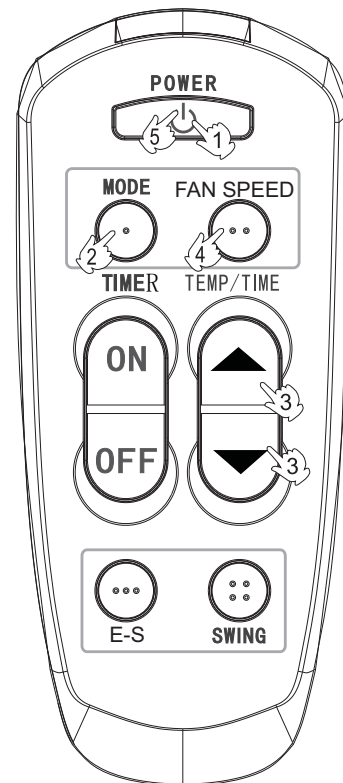

Control panel

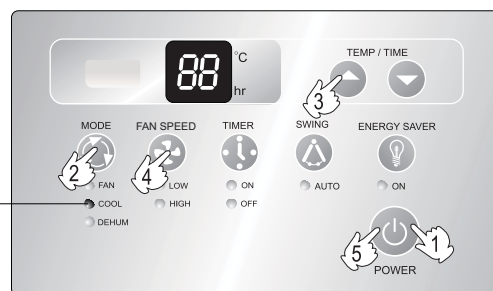

Cautions:

To protect unit system, don't restart until 3 minutes have elapsed.

If the unit has been running under large humidity for a long time, dew might occur at outlet grille.

DEHUMID mode

1. Start

Press POWER button.

2. Select operation mode

Press MODE button. For each press, operation mode changes as follows: $\square \rightarrow \text{FAN} \rightarrow \text{COOL} \rightarrow \text{DEHUM} \square$

Then select DEHUMID operation.

When the DEHUM display lights bright, The unit will be working under the dehumidify function.

If you need to only remove the moisture press the Dehnmid button. Change air flow direction if necessary.

3. Select temp. setting

Select desired temp., by using "▲" or "▼" button.

"▲" Each press will increase temp.setting by 1°C.

"▼" Each press will decrease temp.setting by 1°C.

4. Fan speed selection

If you choose the FAN SPEED mode you can run the fan in one of the 2 speeds:HIGH OR LOW.

Air conditioner is running under displayed fan speed.

In DRY mode, when room temperature becomes lower than temp.setting+2°C,unit will run intermittently at LOW speed regardless of FAN setting.

5. Stop

Press POWER button again.

Remote controller

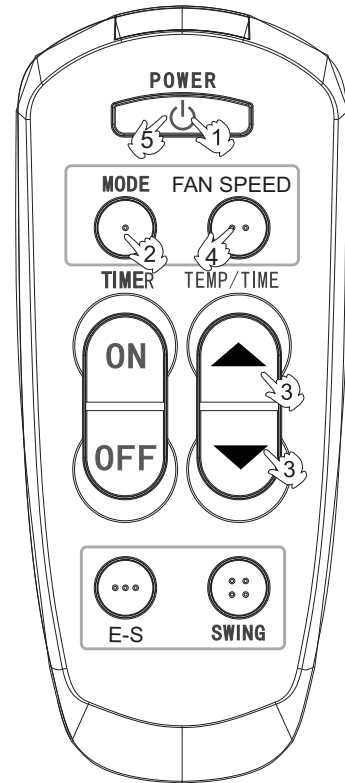

Control panel

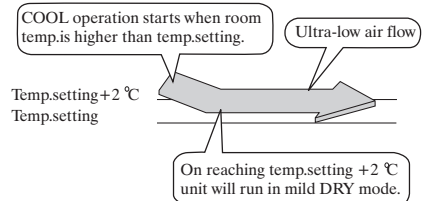
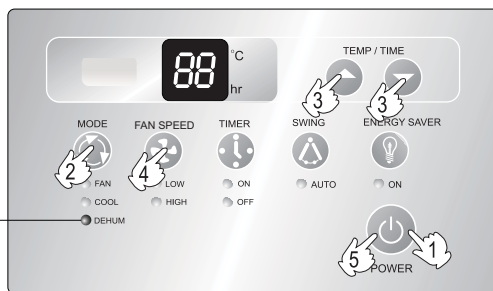

Cautions:

The compressor may cycle for 10 minutes on and 6 minutes off in Dehumid mode.

Air blown out will be very cold at relatively low room temp..

FAN operation

1. Start

Press POWER button.

2. Select operation mode

Press MODE button. For each press, operation mode changes as follows: → FAN → COOL → DEHUM

Then select FAN operation.

When the FAN display lights bright, the unit will be working under the fan operation.

In some days you may want to run the FAN function. Press the FAN button.

3. Fan speed selection

Here the fan runs only at HIGH or LOW speed.

Change air flow if necessary.

4. Stop

Press POWER button again.

Remote controller

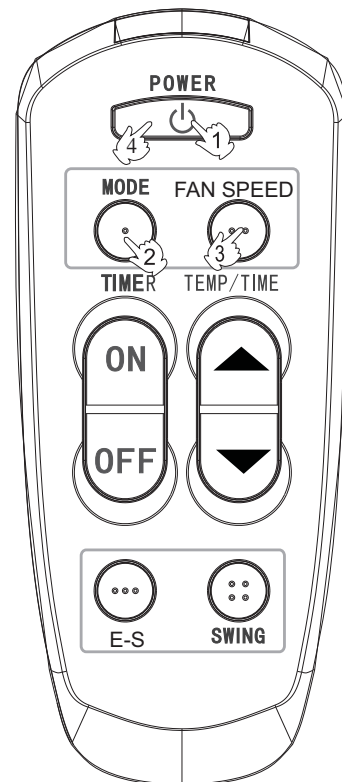

Control panel

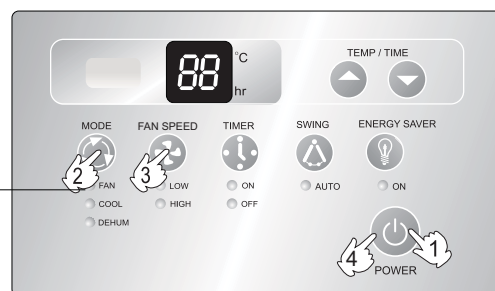

Hints

Compressor won't start in FAN mode, only fan motor will run at selected speed.

ENERGY SAVER operation

1. Start

Press POWER button.

2. Select operation mode

Press MODE button. For each press, operation mode changes as follows: → FAN → COOL → DEHUM

Then select COOL operation.

When the COOL display lights bright, the unit will be working under the COOL function.

Saving energy function only can be used when A/C working on cooling condition.

3. ENERGY SAVER selection

When this function is selected, the fan will shut off three minutes after the compressor cycles off. This will reduce energy consumption and noise. When the compressor turns back on, the fan will turn on at the same time. If this function is not selected, the fan will not shut off when the compressor cycles off.

4. Stop

Press POWER button again.

Remote controller

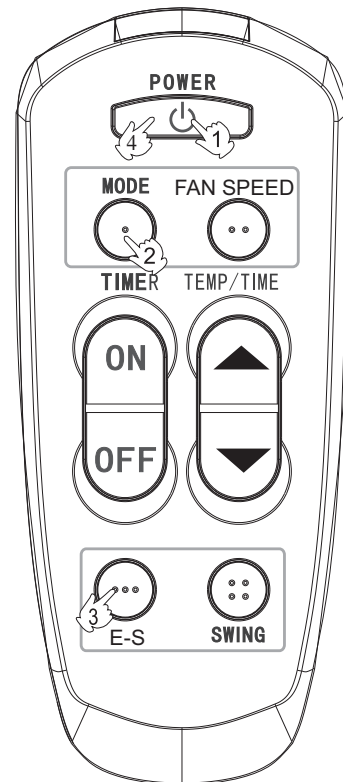

Control panel

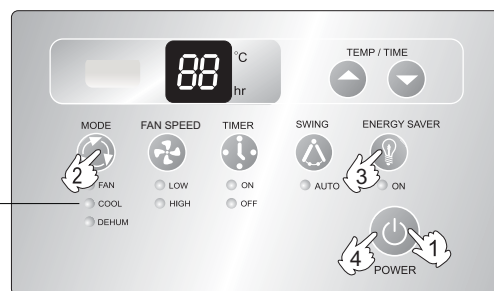

Timer operation

With this function, unit will start or stop at the time you want.

1. Start unit and select desired operation mode.
2. Select Timer function

Timer On or Off stop mode is used to preset or shut off your unit in advance .

You can program this up to 24 hours in advance. You can use the Timer in 3 functions i.e cool ,Dehumid, or Fan only. Select desired mode. (TIMER On or Off stop)

- **Timer On**

Unit must be on to set the timer. Unit will shut down automatically after it accepts the settings in 5 seconds. Use this mode to preset the start time of the unit 24 hours in advance.

- a) Press "On" of remote controller or "TIMER" of control panel, LED display will show "01". (Electrify for the first time)
- b) Set desired number by pressing the (▲) pad of the Temp/Time buttons. One for each hour .If you passed the desired time use the (▼) pad key to lower the selection.

- **Timer Off**

Unit must be running to set the timer off. Use this to preset the time you would like the unit to shut off.

- a) Press "Off" of remote controller or "TIMER" of control panel, LED display will show "01". (Electrify for the first time)
- b) Set desired number by pressing the (▲) pad of the Temp/Time buttons. One for each hour. If you passed the desired time, use the (▼) pad key to lower the selection.

When using the **TIMER ON** the unit will revert to the last mode , fan settings when restarted .The timer must be reset every time you choose to use it.

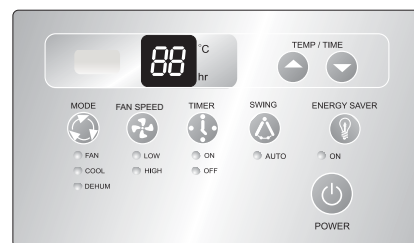
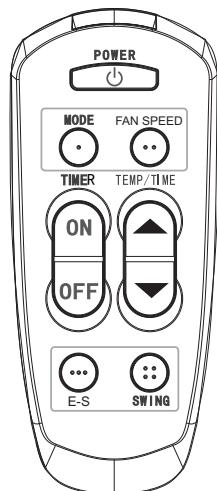

Function introduction

- Power failure resume(please set and apply as necessary)

If sudden power failure occurs, the unit will resume original operation when power is supplied again.

Note:

When sudden power failure happens during unit operation in power failure resume mode, if the air conditioner is not desired for use in a long period, please shut off the power supply in case that the unit automatically resume operation when power is re-supplied, or press POWER to turn off the unit when power resumes.

Operation

Adjusting of the air direction

Airflow Direction Vane

- The Vertical Airflow Direction Vane is manually controlled by positioning the vane to discharge the air upward, downward or straight out.
- The horizontal air direction is adjusted by setting the AUTO SWING ON .

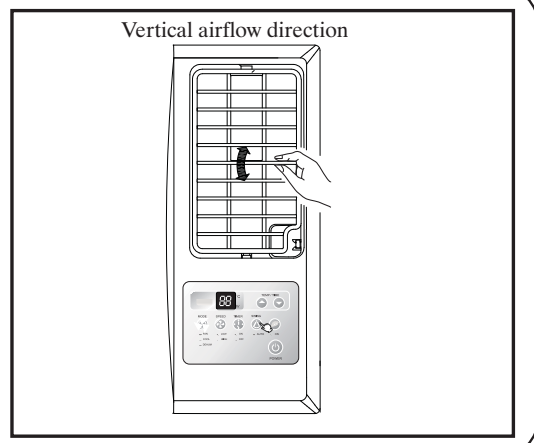

Note:

- It is advisable not to keep horizontal flap at downward position for a long time in COOL or FAN mode, otherwise , condensate water might occur.
- Don't move the vertical blade with hand in order to avoid the vertical blade abnormal, using the remote controller to adjust the move of vertical blade.

Maintenance

NOTE: Always unplug the air conditioner before servicing or moving it.

When dirt accumulates on air filter, air circulation will be blocked, which causes poor cooling. It is advisable to clean air filter every two weeks for longer operation.

Removal of air filter

1. Loosen the air inlet by pulling "▽" at both edges as shown.
2. Open the air inlet.
3. Remove the air filter.

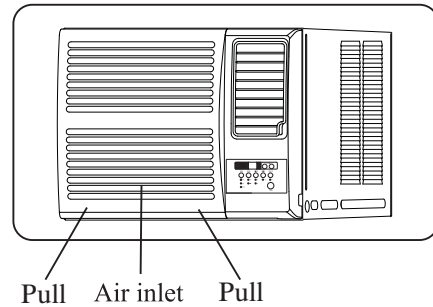

Air filter cleaning

1. Gently flap the dirt off the air filter.
2. Carefully wash air filter in warm water (below 40°C). To obtain better cleaning effect, soap water or neutral detergent may be used.
3. Flush air filter carefully with clean water after removing dirt. Let it dry completely.

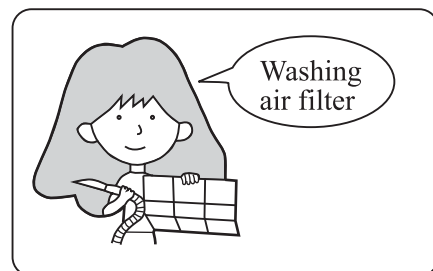

Installation of filter

1. Replacing the air filter.
2. Push the air inlet until you hear a click.

- "☐ CLOSE" position, the vent door opens to allow air, smoke or odors to be expelled from the room;
- "☐ OPEN" position, the vent door is closed and the air inside the room is circulated and conditioned.

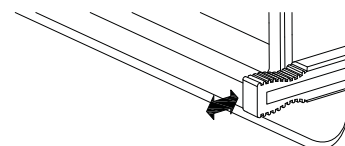

☐ CLOSE ☐ OPEN

Maintenance

- Avoid opening doors and windows unless necessary.

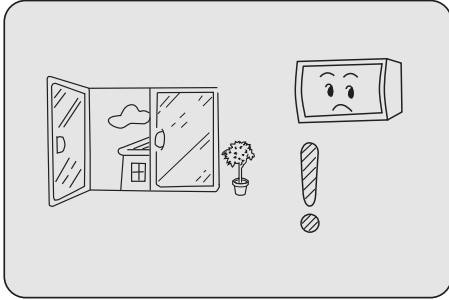

- Don't be exposed to cold air for a long time.

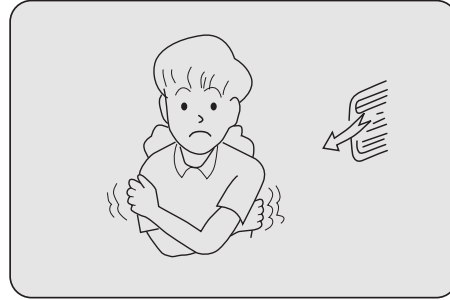

- Use curtain or blind
Direct sunlight may reduce cooling effect, always use window curtain.

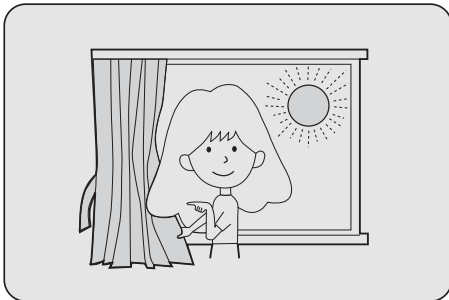

- Keep heat source away from air conditioner.

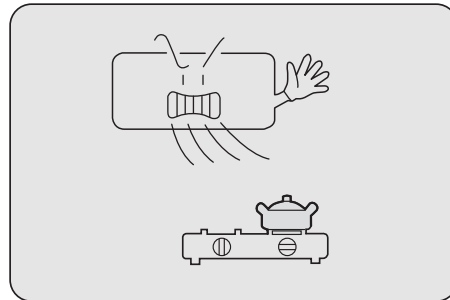

- Set temp . a little bit higher before going to bed.

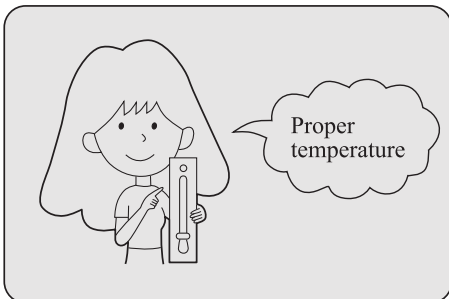

- After unit stops, don't restart it until 3 min. have elapsed.

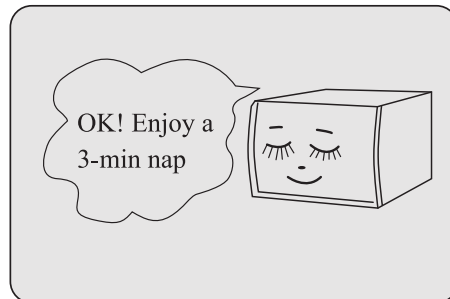

Maintenance

Disposal of the condensed water

Generally there are two methods available on disposal of the condensed water:

1. Block the bottom plate hole of the conditioner with rubber lid, install outlet pipe fitting on the back hole and let the condensing water flow from the back hole of the conditioner. (See Fig.1) In this method, the accumulated condensed water in the bottom plate is hit by the fan onto the heat exchanger, and evaporated and blown out from the machine. It can cool the heat exchanger radiator more quickly, and improve the energy efficiency of the conditioner. But the hitting noise by the fan at the outdoor side is relatively large.

2. Block the back hole of the conditioner with rubber lid and install outlet pipe fitting to the bottom hole, which can make the condensed water flow out from the bottom plate. (See Fig.2)

If necessary the above two methods can both have extra pipe added on the outlet pipe fitting. (available on the market).

(Refer to P15 for choosing these two modes.)

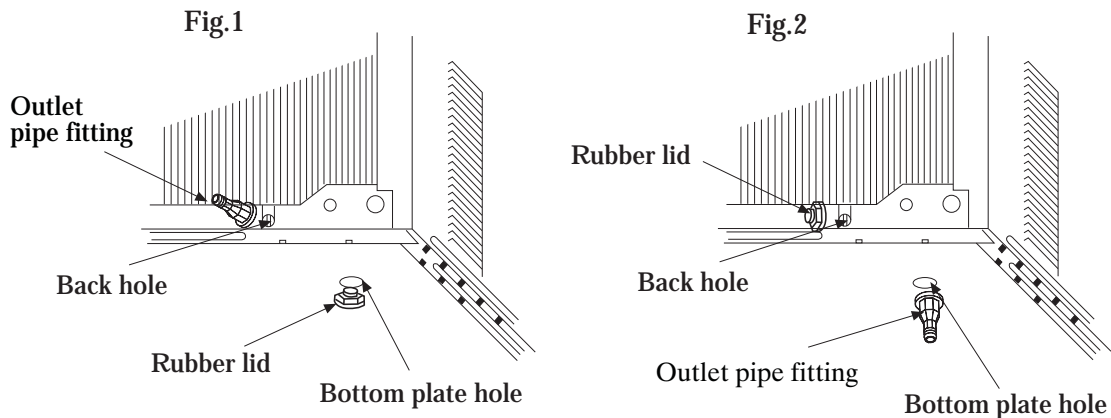

Cautions

- Power cord: Be sure to use the exclusive power cord.
- Change installation place: If air-con need to be changed to another place please contact the dealer, who sold you the unit.

Maintenance

Cleaning of the shell and remote controller

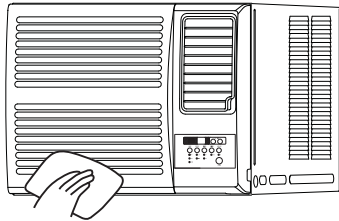

*Wipe the shell with soft cloth. If it is very dirty, please use water with diluted neutral detergent. In wiping, first twist out the water in the cloth.

*Wipe out the detergent on the machine shell completely.

Trouble shooting

Before sending to repair, please first check the following:

Phenomenon	Reason
Switch on the machine but it does not work immediately.	If the machine is started after stop, it will need about 3 minutes to re-start so as to prevent the fuse from break.
Switch on the machine but it does not work.	<ol style="list-style-type: none">1. Is the power on?2. Is the fuse broken?3. Is plug firmly inserted?
The cooling effect is not good.	<ol style="list-style-type: none">1. Is the air inlet or outlet entrance blocked?2. Is there direct sunlight in cooling?3. Are the doors and windows closed?4. In cooling are there too many heating sources?5. Is the filter too dirty (generally it should be washed every two weeks)?

Installation instruction

Selection of the installation position

1. The air-conditioner is better installed in shadow or in a place with short period of sunshine. In case the air-conditioner is installed at the point exposed directly to the sunshine, it should be protected from the direct sunlight as possible in order to avoid the long time of direct sunlight otherwise its performance will be lowered. (As illustrated in Fig. 1).
2. For the convenience of operation, it is recommended that air-conditioner be installed at least at the height of 760-1300 mm above the floor and no obstacles before it for a free airflow.
3. The shutters at both sides and the top of air-conditioner should be protruded outdoors free from being blocked by wall, window, etc.
4. The back of air-conditioner should be kept over 500mm from the obstacles (for example, wall, etc.) (As illustrated in Fig. 2).
5. To have an efficient drainage, the back part of the air-conditioner should be inclined downward by 5-10mm (As illustrated in Fig. 3).

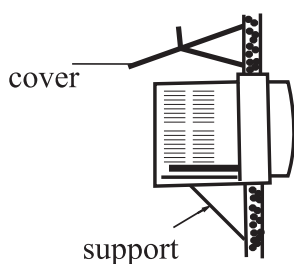

fig.1

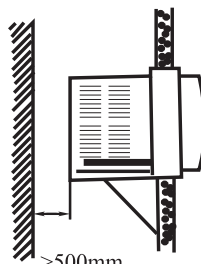

fig.2

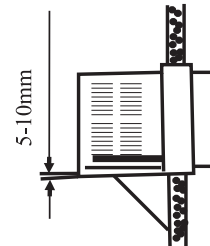

fig.3

The enclosed accessories of the conditioner are:

Name	Manual	Battery (R-03 dry battery)	Outlet pipe fitting	Sealed gasket	Rubber lid	Screw	Remote controller
Figure							
Quantity	1	2	1	1	1	3	1

Installation instruction

1. Make the wall hole or window hole (see Fig.1).

MODEL	A	B
HW-09LN03	366mm	481mm
HW-12LN03	392mm	610mm

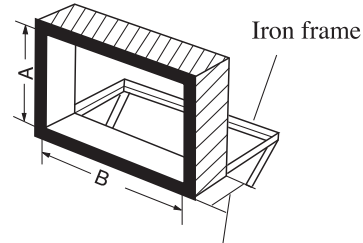

Fig.1 Width of the wall

2. Fix the prefabricated iron frame to stable position by expansible screws.
3. Take out the conditioner and accessories from the package .
4. Lift the back of the machine body slightly. You can see the drain hole at the back of the bottom plate. Plug the black rubber lid of the enclosed accessories into the hole. (see Fig. 2).

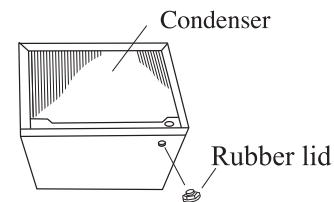

Fig.2

5. Plug the outlet pipe fitting of the enclosed accessories (with seal ring) into the drain hole on the vertical wall at the back of the bottom plate (see Fig. 3)
6. If you need to lead the condensed water to indicated position, please purchase a piece of plastic pipe with inner diameter of $\phi 16$, set it on the outlet pipe fitting and tie it tightly.

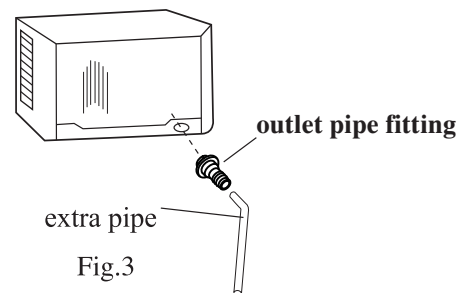

Fig.3

7. After installation of all the accessories, put the whole machine on the iron frame. If there's extra pipe, lead the pipe to needed position (see Fig.4).
8. Fill any distance between the wall hole and the machine body with flexible sponge rubber strip to prevent the entering of outer noise and the leaking of the coolness.
9. After installation of the conditioner, insert the power plug into the outlet and perform test-run.

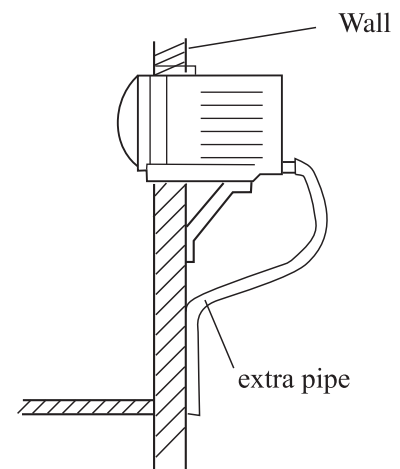
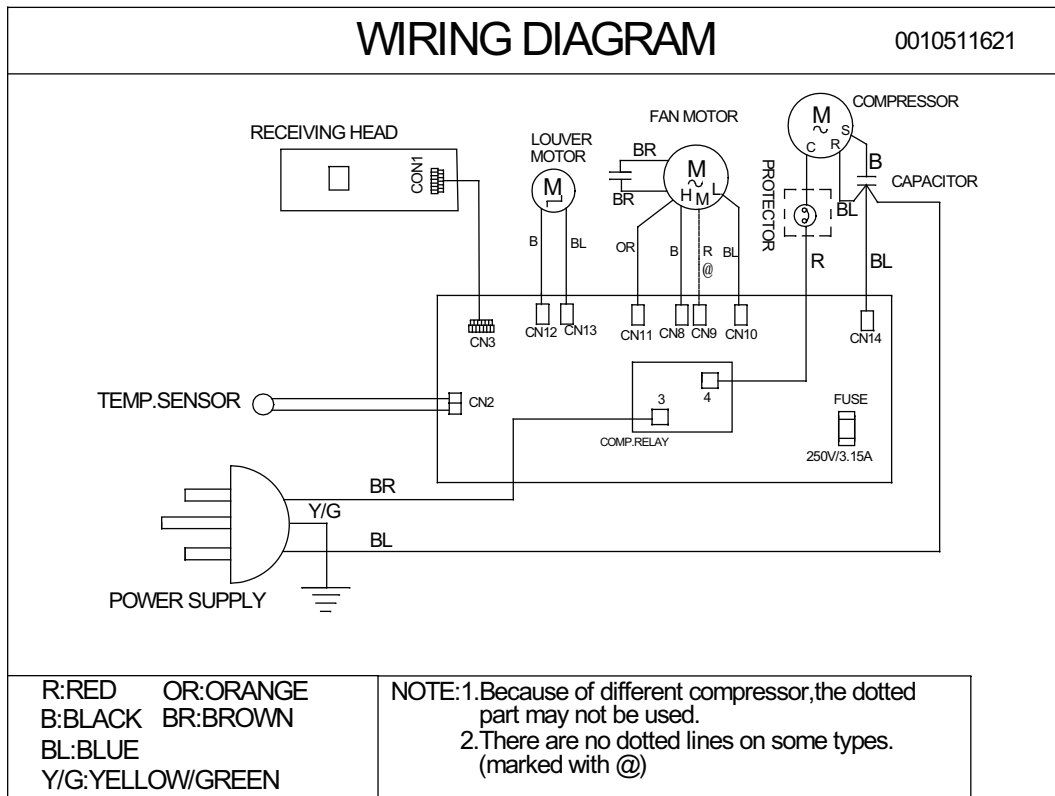

Fig. 4

Wiring Diagram



	Capacity(BTU)	Power input/ Rated power input (W)	Current/Rated current(A)	Circulation Airflow(m ³ /h)	Dehumidification Capacity(10.M/h)	Dimensions(indoor unit) D*W*H(mm)	Net weight (Kg)	12 Month Guarantee
HW-09LN03	9000	980/1500	4.4/6.9	360	1.0	531X471X356	29.5	Yes
HW-12LN03	12000	1250/1600	6.5/8.5	450	1.2	560X600X382	37	Yes

Note: All capacities are gross.
 Haier THERMOCOOL reserves the right to change specifications as part of its policy of continuous improvement.



Haier THERMOCOOL produce high quality air-conditioners, which are strong, reliable, elegantly styled-yet practical and long lasting for the most demanding tropical climate and conditions.

Haier THERMOCOOL new generation air-conditioners are convenient to use, highly efficient, energy saving and are built for quiet running to withstand voltage fluctuations.

unique **Haier THERMOCOOL** 12MONTH GUARANTEE gives you peace of mind and assured satisfaction from the moment of purchase. The 12 MONTH GUARANTEE covers:

- Free parts replacement under warranty
- Free repairs under warranty

With 3 years warranty on all air- conditioner compressors, you have peace of mind from the date of purchase

Unique **Haier THERMOCOOL** NATIONWIDE SALES AND SERVICES NETWORK offers you fast reliable service and replacement spare parts which will normally be available for many years. Sales and service is available in ILUPEJU, IBADAN, BENIN, WARRI, PORT HARCOURT, ABA, ENUGU, ONITSHA, KADUNA, KANO, JOS, MINNA, ILORIN, OSHOGBO, LOKOJA, MAIDUGURI, ABUJA, Contact HPZ or your local **Haier THERMOCOOL** distributor for information **Haier THERMOCOOL** reserves the right to amend specifications without notice as part of its continuous improvement programme. **Haier THERMOCOOL** is a registered trademark

HPZ Ltd

Haier THERMOCOOL sales office

45/47 Town Planning Way, Ilupeju PM.B 21132 Ikeja.
Lagos, Nigeria

TEL: 234-(0)1-4973470 Fax: 234-(0)1-2719790

E-mail: sales@hpz.com.ng

