

SMART Room System™ for Microsoft® Lync®

SETUP AND MAINTENANCE GUIDE

FOR MODELS SRS-LYNC-XS, SRS-LYNC-S, SRS-LYNC-M, SRS-LYNC-M-DUAL, SRS-LYNC-L AND SRS-LYNC-XL

SMART®

Product registration

If you register your SMART product, we'll notify you of new features and software upgrades.

Register online at smarttech.com/registration.

FCC warning

This equipment has been tested and found to comply with the limits for a Class A digital device, pursuant to Part 15 of the FCC Rules. These limits are designed to provide reasonable protection against harmful interference when the equipment is operated in a commercial environment. This equipment generates, uses and can radiate radio frequency energy and, if not installed and used in accordance with the manufacturer's instructions, may cause harmful interference to radio communications. Operation of this equipment in a residential area is likely to cause harmful interference in which case the user will be required to correct the interference at his own expense.

Trademark notice

SMART Room System, SMART Board, SMART Meeting Pro, SMART Ink, DVIT, smarttech, the SMART logo and all SMART taglines are trademarks or registered trademarks of SMART Technologies ULC in the U.S. and/or other countries. Microsoft, Windows, Lync, Outlook, PowerPoint and Office 365 are either registered trademarks or trademarks of Microsoft Corporation in the U.S. and/or other countries. Intel and vPro are trademarks or registered trademarks of Intel Corporation or its subsidiaries in the U.S. and other countries. DameWare is a registered trademarks of SolarWinds Worldwide, LLC. VNC is a registered trademark of RealVNC Ltd. in the U.S. and in other countries. All other third-party product and company names may be trademarks of their respective owners.

Copyright notice

© 2013–2014 SMART Technologies ULC. All rights reserved. No part of this publication may be reproduced, transmitted, transcribed, stored in a retrieval system or translated into any language in any form by any means without the prior written consent of SMART Technologies ULC. Information in this manual is subject to change without notice and does not represent a commitment on the part of SMART.

This product and/or use thereof covered by one or more of the following U.S. patents.

www.smarttech.com/patents

08/2014

Important information



IMPORTANT

If you were directed to this guide from your room system's quick start guide, proceed to *Configuring your room system's software* on page 17.



WARNING

- Failure to follow the installation instructions shipped with your SMART product could result in personal injury and product damage which may not be covered by your warranty.
- Ensure your installation complies with local building and electrical codes.
- Do not open or disassemble the SMART product. You risk electrical shock from the high voltage inside the casing. Opening the casing also voids your warranty.
- Do not stand (or allow children to stand) on a chair to touch the surface of your SMART product. Rather, mount the product at the appropriate height.
- To reduce the risk of fire or electric shock, do not expose your SMART product to rain or moisture.
- If your SMART product requires replacement parts, make sure the service technician uses replacement parts specified by SMART Technologies or parts with the same characteristics as the original.
- Ensure that any cables extending across the floor to your SMART product are properly bundled and marked to avoid a trip hazard.
- Do not insert objects inside the cabinet ventilation holes, because they could touch dangerous voltage points and cause electric shock, fire or product damage which may not be covered by your warranty.
- Do not place any heavy objects on the power cable. Damage to the cable could cause shock, fire or product damage which may not be covered by your warranty.
- Use only extension cords and outlets into which this product's polarized plug can be fully inserted.
- Use the power cable provided with this product. If a power cable is not supplied with this product, please contact your supplier. Use only power cables that match the AC voltage of the power outlet and that comply with your country's safety standards.

IMPORTANT INFORMATION

- If the glass is broken, do not touch the liquid crystal. To prevent injury, handle glass fragments with care when disposing of them.
- Do not move or mount the interactive flat panel by connecting rope or wire to its handles. Because the interactive flat panel is heavy, rope, wire or handle failure could lead to personal injury.
- Use SMART supplied mounting hardware or hardware that is designed to properly support the weight of your product.
- Disconnect all power cables for your interactive flat panel from the wall outlet and seek assistance from qualified service personnel when any of the following occurs:
 - The power cable or plug is damaged
 - Liquid is spilled into the interactive flat panel
 - Objects fall into the interactive flat panel
 - The interactive flat panel is dropped
 - Structural damage such as cracking occurs
 - The interactive flat panel behaves unexpectedly when you follow operating instructions

Contents

Important information	i
Chapter 1: Welcome	1
About your room system	2
About this guide	8
Other documentation and resources	8
Chapter 2: Preparing for your room system	11
Chapter 3: Installing your room system's hardware	13
Chapter 4: Configuring your room system's software	17
Before configuring your room system's software	18
Starting your room system for the first time	18
Logging on and configuring the displays	28
Configuring SMART Settings	30
Configuring Lync Room System software	33
Checking the status of the Lync Room System software product key	34
Testing your room system	35
Chapter 5: Using your room system	37
Scheduling meetings	37
Turning on your room system	38
Starting meetings	39
Managing meetings using the console	40
Connecting computers to your room system	42
Using the whiteboard feature	48
Supporting users with special needs	48
Ending meetings	50
Chapter 6: Maintaining your room system	51
Recommended tools	52
Remotely monitoring your room system	53
Updating software and firmware	56
Turning off your room system	57
Maintaining the interactive flat panels	59
Maintaining the console	67
Maintaining the camera	67
Maintaining the microphones	68
Maintaining the speakers	68

CONTENTS

Checking your room system cable connections	68
Checking your room system installation	68
Removing and transporting your room system	69
Chapter 7: Troubleshooting your room system	71
Resolving hardware issues	71
Resolving software issues	80
Testing your room system	82
Appendix A: Using the Lync Admin Console and SMART Settings	85
Accessing the Lync Admin Console and SMART Settings	85
Lync Admin Console controls	86
SMART Settings controls	91
Appendix B: Using the interactive flat panel on-screen display menu	95
Accessing the on-screen display menu	95
Changing settings in the on-screen display menu	96
SMART Board 8055i interactive flat panel on-screen display menu	97
SMART Board 8070i-G4 interactive flat panel on-screen display menu	102
SMART Board 8084i-G4 interactive flat panel on-screen display menu	108
Appendix C: Remotely managing your room system using Intel AMT	117
Configuring your room system	118
Remotely managing your room system	121
Security	123
Ports	123
Intel MEBx controls	124
References	128
Appendix D: Resetting the room system to factory defaults	129
Appendix E: Hardware environmental compliance	133
Waste Electrical and Electronic Equipment and Battery regulations (WEEE and Battery Directives)	133
Batteries	133
More information	133
Index	135

Chapter 1

Welcome

About your room system	2
Features	2
Integration with Lync	2
Simple startup	2
Automatic sharing of video and audio	2
Collaboration	2
Presence detection	3
Components	3
SMART Board interactive flat panels	4
Lync appliance	4
Console	4
Camera	5
Table microphones and audio processor	5
Speakers	5
Video connection harness and SMART Room System USB Bridge	5
Accessories	6
Wall stand kit	6
Additional table microphones	6
Comparing room sizes	6
About this guide	8
Other documentation and resources	8
Specifications	9
Preparation information	9
Installation instructions	9
User documentation and training	10
Knowledge base	10

This chapter introduces you to your SMART Room System™ for Microsoft® Lync® and this guide.

About your room system

Your SMART Room System features one or two SMART Board® interactive flat panels, a Lync appliance, a tabletop console, a high-definition camera, microphones, speakers and a video connection harness for use with an optional guest laptop.

Using the installed Lync Room System software, you can start a meeting and connect with other individuals or meeting rooms with a single tap on the console or the interactive flat panels. You can write or draw on the interactive flat panels using the whiteboard feature, connect an optional guest laptop to share its screen and share files with connected individuals and meeting rooms in real time.

Features

Your room system includes the following features.

Integration with Lync

The SMART Room System integrates with your organization's existing Lync infrastructure, enabling users to schedule meetings, remotely join meetings, and share Microsoft PowerPoint® files using the Lync client software already installed on their computers.

Simple startup

After the room system turns on, the console and the interactive flat panels show the meeting room's schedule, including when the meeting room is booked and when it's available. Users can start a scheduled meeting by pressing the meeting's block in the schedule on either the console or the interactive flat panels. Lync Room System software enables users to connect to remote participants and shares video and audio.

Alternatively, users can start ad hoc meetings or whiteboard sessions with a single press of the console or interactive flat panels.

Automatic sharing of video and audio

When users start or join meetings, the room system shares video and audio automatically without requiring any manual setup on the users' part. The room system's high definition camera, microphones and speakers facilitate users' communication during the meeting.

Collaboration

Using Lync Room System software's whiteboard feature, users can write or draw notes on the interactive flat panels, automatically sharing with remote participants. Users can also write or draw over PowerPoint files attached to the scheduled meeting as well as connect their laptops or a room computer to share and interact with the computers' displays.

Presence detection

Each interactive flat panel has two presence detection sensors on its frame that can detect people up to 16' (5 m) away. When the sensors detect people in the meeting room, the room system turns on. When the sensors no longer detect people in the meeting room, the room system enters Standby mode.

Components

Your room system consists of the following major components:

Part no.	Description	Room sizes
SBID 8055i	SMART Board 8055i interactive flat panel	Extra small Medium with dual panels (×2)
SBID 8070i-G4	SMART Board 8070i-G4 interactive flat panel	Small Large (×2)
SBID 8084i-G4	SMART Board 8084i-G4 interactive flat panel	Medium Extra large (×2)
AM70-L	Lync appliance	All
CP311	Console	All
CAM301	Camera	All
MIC500	Table microphones	All
MIX500	Audio processor	All
CSR500	Speakers	All
1019403	Video connection harness	All
SRS-USB Bridge	SMART Room System USB Bridge	All

 **NOTE**

Other, minor components are documented elsewhere in this guide.

SMART Board interactive flat panels

SMART Board interactive flat panels feature SMART's proprietary DViT® (Digital Vision Touch) technology on a 16:9 LCD screen with e-LED backlight. DViT technology enables users to do the following:

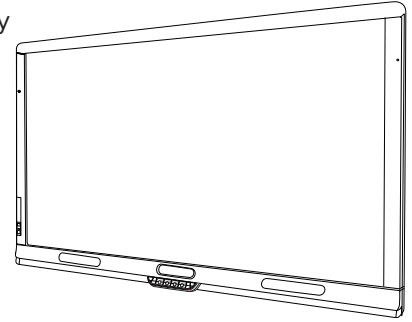

- Interact with content by pressing it with their fingers
- Write digital ink on the digital whiteboard or on a shared PowerPoint file using their fingers or one of the provided pens
- Erase digital ink using their fists, their palms or the provided eraser

During a meeting, the interactive flat panels show video, shared PowerPoint files, and video input from optionally connected laptops. In addition, users can use the whiteboard feature to record notes and share them with others.

For information on which interactive flat panel model is included with your room system and the differences between these models, see *Comparing room sizes* on page 6.

Lync appliance

The Lync appliance includes Lync Room System software as well as SMART Product Drivers. Lync Room System software enables users to start, join and facilitate meetings and connect with others through your organization's Lync infrastructure. SMART Product Drivers enables the touch features of the interactive flat panels and the operation of the all components in the room system.

In room systems with SMART Board 8055i interactive flat panels, the Lync appliance is installed in an enclosure behind the left interactive flat panel.

In room systems with SMART Board 8070i-G4 and 8084i-G4 interactive flat panels, the Lync appliance is installed in a slot on the bottom of the left interactive flat panel.

Console

The console is the room system's primary display. It enables users to access and control the features of Lync Room System software during their meetings.

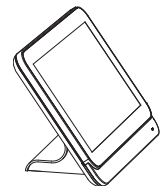

The console is typically located on the meeting room table. Like the interactive flat panels, the console features a 16:9 LCD screen with touch technology, enabling users to interact with buttons and other controls by pressing them.

Camera

The high definition camera automatically captures room video during meetings. Users can temporarily stop the video or shutter the camera for privacy purposes.

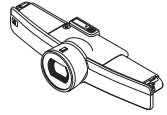

In most meeting rooms, digital pan, tilt and zoom (DPTZ) and the camera's 109° field of view ensure all meeting participants are captured regardless of where they are in the meeting room.

The camera is installed on the top of the interactive flat panel in rooms with one interactive flat panel or between the interactive flat panels in rooms with two interactive flat panels.

Table microphones and audio processor

The table microphones automatically capture audio during meetings. Users can temporarily mute the microphones for privacy purposes.

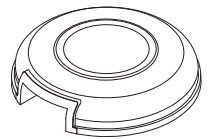

Your room system comes with two table microphones. You can purchase additional table microphones (see *Additional table microphones* on the next page).

Speakers

The speakers transmit audio from remote participants during a meeting. The room system's audio-processing features eliminate echos and in-room audio feedback.

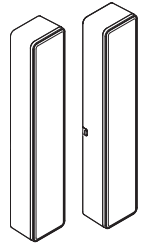

The speakers are installed on either side of the interactive flat panels.

Video connection harness and SMART Room System USB Bridge

The video connection harness and the SMART Room System USB Bridge enable users to connect their laptops or a room computer to the room system.

When users connect the video connection harness's HDMI cable or VGA cable to a computer, the computer's video output appears on an interactive flat panel and is shared with remote participants. If users also connect the SMART Room System USB Bridge to the computer, they can interact with the computer by touching the interactive flat panel's surface.

The video connection harness's and SMART Room System USB Bridge's connectors are typically located on the meeting room table.

Accessories

Accessories for the SMART Room System include the wall stand kit and additional table microphones.

NOTE

For accessory part numbers and ordering information, refer to the specifications (see *Specifications* on page 9).

Wall stand kit

The wall stand kit includes a wall stand for each interactive flat panel in your room system and the cable raceway. The wall stand transfers some of the weight from the wall to the floor and is required for metal stud walls that can't support the full weight of the interactive flat panel. The cable raceway covers cables running across the floor from the interactive flat panels to the meeting room table.

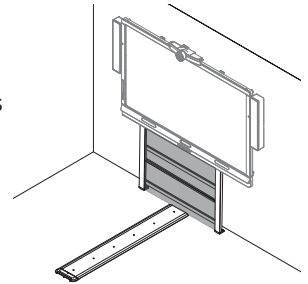

Additional table microphones

Your room system comes with two table microphones. You can purchase and connect up to three additional table microphones if needed for a total of up to five table microphones.

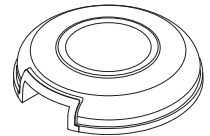

Comparing room sizes

The SMART Room System comes in six sizes. This section presents the key differences between these sizes.

Extra small room (SRS-LYNC-XS)

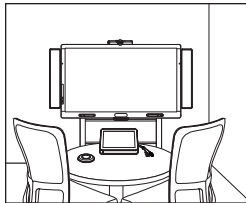

Intended use	Extra small meeting rooms (approximately four people) 75 sq. ft. (7 m ²)
Display type	One SMART Board 8055i interactive flat panel
Display size (diagonal)	54 5/8" (139 cm)
Optional wall stand kit	WSK-SINGLE

Small room (SRS-LYNC-S)

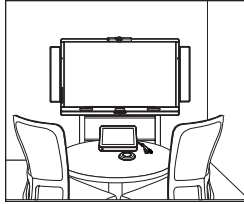

Intended use	Small meeting rooms (approximately six people) 100 sq. ft. (9 m ²)
Display type	One SMART Board 8070i-G4 interactive flat panel
Display size (diagonal)	70" (178 cm)
Optional wall stand kit	WSK-SINGLE

Medium room (SRS-LYNC-M)

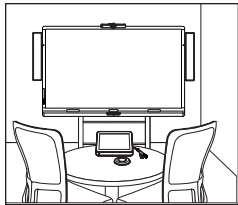

Intended use	Medium meeting rooms (approximately 12 people) 180 sq. ft. (17 m ²)
Display type	One SMART Board 8084i-G4 interactive flat panel
Display size (diagonal)	84" (213.4 cm)
Optional wall stand kit	WSK-SINGLE

Medium room with dual panels (SRS-LYNC-M-DUAL)



Intended use	Medium meeting rooms (approximately 12 people) 180 sq. ft. (17 m ²)
Display type	Two SMART Board 8055i interactive flat panels
Display size (diagonal)	2 × 54 5/8" (2 × 139 cm)
Optional wall stand kit	WSK-DUAL

Large room (SRS-LYNC-L)

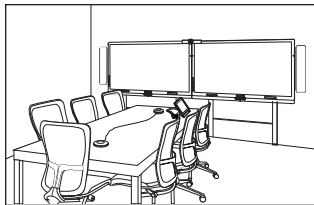

Intended use	Large meeting rooms (approximately 16 people) 300 sq. ft. (28 m ²)
Display type	Two SMART Board 8070i-G4 interactive flat panels
Display size (diagonal)	2 × 70" (2 × 178 cm)
Optional wall stand kit	WSK-DUAL

Extra large room (SRS-LYNC-XL)

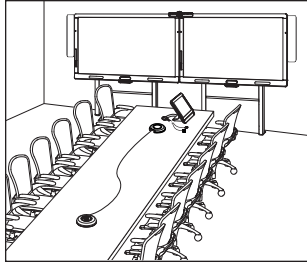

Intended use	Extra large meeting rooms (approximately 18 people) 400 sq. ft. (37 m ²)
Display type	Two SMART Board 8084i-G4 interactive flat panels
Display size (diagonal)	2 × 84" (2 × 213.4 cm)
Optional wall stand kit	WSK-DUAL

NOTE

Other, minor differences are noted throughout this guide.

About this guide

This guide explains how to set up and maintain your room system. It includes the following information:

- How to install and configure your room system
- How to use your room system's basic features
- How to maintain your room system for years of use
- How to troubleshoot issues with your room system
- How to remotely manage your room system

This guide is intended for individuals who are responsible for installing and maintaining room systems in their organizations. Other documentation and resources are available for individuals who use room systems.

Other documentation and resources

In addition to this guide, there are resources for individuals who install, maintain and use room systems.

Specifications

Your room system's specifications define the product's dimensions, weights, recommended operating and storage temperatures, power requirements and consumption and other important information for installation and maintenance.

Document	Link
<i>SMART Room System for Lync for extra small rooms specifications</i>	smarttech.com/kb/170633
<i>SMART Room System for Lync for small rooms specifications</i>	smarttech.com/kb/170449
<i>SMART Room System for Lync for medium rooms specifications</i>	smarttech.com/kb/170448
<i>SMART Room System for Lync for medium rooms with dual panels specifications</i>	smarttech.com/kb/170634
<i>SMART Room System for Lync for large rooms specifications</i>	smarttech.com/kb/170447
<i>SMART Room System for Lync for extra large rooms specifications</i>	smarttech.com/kb/170659
<i>SMART wall stand kits for SMART Board interactive flat panels specifications</i>	smarttech.com/kb/170526

Preparation information

Refer to the *SMART Room System for Microsoft Lync installation and service preparedness checklists* (knowledgebase.force.com/?q=000014425) for a comprehensive list of tools and items you need before you install your room system.

Refer to the *Microsoft Lync Room System Deployment Guide* (microsoft.com/download/confirmation.aspx?id=39274) for detailed information on provisioning the Lync room account in your organization's Lync Server and Microsoft Exchange server.

Installation instructions

Your room system comes with a hardware selection guide that explains which mounting hardware to use for your room's wall type, a quick start guide that explains how to install the room system hardware and a software configuration guide that explains how to configure the room system software. In addition, the optional wall stand and raceway include their own installation guides.

If you misplaced any of these installation instructions, you can download PDF versions.

Document	Link
<i>SMART Room System for Lync hardware selection guide</i>	smarttech.com/kb/170464
<i>SMART Room System for Lync for extra small rooms quick start guide</i>	smarttech.com/kb/170630

Document	Link
<i>SMART Room System for Lync for small rooms quick start guide</i>	smarttech.com/kb/170470
<i>SMART Room System for Lync for medium rooms quick start guide</i>	smarttech.com/kb/170467
<i>SMART Room System for Lync for medium rooms with dual panels quick start guide</i>	smarttech.com/kb/170631
<i>SMART Room System for Lync for large rooms quick start guide</i>	smarttech.com/kb/170468
<i>SMART Room System for Lync for extra large rooms quick start guide</i>	smarttech.com/kb/170658
<i>SMART Room System for Lync software configuration guide</i>	smarttech.com/kb/170608
<i>SMART wall stand for SMART Board interactive flat panels installation guide</i>	smarttech.com/kb/170466
<i>SMART cable raceway for SMART Room Systems installation guide</i>	smarttech.com/kb/170465
<i>SMART Room System for Lync table microphone upgrade kit installation guide</i>	smarttech.com/kb/170560

 **NOTE**

The software configuration guide contains the same information as *Preparing for your room system* on page 11 and *Configuring your room system's software* on page 17.

User documentation and training

Lync Meeting Room software includes a tutorial that explains how to use the software. To open the tutorial, press the **Open Tutorial** button on the interactive flat panels.

The SMART training website (smarttech.com/trainingforbusiness) includes an extensive library of training resources you can refer to when learning how to use your room system.

Knowledge base

The Support center (smarttech.com/support) includes a knowledge base that you can refer to when performing maintenance on your room system or troubleshooting issues with your room system.

The knowledge base includes the *SMART Room System for Microsoft Lync troubleshooting decision tree* (knowledgebase.force.com/?q=000014411), which you can refer to when troubleshooting the room system.

Chapter 2

Preparing for your room system

Several weeks before installing your room system's hardware and configuring its software, complete the following tasks.

✓	Task
	Ensure you have all items documented in the <i>SMART Room System for Microsoft Lync installation and service preparedness checklists</i> (see <i>Preparation information</i> on page 9).
	Ensure your organization has implemented Lync 2013 and the Lync infrastructure is functioning.
	Download and follow the instructions in the <i>Microsoft Lync Room System Deployment Guide</i> (see <i>Preparation information</i> on page 9). This guide explains how to provision the Lync account in the Lync Server and the Microsoft Exchange server.
	Use a test computer to confirm that the Lync account is functioning.
	Determine if your Lync infrastructure includes a key management service (KMS) server and if the KMS server is configured to provide Lync 2013 product keys. A KMS server automatically provides a product key to the Lync Room System software. If your Lync infrastructure doesn't include a KMS server, you can use the multiple activation key (MAK) provided by Microsoft during the configuration of the software.

Chapter 3

Installing your room system's hardware

This chapter is intended for installers. Before they install the room system's hardware, installers should read this chapter along with the hardware installation instructions (see *Installation instructions* on page 9) included with the room system.



WARNING

Improper installation of your room system's hardware can result in personal injury and product damage.

Before installing your room system's hardware, do the following.

✓	Task
	Review the room temperature and humidity requirements in the room system's specifications (see <i>Specifications</i> on page 9).
	Save all product packaging so that it's available if you need to transport the room system at a later date.  NOTE If the original packaging isn't available, you can purchase new product packaging from your authorized SMART reseller (smartechnology.com/where).

✓	Task																					
	<p>Ensure the wall can support the weight of the room system.</p> <table border="1" style="width: 100%; border-collapse: collapse;"> <thead> <tr> <th style="text-align: left;">Room</th> <th style="text-align: center;">Weight (lb.)</th> <th style="text-align: center;">Weight (kg)</th> </tr> </thead> <tbody> <tr> <td>Extra small</td> <td style="text-align: center;">151</td> <td style="text-align: center;">68.5</td> </tr> <tr> <td>Small</td> <td style="text-align: center;">254</td> <td style="text-align: center;">115.6</td> </tr> <tr> <td>Medium</td> <td style="text-align: center;">326</td> <td style="text-align: center;">148.5</td> </tr> <tr> <td>Medium with dual panels</td> <td style="text-align: center;">273</td> <td style="text-align: center;">124</td> </tr> <tr> <td>Large</td> <td style="text-align: center;">487</td> <td style="text-align: center;">221</td> </tr> <tr> <td>Extra large</td> <td style="text-align: center;">615</td> <td style="text-align: center;">279</td> </tr> </tbody> </table>	Room	Weight (lb.)	Weight (kg)	Extra small	151	68.5	Small	254	115.6	Medium	326	148.5	Medium with dual panels	273	124	Large	487	221	Extra large	615	279
Room	Weight (lb.)	Weight (kg)																				
Extra small	151	68.5																				
Small	254	115.6																				
Medium	326	148.5																				
Medium with dual panels	273	124																				
Large	487	221																				
Extra large	615	279																				
	<div style="background-color: #f0f0f0; padding: 10px;"> <p> NOTES</p> <ul style="list-style-type: none"> • Refer to local building codes to confirm that the wall can support the above weights. • Refer to the hardware selection guide for the recommended hardware for your wall type (see <i>Installation instructions</i> on page 9). </div>																					
	<p>Choose an appropriate location for the room system:</p> <ul style="list-style-type: none"> • Do not install the room system in a location where a door or gate could hit it. • Do not install the room system in an area where it will be subjected to strong vibrations or dust. • Do not install the room system where the main power supply enters the building. • Ensure adequate ventilation or provide air conditioning around the room system so that heat can flow away from the unit and the mounting equipment. • If you mount the room system in a recessed area, leave at least 4" (10 cm) of space between the room system and the recessed walls to enable ventilation and cooling. • Ensure the room lighting is adequate for the camera to capture video. To prevent participants from appearing darkened or shadowed in video, ensure they aren't backlit. 																					
	<p>Install the room system so that its center aligns with the center of the meeting room table. This ensures the meeting room table appears in the center of the camera's field of view.</p>																					

✓	Task		
	Install the room system so that the interactive flat panels are the appropriate distance from the floor.		
	Room	From the floor to the bottom of the interactive flat panel	From the floor to the bottom of the active display area
	Extra small	37" (94 cm)	40" (101.6 cm)
	Small	32" (81.4 cm)	38 1/8" (97 cm)
	Medium	29 1/2" (74.9 cm)	35 3/8" (89.9 cm)
	Medium with dual panels	37" (94 cm)	40" (101.6 cm)
	Large	32" (81.4 cm)	38 1/8" (97 cm)
	Extra large	29 1/2" (74.9 cm)	35 3/8" (89.9 cm)
	If you want to use third-party hardware with your room system, see <i>Using hardware not provided by SMART with your SMART Room System for Microsoft Lync</i> (knowledgebase.force.com/?q=15294).		

Chapter 4

Configuring your room system's software

Before configuring your room system's software	18
Starting your room system for the first time	18
Starting your room system	18
Configuring Lync Room System software first-run installation settings	27
Logging on and configuring the displays	28
Configuring SMART Settings	30
Configuring Lync Room System software	33
Checking the status of the Lync Room System software product key	34
Testing your room system	35

After completing the hardware installation, you must start the room system for the first time and then configure its software.



IMPORTANT

This chapter is intended for IT administrators responsible for configuring the room system's software.



NOTE

In addition to configuring the room system's software, you can enable and use Intel® Active Management Technology (AMT) to remotely manage the room system. For more information, see *Remotely managing your room system using Intel AMT* on page 117.

Before configuring your room system's software

Before configuring your room system's software, ensure the following prerequisites are in place:

✓	Task
	The steps in <i>Preparing for your room system</i> on page 11 have been completed.
	<p>You have the necessary information to connect the room system to the Lync Server, including the following:</p> <ul style="list-style-type: none">• IP addresses for DNS servers (if not configured automatically from the network via DHCP)• Administrator user name and password to be applied to the room system• Lync appliance computer name for network presence• Lync account name and password for the room system• SIP URI address <p> TIP You can record this information in the <i>SMART Room System for Microsoft Lync software configuration guide</i> for future reference.</p>
	A USB mouse and keyboard are connected to the Lync appliance for use during the software configuration.

Starting your room system for the first time

Starting your room system

The procedure for starting your room system depends on the room size.

Room size	Procedure
Extra small room	Page 19
Small room	Page 19
Medium room	Page 20
Medium room with dual panels	Page 22
Large room	Page 23
Extra large room	Page 24

To start your extra small room system

1. Flick the power switch on the bottom of the interactive flat panel.

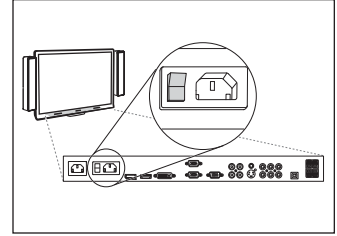

2. Press the **Input Select** button  on the interactive flat panel's front control panel until the input source is *HDMI1*.

The Lync appliance begins the first-run installation process. During this process, the Lync appliance restarts several times.

NOTE

This process takes time to complete. During this process, displays might not change content or might appear blank for several minutes.

3. Press **MENU** on the interactive flat panel's remote control.
4. Press the down arrow until you select the *SETUP* menu, and then press **SET**.
5. Press the down arrow until you select *USB SETTING*, and then press the right arrow.
6. Press the left or right arrow until the *USB1* option is *HDMI1*.
7. Press **MENU** or **EXIT** until the on-screen display menu closes.
8. Continue to *Configuring Lync Room System software first-run installation settings* on page 27.

To start your small room system

1. Flick the power switch on the bottom of the interactive flat panel.

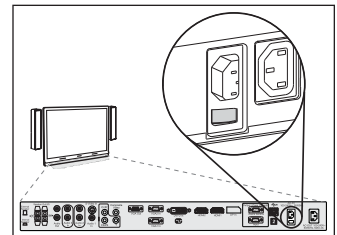

2. Press the **Input Select** button  on the interactive flat panel's front control panel until the input source is *HDMI3/PC*.

The Lync appliance begins the first-run installation process. During this process, the Lync appliance restarts several times.

 **NOTE**

This process takes time to complete. During this process, displays might not change content or might appear blank for several minutes.

3. Press **MENU** on the interactive flat panel's remote control.
4. Press the down arrow until you select the *SETUP* menu, and then press **SET**.
5. Press the down arrow until you select *Lync® ROOM RESET*, and then press the right arrow.
The on-screen display menu blinks briefly.
6. Press **MENU** or **EXIT** until the on-screen display menu closes.

 **NOTE**

Completing steps 3 to 6 configures the interactive flat panel's USB-video mapping, audio settings, presence detection settings and other settings for use with the SMART Room System. In addition, completing the above steps disables the volume and input select controls on the interactive flat panel's front control panels.

7. Continue to *Configuring Lync Room System software first-run installation settings* on page 27.

To start your medium room system

1. Flick the power switch on the bottom of the interactive flat panel.

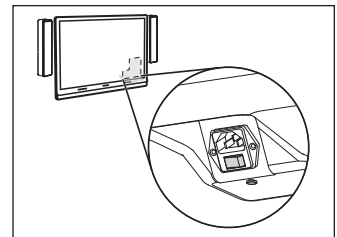

2. Press the **Input Select** button  on the interactive flat panel's front control panel until the input source is *HDMI3/PC*.

The Lync appliance begins the first-run installation process. During this process, the Lync appliance restarts several times.

 **NOTE**

This process takes time to complete. During this process, displays might not change content or might appear blank for several minutes.

3. Press **MENU** on the interactive flat panel's remote control.
4. Press the down arrow until you select the *OPTION* menu, and then press **OK**.
5. Press the down arrow until you select *Lync® Room Reset*, and then press **OK**.
6. Press the left arrow to select *Reset*, and then press **OK**.

 **NOTE**

Completing steps 3 to 6 configures the interactive flat panel's USB-video mapping, audio settings, presence detection settings and other settings for use with the SMART Room System. In addition, completing the above steps disables the volume and input select controls on the interactive flat panel's front control panel.

7. Set the Lync appliance input's operating mode to **PC**:
 - a. Press **INPUT**, and then press the red button on the remote control, which is below the **BACK** button.
*The **Input Label** menu appears.*
 - b. Using the left and right arrow buttons, select **HDMI3/PC**, and then press **OK**.
 - c. Using the left, right, up and down arrow buttons, select **PC**, and then press **OK**.
 - d. Press the down arrow to select **Close**, and then press **OK**.

In the *Input List* menu, the computer input's icon indicates that its operating mode is **PC**.

 **IMPORTANT**

If you do not complete these steps, the following could occur:

- The interactive flat panel might not display the outer edges of the Lync appliance's display.
- Users might notice higher than normal video display latency.

 **NOTE**

These steps are also documented in *Before you configure your SMART Board 8084i-G4 interactive flat panel* (smarttech.com/kb/170597), which is included with your room system.

8. Set the options in the *PICTURE* menu as per SMART's recommendations (see *SMART Board 8084i-G4 interactive flat panel on-screen display menu* on page 108).
9. Continue to *Configuring Lync Room System software first-run installation settings* on page 27.

 **To start your medium room system with dual panels**

1. Flick the power switch on the bottom of the right interactive flat panel.

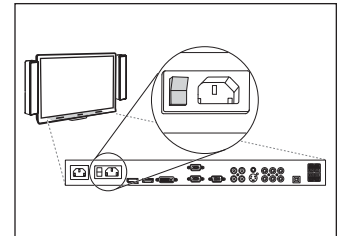

2. Press the **Input Select** button  on the right interactive flat panel's front control panel until the input source is *HDMI1*.

3. Flick the power switch on the bottom of the left interactive flat panel.

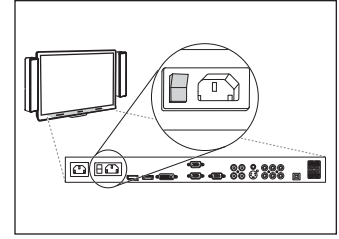

4. Press the **Input Select** button  on the left interactive flat panel's front control panel until the input source is *HDMI1*.

The Lync appliance begins the first-run installation process. During this process, the Lync appliance restarts several times.

 **NOTE**

This process takes time to complete. During this process, displays might not change content or might appear blank for several minutes.

5. Press **MENU** on the left interactive flat panel's remote control.
6. Press the down arrow until you select the *SETUP* menu, and then press **SET**.
7. Press the down arrow until you select *USB SETTING*, and then press the right arrow.
8. Press the left or right arrow until the *USB1* option is *HDMI1*.
9. Press **MENU** or **EXIT** until the on-screen display menu closes.
10. Repeat steps 5 to 9 for the right interactive flat panel.
11. Continue to *Configuring Lync Room System software first-run installation settings* on page 27.

 **To start your large room system**

1. Flick the power switch on the bottom of the right interactive flat panel.

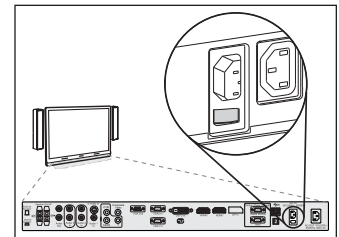

2. Press the **Input Select** button  on the right interactive flat panel's front control panel until the input source is *HDMI3/PC*.

3. Flick the power switch on the bottom of the left interactive flat panel.

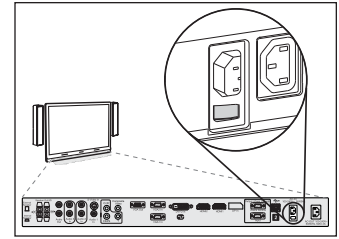

4. Press the **Input Select** button  on the left interactive flat panel's front control panel until the input source is *HDMI3/PC*.

The Lync appliance begins the first-run installation process. During this process, the Lync appliance restarts several times.

 **NOTE**

This process takes time to complete. During this process, displays might not change content or might appear blank for several minutes.

5. Press **MENU** on the left interactive flat panel's remote control.
6. Press the down arrow until you select the *SETUP* menu, and then press **SET**.
7. Press the down arrow until you select *Lync® ROOM RESET*, and then press the right arrow.
The on-screen display menu blinks briefly.
8. Press **MENU** or **EXIT** until the on-screen display menu closes.
9. Repeat steps 5 to 8 for the right interactive flat panel.

 **NOTE**

Completing steps 5 to 9 configures the interactive flat panels' USB-video mapping, audio settings, presence detection settings and other settings for use with the SMART Room System. In addition, completing the above steps disables the volume and input select controls on the interactive flat panels' front control panels.

10. Continue to *Configuring Lync Room System software first-run installation settings* on page 27.

To start your extra large room system

1. Flick the power switch on the bottom of the right interactive flat panel.

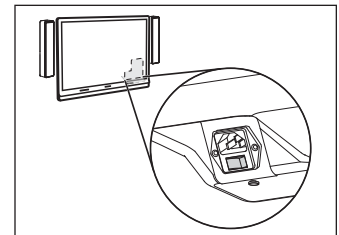

2. Press the **Input Select** button  on the right interactive flat panel's front control panel until the input source is *HDMI3/PC*.

3. Flick the power switch on the bottom of the left interactive flat panel.

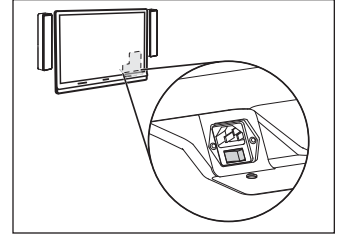

4. Press the **Input Select** button  on the left interactive flat panel's front control panel until the input source is *HDMI3/PC*.

The Lync appliance begins the first-run installation process. During this process, the Lync appliance restarts several times.



NOTE

This process takes time to complete. During this process, displays might not change content or might appear blank for several minutes.

5. Press **MENU** on the left interactive flat panel's remote control.
6. Press the down arrow until you select the *OPTION* menu, and then press **OK**.
7. Press the down arrow until you select *Lync® Room Reset*, and then press **OK**.
8. Press the left arrow to select *Reset*, and then press **OK**.

9. Set the Lync appliance input's operating mode to **PC**:
 - a. Press **INPUT**, and then press the red button on the remote control, which is below the **BACK** button.

The *Input Label* menu appears.
 - b. Using the left and right arrow buttons, select **HDMI3/PC**, and then press **OK**.
 - c. Using the left, right, up and down arrow buttons, select **PC**, and then press **OK**.
 - d. Press the down arrow to select **Close**, and then press **OK**.

In the *Input List* menu, the computer input's icon indicates that its operating mode is **PC**.



IMPORTANT

If you do not complete these steps, the following could occur:

- The interactive flat panel might not display the outer edges of the Lync appliance's display.
- Users might notice higher than normal video display latency.



NOTE

These steps are also documented in *Before you configure your SMART Board 8084i-G4 interactive flat panel* (smarttech.com/kb/170597), which is included with your room system.

10. Set the options in the *PICTURE* menu as per SMART's recommendations (see *SMART Board 8084i-G4 interactive flat panel on-screen display menu* on page 108).
11. Repeat steps 5 to 10 for the right interactive flat panel.



NOTE

Completing steps 5 to 10 configures the interactive flat panels' USB-video mapping, audio settings, presence detection settings and other settings for use with the SMART Room System. In addition, completing the above steps disables the volume and input select controls on the interactive flat panels' front control panels.

12. Continue to *Configuring Lync Room System software first-run installation settings* on the next page.

Configuring Lync Room System software first-run installation settings

To configure Lync Room System software first-run installation settings

1. Select your language, and then click **Next**.
2. Select your country or region, time and currency preference, and keyboard layout, and then click **Next**.
3. Type a user name for the administrator account and a computer name for the Lync appliance, and then click **Next**.

You must provide the administrator account's user name and password whenever you change the room system's configuration or troubleshoot issues. The administrator account is only for use with your SMART Room System and is not mapped or otherwise associated with user accounts on your network.

In most configurations, the administrator's user name is "admin".



IMPORTANT

- You must type a user name for the administrator account in the *Type a user name* box. Do not leave this box blank.
- Do not use "LyncRoom" for the administrator account's user name because this user name is reserved.

4. Type a password for the administrator's account and a hint for that password, and then click **Next**.



IMPORTANT

- You must type a password for the administrator account in the *Type a password* box. Do not leave this box blank.
- Do not use special characters in the password that require the use of the ALT key to type.
- If you forget the administrator account's user name and password, you are unable to reset them without resetting the room system to the factory image and then configuring the software again.

Therefore, record the administrator account's user name and password in the *SMART Room System for Microsoft Lync software configuration guide* or in another safe place.

5. Select your time zone, specify the current date and time, and then click **Next**.



IMPORTANT

You must specify the correct date and time. If the room system's date and time are different than the Lync and Microsoft Exchange servers' dates and times, the room system is unable to connect to the servers.

The Lync appliance restarts several times. When the basic configuration process is complete, a screen prompting for the administrator account's password appears.



NOTE

After the Lync appliance shuts down and starts again for the first time, it might prompt you for a password or it might log in by itself. In either case the Lync appliance will shut down and start again.

6. Continue to the next procedure.

Logging on and configuring the displays

To log on and configure the displays

1. Type the room system administrator account's password, and then press ENTER.

The SMART end user license agreement appears.

2. Read the SMART end user license agreement, and then click **Accept**.

The *Conferencing Microphone Configuration* dialog box appears.

3. Select **Use the table microphone**, and then click **OK**.



IMPORTANT

You are unable to change this setting later, so ensure you select the correct option.

The *First things first* dialog box and a dialog box prompting you to check the display settings appear.

4. In the *First things first* dialog box, select **Use recommended settings**, and then click **Accept**.

5. In the dialog box prompting you to check the display settings, click **OK**.

Another dialog box appears, and Control Panel opens.

Configuring SMART Settings

To configure SMART hardware

1. Click **OEM Settings**, and then click **SMART Settings**.

SMART Settings appears.

2. Click **SMART Room System Settings**.

3. Define your organization's business hours by doing the following:

- a. If your organization's business day is 12 hours, select **12 Hour Setting**, and then select the appropriate time frame in the drop-down list.

OR

If your organization's business day is not 12 hours, select **Custom Setting**, and then select the start and end times for your organization's business day.

- b. Select the days of the week your organization operates.



NOTE

Your room system enters power saving mode outside of the business hours you define in this screen.

4. Click **SMART Hardware Settings**.
5. Confirm that all components of your room system are listed on this screen. If a component isn't listed, ensure the component is properly connected to the Lync appliance.
6. Continue to the next procedure.

To calibrate and orient touch on the interactive flat panels

1. If SMART Settings isn't open from the previous procedure, click **OEM Settings**, and then click **SMART Settings**.

SMART Settings appears.

2. Click **Connection Wizard**.

The *SMART Connection* wizard appears. The wizard detects your room system's SMART interactive products.

3. Select the first interactive flat panel in the list, and then click **Next**.
4. Select **Product is being set up for the first time**, and then click **Next**.

5. Click **Calibrate**.

The calibration screen appears on the console.



6. Move the calibration screen to the selected interactive flat panel by pressing the spacebar on the keyboard or the **Orient** button  on the interactive flat panel's color select module.

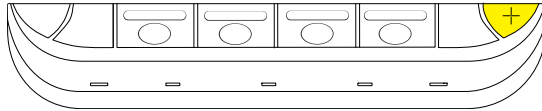

NOTE

If you're configuring a room system with two interactive flat panels, you need to determine which interactive flat panel you selected in step 3. To do this, attempt to complete step 7 on the interactive flat panel you moved the calibration screen to. If the calibration screen doesn't respond to touch on this interactive flat panel, move the calibration screen to the other interactive flat panel and then repeat step 7.

7. Calibrate the interactive flat panel by following the on-screen instructions.

The orientation screen appears on the selected interactive flat panel.

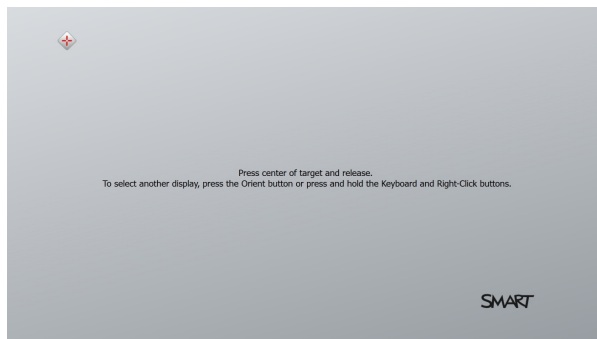

8. Orient the interactive flat panel by following the on-screen instructions.



NOTE

If you touch a target in either the calibration screen or the orientation screen but aren't advanced to the next target, press the spacebar or the **Orient** button  to move to the next interactive flat panel and try again.

9. Click **Next**, and then click **Finish**.
10. If you're configuring a room system with two interactive flat panels, repeat steps 2 to 9 for the second interactive flat panel.



NOTE

You don't need to calibrate or orient the console.

11. Continue to the next procedure.

To optimize the camera

1. If SMART Settings isn't open from the previous procedure, click **OEM Settings**, and then click **SMART Settings**.

SMART Settings appears.

2. Click **SMART Hardware Settings**.
3. Click the camera's icon.
4. Click **Preview**.

The *Camera Configuration* window opens.

5. Select the mains power line frequency for your country (50 Hz or 60 Hz), set the pan, tilt and zoom as appropriate for the meeting room's size, and then click **OK**.



NOTE

Digital pan and tilt options are available only when the camera is zoomed in.

6. Click **OK**.
- SMART Settings closes.
7. Continue to the next procedure.

Configuring Lync Room System software

NOTE

The following procedure documents SMART's recommended configuration of Lync Room System software for a typical Lync infrastructure setup. Refer to the *Microsoft Lync Room System Deployment Guide* for detailed deployment information (see *Preparation information* on page 9).

To configure Lync Room System software

1. Click **Lync Settings**, and then set the following controls:

Control	Procedure
Credentials	
• User Name	Type the Lync account's full domain name in one of two formats depending on how your organization's servers are configured (for example, yourdomain\room1 or room1@yourdomain.com).
• SIP URI	Type the Lync account's SIP URI (for example, room1@yourdomain.com).
NOTE If the domain name used in the Lync account's SIP URI is different from the domain name on the Lync Web Service certificate, see <i>Adding trusted domains to your room system</i> on page 81.	
• Password	Type the Lync account's password.
Proxy Credentials	Select Use Lync Account credentials .
Configuration Modes	If your organization maintains a mixed environment of Lync 2010 and Lync 2013 server pools, select Manual , and then type the address of the Lync 2013 server pool in the <i>Internal Server Name</i> box.
Quality Control	Optionally, enable the Customer Experience Program to assist with troubleshooting.
Logging	Optionally, select Full in the drop-down list, and then enable Windows® Event Logging to assist with troubleshooting.

TIP

You can record this information in the *SMART Room System for Microsoft Lync software configuration guide* for future reference.

2. Click **System Settings**, and then click **Network Connections**.

The *Network Connections* window opens.

3. Right-click **Local Area Connection**, and then select **Properties**.

The *Local Area Connection Properties* dialog box appears.

4. Select **Internet Protocol Version 4 (TCP/IPv4)**, and then click **Properties**.

The *Internet Protocol Version 4 (TCP/IPv4) Properties* dialog box appears.

5. Select **Obtain DNS server address automatically**.

OR

Select **Use the following DNS server addresses**, and then type your domain's DNS server addresses in the *Preferred DNS server* and *Alternate DNS server* boxes.

6. Select **Validate settings upon exit**, and then click **OK**.

7. Close the *Local Area Connection Properties* dialog box, and any other open windows and dialog boxes.

8. Click **Password Renewal**, and then disable **Auto-Renew Password**.

9. Continue to the next procedure.

Checking the status of the Lync Room System software product key

■ To check the status of the product key in version 15.05 or earlier of Lync Room System software

1. Click **OEM Settings**, and then click **SRS Licensing Tool**.
2. Click **Check Status**.

If your organization has a Lync Room System software product key distributed by a KMS server, the *Status* box indicates that the room system is licensed. Otherwise, the *Status* box indicates that the room system isn't licensed.



NOTE

Depending on the KMS server's settings, the KMS server might take several hours to allocate a product key to the room system.

3. If the room system is licensed, continue to the next procedure.

OR

If the room system isn't licensed, do one of the following:

- Wait for the KMS server to allocate a product key to the room system, and then repeat steps 1 to 2.

 **NOTE**

You can continue using the Lync Room System software during the trial period.

- Type the MAK provided by Microsoft in the *MAK* key box, click **Activate Key**, and then continue to *Testing your room system* below.

 **To check the status of the product key in version 15.06 or later of Lync Room System software**

1. Click **Lync License**.

If your organization has a Lync Room System software product key distributed by a KMS server, the *Status* box indicates that the room system is licensed. Otherwise, the *Status* box indicates that the room system isn't licensed.

2. If the room system is licensed, continue to the next procedure.

OR

If the room system isn't licensed, do one of the following:

- Wait for the KMS server to allocate a product key to the room system, and then repeat step 1.

 **NOTE**

You can continue using the Lync Room System software during the trial period.

- Select **Multiple Activation Key (MAK)**, type the MAK provided by Microsoft in the *Enter a key* box, click **Activate Key**, and then continue to *Testing your room system* below.

Testing your room system

 **To test your room system**

1. Click **Lync Settings**.
2. If your organization uses an on-premise Lync Server, click **Make a Test Call**, and then follow the on-screen instructions to test call functions.

3. Click **Test Meet Now**, and then follow the on-screen instructions to test server connections and video functions.
4. If you're unable to complete a test call or test meeting, wait one or two minutes and then try steps 2 and 3 again.



TIPS

- If you're still unable to complete a test call or test meeting, you can verify the room system's Lync account credentials by using them on a computer with Lync 2013 client software.
- If the audio is too loud or too quiet, adjust the audio settings in the *Lync Settings* tab.

5. Click **Apply & Restart**.

The Lync appliance restarts in meeting mode:

- When the room system connects to the Microsoft Exchange server, the meeting room's calendar appears.
- When the room system connects to the Lync Server, the meeting room name and the *Meet Now* button appear below the calendar.



NOTE

If the Lync appliance starts in administrator mode, click **Apply & Restart** again to shut down and start the Lync appliance in meeting mode.



TIPS

- If the Lync appliance is unable to connect to the Lync Server, use a computer with Lync 2013 client software to verify the Lync account credentials.
- If the Lync appliance is unable to connect to the Microsoft Exchange server, use a computer with an Internet browser to log on to Microsoft Outlook® Web Access with the Lync account credentials. This enables you to verify that the Lync account can access the Microsoft Exchange calendar.

Chapter 5

Using your room system

Scheduling meetings	37
Turning on your room system	38
Starting meetings	39
Managing meetings using the console	40
Connecting computers to your room system	42
Installing software for the SMART Room System USB Bridge	42
Connecting a guest laptop using the video connection harness and SMART Room System USB Bridge	43
Connecting a guest laptop using Lync client software	44
Connecting a room computer	44
Orienting touch	46
Using the whiteboard feature	48
Supporting users with special needs	48
Ending meetings	50

This chapter provides an overview of how users can schedule and conduct a meeting using your SMART Room System and Lync Room System software.

Scheduling meetings

Using Microsoft Outlook on their personal computers, users can schedule Lync meetings and book the SMART Room System as a resource.

To schedule a new Lync meeting

1. Start Outlook, and then click **Calendar**.
2. Click **Home**, and then click **New Lync Meeting**.



NOTE

For users with older versions of Lync software, this button is labeled *New Online Meeting*.

A new Lync meeting opens.

3. Select a date and time for the meeting, type a subject and details, and then add participants and the room resource.
4. If appropriate, change the meeting options:
 - a. Click **Meeting Options**.
The *Lync Meeting Options* dialog box appears.
 - b. Change the meeting options.

 **NOTE**
The controls in this dialog box vary depending on how your organization has configured Lync Server.
 - c. Click **OK**.
5. Send the meeting invitation to the participants and resources.

To convert an existing meeting to a Lync meeting

1. Start Outlook, and then click **Calendar**.
2. Locate the meeting in the calendar, and then double-click it.
The meeting opens.
3. Click **Appointment**, and then click **Lync Meeting**.



NOTE

For users with older versions of Lync software, this button is labeled *Online Meeting*.

4. Add the room system as a resource.
5. Send the meeting update to the participants and resources.

Turning on your room system

Your room system's interactive flat panels have two presence detection sensors on their frames that can detect people up to 16' (5 m) away when the room system is in Standby mode.

When the sensors detect motion in the room, the room system turns on. If presence detection is disabled, you can manually turn on the room system by pressing the **Power/Standby** button  on the front control panel of each interactive flat panel.

Starting meetings

After the room system turns on, the interactive flat panels and the console show the room system's schedule as a set of squares:

- When the room system is booked for a meeting, the meeting's details and *Join* appear in the square.
- When the room system is available, *Free* appears in the square.

NOTE

If the room system's schedule doesn't appear or update correctly, there might be an issue with the connection between the Lync Room System software and Microsoft Exchange server (see *Resolving software issues* on page 80).

Users can join a scheduled meeting when the room system is booked, or they can create an ad hoc meeting when the room system is available.

To join a scheduled meeting

1. Press the meeting's square on either the interactive flat panels or the console.

NOTE

The schedule shows only the Lync meetings to which the room system has been added as a resource. If a meeting doesn't appear as a square in the schedule, convert the meeting to a Lync meeting and add the room system to the meeting as a resource (see *Scheduling meetings* on page 37).

2. If the meeting is private, type the appropriate sign-in address, user name and password in the text boxes, and then click **Join**.

The console shows a set of tabs for managing the meeting (see *Managing meetings using the console* on the next page). The interactive flat panels show up to five connected participants' videos in a gallery.

To create an ad hoc meeting

1. Press **Meet Now** on the console.
2. Add participants to the meeting.

3. Press **Start Meeting**.

The console shows a set of tabs for managing the meeting (see *Managing meetings using the console* below). The interactive flat panels show connected participants' videos in a gallery.



TIP

Alternatively, if the Lync infrastructure supports connecting through POTS, press **Dial Pad** and use the dial pad to call a person using the room system. To convert the audio call into a video meeting, press **Start Video** and then press **Invite More People**.

Managing meetings using the console

The console enables users to manage the meeting and the room system features. The user who organized the meeting typically sits in front of and operates the console during the meeting.

During the meeting, users can show and use the following tabs on the console:

Tab	Contents	Actions
Content	The name of the participant who is currently presenting and the content uploaded to the meeting including PowerPoint files and whiteboard sessions	<ul style="list-style-type: none">• Press a content item, and then click Start Presenting to present the item.• Press Stop Presenting when done.
Participants	A list of participants in the meeting <div data-bbox="565 1247 888 1486"><p>NOTE If there are more than 30 participants in the meeting, the list of participants doesn't appear.</p></div>	<ul style="list-style-type: none">• Press a participant's name and then select the appropriate option from the menu:<ul style="list-style-type: none">◦ Mute and unmute the participant's audio◦ Pin the participant's video to the gallery so that it's always visible◦ Lock or unlock the spotlight on the participant◦ Remove the participant from the meeting• Press Invite More People to invite additional participants.• Press Mute Audience to mute all participants' audio except for the participant who is currently presenting.

Tab	Contents	Actions
Display	Display options for the room system's interactive flat panels	<ul style="list-style-type: none"> • In room systems with one interactive flat panel, select from one of the following options: <ul style="list-style-type: none"> ◦ Gallery & Content to show the gallery and shared content ◦ Gallery to show only the gallery ◦ Presentation to show only shared content ◦ Speaker to show only the presenting participant's video ◦ Speaker & Content to show the presenting participant's video and shared content • In room systems with two interactive flat panels, select from one of the following options: <ul style="list-style-type: none"> ◦ Gallery & Content to show the gallery on one interactive flat panel and shared content on the other interactive flat panel ◦ Speaker to show the presenting participant's video on one interactive flat panel and shared content on the other interactive flat panel ◦ Gallery View to show the gallery across both interactive flat panels • Enable Preview to show the video from the room system camera.
IM	Instant messages (IMs) shared during the meeting	Press the input field and then use the on-screen keyboard to type an IM. All participants in the meeting can see all IMs.

In addition to the tabs, the console contains a toolbar with the following buttons:

Button	Procedure
Stop Video	Stop the meeting room's video.
Hold Call	Stop the meeting's video and mute the audio.
Mute Room	Mute the meeting room's microphones.
Speaker Off	Mute the meeting room's speakers.
Room Volume	Move the slider to adjust the volume.

Button	Procedure
Dial Pad	Show a dial pad to use Lync Room System software's phone features (if the Lync infrastructure supports a POTS bridge).
New Whiteboard	Create a new whiteboard file.
Email Whiteboard	E-mail the whiteboard file.
Leave Meeting	Disconnect the room system from the Lync meeting (see <i>Ending meetings</i> on page 50).

Connecting computers to your room system

Users can connect the room system to a guest laptop (on a temporary basis) or to a room computer (on a permanent basis) to share the computer display during a meeting.

NOTE

Remote participants connecting to the meeting through some smart phones and other mobile devices are unable to view shared computer displays due to limitations of the Lync client software for those devices.

Installing software for the SMART Room System USB Bridge

SMART recommends that you install the following (or later) versions of SMART Meeting Pro® PE software, SMART Ink™ and SMART Product Drivers on all computers you intend to connect to your SMART Room System using the SMART Room System USB Bridge:

Software	Windows operating systems	Mac OS X operating system software
SMART Meeting Pro PE software	1.2.206.0	1.2.166.0
SMART Ink	2.2.366.0	2.2.276.0
SMART Product Drivers	11.6.1019.0	11.6.1033.1

This software enables you to take full advantage of the interactive flat panels' features, to interact with applications by touching them and to write or draw digital ink over content.

IMPORTANT

If you have a Mac computer, you must install SMART Product Drivers to use your computer with the SMART Room System USB Bridge.

To download and install the latest versions of SMART software

1. Go to smarttech.com/downloads.
2. Click **Choose a version** under *SMART Meeting Pro PE (Personal Edition) software*, and then select the most recent version for your operating system.
3. Click **Download**, and then save the installer to a temporary location on your computer.
4. Double-click the installer.
5. Follow the on-screen instructions to install SMART software.

Connecting a guest laptop using the video connection harness and SMART Room System USB Bridge

If the video connection harness isn't connected to a room computer (see *Connecting a room computer* on the next page), users can use the harness to connect their laptops and share their displays.

If the room system has a SMART Room System USB Bridge and Lync Room System software 15.11, users can also connect the SMART Room System USB Bridge to their laptops to enable interaction from an interactive flat panel.

To share a guest laptop's display using the video connection harness

1. Connect the guest laptop to the room system using the video connection harness's HDMI cable or VGA cable.
2. If the console prompts you to share the display, press **Yes**.
3. Disconnect the video connection harness's HDMI cable or VGA cable from the laptop when you're done.

To share a guest laptop's display and enable interaction from an interactive flat panel

1. Set up your laptop as described in *Installing software for the SMART Room System USB Bridge* on the previous page.
2. Connect the guest laptop to the room system using the video connection harness's HDMI cable or VGA cable and the SMART Room System USB Bridge.
3. If the console prompts you to share the display, press **Yes**.
4. If necessary, orient touch (see *Orienting touch* on page 46).
5. Disconnect the video connection harness's HDMI cable or VGA cable and the SMART Room System USB Bridge from the laptop when you're done.

Connecting a guest laptop using Lync client software

Users can also share their laptop's displays by joining a meeting using Lync client software on the laptop.

If a user shares a PowerPoint file during a Lync meeting, other users can write on the shared PowerPoint file

To connect a guest laptop

1. Join the meeting on the laptop using Lync client software.
2. If you're joining the meeting in person, press **Yes** when prompted to confirm you're in the meeting room.

OR

If you're joining the meeting remotely, press **No** when prompted to confirm you're not in the meeting room.

To write or draw on a shared PowerPoint file

1. Connect a guest laptop (see *To connect a guest laptop* above).
2. Click **Presentation** , select **PowerPoint**, and then share the PowerPoint file.



NOTE

If you choose to share the PowerPoint application rather than a specific PowerPoint file, you are unable to write or draw on the PowerPoint file.

3. Click **Content**, and then select **Take Over as Presenter** (on the console).

OR

Press the mode bar (up or down arrow), and then press **Yes** when prompted to take over as the presenter (on interactive flat panels).

4. Press the mode bar, press **Annotate**, and then write or draw using your finger or one of the interactive flat panel pens.
5. Press **Stop Presenting** on the guest laptop when done.

Connecting a room computer

If you want to connect a room computer to your room system, you need to enable the Room PC View feature. Users can then share the room computer's display by pressing the appropriate controls on the console.

If the room system has a SMART Room System USB Bridge and firmware version 15.11, you can also connect the SMART Room System USB Bridge to the room computer to enable interaction from an interactive flat panel.



NOTES

- The Room PC View feature is available only in versions 15.10 and later of Lync Room System software. You can download and install the latest version of Lync Room System software or configure your room system to download and install updates automatically in the Lync Admin Console (see *Updating software and firmware* on page 56).
- Ensure your organization's networking conferencing policies are compatible with Room PC View.

To enable the Room PC View feature

1. On the console, press **Options**, and then press **Settings**.

The *Enter your credentials* screen appears.

2. Type the room system administrator account's user name and password in the text boxes, and then press **Authenticate**.

The room system restarts.

3. Type the room system administrator account's password, and then press ENTER.

The Lync Admin Console appears.

4. Press **System Settings**.
5. Turn on **Room PC View**.
6. Press **Apply & Restart**.

To share the room computer's display when in a meeting

1. Ensure the room computer is connected to the room system and the room computer's video port is active.
2. Press **Content** on the console.

3. Press **Desktop/Device**, and then press **Start Presenting**.

The room computer's display appears on one of the interactive flat panels.



NOTES

- If the room computer is connected to a SMART Room System USB Bridge and is set up as described in *Installing software for the SMART Room System USB Bridge* on page 42, users can interact with the computer by touching the interactive flat panel.
- You might need to orient touch (see *Orienting touch* below).

4. Press **Desktop/Device**, and then press **Stop Presenting** when done.

To share the room computer's display when not in a meeting

1. Ensure the room computer is connected to the room system through the video connection harness's HDMI cable or VGA cable.
2. Press **Room PC View**  on the console.

The room computer's display appears on one of the interactive flat panels.



NOTES

- If the room computer is connected to a SMART Room System USB Bridge and is set up as described in *Installing software for the SMART Room System USB Bridge* on page 42, users can interact with the computer by touching the interactive flat panel.
- You might need to orient touch (see *Orienting touch* below).

3. Press **Room PC View**  when done.

Orienting touch

You need to orient touch on each computer you connect to your room system using the SMART Room System USB Bridge. The procedure for orienting touch differs depending on whether SMART Product Drivers is installed on the computer.

You might need to repeat the orientation procedure at a later time if touch isn't accurate. This can happen if you change the resolution on the computer or connect another computer to your room system.

To orient touch when SMART Product Drivers is installed

1. Ensure the computer is connected to the room system.
2. Press the **Orientation** button  on the interactive flat panel's color select module.

The orientation screen appears on the interactive flat panel's display.



NOTES

- If you connect a computer that's configured to duplicate the desktop on multiple displays, the orientation screen appears on both the interactive flat panel's display and the computer's display.
- If you connect a computer that's configured to extend the desktop across multiple displays and the orientation screen appears on the computer's display rather than the interactive flat panel's display, press the **Orientation** button  until the orientation screen appears on the interactive flat panel's display.

3. Follow the on-screen instructions to orient touch.

To orient touch when SMART Product Drivers isn't installed (Windows operating systems only)



NOTE

This procedure varies depending on your version of Windows operating system and your system preferences.

1. Ensure the computer is connected to the room system.
2. Open Control Panel.
3. Press **Hardware and Sound**, and then press **Tablet PC Settings**.

The *Tablet PC Settings* dialog box appears.

4. Select the appropriate display in the *Display* drop-down list, and then press **Calibrate**.

The *Calibrate pen or touch input screens* dialog box appears.

5. Press **Touch input**.

The orientation screen appears.

6. Follow the on-screen instructions to orient touch.

Using the whiteboard feature

Users can use the interactive flat panel's pens and eraser to write, draw and erase digital ink in a whiteboard file. Alternatively, they can use their fingers to write or draw digital ink and their fists or palms to erase it.

In addition to writing, drawing and erasing digital ink, users can move digital ink and other objects in the whiteboard file and create additional whiteboard files.

To open a whiteboard file when in a meeting

1. Press **New Whiteboard** on the console or on one of the interactive flat panels.
2. Write or draw digital ink.



NOTES

- Remote participants see the whiteboard session in real time and can add their own digital ink notes to it as part of a collaborative effort.
- Remote participants connecting to the meeting through some smart phones and other mobile devices are unable to view whiteboard sessions due to limitations of the Lync client software for those devices.

3. Press **Email Whiteboard** when you're done to e-mail the whiteboard file.

To open a whiteboard file when not in a meeting

1. Press **Start Whiteboard** on the console or on one of the interactive flat panels.
2. Write or draw digital ink.
3. Press **Email Whiteboard** when you're done to e-mail the whiteboard file.

Supporting users with special needs

Lync Room System software includes the following features to support users with special needs:

- High contrast themes
- Screen narrator
- Screen magnifier

 **NOTE**

These features are available only in newer versions of Lync Room System software. You can download and install the latest version of Lync Room System software or configure your room system to download and install updates automatically in the Lync Admin Console (see *Updating software and firmware* on page 56).

 **To apply a high contrast theme**

1. Press **Options** on the console.
2. Press **Dark Theme** to apply a high contrast theme with light text and graphics on a dark background.

OR

Press **Light Theme** to apply a high contrast theme with dark text and graphics on a light background.

Lync Room System software appears in the selected theme.

 **NOTE**

To return to the default them, press **Options** on the console, and then press **Default Theme**.

 **To use the screen narrator**

1. Ensure the speakers are properly connected and working.
2. Press **Options** on the console, and then press **Start Narrator**.

The *Microsoft Narrator* dialog box appears.

3. Set the controls in the *Microsoft Narrator* dialog box.

 **TIP**

For more information on the controls in the *Microsoft Narrator* dialog box, press **Quick Help**.

4. Use the screen narrator to read text on the screen.

 **To use the screen magnifier**

1. Press **Options** on the console, and then press **Start Magnifier**.

The *Magnifier* toolbar appears.

2. Set the controls in the *Magnifier* toolbar.



TIP

For more information on the controls in the *Magnifier* toolbar, press **Help** .

3. Use the screen magnifier to magnify text and graphics on the screen.

Ending meetings

At the end of the meeting, users can press **Leave Meeting** on the console to disconnect the room system from the Lync meeting. The Lync meeting ends when all participants have left.

Chapter 6

Maintaining your room system

Recommended tools	52
Remotely monitoring your room system	53
Installing the Lync Room System Administrative Web Portal	53
Using the Lync Room System Administrative Web Portal	53
Updating software and firmware	56
Turning off your room system	57
Maintaining the interactive flat panels	59
Calibrating the interactive flat panels	59
Orienting the interactive flat panels	62
Cleaning the screens	63
Cleaning the presence detection sensors	64
Cleaning the camera windows and reflective tape	64
Maintaining ventilation	65
Preventing condensation	65
Replacing a pen nib	66
Using the kickstands to access connectors	66
Maintaining the console	67
Maintaining the camera	67
Maintaining the microphones	68
Maintaining the speakers	68
Checking your room system cable connections	68
Checking your room system installation	68
Removing and transporting your room system	69

Your room system is designed to require no, or only minimal, cleaning and other maintenance.

If your room system requires cleaning or other maintenance or if your organization mandates periodic cleaning or other maintenance of its IT infrastructure, follow the instructions in this chapter.

Recommended tools

The following are recommended tools that professional, trained installers and IT specialists should have available for maintenance and troubleshooting purposes:

Activity	Recommended tools
Hardware service	<ul style="list-style-type: none">• Paper and pencil• Ladder• Tape measure• Set of screwdrivers, including flat blade, Phillips No. 1 and Phillips No. 2• Flashlight• Nylon cable ties• Cable tie cutter
Hardware isolation testing	<ul style="list-style-type: none">• 16' 5" (5 m) USB cable• 16' 5" (5 m) USB cable with mini-B connector• 16' 5" (5 m) active USB extension cable• 20' 8" (6.3 m) HDMI cable• Functional spare Lync appliance• Functional spare console and power supply• Functional spare camera kit• Functional spare microphone and audio processor kit, including cables• Functional spare speaker kit, including cables• Functional spare power supplies for the camera, audio processor and speakers for room systems with SMART Board 8055i interactive flat panels
IT access	<ul style="list-style-type: none">• IT administrator with knowledge of your organization's Lync infrastructure• SMART Board interactive flat panel remote control• USB keyboard and mouse• Laptop that has Outlook and Lync client software and that is connected to your organization's Lync infrastructure• Internet access for documentation and other resources (see <i>Other documentation and resources</i> on page 8)• Alternative audio source, such as a portable music player

Remotely monitoring your room system

Using the Lync Room System Administrative Web Portal, you can remotely collect diagnostic information to monitor the health of your SMART Room System.

NOTE

In addition to remotely monitoring your room system using the Lync Room System Administrative Web Portal, you can remotely manage it using Lync Infrastructure Environment Administrator tools such as System Center Operations Manager (SCOM). For more information, see microsoft.com/download/details.aspx?id=29256.

Installing the Lync Room System Administrative Web Portal

To install the Lync Room System Administrative Web Portal

1. Download the installation file from microsoft.com/en-us/download/details.aspx?id=40329.
2. Follow the instructions in technet.microsoft.com/en-us/library/dn436324.aspx to configure your environment for the Lync Room System Administrative Web Portal and then install the Lync Room System Administrative Web Portal.

Using the Lync Room System Administrative Web Portal

Once you have installed the Lync Room System Administrative Web Portal, you can use it to do the following:

- Set a room system's password, room tag and audio volumes
- View a room system's information and health status
- Save a room system's diagnostic log
- Restart a room system

To log on to the Lync Room System Administrative Web Portal

1. Open your Internet browser.
2. Go to the following address:

`https://[Computer]/lrs`

Where *[Computer]* is the address of the computer you installed the Lync Room System Administrative Web Portal on.

3. Type your user name and password in the appropriate boxes.

4. Click **Sign in**.

The *Lync Room System Admin Portal* page appears. The table on this page contains important information for all room systems on your organization's network.

To set a room system's password, room tag and audio volumes

1. Log on to the Lync Room System Administrative Web Portal (see *To log on to the Lync Room System Administrative Web Portal* on the previous page).
2. Click the room system's **Room Name** link.
3. Click **Settings**.
4. Set the following controls:

Control	Procedure
Credentials	
• Password	Type the room system's password, and then click Set .
• Show password	Select the check box to show the password.
Room Tag	
• Tag	Type the room system's tag, and then click Update .
Audio	
• Default Speaker Volume	Move the slider to the right to increase the default speaker volume or move the slider to the left to decrease the default speaker volume, and then click Set Default Volumes .
• Default Microphone Volume	Move the slider to the right to increase the default microphone volume or move the slider to the left to decrease the default microphone volume, and then click Set Default Volumes .
• Default Ringer Volume	Move the slider to the right to increase the default ringer volume or move the slider to the left to decrease the default ringer volume, and then click Set Default Volumes .

5. Click **Sign out** when done.

To view a room system's information and health status

1. Log on to the Lync Room System Administrative Web Portal (see *To log on to the Lync Room System Administrative Web Portal* on the previous page).
2. Click the room system's **Room Name** link.

3. Click **Details**.

A page showing the room system's information, including its name, hardware components and software versions, appears.

4. Click **Health**.

A page showing the room system's health status, including the status of its network connection and audio and video devices, appears.

5. Click **Sign out** when done.

To save a room system's diagnostic logs

1. Log on to the Lync Room System Administrative Web Portal (see *To log on to the Lync Room System Administrative Web Portal* on page 53).
2. Click the room system's **Room Name** link.
3. Click **Logging**.
4. Type the path where you want to save the diagnostics logs in the *Save to* box, and then click **Save Logs**.
5. Click **Sign out** when done.

To restart a room system

1. Log on to the Lync Room System Administrative Web Portal (see *To log on to the Lync Room System Administrative Web Portal* on page 53).
2. Click the room system's **Room Name** link.
3. Click **Logging**.
4. Press **Restart Console** to restart the console.

OR

Press **Restart PC** to restart the Lync appliance.

5. Click **Sign out** when done.

Updating software and firmware

At a scheduled time each night, your room system checks for updates to its software and firmware from Windows Update. It then installs any updates and restarts.

You can also manually check for updates.

To manually check for updates

1. On the console, press **Options**, and then press **Settings**.

The *Enter your credentials* screen appears.

2. Type the room system administrator account's user name and password in the text boxes, and then press **Authenticate**.

The room system restarts.

3. Type the room system administrator account's password, and then press ENTER.

The Lync Admin Console appears.

4. Press **Web Updates**.

5. Press **Check Updates and Install**.

Lync Room System software checks for and installs any updates.

6. Press **Apply & Restart**.

Turning off your room system

For some maintenance procedures, you need to turn off your room system.

To turn off your room system

1. On the console, press **Options**, and then press **Restart**.
2. When the screens are blank or when the SMART logo appears, complete the appropriate procedure for the room size:

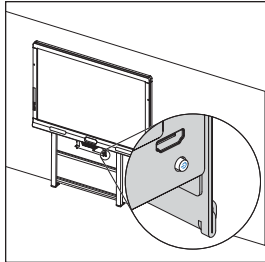
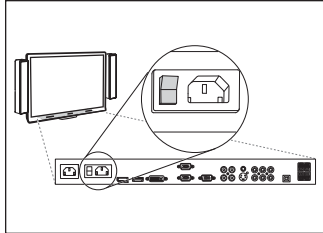
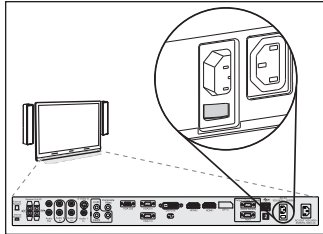
Room size	Procedure
Extra small room	<ol style="list-style-type: none">a. Press the power button on the Lync appliance enclosure for six seconds.  <ol style="list-style-type: none">b. Flick the power switch on the bottom of the interactive flat panel. 
Small room	<p>Flick the power switch on the bottom of the interactive flat panel.</p> 

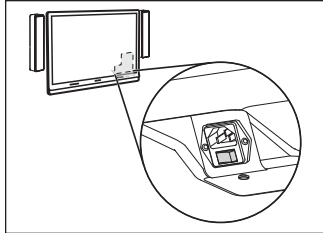
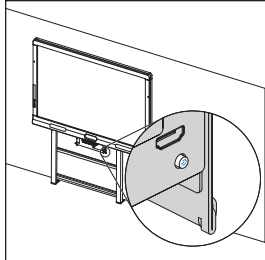
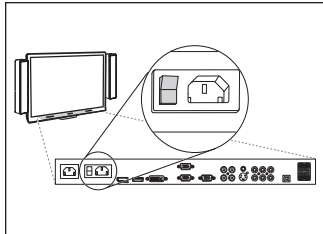
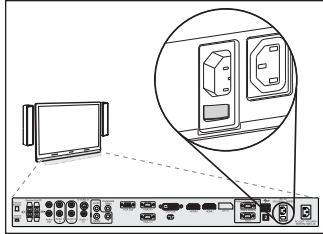
Room size	Procedure
Medium room	Flick the power switch on the bottom of the interactive flat panel. 
Medium room with dual panels	a. Press the power button on the Lync appliance enclosure for six seconds.  b. Flick the power switch on the bottom of both interactive flat panels. 
Large room	Flick the power switch on the bottom of both interactive flat panels. 

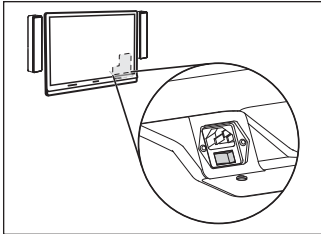
Room size	Procedure
Extra large room	Flick the power switch on the bottom of both interactive flat panels. 

Maintaining the interactive flat panels

Complete the following tasks on a regular basis to maintain your room system's interactive flat panels:

- Calibrate and orient the interactive flat panels as necessary
- Clean the screen
- Clean the presence detection sensors
- Clean the camera windows and reflective tape
- Maintain ventilation
- Prevent condensation
- Replace pen nibs as necessary

Calibrating the interactive flat panels

Digital cameras in the corners of the interactive flat panels track the position of the pens, eraser and your finger on the screens, and then send the information to SMART Product Drivers, which interprets this information as mouse clicks, digital ink or ink removal in the appropriate location. Calibration determines the position and angles of the cameras to accurately identify the location of touches on the interactive flat panels.

Typically, you need to calibrate the interactive flat panels during initial configuration only (see *Configuring SMART Settings* on page 30). However, you might need to calibrate the interactive flat panels after initial configuration in the following situations:

- Digital ink disappears as users write or draw.
- The environment lighting changes.



IMPORTANT

- To calibrate the interactive flat panels, you need the room system administrator account's user name and password.
- If an error message appears while you are calibrating the interactive flat panels, contact your SMART reseller or SMART Support (smarttech.com/contactsupport).

To calibrate an interactive flat panel

1. On the console, press **Options**, and then press **Settings**.

The *Enter your credentials* screen appears.

2. Type the room system administrator account's user name and password in the text boxes, and then press **Authenticate**.

The room system restarts.

3. Type the room system administrator account's password, and then press ENTER.

The Lync Admin Console appears.

4. Press **OEM Settings**, and then press **SMART Settings**.

SMART Settings appears.

5. Press **SMART Hardware Settings**.

6. Press the icon of the interactive flat panel you want to calibrate.

7. Select **Advanced Settings** from the drop-down list.

8. Press **Calibrate**.

The calibration screen appears. This can take a few moments.



 **NOTE**

If the calibration screen doesn't appear on the selected interactive flat panel, move it to the selected interactive flat panel by pressing the spacebar on the keyboard or the **Orient** button  on the interactive flat panel's color select module.

9. Press the red target with the tip of an interactive flat panel pen. Hold the tip at the center of the target until the target turns green, and then lift the pen.

The target moves to the next location.

 **IMPORTANT**

Hold the pen perpendicular to the screen.

 **NOTE**

You can calibrate a target again by pressing the **Keyboard** button or the **Right-click** button on the interactive flat panel's color select module.

10. Continue pressing targets until the calibration is complete.

A message appears stating that the calibration was successful, and then the orientation screen appears.

11. Orient the interactive flat panel (see *Orienting the interactive flat panels* on the next page).

12. On the console, press **OK**.

SMART Settings closes.

13. On the console, press **Apply & Restart**.

The room system restarts.

Orienting the interactive flat panels

Typically, you need to orient the interactive flat panels during initial configuration only (see *Configuring SMART Settings* on page 30). However, you might need to orient the interactive flat panels again if the location of users' touch is misinterpreted (a pointer appears a distance from the actual contact or on a different display than the one being touched).



IMPORTANT

To orient the interactive flat panels, you need the room system administrator account's user name and password. You're unable to orient the interactive flat panels in meeting mode.

To orient an interactive flat panel

1. On the console, press **Options**, and then press **Settings**.

The *Enter your credentials* screen appears.

2. Type the room system administrator account's user name and password in the text boxes, and then press **Authenticate**.

The room system restarts.

3. Type the room system administrator account's password, and then press ENTER.

The Lync Admin Console appears.

4. Press the **Orient** button  on the interactive flat panel's color select module.

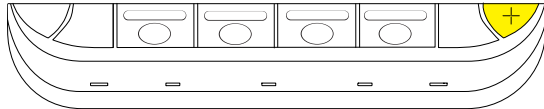

The orientation screen appears.

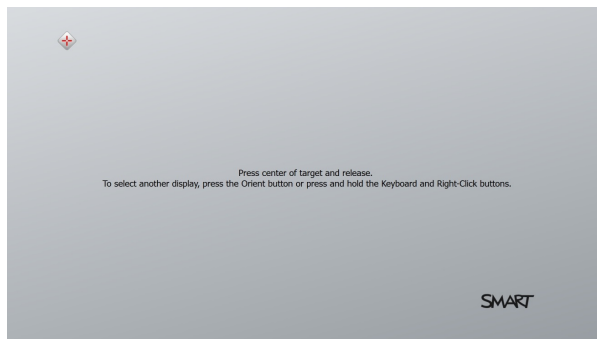

5. Use an interactive flat panel pen to press the red targets as they appear. Hold the tip of the pen at the center of each target, and then lift the pen.

The target moves to the next orientation point.



IMPORTANT

Hold the pen perpendicular to the screen.

6. Continue until you've pressed all the targets.

The orientation window closes.

7. On the console, press **Apply & Restart**.

The room system restarts.

8. If this doesn't correct inaccurate touch control, calibrate the interactive flat panel (see *Calibrating the interactive flat panels* on page 59).

Cleaning the screens

Follow these instructions to clean the interactive flat panels' screens without damaging their anti-glare coating or other product components.



CAUTION

- Do not use permanent or dry-erase markers on the screens. If dry-erase markers are used on the screens, remove the ink as soon as possible with a lint-free, non-abrasive cloth.
- Do not rub the screens with a dense or rough material.
- Do not apply pressure to the screens.
- Do not use cleaning solution or glass cleaner on the screens, because they can deteriorate or discolor the screens.
- Avoid touching the reflective tape between the screens and the bezel, and ensure that this strip stays dry. Damage to this strip affects touch interactivity.

To clean the screens

1. Turn off your room system (see *Turning off your room system* on page 57), and then disconnect the power sources for the interactive flat panels.
2. Wipe the screens with a lint-free, non-abrasive cloth.

Cleaning the presence detection sensors

Each interactive flat panel has two presence detection sensors on its frame. The sensors should be inspected regularly for dust and should be cleaned if any obvious dust buildup has occurred.

CAUTION

Do not use compressed air, water, chemical agents or cleaning agents to clean the sensors.

To clean the presence detection sensors

1. Turn off your room system (see *Turning off your room system* on page 57), and then disconnect the power sources for the interactive flat panels.
2. Gently wipe the sensors using a clean lint-free cloth.

Cleaning the camera windows and reflective tape

The DViT technology in the interactive flat panels uses four cameras in the corners of the frames and the reflective material between the screens and the bezels. Excessive dust buildup on the camera windows or reflective tape can impair touch performance.

These areas should be inspected regularly for dust and should be cleaned if any obvious dust buildup has occurred.

CAUTION

- Do not use compressed air to clean the camera windows or borders.
- Do not use water, chemicals or cleaning agents.
- Applying too much pressure when cleaning the tape or cameras can damage the tape and cameras and cause performance issues or errors.

To clean the camera windows and reflective tape

1. Turn off your room system (see *Turning off your room system* on page 57), and then disconnect the power sources for the interactive flat panels.
2. Using a clean lint-free cloth, gently wipe the camera windows in the top corners and the reflective tape along the top of the interactive flat panel screens.
3. Gently wipe the reflective tape along the sides of the interactive flat panel screens.
4. Gently wipe the camera windows in the bottom corners and the reflective strip across the bottom of the interactive flat panel screens.

Maintaining ventilation

The interactive flat panels require ventilation to enable the cooling fans to function. Dust buildup in the ventilation holes compromises cooling and leads to product failure.

- Clean accessible ventilation holes monthly with a dry cloth.
- Use a vacuum cleaner with a narrow hose-end attachment to clear the back ventilation holes regularly.

CAUTION

Avoid setting up or using your room system in an area with excessive levels of dust, humidity or smoke.

Preventing condensation

The interactive flat panel screens contain layers of glass that can collect condensation, especially in the following conditions:

- Temperature extremes with high humidity
- Rapid changes in humidity, which can occur when you operate the room system near water, such as a sink, pool, kettle or air conditioner ventilator
- Direct exposure to sunlight

To evaporate condensation from the interactive flat panels

1. Remove the humidity source from the room system, if possible.
2. Adjust the room temperature to normal operating ranges.
3. Turn on the room system for 2–3 hours.
4. If the screen condensation doesn't evaporate, contact your SMART reseller or SMART Support (smarttech.com/contactsupport).

Replacing a pen nib

To prevent damage to your interactive flat panels' anti-glare coating, replace a pen nib if it becomes worn. Replacement pen nibs are included with your room system, and you can purchase additional replacements from your authorized SMART reseller (smarttech.com/where) or the SMART Parts Store (parts.smarttech.com).

To replace a pen nib

1. Grasp the worn nib on the pen with a pair of pliers, and then pull and twist the nib loose.
2. Press the replacement nib into the pen.

Using the kickstands to access connectors

For some maintenance and troubleshooting procedures, you might need to access the interactive flat panels' connectors. You can use the kickstands to access these connectors.

To deploy the kickstands

1. Release the kickstand locks by pulling them down.

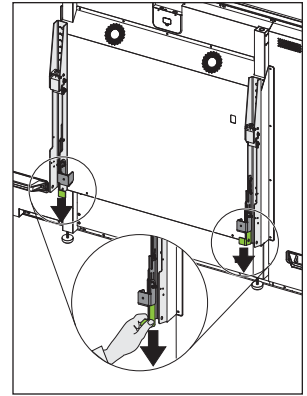

2. Pull the bottom of the interactive flat panel away from the wall.

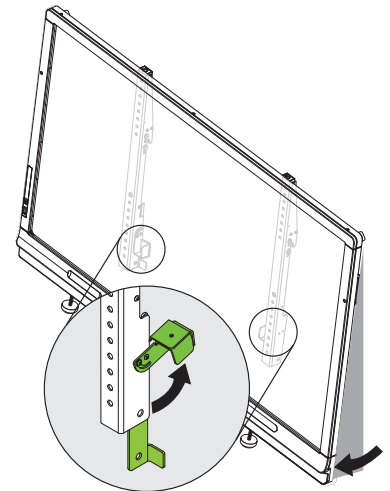

3. Deploy the kickstands by pushing them up and toward the wall.

 **NOTE**

When you've completed your maintenance or troubleshooting and no longer need access to the connectors, push the kickstands down, push the locks up and then place the interactive flat panel back in its original position.

Maintaining the console

Follow these instructions to clean the console's screen without damaging its anti-glare coating or other product components.

 **CAUTION**

- Do not rub the screen with a dense or rough material.
- Do not apply excessive pressure to the screen.
- Do not use cleaning solution or glass cleaner on the screen, because they can deteriorate or discolor the screen.

 **To clean the screen**

1. Turn off your room system (see *Turning off your room system* on page 57), and then disconnect the power source for the console.
2. Wipe the screen with a lint-free, non-abrasive cloth to remove finger prints and minor buildup.

OR

Apply a laptop screen cleaning solution to a lint-free, non-abrasive cloth, and then wipe the screen with the cloth to remove more significant buildup.

 **CAUTION**

Do not apply the laptop screen cleaning solution or other liquids directly to the screen.

Maintaining the camera

 **CAUTION**

Do not directly contact the camera lens, even to clean it. Directly contacting the camera lens can scratch or otherwise damage it, negatively impacting the camera's performance.

You need to clean the camera lens only if there is visible accumulation of dust. Use a canister of inert gas or a blower bulb to blow the dust off of the lens. Don't blow off dust with your mouth because this can deposit droplets of saliva on the camera lens.

Maintaining the microphones

Follow these instructions to clean the microphones.

To clean the microphones

1. Turn off your room system (see *Turning off your room system* on page 57).
2. Wipe the microphones with a lint-free, non-abrasive cloth.

Maintaining the speakers

Follow these instructions to clean the speakers.

To clean the speakers

1. Turn off your room system (see *Turning off your room system* on page 57).
2. Wipe the speakers with a lint-free, non-abrasive cloth.

Checking your room system cable connections

Inspect your room system's cables on a regular basis to ensure they are securely connected. Using cable strain relief ensures cables remain securely connected and prevents technical issues associated with disconnected cables.

Checking your room system installation

Inspect your room system's hardware installation frequently to ensure that it remains secure.

- Check the mounting location for signs of damage or weakness that can occur over time.
- Check for loose screws, gaps, distortions or other issues that could occur with the mounting apparatus.

If you find an issue, refer to a professional installer.

Inspect your room system's software installation by making a test call (see *Testing your room system* on page 82).

Removing and transporting your room system

 **WARNING**

Only professional, trained installers should remove your room system.

 **CAUTION**

- Save your original packaging so that you can repack your room system with as much of the original packaging as possible. This packaging was designed with optimal shock and vibration protection. If your original packaging isn't available, you can purchase the same packaging directly from your authorized SMART reseller (smartechnology.com/where).
- Transporting your room system without correct packaging voids your warranty and could lead to product damage.

Chapter 7

Troubleshooting your room system

Resolving hardware issues	71
Locating serial numbers	72
Locating power and status lights	73
Resolving issues with the interactive flat panels	74
Resolving issues with the console	76
Resolving issues with the camera	77
Resolving issues with the microphones	78
Resolving issues with the speakers	78
Resolving issues with connected computers	79
Resolving software issues	80
Resolving issues with the calendar	80
Resolving issues with shared PowerPoint files	81
Improving the restart time	81
Adding trusted domains to your room system	81
Testing your room system	82

This chapter provides you with the information necessary to solve simple issues that can occur with your room system's hardware and software.

For the *SMART Room System for Microsoft Lync troubleshooting decision tree* and other troubleshooting resources, refer to the SMART knowledge base (see *Knowledge base* on page 10).

Resolving hardware issues

This section explains how to resolve common issues with your room system's hardware. If issues persist or aren't covered, contact your SMART reseller or SMART Support (smarttech.com/contactsupport).

Locating serial numbers

Each of the major components of your room system has a serial number.

Component	Serial number location						
Interactive flat panel	Bottom of the interactive flat panel on the left side						
	 NOTES <ul style="list-style-type: none">• When requesting technical support, provide SMART Support with the left interactive flat panel's serial number.• You can also access the interactive flat panel's serial number from the on-screen display menu. <table><tbody><tr><td>SBID 8055i</td><td><i>SERIAL NUMBER</i> on page 99</td></tr><tr><td>SBID 8070i-G4</td><td><i>SERIAL NUMBER</i> on page 105</td></tr><tr><td>SBID 8084i-G4</td><td><i>Serial Number</i> on page 115</td></tr></tbody></table>	SBID 8055i	<i>SERIAL NUMBER</i> on page 99	SBID 8070i-G4	<i>SERIAL NUMBER</i> on page 105	SBID 8084i-G4	<i>Serial Number</i> on page 115
SBID 8055i	<i>SERIAL NUMBER</i> on page 99						
SBID 8070i-G4	<i>SERIAL NUMBER</i> on page 105						
SBID 8084i-G4	<i>Serial Number</i> on page 115						
Lync appliance	Wide side of the Lync appliance						
Console	Bottom of the console						
Camera	Top of the camera beside the service light						
Table microphones	Bottom of each microphone						
Audio processor	Narrow side of the audio processor						
Speakers	Back of each speaker						

It's good practice to record these serial numbers in a safe place. You can use the *SMART Room System for Microsoft Lync software configuration guide* provided with your room system for this purpose.

Locating power and status lights

Your room system's components have power and status lights, which you can use when resolving common issues with the room system.

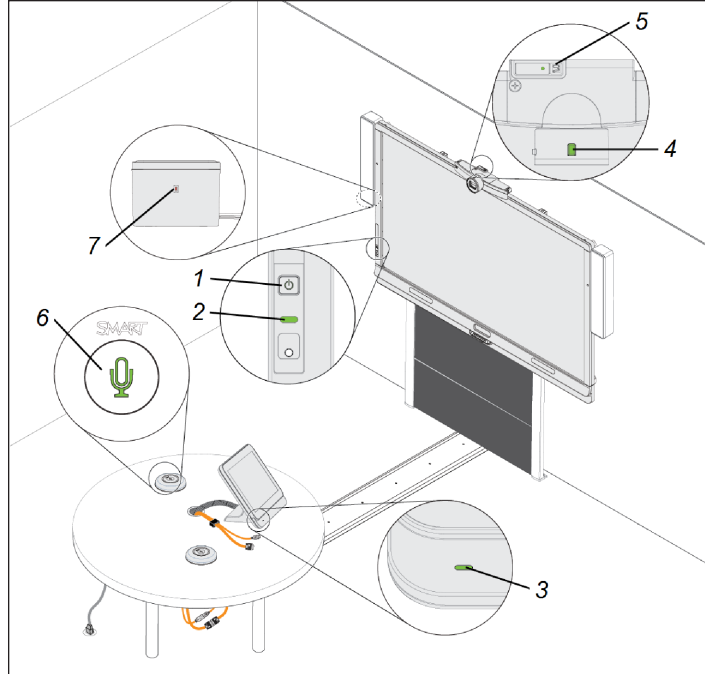

No.	Component	Light
1	Interactive flat panel	Power
2	Interactive flat panel	Touch system status
3	Console	Power and status
4	Camera	Video capture
5	Camera	Service
6	Microphones	Microphone
7	Speakers	Power

NOTE

The following power and status lights aren't shown in the above diagram:

- Power, hard drive activity and network connection lights on the Lync appliance
- Power light on the Lync appliance enclosure (room systems with SMART Board 8055i interactive flat panels only)

Resolving issues with the interactive flat panels

Use the following table to resolve issues with your room system's interactive flat panels.

Lights	Interactive flat panel status	Issues	Solutions
Power: Off Touch system: Off	Not receiving power	The interactive flat panels should be receiving power but aren't.	Ensure that the interactive flat panels are connected to the mains power supply and that the power switches are turned on.
Power: Solid red Touch system: Off	Off	The interactive flat panels are off.	Press the Power/Standby buttons  on the front control panels of the interactive flat panels to turn them on.
Power: Solid amber Touch system: Off	Standby mode	The interactive flat panel doesn't turn on when you enter the room.	<ul style="list-style-type: none"> • Enable presence detection (see page 92). • Reduce the room temperature to increase the difference between the ambient temperature and human body temperature. • Move closer to the interactive flat panels or make bigger motions. • Remove any glass, acrylic or other material between you and the presence detection sensors.
		The interactive flat panels are turning on after they've been turned off.	<ul style="list-style-type: none"> • Increase the re-enable time, which is the time between when you exit the room and when the presence detection sensors start detecting motion again. • Close any blinds or shades to prevent sunlight from hitting the presence detection sensors.
		The interactive flat panels are turning on when people aren't present.	<ul style="list-style-type: none"> • Remove sources of major temperature fluctuation (humidifier emission, air conditioning, heating system). • Close any blinds or shades to prevent sunlight from hitting the presence detection sensors.
Power: Solid green Touch system: Flashing amber (quickly)	Turning on	The status light continues flashing amber (quickly) for more than one minute.	Turn off the interactive flat panel (see page 57), wait a few minutes and then turn the interactive flat panel back on. ¹

¹For SMART Board 8055i interactive flat panels, also turn on the Lync appliance by pressing the power button on the Lync appliance enclosure (located behind the left interactive flat panel).

CHAPTER 7
TROUBLESHOOTING YOUR ROOM SYSTEM

Lights	Interactive flat panel status	Issues	Solutions
Power: Solid green Touch system: Flashing amber (slowly)	Updating firmware	The status light continues flashing amber (slowly) for more than five minutes.	Turn off the interactive flat panel (see page 57), wait a few minutes and then turn the interactive flat panel back on. ²
Power: Solid green Touch system: Flashing or solid green	On with no touch control	There's no touch control.	<ul style="list-style-type: none"> Use SMART Board Diagnostics, which is available from SMART Settings (see page 85), to troubleshoot the issue. Ensure that the USB cable is connected as shown in the installation instructions (see page 9).
Power: Solid green Touch system: Solid green	On with touch control	The display is blank.	<ul style="list-style-type: none"> For SMART Board 8055i interactive flat panels, press INPUT on the remote control until you select HDMI1. For SMART Board 8070i-G4 and 8084i-G4 interactive flat panels, press INPUT on the remote control until you select HDMI3/PC. Ensure that the HDMI cable is connected as shown in the installation instructions (see page 9).
		The image is unstable or unfocused.	Secure the HDMI cable at both connection points.
		The image is too light, too dark or has poor quality issues.	Press AUTO SETUP or AUTO on the interactive flat panel's remote control to automatically configure the video settings.
		There is a persistent image on the screen.	Turn off the interactive flat panel and leave it turned off for as long as the image was on the screen.
		When you touch the interactive flat panel, the touch point is in the wrong location.	<ul style="list-style-type: none"> You aren't touching the screen at right angles (see smarttech.com/kb/131299). Orient the interactive flat panel (see page 62).

²For SMART Board 8055i interactive flat panels, also turn on the Lync appliance by pressing the power button on the Lync appliance enclosure (located behind the left interactive flat panel).

Lights	Interactive flat panel status	Issues	Solutions
		An area of the screen doesn't respond to your touch. OR When you draw digital ink, the lines are broken.	<ul style="list-style-type: none"> • Ensure nothing is taped to the screen. • Remove obstructions from the reflective tape channel. • Use consistent pressure while drawing digital ink. • Close blinds or shades or dim light sources. • Calibrate your interactive flat panel (see page 59).
		You try to erase with the eraser, but you draw more digital ink. You don't see a flashing light on the color select module.	Increase the initial contact area of your eraser.
		You're trying to draw digital ink, but you're erasing digital ink.	<ul style="list-style-type: none"> • Lift other fingers and the palm of your hand from the interactive flat panel while you write because the interactive flat panel is interpreting them as an eraser. • Use a smaller pointer, such as the pen.
		Your room system isn't turning off when people have left the room.	<ul style="list-style-type: none"> • Enable presence detection (see page 92).
		Your room system is turning off when people are present.	<ul style="list-style-type: none"> • Increase the time before the interactive flat panel automatically turns off.

Resolving issues with the console

Use the following table to resolve issues with your room system's console.

Power light	Console status	Issues	Solutions
Off	Not receiving power	The console should be receiving power but isn't.	Ensure that the console is connected to the power supply as show in the installation instructions (see page 9).
Solid amber	Receiving power but not connected to the Lync appliance	There's an issue with the Lync appliance or the interactive flat panels.	Refer to the troubleshooting table on page 74.

Power light	Console status	Issues	Solutions
Solid green	Receiving power and connected to the Lync appliance	The screen is blank.	Ensure that the HDMI cable is connected as shown in the installation instructions (see page 9).
		The console screen appears on the interactive flat panel rather than on the console.	<ul style="list-style-type: none"> Follow the instructions on page 28 to correctly configure the room system software. Ensure that the cable from the HDMI1 receptacle on the Lync appliance is connected to the console.
		There's no touch control.	<ul style="list-style-type: none"> Use SMART Board Diagnostics, which is available from SMART Settings (see page 85), to troubleshoot the issue. Ensure that the USB cable is connected as shown in the installation instructions (see page 9).

Resolving issues with the camera

Use the following table to resolve issues with your room system's camera.

Lights	Camera status	Issues	Solutions
Video capture: Off Service: Off	Not receiving power	The camera should be receiving power but isn't.	Ensure that the camera is connected as shown in the installation instructions (see page 9) and that the room system is turned on.
Video capture: Off Service light: Flashing amber	Updating firmware	The service light continues flashing amber for more than five minutes.	Temporarily disconnect the power cable from the camera and then connect it again after a few seconds.
Video capture: Off Service light: Flashing red	Hardware error	The camera's video output doesn't appear.	Temporarily disconnect the power cable from the camera and then connect it again after a few seconds.
Video capture: Off Service light: Solid red	Hardware error (the USB cable isn't properly connected)	The camera's video output doesn't appear.	Ensure the USB cable from the camera is connected to the Lync appliance.
Video capture: Red Service light: Green	On but not capturing video	The camera's video output doesn't appear even though it should.	Perform a room system test (see page 82).

Lights	Camera status	Issues	Solutions
Video capture: Green Service light: Green	On and capturing video	The camera's video output doesn't appear.	Open the privacy shutter. (The privacy shutter is marked with a red spot to indicate when it's closed.)
		The video quality is poor.	Perform a room system test (see page 82).

Resolving issues with the microphones

Use the following table to resolve issues with your room system's microphones.

Microphone light	Microphone status	Issues	Solutions
Off	Not receiving power	The microphones should be receiving power but aren't.	Ensure that the microphones are connected as shown in the installation instructions (see page 9) and that the room system is turned on.
Red	On but muted	Remote participants are unable to hear room participants.	Unmute the microphones in Lync Room System software (or press the microphone button on the table microphones).
Green	On and not muted	Remote participants are still unable to hear room participants.	Perform a room system test (see page 82).

Resolving issues with the speakers

Use the following table to resolve issues with your room system's speakers.

Power light	Speaker status	Issues	Solutions
Off	Not receiving power	The speakers should be receiving power but aren't.	Ensure that the speakers are connected as shown in the installation instructions (see page 9) and that the room system is turned on.

Power light	Speaker status	Issues	Solutions
On	On	You're unable to hear sound.	<ul style="list-style-type: none"> • Unmute the audio in Lync Room System software. • Turn up the volume in Lync Room System software. • For SMART Board 8070i-G4 interactive flat panels, ensure the audio input is <i>IN2</i> (see page 104). For SMART Board 8084i-G4 interactive flat panels, ensure the AUDIO2 input is <i>HDMI3/PC</i> (see page 111).³ • Ensure the audio processor is receiving power and is connected as shown in the installation instructions (see page 9).
		You can hear sound, but it's quiet.	Using the console, turn up the volume in Lync Room System software settings.
		You can hear sound, but it's distorted, or there's feedback.	One or more of the remote participants' audio systems is causing the distortion or feedback. Mute individual remote participants until you identify the remote participants with problematic audio systems. Ask those remote participants to troubleshoot their audio systems.

Resolving issues with connected computers

If video input from a connected guest laptop or room computer isn't appearing on the interactive flat panels, do the following:

- Ensure the HDMI cable or the VGA cable from the video connection harness is properly connected to the computer.
- Ensure the video connection harness is properly connected to the room system.

³For room systems with SMART Board 8055i interactive flat panels, the speakers aren't connect to the interactive flat panels.

- For guest laptops:
 - Ensure the laptop's external display connector is enabled.

 **NOTE**

Depending on the laptop, the external display connector might be enabled automatically or you might need to press a key on the keyboard. See the laptop's documentation for instructions.

- If the console prompts you to share your screen with everyone in the meeting, press **Yes**.
- For room computers:
 - Ensure the Room PC View feature is enabled (see *Connecting a room computer* on page 44).
 - On the console, press **Content, Start Presenting** and then **Start Presenting** (if you're in a meeting) or **Room PC View** (if you're not in a meeting).

If touch isn't working for a connected guest laptop or room computer, do the following:

- Ensure the SMART Room System USB Bridge is properly connected to the room system and the computer.
- Ensure the necessary software is installed on the computer (see *Installing software for the SMART Room System USB Bridge* on page 42).
- Orient touch (see *Orienting touch* on page 46).

Resolving software issues

This section explains how to resolve common issues with your room system's software.

Before troubleshooting issues with your room system's software, ensure the latest versions of the software are installed (see *Updating software and firmware* on page 56).

If issues persist or aren't covered, contact Microsoft for support.

Resolving issues with the calendar

If the Lync Room System software calendar doesn't appear on the console and interactive flat panels, or if it indicates that the room is free for 24 hours when you know that it has been booked for meetings, there is an issue with the connection between the room system and your organization's Microsoft Exchange server. For assistance with these and other network issues, contact your organization's network administrator.

Resolving issues with shared PowerPoint files

Users can share PowerPoint files using the room system (see *Connecting a guest laptop using Lync client software* on page 44). If participants are unable to write or draw digital ink over a PowerPoint file, ensure the user is sharing the PowerPoint file (and not the screen, part of the screen or the PowerPoint application) and that permissions are set so that either the presenter or everyone can write or draw digital ink over the file.

Improving the restart time

If you find the room system takes a long time to restart when you are modifying settings, you can remove unused Microsoft language packs to improve the restart time. For more information, see *Improving the start-up and restart time on a SMART Room System for Microsoft Lync* (knowledgebase.force.com/?q=000014391).

Adding trusted domains to your room system

If the domain name used in the Lync account's SIP URI is different from the domain name on the Lync Web Service certificate, your room system might not connect to the Lync Server. When this occurs, a dialog box might appear asking if you want to trust the certificate, but this dialog box disappears quickly thereafter.

In this situation, you need to add the domain name specified in the *Subject Name* and *Common Name* fields of the Lync Web Service certificate to the room system.



CAUTION

Use caution when you open the Windows registry editor. If you incorrectly modify the Windows registry, you can damage the Lync appliance's operating system.

To add a trusted domain to your room system

1. On the console, press **Options**, and then press **Settings**.
The *Enter your credentials* screen appears.
2. Type the room system administrator account's user name and password in the text boxes, and then press **Authenticate**.
The room system restarts.
3. Type the room system administrator account's password, and then press ENTER.
The Lync Admin Console appears.
4. Connect a mouse and keyboard to the Lync appliance.

5. Press **System Settings**, and then press **Network Connections**.
Control Panel appears.
6. Type **regedit** in the address bar.
The *Registry Editor* window appears.
7. In the left pane, browse to and open **HKEY_LOCAL_MACHINE\SOFTWARE\Policies\Microsoft\Office\15.0\Lync**.
8. In the right pane, right-click and select **New > String Value**.
A new string appears.
9. Type **TrustModelData**, and then press ENTER.
10. Right-click the string you created in steps 8 and 9, and then select **Modify**.
The *Edit String* dialog box appears.
11. Type the domain name specified in the *Subject Name* and *Common Name* fields of the Lync Web Service certificate in the *Value data* box, and then press **OK**.
12. Close the *Registry Editor* window.
13. Disconnect the mouse and keyboard.
14. Click **Apply & Restart**.
The room system restarts.

Testing your room system

If your particular issue wasn't covered in the previous sections or if the solutions in the previous sections didn't resolve your issue, you can test your room system.

NOTE

To complete a room system test, you need the room system administrator account's user name and password.

To complete a room system test

1. On the console, press **Options**, and then press **Settings**.
The *Enter your credentials* screen appears.

2. Type the room system administrator account's user name and password in the text boxes, and then press **Authenticate**.

The room system restarts.

3. Type the room system administrator account's password, and then press ENTER.

The Lync Admin Console appears.

4. Press **Lync Settings**.

5. Press **Make a Test Call**, and then follow the on-screen instructions to test call functions.



NOTE

You can make a test call only if your organization uses an on-premise Lync Server.

OR

Press **Test Meet Now**, and then follow the on-screen instructions to test server connections and video functions.

6. If you're unable to complete a test call or test meeting, wait one or two minutes and then try step 5 again.
7. Press **Apply & Restart**.

The room system restarts.

Appendix A

Using the Lync Admin Console and SMART Settings

Accessing the Lync Admin Console and SMART Settings	85
Lync Admin Console controls	86
SMART Settings controls	91

You can access the Lync Admin Console and SMART Settings using the console.

NOTE

To access the Lync Admin Console and SMART Settings, you need the room system administrator account's user name and password.

Accessing the Lync Admin Console and SMART Settings

To access the Lync Admin Console and SMART Settings

1. On the console, press **Options**, and then press **Settings**.

The *Enter your credentials* screen appears.

2. Type the room system administrator account's user name and password in the text boxes, and then press **Authenticate**.

The room system restarts.

3. Type the room system administrator account's password, and then press ENTER.

The Lync Admin Console appears.

4. Make changes (see *Lync Admin Console controls* on the next page).

5. If you want to make changes to SMART Settings, press **OEM Settings**, press **SMART Settings**, make changes (see *SMART Settings controls* on page 91), and then press **OK**.

6. If you want to apply your changes, press **Apply & Restart**.

OR

If you don't want to apply your changes, press **Undo & Restart**.

The Lync appliance restarts in meeting mode.

Lync Admin Console controls

Control	Procedure	Notes (if any)
Lync Settings		
▶ Credentials		
<ul style="list-style-type: none"> User Name 	Type the Lync account's full domain name in one of two formats depending on how your organization's servers are configured (for example, yourdomain\room1 or room1@yourdomain.com).	You can record this information in the <i>SMART Room System for Microsoft Lync software configuration guide</i> .
<ul style="list-style-type: none"> SIP URI 	Type the Lync account's SIP URI (for example, room1@yourdomain.com).	You can record this information in the <i>SMART Room System for Microsoft Lync software configuration guide</i> . If the domain name used in the Lync account's SIP URI is different from the domain name on the Lync Web Service certificate, see <i>Adding trusted domains to your room system</i> on page 81.
<ul style="list-style-type: none"> Password 	Type the Lync account's password.	You can record this information in the <i>SMART Room System for Microsoft Lync software configuration guide</i> .
▶ Proxy Credentials		
<ul style="list-style-type: none"> None 	Select to not specify credentials for proxy authentication.	SMART recommends that you use the Lync account credentials for proxy authentication.
<ul style="list-style-type: none"> User Lync Account credentials 	Select to use the Lync account credentials you provided in the <i>Credentials</i> section for proxy authentication.	
<ul style="list-style-type: none"> Other credentials 	Select to use other credentials for proxy authentication. Type the user name in the <i>User name</i> box and the password in the <i>Password</i> box.	
▶ Configuration Modes		
<ul style="list-style-type: none"> Automatic 	Select if your organization's autodiscover DNS records are set to automatically link to the Lync 2013 server pool.	

APPENDIX A
USING THE LYNC ADMIN CONSOLE AND SMART SETTINGS

Control	Procedure	Notes (if any)
<ul style="list-style-type: none"> Manual 	<p>Select if your organization's autodiscover DNS records aren't set to automatically link to the Lync 2013 server pool, such as when your organization maintains a mixed environment of Lync 2010 and Lync 2013 server pools.</p> <p>Type the address of the Lync 2013 server pool in the <i>Internal Server Name</i> box.</p>	
▶ Audio		
<ul style="list-style-type: none"> Default Speaker Volume 	<p>Move the slider to the right to increase the default speaker volume.</p> <p>OR</p> <p>Move the slider to the left to decrease the default speaker volume.</p>	
<ul style="list-style-type: none"> Default Microphone Volume 	<p>Move the slider to the right to increase the default microphone volume.</p> <p>OR</p> <p>Move the slider to the left to decrease the default microphone volume.</p>	
<ul style="list-style-type: none"> Default Ringer Volume 	<p>Move the slider to the right to increase the default ringer volume.</p> <p>OR</p> <p>Move the slider to the left to decrease the default ringer volume.</p>	
<ul style="list-style-type: none"> Make a Test Call 	<p>Press to test the room system's call functions.</p>	<p>See <i>Testing your room system</i> on page 82.</p>
<ul style="list-style-type: none"> Test Meet Now 	<p>Press to test the room system's server connections and video functions.</p>	<p>See <i>Testing your room system</i> on page 82.</p>
▶ Quality Control		
<ul style="list-style-type: none"> Sign up for the Customer Experience Program 	<p>Turn On to allow Microsoft to collect information about configuration, commonly used features and issues to improve future releases of Lync Room System software.</p> <p>OR</p> <p>Turn Off to not allow Microsoft to collect this information.</p>	<p>SMART recommends that you allow Microsoft to collect information.</p>
▶ Logging		
<ul style="list-style-type: none"> Help our support team help you 	<p>Select Off to disable logging.</p> <p>OR</p> <p>Select Light to enable recording of summary information and gathering information about specific errors.</p> <p>OR</p> <p>Select Full to enable recording of detailed information.</p>	<p>SMART recommends that you enable full logging.</p> <p>Review the Privacy supplement for Microsoft Lync before changing this setting.</p>

APPENDIX A
USING THE LYNC ADMIN CONSOLE AND SMART SETTINGS

Control	Procedure	Notes (if any)
<ul style="list-style-type: none"> Also turn on Windows Event Logging... 	Turn On to enable Windows Event Logging. OR Turn Off to disable Windows Event Logging.	SMART recommends that you enable Windows Event Logging. Review the Privacy supplement for Microsoft Lync before changing this setting.
System Settings		
▶ Monitor Layout		
<ul style="list-style-type: none"> Display content on the left screen 	Turn On to display content users share with others on the left interactive flat panel. OR Turn Off to not display content users share with others on the left interactive flat panel.	This control is available only for large room systems.
<ul style="list-style-type: none"> Tutorial Slide Show 	Turn On to enable the tutorial. Users can view the tutorial on the interactive flat panels to learn how to use the room system. OR Turn Off to disable the tutorial.	
<ul style="list-style-type: none"> Room PC View 	Turn On to enable the Room PC View feature. Users can show or hide a connected room computer's screen from the console. OR Turn Off to disable the Room PC View feature.	The Room PC View feature is available only in versions 15.10 and later of Lync Room System software. You can download and install the latest version of Lync Room System software or configure your room system to download and install updates automatically in the Lync Admin Console (see <i>Updating software and firmware</i> on page 56). Ensure your organization's networking conferencing policies are compatible with Room PC View.
▶ Control Panel		
<ul style="list-style-type: none"> System Properties 	Press to open the <i>System Properties</i> dialog box.	In the <i>System Properties</i> dialog box, you can view and manage the Lync appliance's system properties, including the computer name and network ID.
<ul style="list-style-type: none"> User Settings 	Press to open the <i>User Accounts</i> dialog box.	In the <i>User Accounts</i> dialog box, you can view and manage the user and administrator accounts you created during the initial configuration of your room system's software.
<ul style="list-style-type: none"> Certificate Manager 	Press to open the <i>Certificates</i> window.	In the <i>Certificates</i> window, you can view and manage certificates, which the Lync appliance uses to verify the identity of a person or device, authenticate a service, or encrypt files.
<ul style="list-style-type: none"> Event Viewer 	Press to open the <i>Event Viewer</i> window.	In the <i>Event Viewer</i> window, you can view and manage the Lync appliance's event logs.

APPENDIX A
USING THE LYNC ADMIN CONSOLE AND SMART SETTINGS

Control	Procedure	Notes (if any)
<ul style="list-style-type: none"> Internet Settings 	Press to open the <i>Internet Properties</i> dialog box.	In the <i>Internet Properties</i> dialog box, you can set Internet-related options, including Internet security zones and privacy preferences.
<ul style="list-style-type: none"> Network Connections 	Press to open the <i>Network Connections</i> window.	In the <i>Network Connections</i> window, you can view the status of the Lync appliance's network connection and set network options, including the DNS server address (see <i>Configuring Lync Room System software</i> on page 33).
<ul style="list-style-type: none"> Windows Firewall 	Press to open the <i>Windows Firewall</i> window.	In the <i>Windows Firewall</i> window, you can view the status of and configure Windows Firewall on the Lync appliance.
<ul style="list-style-type: none"> Date and Time 	Press to open the <i>Date and Time</i> dialog box.	In the <i>Date and Time</i> dialog box, you can set the date, time and time zone.
<ul style="list-style-type: none"> Region and Languages 	Press to open the <i>Region and Language</i> dialog box.	In the <i>Region and Language</i> dialog box, you can set region and language options, including date and time formats, keyboard layouts and display languages.
Web Updates		
<ul style="list-style-type: none"> Lync Room System Version 	Indicates the current version of Lync Room System software installed on the room system.	
▶ Microsoft Updates		
<ul style="list-style-type: none"> Download from Microsoft Update server 	Select to download Microsoft updates from the Microsoft Update server.	
<ul style="list-style-type: none"> Download from WSUS server 	Select to download Microsoft updates from your organization's Windows Server Update Services (WSUS) server. Type the URL of the WSUS server in the text box.	
▶ OEM Updates		
<ul style="list-style-type: none"> Download from OEM server 	Select to download SMART updates from the SMART server.	SMART recommends that you download updates from its server.
<ul style="list-style-type: none"> Download from internal server 	Select to download SMART updates from an internal server. Type the URL of the internal server in the text box.	
▶ Update Frequency		
<ul style="list-style-type: none"> Automatic updates 	Select to download and install updates automatically as they become available. OR Clear to download and install updates manually.	

APPENDIX A
USING THE LYNC ADMIN CONSOLE AND SMART SETTINGS

Control	Procedure	Notes (if any)
<ul style="list-style-type: none"> • Check Updates and Install 	Press to manually check for and install any updates.	See <i>Updating software and firmware</i> on page 56.
<ul style="list-style-type: none"> • Daily Maintenance Time 	Select the time of day you want to run maintenance checks.	Select a time outside of regular business hours.
▶ Factory Reset		
<ul style="list-style-type: none"> • Reset the Device to Factory Image 	Press to reset the room system to factory defaults.	See <i>Resetting the room system to factory defaults</i> on page 129.
Password Renewal		
<ul style="list-style-type: none"> • Auto-Renew Password 	Turn On to enable automatic renewing of the Lync account password, and then type the number of days between renewals in the <i>Renewal Frequency in Days</i> box. OR Turn Off to disable automatic renewing of the Lync account password.	SMART recommends that you disable automatic renewing of the Lync account password.
▶ Account Type		
<ul style="list-style-type: none"> • On-Premise 	Select if your organization uses an on-premise Lync Server.	
<ul style="list-style-type: none"> • Office 365 	Select if your organization uses an Office 365™-hosted Lync Server, and then type the connection point in the <i>Office 365 Connection Point</i> box.	
OEM Settings		
<ul style="list-style-type: none"> • SMART Settings 	Press to open SMART Settings.	See <i>SMART Settings controls</i> on the next page.
<ul style="list-style-type: none"> • SRS Licensing Tool 	Press to check the status of your room system's product key and provide a MAK key if your Lync infrastructure doesn't include a KMS server.	This control is available only for version 15.05 or earlier of Lync Room System software. See <i>Checking the status of the Lync Room System software product key</i> on page 34.
Lync License		
<ul style="list-style-type: none"> • Key Management Service (KMS) 	Press if your Lync infrastructure includes a KMS server.	This control is available only for version 15.06 or later of Lync Room System software. See <i>Checking the status of the Lync Room System software product key</i> on page 34.
<ul style="list-style-type: none"> • Multiple Activation Key (MAK) 	Press if your Lync infrastructure doesn't include a KMS server, and then provide a MAK key.	This control is available only for version 15.06 or later of Lync Room System software. See <i>Checking the status of the Lync Room System software product key</i> on page 34.

SMART Settings controls

Control	Procedure	Notes (if any)
SMART Room System Settings		
▶ Business Hours		
• 12-Hour Setting	Select if your organization's business day is 12 hours, and then select the appropriate time frame in the drop-down list.	Your room system enters power saving mode outside of the business hours you define on this page.
• Custom Setting	Select if your organization's business day isn't 12 hours, and then select the start and end times for your organization's business day.	
• Business Days	Select the days of the week your organization operates.	
SMART Hardware Settings		
▶ SMART Board		In room systems with two interactive flat panels, there are two <i>SMART Board</i> pages under <i>SMART Hardware Settings</i> (one for each interactive flat panel).
• Orient	Press to orient the interactive flat panel.	See <i>Orienting the interactive flat panels</i> on page 62.
▶ Orientation/Alignment Settings		
• Quick (4 Points)	Select to use four alignment points.	The Quick orientation is suitable for most purposes. You can perform a Quick orientation to re-orient the interactive flat panel with minimal interruption.
• Standard (9 Points)	Select to use nine alignment points.	The Standard orientation provides a slightly higher level of accuracy.
• Wide (12 Points)	Select to use 12 alignment points.	The Wide orientation is suitable for wide-screen interactive flat panels.
• Fine (20 Points)	Select to use 20 alignment points.	
• Defaults	Press to return orientation settings to their defaults.	
▶ Advanced Settings		
• Calibrate	Select to calibrate the interactive flat panel.	See <i>Calibrating the interactive flat panels</i> on page 59.

APPENDIX A
USING THE LYNC ADMIN CONSOLE AND SMART SETTINGS

Control	Procedure	Notes (if any)
▶ Proximity Settings		
• Turn on the proximity feature	Select to enable presence detection.	If you change these options in SMART Settings, the changes appear in the interactive flat panel's on-screen display menu (see page 100 for SMART Board 8055i interactive flat panels, page 105 for SMART Board 8070i-G4 interactive flat panels or page 113 for SMART Board 8084i-G4 interactive flat panels). However, if you change these options in the on-screen display menu, the changes don't appear in SMART Settings.
• Minimum sleep	Type how long the interactive flat panel waits before detecting motion again (in minutes).	
• Defaults	Press to return presence detection settings to their defaults.	
• Hardware Info & Settings	Select to view information about the interactive flat panel, including its serial number and firmware and software versions.	
▶ SMART Camera		
• Preview	Press to view a preview image from the camera, select the mains power line frequency for your country (50 Hz or 60 Hz) and set the pan, tilt and zoom as appropriate for the meeting room's size.	See <i>To optimize the camera</i> on page 32.
▶ Hardware Info & Settings	Select to view information about the camera, including its serial number.	
• Additional Information	Press to view additional information about the camera.	
▶ Console for Room System		
• Calibrate	Press to calibrate the console.	
• Hardware Info & Settings	Select to view information about the console, including its serial number.	
▶ Audio Conferencing System		
▶ Hardware Info & Settings	Select to view information about the audio system, including its serial number.	
• Additional Information	Press to view additional information about the audio system.	
About Software and Product Support		
• Contact Support	Press to view contact information for SMART Support.	
• About This Software	Press to view version and legal information for the SMART software installed on the Lync appliance.	

APPENDIX A
USING THE LYNC ADMIN CONSOLE AND SMART SETTINGS

Control	Procedure	Notes (if any)
▶ Tools		
<ul style="list-style-type: none"> • Diagnostics 	Press to run SMART Board Diagnostics.	You should only run SMART Board Diagnostics in consultation with SMART Support.
Tasks		
<ul style="list-style-type: none"> • Orient/Align the SMART Product 	Press to orient the interactive flat panels.	See <i>Orienting the interactive flat panels</i> on page 62.
<ul style="list-style-type: none"> • Connection Wizard 	Press to run the connection wizard to connect, calibrate and orient the interactive flat panels.	See <i>To calibrate and orient touch on the interactive flat panels</i> on page 30.

Appendix B

Using the interactive flat panel on-screen display menu

Accessing the on-screen display menu	95
Changing settings in the on-screen display menu	96
SMART Board 8055i interactive flat panel on-screen display menu	97
SMART Board 8070i-G4 interactive flat panel on-screen display menu	102
SMART Board 8084i-G4 interactive flat panel on-screen display menu	108

You can access the on-screen display menu using either the remote control or the menu control panel.

Accessing the on-screen display menu

You can access the on-screen display menu using the remote control or the menu control panel located on the bottom of the interactive flat panel.

The remote control requires two 1.5V AAA batteries.



WARNING

To reduce the risk associated with leaking batteries:

- use only AAA type batteries
- do not mix used and new batteries
- orient the battery's plus (+) and minus (-) terminals according to the markings found on the remote control
- do not leave the batteries in the remote control for an extended period
- do not heat, disassemble, short or recharge the batteries, or expose them to fire or high temperature

- avoid eye and skin contact if batteries have leaked
- dispose of exhausted batteries and product components in accordance with applicable regulations

To replace batteries in the remote control

1. Press the tab on the underside of the remote control, and then open the cover.
2. Remove the existing batteries.
3. Insert two new 1.5V AAA batteries in the remote control.
4. Replace the cover.

Changing settings in the on-screen display menu

To change settings in the on-screen display menu

1. Press the **MENU** button on the remote control or the menu control panel.
The on-screen display menu appears.
2. Press the up and down arrows to select a menu, and then press **SET** or **OK**.
3. Press the up and down arrows to select a menu option.
4. Press the left and right arrows to change the menu option's setting.

OR

Press the right arrow to open the menu option's submenu. (Repeat steps 3 and 4 to change settings in the submenu.)

5. Press **MENU** until the on-screen menu closes.

SMART Board 8055i interactive flat panel on-screen display menu

Option	Values	Function	Notes (if any)
PICTURE			
• PICTURE MODE	STANDARD sRGB SPORT GAME USER AMBIENT DYNAMIC	Sets the picture mode	Select USER to customize brightness, contrast, sharpness and other <i>PICTURE</i> options. Select AMBIENT to set brightness based on the illuminance level of the room and to customize all other <i>PICTURE</i> options. Select one of this option's other values to set brightness, contrast, sharpness and other <i>PICTURE</i> options to default values. Alternatively, you can press the PICTURE MODE button on the remote control.
• BRIGHTNESS	0–100	Sets the overall brightness of the image and background	You can modify this option only if you select USER in <i>PICTURE MODE</i> .
• CONTRAST	0–100	Sets the brightness of the image in relation to the background	You can modify this option only if you select USER or AMBIENT in <i>PICTURE MODE</i> .
• SHARPNESS	0–100	Sets the image sharpness	You can modify this option only if you select USER or AMBIENT in <i>PICTURE MODE</i> .
• BLACK LEVEL	0–100	Sets the level of brightness in the darkest parts of the image	You can modify this option only if you select USER or AMBIENT in <i>PICTURE MODE</i> .
• TINT	0–100	Sets the image tint	You can modify this option only if you select USER or AMBIENT in <i>PICTURE MODE</i> .
• COLOR	0–100	Sets the image color depth	You can modify this option only if you select USER or AMBIENT in <i>PICTURE MODE</i> .
▶ COLOR TEMPERATURE			
• COLOR TEMPERATURE	NORMAL WARM USER COOL	Sets the color temperature	Select USER to customize the amount of red, green and blue in the image. Select one of this option's other values to set the amount of red, green and blue in the image to default values.
• RED	0–100	Sets the amount of red in the image	You can modify this option only if you select USER in <i>COLOR TEMPERATURE</i> .

APPENDIX B
USING THE INTERACTIVE FLAT PANEL ON-SCREEN DISPLAY MENU

Option	Values	Function	Notes (if any)
• GREEN	0–100	Sets the amount of green in the image	You can modify this option only if you select USER in <i>COLOR TEMPERATURE</i> .
• BLUE	0–100	Sets the amount of blue in the image	You can modify this option only if you select USER in <i>COLOR TEMPERATURE</i> .
▶ AMBIENT			
• IN BRIGHT	1–100	Sets the image brightness for brightly lit rooms	You can modify this option only if you select AMBIENT in <i>PICTURE MODE</i> . The value of this menu option can't be less than the value of <i>IN DARK</i> .
• IN DARK	0–99	Sets the image brightness for dimly lit rooms	You can modify this option only if you select AMBIENT in <i>PICTURE MODE</i> . The value of this menu option can't be more than the value of <i>IN BRIGHT</i> .
• IN BRIGHT LUX	100–1000	Sets the illuminance level for brightly lit rooms (in lux)	You can modify this option only if you select AMBIENT in <i>PICTURE MODE</i> . The value of this menu option can't be less than the value of <i>IN DARK LUX</i> .
• IN DARK LUX	50–950	Shows the illuminance level for dimly lit rooms (in lux)	You can modify this option only if you select AMBIENT in <i>PICTURE MODE</i> . The value of this menu option can't be more than the value of <i>IN BRIGHT LUX</i> .
• SENSING LUX	[N/A]	Displays the current illuminance level of the room (in lux)	This option only provides information. You're unable to modify it.
• NOISE REDUCTION	ON OFF	Enables or disables image noise reduction	This option isn't applicable to the SMART Room System. Don't change it from its default value.
• PICTURE RESET	[N/A]	Resets all options in the <i>PICTURE</i> menu to their default values	
ADJUST	The options in this menu aren't applicable to the SMART Room System.		
AUDIO	The options in this menu aren't applicable to the SMART Room System.		
OSD			
• LANGUAGE	[Languages]	Sets the on-screen display menu's language	

APPENDIX B
USING THE INTERACTIVE FLAT PANEL ON-SCREEN DISPLAY MENU

Option	Values	Function	Notes (If any)
• OSD TURN OFF	5–240	Sets the time of inactivity before the on-screen display menu turns off (in seconds)	
• OSD H-POSITION	0–100	Sets the horizontal position of the on-screen display menu	
• OSD V-POSITION	0–100	Sets the vertical position of the on-screen display menu	
• INFORMATION OSD	3–10 OFF	Specifies how long the information menu displays when a user changes the video input or presses the DISPLAY button on the remote control	
▶ MONITOR INFO			
• MODEL NAME	[N/A]	Shows the interactive flat panel's model number	This option only provides information. You're unable to modify it.
• SERIAL NUMBER	[N/A]	Shows the interactive flat panel's serial number	This option only provides information. You're unable to modify it.
• OSD TRANSPARENCY	TYPE1 TYPE2 OFF	Sets the on-screen display menu transparency	
• OSD RESET	[N/A]	Resets all options in the <i>OSD</i> menu to their default values	
SETUP			
• POWER SAVE	ON OFF	Enables or disables Power Save mode	Don't change this option from its default value.
• STANDBY MODE	STANDBY ECO STANDBY	Sets the Standby mode to reduce power consumption	Don't change this option from its default value.
• DDC CI	ENABLE DISABLE	Enables or disables two-way communication and control of the interactive flat panel	This option isn't applicable to the SMART Room System. Don't change it from its default value.
• SCAN MODE	UNDER SCAN OVER SCAN	Sets the scanning mode	This option isn't applicable to the SMART Room System. Don't change it from its default value.

APPENDIX B
USING THE INTERACTIVE FLAT PANEL ON-SCREEN DISPLAY MENU

Option	Values	Function	Notes (if any)
▶ PROXIMITY CONTROL			
• PROXIMITY	ENABLE DISABLE	Enables or disables presence detection	You can modify this option only if you select STANDBY in <i>STANDBY MODE</i> . If you change this option in SMART Settings (see page 91), the change appears in the on-screen display menu. However, if you change this option in the on-screen display menu, the change doesn't appear in SMART Settings.
• RE-ENABLE TIME	1–10	Sets how long the interactive flat panel waits before detecting motion again (in minutes)	You can modify this option only if you select ENABLE in <i>PROXIMITY</i> . If you change this option in SMART Settings (see page 91), the change appears in the on-screen display menu. However, if you change this option in the on-screen display menu, the change doesn't appear in SMART Settings.
• AUTO POWER OFF	15–240	Sets when the interactive flat panel automatically turns off (in minutes)	You can modify this option only if you select ENABLE in <i>PROXIMITY</i> .
• BRIGHTNESS	0–100	Sets the brightness of the welcome screen	This option isn't applicable to the SMART Room System. Don't change it from its default value.
▶ HEAT STATUS			
• FAN1	[N/A]	Shows the status of the first fan	This option only provides information. You're unable to modify it.
• FAN2	[N/A]	Shows the status of the second fan	This option only provides information. You're unable to modify it.
• SENSOR1	[N/A]	Shows the temperature reading from the first sensor	This option only provides information. You're unable to modify it.
• SENSOR2	[N/A]	Shows the temperature reading from the second sensor	This option only provides information. You're unable to modify it.
▶ FAN CONTROL			
• COOLING FAN	ON AUTO	Sets the fan to run continuously (ON) or only when the sensor temperature is greater than optimal sensor temperature (AUTO)	
• FAN SPEED	LOW HIGH	Sets the speed of the fan	

APPENDIX B
USING THE INTERACTIVE FLAT PANEL ON-SCREEN DISPLAY MENU

Option	Values	Function	Notes (if any)
• SENSOR1	35–55	Sets the optimal temperatures for the first sensor (in degrees Celsius)	
• SENSOR2	35–55	Sets the optimal temperatures for the second sensor (in degrees Celsius)	
▶ USB SETTING			
• USB1	VGA1 VGA2 DVI DPORT HDMI1 HDMI2 DISABLE	Sets the video input for the USB1 receptacle, or disables the receptacle	This option isn't applicable to the SMART Room System. Don't change it from its default value.
• USB2	VGA1 VGA2 DVI DPORT HDMI1 HDMI2 DISABLE	Sets the video input for the USB2 receptacle, or disables the receptacle	This option isn't applicable to the SMART Room System. Don't change it from its default value.
• USB3	VGA1 VGA2 DVI DPORT HDMI1 HDMI2 DISABLE	Sets the video input for the USB3 receptacle, or disables the receptacle	This option isn't applicable to the SMART Room System. Don't change it from its default value.
• SETUP RESET	[N/A]	Resets all options in the <i>SETUP</i> menu to their default values	This option isn't applicable to the SMART Room System. Don't change it from its default value.
• FACTORY RESET	[N/A]	Resets options in all menus to their default values	This option isn't applicable to the SMART Room System. Don't change it from its default value.

SMART Board 8070i-G4 interactive flat panel on-screen display menu

Option	Values	Function	Notes (if any)
PICTURE			
• PICTURE MODE	STANDARD CINEMA/sRGB SPORT GAME USER AMBIENT DYNAMIC	Sets the picture mode	Select USER to customize brightness, contrast, sharpness and other <i>PICTURE</i> options. Select AMBIENT to set brightness based on the illuminance level of the room and to customize all other <i>PICTURE</i> options. Select one of this option's other values to set brightness, contrast, sharpness and other <i>PICTURE</i> options to default values. Alternatively, you can press the PICTURE MODE button on the remote control.
• BRIGHTNESS	0–100	Sets the overall brightness of the image and background	You can modify this option only if you select USER in <i>PICTURE MODE</i> .
• CONTRAST	0–100	Sets the brightness of the image in relation to the background	You can modify this option only if you select USER or AMBIENT in <i>PICTURE MODE</i> .
• SHARPNESS	0–100	Sets the image sharpness	You can modify this option only if you select USER or AMBIENT in <i>PICTURE MODE</i> .
• BLACK LEVEL	0–100	Sets the level of brightness in the darkest parts of the image	You can modify this option only if you select USER or AMBIENT in <i>PICTURE MODE</i> .
• TINT	0–100	Sets the image tint	You can modify this option only if you select USER or AMBIENT in <i>PICTURE MODE</i> .
• COLOR	0–100	Sets the image color depth	You can modify this option only if you select USER or AMBIENT in <i>PICTURE MODE</i> .
▶ COLOR TEMPERATURE			
• COLOR TEMPERATURE	NORMAL WARM USER COOL	Sets the color temperature	Select USER to customize the amount of red, green and blue in the image. Select one of this option's other values to set the amount of red, green and blue in the image to default values.
• RED	0–100	Sets the amount of red in the image	You can modify this option only if you select USER in <i>COLOR TEMPERATURE</i> .

APPENDIX B
USING THE INTERACTIVE FLAT PANEL ON-SCREEN DISPLAY MENU

Option	Values	Function	Notes (if any)
• GREEN	0–100	Sets the amount of green in the image	You can modify this option only if you select USER in <i>COLOR TEMPERATURE</i> .
• BLUE	0–100	Sets the amount of blue in the image	You can modify this option only if you select USER in <i>COLOR TEMPERATURE</i> .
▶ AMBIENT			
• IN BRIGHT	1–100	Sets the image brightness for brightly lit rooms	You can modify this option only if you select AMBIENT in <i>PICTURE MODE</i> . The value of this menu option can't be less than the value of <i>IN DARK</i> .
• IN DARK	0–99	Sets the image brightness for dimly lit rooms	You can modify this option only if you select AMBIENT in <i>PICTURE MODE</i> . The value of this menu option can't be more than the value of <i>IN BRIGHT</i> .
• IN BRIGHT LUX	100–1000	Sets the illuminance level for brightly lit rooms (in lux)	You can modify this option only if you select AMBIENT in <i>PICTURE MODE</i> . The value of this menu option can't be less than the value of <i>IN DARK LUX</i> .
• IN DARK LUX	50–950	Shows the illuminance level for dimly lit rooms (in lux)	You can modify this option only if you select AMBIENT in <i>PICTURE MODE</i> . The value of this menu option can't be more than the value of <i>IN BRIGHT LUX</i> .
• SENSING LUX	[N/A]	Displays the current illuminance level of the room (in lux)	This option only provides information. You're unable to modify it.
• NOISE REDUCTION	ON OFF	Enables or disables image noise reduction	You can modify this option only if the currently selected video input is S-Video or component video.
• PICTURE RESET	[N/A]	Resets all options in the <i>PICTURE</i> menu to their default values	
ADJUST	The options in this menu aren't applicable to the SMART Room System.		
AUDIO			
• BALANCE	L50–R50	Balances the left and right volume	This option isn't applicable to the SMART Room System. Don't change it from its default value.

APPENDIX B
USING THE INTERACTIVE FLAT PANEL ON-SCREEN DISPLAY MENU

Option	Values	Function	Notes (if any)
• TREBLE	L50–R50	Sets the high frequency sound	This option isn't applicable to the SMART Room System. Don't change it from its default value.
• BASS	L50–R50	Sets the low frequency sound	This option isn't applicable to the SMART Room System. Don't change it from its default value.
• LINE OUT	FIXED VARIABLE	Sets the audio line out	Don't change this option from its default value.
• HDMI3/PC LINE OUT	FIXED VARIABLE	Sets the audio line out for the room computer (HDMI3/PC)	Don't change this option from its default value.
• AUDIO INPUT	DPORT USB IN1 IN2 IN3 HDMI3/PC ANALOG HDMI3/PC DIGITAL	Sets the audio input source	Alternatively, you can press the AUDIO INPUT button on the remote control. This option should be set to IN2 for the SMART Room System.
• LEFT SPEAKER	ON OFF	Enables or disables the left speaker	Don't change this option from its default value.
• RIGHT SPEAKER	ON OFF	Enables or disables the right speaker	Don't change this option from its default value.
• AUDIO RESET	[N/A]	Resets all options in the <i>AUDIO</i> menu to their default values	This option isn't applicable to the SMART Room System. Don't change it from its default value.
OSD			
• LANGUAGE	[Languages]	Sets the on-screen display menu's language	
• OSD TURN OFF	5–240	Sets the time of inactivity before the on-screen display menu turns off (in seconds)	
• OSD H-POSITION	0–100	Sets the horizontal position of the on-screen display menu	
• OSD V-POSITION	0–100	Sets the vertical position of the on-screen display menu	
• INFORMATION OSD	3–10 OFF	Specifies how long the information menu displays when a user changes the video input or presses the DISPLAY button on the remote control	

APPENDIX B
USING THE INTERACTIVE FLAT PANEL ON-SCREEN DISPLAY MENU

Option	Values	Function	Notes (if any)
▶ MONITOR INFO			
• MODEL NAME	[N/A]	Shows the interactive flat panel's model number	This option only provides information. You're unable to modify it.
• SERIAL NUMBER	[N/A]	Shows the interactive flat panel's serial number	This option only provides information. You're unable to modify it.
• OSD TRANSPARENCY	TYPE1 TYPE2 OFF	Sets the on-screen display menu transparency	
• OSD RESET	[N/A]	Resets all options in the <i>OSD</i> menu to their default values	
SETUP			
• POWER SAVE	ON OFF	Enables or disables Power Save mode	Don't change this option from its default value.
• STANDBY MODE	STANDBY ECO STANDBY	Sets the Standby mode to reduce power consumption	Don't change this option from its default value.
• DDC CI	ENABLE DISABLE	Enables or disables two-way communication and control of the interactive flat panel	This option isn't applicable to the SMART Room System. Don't change it from its default value.
• SCAN MODE	UNDER SCAN OVER SCAN	Sets the scanning mode	This option isn't applicable to the SMART Room System. Don't change it from its default value.
• FBC CONTROL	ENABLE DISABLE	Enables or disables the front control panel	Don't change this option from its default value.
• MONITOR ID	1–100	Sets the interactive flat panel's ID	This option isn't applicable to the SMART Room System. Don't change it from its default value.
▶ PROXIMITY CONTROL			
• PROXIMITY	ENABLE DISABLE	Enables or disables presence detection	You can modify this option only if you select STANDBY in STANDBY MODE . If you change this option in SMART Settings (see page 91), the change appears in the on-screen display menu. However, if you change this option in the on-screen display menu, the change doesn't appear in SMART Settings.

APPENDIX B
USING THE INTERACTIVE FLAT PANEL ON-SCREEN DISPLAY MENU

Option	Values	Function	Notes (if any)
• RE-ENABLE TIME	1–10	Sets how long the interactive flat panel waits before detecting motion again (in minutes)	You can modify this option only if you select ENABLE in <i>PROXIMITY</i> . If you change this option in SMART Settings (see page 91), the change appears in the on-screen display menu. However, if you change this option in the on-screen display menu, the change doesn't appear in SMART Settings.
• AUTO POWER OFF	15–240	Sets when the interactive flat panel automatically turns off (in minutes)	You can modify this option only if you select ENABLE in <i>PROXIMITY</i> .
• BRIGHTNESS	0–100	Sets the brightness of the welcome screen	This option isn't applicable to the SMART Room System. Don't change it from its default value.
• CEC	ENABLE DISABLE	Enables or disables Consumer Electronics Control (CEC) support on HDMI inputs	This option isn't applicable to the SMART Room System. Don't change it from its default value.
▶ HEAT STATUS			
• FAN1	[N/A]	Shows the status of the first fan	This option only provides information. You're unable to modify it.
• FAN2	[N/A]	Shows the status of the second fan	This option only provides information. You're unable to modify it.
• SENSOR1	[N/A]	Shows the temperature reading from the first sensor	This option only provides information. You're unable to modify it.
• SENSOR2	[N/A]	Shows the temperature reading from the second sensor	This option only provides information. You're unable to modify it.
▶ FAN CONTROL			
• COOLING FAN	ON AUTO	Sets the fan to run continuously (ON) or only when the sensor temperature is greater than optimal sensor temperature (AUTO)	
• FAN SPEED	LOW HIGH	Sets the speed of the fan	
• SENSOR1	35–55	Sets the optimal temperatures for the first sensor (in degrees Celsius)	
• SENSOR2	35–55	Sets the optimal temperatures for the second sensor (in degrees Celsius)	

APPENDIX B
USING THE INTERACTIVE FLAT PANEL ON-SCREEN DISPLAY MENU

Option	Values	Function	Notes (If any)
▶ USB SETTING			
<ul style="list-style-type: none"> • USB1 	VGA1 VGA2 DVI HDMI1 HDMI2 HDMI3/PC DISABLE	Sets the video input for the USB1 receptacle or disables the receptacle	This option isn't applicable to the SMART Room System. Don't change it from its default value.
<ul style="list-style-type: none"> • USB2 	VGA1 VGA2 DVI HDMI1 HDMI2 HDMI3/PC DISABLE	Sets the video input for the USB2 receptacle or disables the receptacle	This option isn't applicable to the SMART Room System. Don't change it from its default value.
<ul style="list-style-type: none"> • SETUP RESET 	[N/A]	Resets all options in the <i>SETUP</i> menu to their default values	This option isn't applicable to the SMART Room System. Don't change it from its default value.
<ul style="list-style-type: none"> • Lync® ROOM RESET 	[N/A]	Resets options in all menus to their default values (for SMART Room Systems)	You use this option when you first configure the SMART Room System (see <i>Starting your room system for the first time</i> on page 18).
<ul style="list-style-type: none"> • FACTORY RESET 	[N/A]	Resets options in all menus to their default values	This option isn't applicable to the SMART Room System. Don't change it from its default value.

SMART Board 8084i-G4 interactive flat panel on-screen display menu

Option	Values	Function	Notes (If any)
PICTURE			
▶ Picture Mode			
▶ Picture Mode	Vivid Standard Ambient Expert1 Expert2	Sets the picture mode	SMART recommends that this option be set to Standard . The other options in the <i>Picture Mode</i> menu change depending on which value you select for this option. The options documented in this table are those that appear when you select Vivid , Standard or Ambient in this option. Alternatively, you can press the PSM button on the remote control to access this option.
• In Bright	1–100	Sets the image brightness for brightly lit rooms	You can modify this option only if you select Ambient in <i>Picture Mode</i> . The value of this menu option can't be less than the value of <i>In Dark</i> .
• In Dark	0–99	Sets the image brightness for dimly lit rooms	You can modify this option only if you select Ambient in <i>Picture Mode</i> . The value of this menu option can't be more than the value of <i>In Bright</i> .
• Light Threshold	[Number]	Sets the light threshold	You can modify this option only if you select Ambient in <i>Picture Mode</i> .
• Sensing Lux	[N/A]	Shows the current illuminance level of the room (in lux)	This option only provides information. You're unable to modify it.
• Backlight	0–100	Sets the backlight level of the image	SMART recommends that this option be set to 100 .
• Contrast	0–100	Sets the brightness of the image in relation to the background	SMART recommends that this option be set to 84 .
• Brightness	0–100	Sets the overall brightness of the image and background	SMART recommends that this option be set to 63 . Alternatively, you can press the BRIGHTNESS buttons on the remote control.
• Sharpness	0–50	Sets the image sharpness	SMART recommends that this option be set to 0 .

APPENDIX B
USING THE INTERACTIVE FLAT PANEL ON-SCREEN DISPLAY MENU

Option	Values	Function	Notes (If any)
• Saturation	0–100	Sets the image saturation	SMART recommends that this option be set to 55 .
• Tint	R50–G50	Sets the image tint	SMART recommends that this option be set to 0 .
• Color Temp.	W50–C50	Sets the image color temperature	SMART recommends that this option be set to 0 .
▶ Advanced Control			
• Dynamic Contrast	Low Medium High Off	Sets the dynamic contrast	SMART recommends that this option be disabled.
• Dynamic Color	Low High Off	Sets the dynamic color	SMART recommends that this option be disabled
• Clear White	Low High Off	Sets the clear white color	SMART recommends that this option be disabled.
▶ Preferred color			
• Skin Color	-5–5	Sets the preferred color value for skin in the image	
• Grass Color	-5–5	Sets the preferred color value for grass in the image	
• Sky Color	-5–5	Sets the preferred color value for sky in the image	
• Super Resolution	On Off	Enables or disables super resolution	
• Gamma	Low Medium Hight	Sets the gamma	SMART recommends that this option be set to Low .
▶ Picture Option			
• Noise Reduction	Low Medium High Off	Sets image noise reduction	SMART recommends that this option be disabled.
• MPEG Noise Reduction	Low Medium High Off	Sets MPEG image noise reduction	SMART recommends that this option be disabled.
• Black Level	High Low	Sets the level of brightness in the darkest parts of the image	SMART recommends that this option be set to Low .

APPENDIX B
USING THE INTERACTIVE FLAT PANEL ON-SCREEN DISPLAY MENU

Option	Values	Function	Notes (If any)
<ul style="list-style-type: none"> LED Local Dimming 	Low Medium High	Sets the level of LED local dimming to reduce brightness in the darkest parts of the image	SMART recommends that this option be disabled.
▶ TruMotion			
<ul style="list-style-type: none"> TruMotion 	Smooth Clear Clear Plus User Off	Sets TruMotion	SMART recommends that this option be set to Smooth .
<ul style="list-style-type: none"> De-Judder 	0–10	Reduces image juddering	You can modify this option only if you select User in <i>TruMotion</i> .
<ul style="list-style-type: none"> De-Blur 	0–10	Reduces image blurring	You can modify this option only if you select User in <i>TruMotion</i> .
<ul style="list-style-type: none"> Picture Reset 	Yes No	Resets all options in the <i>Picture Mode</i> menu to their default values	
<ul style="list-style-type: none"> Aspect Ratio 	16:9 Just Scan Set By Program 4:3 Zoom Cinema Zoom 1	Sets the aspect ratio	Don't change this option from its default value.
<ul style="list-style-type: none"> Picture Wizard II 	[N/A]	Starts Picture Wizard II, which you can use to adjust the picture quality of the original image	
<ul style="list-style-type: none"> Screen 	[N/A]	Shows the current input type	This option only provides information. You're unable to modify it.
SOUND			
<ul style="list-style-type: none"> Sound Mode 	Standard User Setting	Sets the sound mode	This option isn't applicable to the SMART Room System. Don't change it from its default value.
<ul style="list-style-type: none"> Virtual Surround 	On Off	Enables or disables virtual surround sound	This option isn't applicable to the SMART Room System. Don't change it from its default value.
▶ Clear Voice II			
<ul style="list-style-type: none"> Clear Voice II 	On Off	Enables or disables the Clear Voice II feature	This option isn't applicable to the SMART Room System. Don't change it from its default value.
▶ AV Sync.			
<ul style="list-style-type: none"> AV Sync. 	On Off	Enables or disables audio-visual synchronization	This option isn't applicable to the SMART Room System. Don't change it from its default value.

APPENDIX B
USING THE INTERACTIVE FLAT PANEL ON-SCREEN DISPLAY MENU

Option	Values	Function	Notes (if any)
• Speaker	-5–15	Sets the speaker level for audio-visual synchronization	This option isn't applicable to the SMART Room System. Don't change it from its default value.
• Bypass	[N/A]	Enables or disables speaker bypass	This option isn't applicable to the SMART Room System. Don't change it from its default value.
▶ Sound Setting			
• Balance	L50–R50	Balances the left and right volume	This option isn't applicable to the SMART Room System. Don't change it from its default value.
• Speaker	Internal External Off	Enables the internal speakers, enables the external speakers or disables audio altogether	Don't change this option from its default value.
• Line Output	Fixed Variable	Sets the audio line out	Don't change this option from its default value.
• HDMI3/PC Line Output	Fixed Variable	Sets the audio line out for the room computer (HDMI3/PC)	Don't change this option from its default value.
▶ Audio Input			
• Audio In 1	HDMI3/PC HDMI1 HDMI2 DPORT DVI-D VGA Component Composite Disable	Specifies a video input to map to AUDIO1 or disables AUDIO1	This option isn't applicable to the SMART Room System. Don't change it from its default value.
• Audio In 2	HDMI3/PC HDMI1 HDMI2 DPORT DVI-D VGA Component Composite Disable	Specifies a video input to map to AUDIO2 or disables AUDIO2	This option should be set to HDMI3/PC for the SMART Room System.

APPENDIX B
USING THE INTERACTIVE FLAT PANEL ON-SCREEN DISPLAY MENU

Option	Values	Function	Notes (if any)
<ul style="list-style-type: none"> Audio In 3 	HDMI3/PC HDMI1 HDMI2 DPORT DVI-D VGA Component Composite Disable	Specifies a video input to map to AUDIO3 or disables AUDIO3	This option isn't applicable to the SMART Room System. Don't change it from its default value.
<ul style="list-style-type: none"> USB Audio 	HDMI3/PC HDMI1 HDMI2 DPORT DVI-D VGA Component Composite Disable	Specifies a video input to map to the USB audio input or disables the USB audio input	This option isn't applicable to the SMART Room System. Don't change it from its default value.
<ul style="list-style-type: none"> HDMI3/PC 	Analog Digital	Specifies whether the HDMI3/PC audio input is analog or digital	This option should be set to Analog for the SMART Room System.
TIME			
▶ Clock			
<ul style="list-style-type: none"> Date 	1–31	Specifies the current date	
<ul style="list-style-type: none"> Month 	Jan.–Dec.	Specifies the current month	
<ul style="list-style-type: none"> Year 	2010–2040	Specifies the current year	
<ul style="list-style-type: none"> Hour 	00–23	Specifies the current hour	
<ul style="list-style-type: none"> Minute 	00–59	Specifies the current minute	
<ul style="list-style-type: none"> Off Time 	[N/A]	Enables you to schedule times when the interactive flat panel turns off automatically	This option isn't applicable to the SMART Room System. Don't change it from its default value.
<ul style="list-style-type: none"> On Time 	[N/A]	Enables you to schedule times when the interactive flat panel turns on automatically	This option isn't applicable to the SMART Room System. Don't change it from its default value.
<ul style="list-style-type: none"> Sleep Timer 	10–240 Off	Specifies the amount of inactivity (in minutes) before the interactive flat panel turns off or disables the sleep timer feature	This option isn't applicable to the SMART Room System. Don't change it from its default value.
OPTION			
<ul style="list-style-type: none"> Language 	[Languages]	Sets the on-screen display menu's language	

APPENDIX B
USING THE INTERACTIVE FLAT PANEL ON-SCREEN DISPLAY MENU

Option	Values	Function	Notes (if any)
• ISM Method	Normal Color Wash	Sets the method for image stickiness minimization (ISM)	ISM prevents static images that appear in the same location for long periods of time from causing screen burn-in.
• Key Lock	On Off	Enables or disables key lock	
▶ Fail Over			
• Mode	Off Auto Manual	Enables or disables fail over mode	This option isn't applicable to the SMART Room System. Don't change it from its default value.
• DPM Select	On Off	Enables or disables DPM Select	This option isn't applicable to the SMART Room System. Don't change it from its default value.
• DivX® VOD	Registration Deregistration	Registers DivX video-on-demand (VOD)	This option isn't applicable to the SMART Room System. Don't change it from its default value.
• Initial Setting	Yes No	Resets options in all menus to their default values	This option isn't applicable to the SMART Room System. Don't change it from its default value.
• Set ID	1–255	Sets the interactive flat panel's ID	This option isn't applicable to the SMART Room System. Don't change it from its default value.
• Standby Mode	Standby	Sets the Standby mode to reduce power consumption	This option isn't applicable to the SMART Room System. Don't change it from its default value.
▶ Proximity Control			
• Proximity Control	On Off	Enables or disables presence detection	If you change this option in SMART Settings (see page 91), the change appears in the on-screen display menu. However, if you change this option in the on-screen display menu, the change doesn't appear in SMART Settings.
• Re-enable Time	1–10	Sets how long the interactive flat panel waits before detecting motion again (in minutes)	If you change this option in SMART Settings (see page 91), the change appears in the on-screen display menu. However, if you change this option in the on-screen display menu, the change doesn't appear in SMART Settings.
• Auto Power Off	15–240	Sets when the interactive flat panel automatically turns off (in minutes)	
• Welcome OSD	Enabled Disable	Enables or disables the welcome screen	This option isn't applicable to the SMART Room System. Don't change it from its default value.

APPENDIX B
USING THE INTERACTIVE FLAT PANEL ON-SCREEN DISPLAY MENU

Option	Values	Function	Notes (If any)
<ul style="list-style-type: none"> Welcome Timeout 	5–30	Sets how long the welcome screen appears (in seconds)	This option isn't applicable to the SMART Room System. Don't change it from its default value.
<ul style="list-style-type: none"> Ready State Brightness 	0–100	Sets the brightness of the welcome screen	This option isn't applicable to the SMART Room System. Don't change it from its default value.
▶ USB Setting			
<ul style="list-style-type: none"> USB 1 	HDMI1 HDMI2 HDMI3/PC DVI-D DPORT VGA Disable	Sets the video input for the USB1 receptacle, or disables the receptacle	Don't change this option from its default value.
<ul style="list-style-type: none"> USB 2 	HDMI1 HDMI2 HDMI3/PC DVI-D DPORT VGA Disable	Sets the video input for the USB2 receptacle, or disables the receptacle	This option isn't applicable to the SMART Room System. Don't change it from its default value.
<ul style="list-style-type: none"> USB 3 	HDMI1 HDMI2 HDMI3/PC DVI-D DPORT VGA Disable	Sets the video input for the USB3 receptacle, or disables the receptacle	This option isn't applicable to the SMART Room System. Don't change it from its default value.
<ul style="list-style-type: none"> Lync® Room Reset 	Reset Cancel	Resets options in all menus to their default values (for SMART Room Systems)	You use this option when you first configure the SMART Room System (see <i>Starting your room system for the first time</i> on page 18).
<ul style="list-style-type: none"> CEC 	Enabled Disable	Enables or disables Consumer Electronics Control (CEC) support on HDMI inputs	This option isn't applicable to the SMART Room System. Don't change it from its default value.
<ul style="list-style-type: none"> FBC Control 	On Off	Enables or disables the front control panel	Don't change this option from its default value.
SUPPORT			
<ul style="list-style-type: none"> Model/Type 	[N/A]	Shows the interactive flat panel's model number	This option only provides information. You're unable to modify it.

APPENDIX B
USING THE INTERACTIVE FLAT PANEL ON-SCREEN DISPLAY MENU

Option	Values	Function	Notes (If any)
• Software Version	[N/A]	Shows the interactive flat panel's firmware version number	This option only provides information. You're unable to modify it.
• Serial Number	[N/A]	Shows the interactive flat panel's serial number	This option only provides information. You're unable to modify it.
• Customer Service Center	[N/A]	Provides information on how to contact SMART Support	This option only provides information. You're unable to modify it.

Appendix C

Remotely managing your room system using Intel AMT

Configuring your room system	118
Remotely managing your room system	121
Using the embedded web management interface	121
Using management software	121
Using remote access software	121
Security	123
Ports	123
Intel MEBx controls	124
References	128

Intel AMT is part of Intel vPro® technology, which is used in your SMART Room System’s Lync appliance.

You can use Intel AMT to remotely manage your room system. Before you can use Intel AMT, you must first enable and configure it on the Lync appliance. You can then connect to the room system and manage it remotely by using one of the following:

- The embedded web management interface
- Management software, such as Open MDTK
- Remote access software, such as DameWare® or VNC® Viewer Plus

This appendix explains how to configure your room system for Intel AMT and how to use Intel AMT to remotely manage the room system.



IMPORTANT

- Set an administrator password for the BIOS (under **Security > Administrator Password**) and change the Intel Management Engine BIOS Extension (MEBx) password from the default to prevent users from making configuration changes to Intel AMT.
- Store the BIOS and Intel MEBx passwords in a safe place because these passwords cannot be easily reset if lost.

Configuring your room system

Before you can remotely manage your room system using Intel AMT, you need to enable Intel AMT and then configure it.

To enable Intel AMT

1. Turn off your room system (see *Turning off your room system* on page 57).
2. Connect a USB keyboard to the Lync appliance.
3. Turn on the room system by completing the appropriate procedure for the room size:

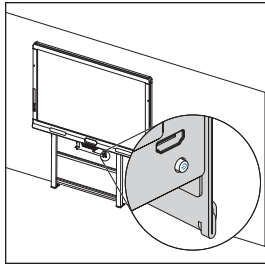
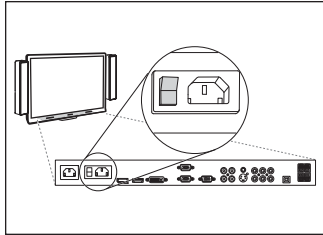
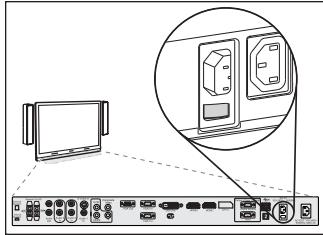
Room size	Procedure
Extra small room	<p>a. Press the power button on the Lync appliance enclosure.</p>  <p>b. Flick the power switch on the bottom of the interactive flat panel.</p> 
Small room	<p>Flick the power switch on the bottom of the interactive flat panel.</p> 

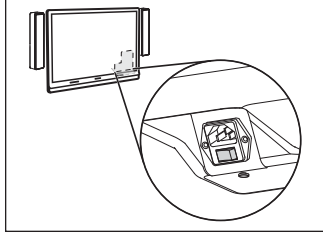
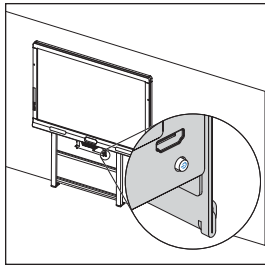
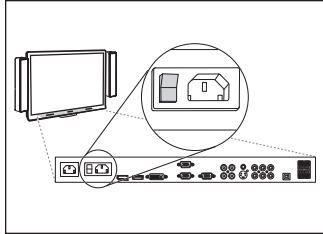
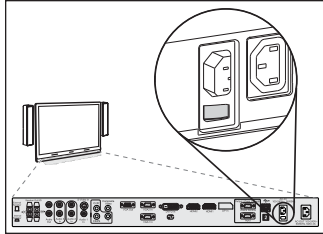
Room size	Procedure
Medium room	Flick the power switch on the bottom of the interactive flat panel. 
Medium room with dual panels	a. Press the power button on the Lync appliance enclosure.  b. Flick the power switch on the bottom of both interactive flat panels. 
Large room	Flick the power switch on the bottom of both interactive flat panels. 

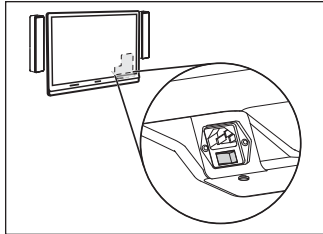
Room size	Procedure
Extra large room	Flick the power switch on the bottom of both interactive flat panels. 

4. Press the DELETE key.
The Lync appliance enters BIOS mode.
5. Browse to the **Advanced** tab.
6. Select **AMT Configuration**, and then press ENTER.
7. Set *Intel AMT* to **Enabled**.
8. Press ESC.
9. Browse to the **Save & Exit** tab.
10. Select **Save Changes and Exit**, and then select **Yes**.
The room system restarts.
11. Press CTRL+P before the Windows startup screen appears.
Intel MEBx opens.
12. Continue to the next procedure.

To configure Intel AMT

1. Enter the default Intel AMT password (**admin**) when prompted, and then change the Intel AMT password following the on-screen instructions.
2. Select **Intel® AMT Configuration**, and then press ENTER.
3. Select **Activate Network Access**, and then press ENTER.
4. Press Y.



NOTE

For information on other MEBx controls, see *Intel MEBx controls* on page 124.

5. Select **MEBX Exit**, and then select **Y**.

The room system restarts.

Remotely managing your room system

After you configure your room system for Intel AMT, you can connect to it and manage it remotely.

Using the embedded web management interface

Your room system's Lync appliance includes an embedded web page for the administration of Intel AMT:

`http://[Your room system's IP address or fully qualified domain name (FQDN)]:16992`

The room system must be connected to a power source and the network to manage it remotely. However, it doesn't need to be running. Using the web page, you can do the following remotely:

- Restart the room system
- Turn off the room system
- Start the room system in BIOS mode
- Manage local system user accounts and rights (not operating system user accounts)

Using management software

Open MDTK (opentools.homeip.net/open-manageability) is open source management software that provides robust administration tools for your room system and other Intel AMT devices. Open MDTK enables you to view installed Intel AMT security certificates, assess the room system's Intel AMT capabilities, enable or disable the embedded web management interface, change Intel AMT IP addresses, enable advanced IP settings, edit Intel AMT user accounts, completely disable remote Intel AMT capabilities on a target system, and more. Open MDTK doesn't include remote access software, but you can use it to launch VNC Viewer Plus (see *Using remote access software* below).

For additional management software that works with Intel vPro technology, see msp.intel.com/management-consoles.

Using remote access software

The following procedures show how to connect to your room system using DameWare and VNC Viewer Plus. However, you can connect to your room system using any remote access software that supports Intel AMT Keyboard Video Mouse (KVM) connections.

After you connect to your room system, you can perform all of the administrative tasks described in this guide, including restarting the room system in administrator mode and making configuration changes in Lync Admin Console and SMART Settings.

 **NOTE**

When you connect to a room system using remote access software, an orange and yellow border appears around the room system's screens and an icon flashes in the top-right corner to indicate to anyone in the room that you're accessing the room system remotely.

 **To connect to your room system using DameWare**

1. Start DameWare.
2. Click **Connect**.
The *Remote Connect* window opens.
3. Type the IP address for the room system in the *Host* box.
4. Type admin in the *User ID* box.
5. Type the Intel AMT password you specified in *To configure Intel AMT* on page 120 in the *Password* box.
6. Select **Use Intel AVT KVM**.
7. Click **Connect**.
8. Press F1, and then press ENTER to select the room system display you want to view.

 **NOTE**

If you want to view a different display, you must disconnect from the room system and then connect to it again.

 **To connect to your room system using VNC Viewer Plus**





1. Start VNC Viewer Plus.
2. Select **None** in the *Encryption* drop-down list.
3. Select **Intel® AVT KVM** in the *Connection Mode* drop-down list.
4. Click **Connect**.
5. Type the Intel AMT user name (**admin**) and password you specified in *To configure Intel AMT* on page 120 when prompted.
6. Press F1, and then press ENTER to select the room system display you want to view.

Security

Intel AMT remote communications are secured by TLS, which is a protocol that secures and authenticates communications across a public network. For more information, see *References* on page 128.

Ports

Ensure the following ports are open for use by Intel AMT:

Port	Description	Use
16992	Intel AMT HTTP	WS-Management messages to and from Intel AMT  NOTE This port is open over the network only when Intel AMT is configured or during the configuration process. Starting with version 6.0, the port is optionally open when TLS is enabled. The port is always open locally.
16993	Intel AMT HTTPS	WS-Management messages to and from Intel AMT when TLS is enabled
16994	Intel AMT redirection/TCP	Redirection traffic—Serial Over LAN (SOL), IDE Redirection (IDER) and Intel KVM using Intel AMT authentication  NOTE Enabling the redirection listener enables this port.
16995	Intel AMT redirection/TLS	Redirection traffic—SOL, IDER and Intel KVM using Intel AMT authentication—when TLS is enabled  NOTE Enabling the redirection listener enables this port.
623	ASF Remote Management and Control Protocol (ASF-RMCP)	RMCP pings  NOTE This port is a standard DMTF port and accepts WS-Management traffic. It's always enabled.

Port	Description	Use
664	DMTF out-of-band secure web services management protocol Secure ASF-RMCP	Secure RMCP pings
<div style="background-color: #f0f0f0; padding: 5px;">  NOTE This port is a standard DMTF port and accepts WS-Management traffic. It's always enabled. </div>		
5900	Virtual Network Computing (VNC) remote control program	KVM viewers that don't use Intel AMT authentication but use the standard VNC port instead

Intel MEBx controls

The following are the controls in Intel MEBx:

Control	Procedure	Notes (if any)
Intel® ME General Settings		
<ul style="list-style-type: none"> Change ME Password 	Type a new Intel AMT password.	The default password is admin . When you first open Intel MEBx, you're prompted to change the password. SMART recommends not changing this control from its default setting.
<ul style="list-style-type: none"> Local FW Update 	Select Enabled to enable local firmware updates. OR Select Disabled to disable local firmware updates. OR Select Password Protected to protect local firmware updates using the Intel AMT password.	SMART recommends not changing this control from its default setting.
▶ Power Control		
<ul style="list-style-type: none"> Intel® ME ON in Host Sleep Status 	Select a power package.	SMART recommends not changing this control from its default setting.
<ul style="list-style-type: none"> Idle Timeout 	Type the idle timeout (in minutes).	SMART recommends not changing this control from its default setting.

APPENDIX C
REMOTELY MANAGING YOUR ROOM SYSTEM USING INTEL AMT

Control	Procedure	Notes (if any)
Intel® AMT Configuration		
<ul style="list-style-type: none"> Manageability Feature Selection 	Select Enabled .	You must enable manageability feature selection to remotely manage your room system using Intel AMT.
▶ SOL/IDER/KVM		
<ul style="list-style-type: none"> User Name and Password 	Select Enabled to require user authentication for Serial Over LAN/IDE Redirection (SOL/IDER) sessions.	
<ul style="list-style-type: none"> SOL 	Select Enabled to allow the room system's input/output to be redirected to a management server console.	
<ul style="list-style-type: none"> IDER 	Select Enabled to allow the room system to be booted by a management console from a remote disk image.	
<ul style="list-style-type: none"> KVM Feature Selection 	Select Enabled to enable Intel KVM.	
<ul style="list-style-type: none"> Legacy Redirection Mode 	Select Enabled to leave the port open at all times when redirection is enabled in Intel MEBx.	
▶ User Consent		
<ul style="list-style-type: none"> User Opt-in 	Select KVM to require local user consent for Intel KVM remote control. OR Select None to not require local user consent.	This control doesn't affect your room system. If you enable user opt-in for Intel KVM, users are prompted with a key code. The users must provide this key code to the administrator who is attempting to remotely connect to the room system.
<ul style="list-style-type: none"> Opt-in Configurable from Remote IT 	Select Enabled to allow remote users to change the user opt-in policy.	

APPENDIX C
REMOTEY MANAGING YOUR ROOM SYSTEM USING INTEL AMT

Control	Procedure	Notes (if any)
<ul style="list-style-type: none"> Password Policy 	<p>Select Default Password Only to allow changing the Intel AMT password from the network interface if the default password hasn't been changed yet.</p> <p>OR</p> <p>Select During Setup and Configuration to allow changing the Intel AMT password from the network interface during only setup and configuration.</p> <p>OR</p> <p>Select Anytime to allow changing the Intel AMT password from the network interface at any time.</p>	
▶ Network Setup		
▶ Intel® ME Network Name Settings		
<ul style="list-style-type: none"> Host Name 	Type the host name for Intel AMT.	If you configure a set host name, ensure it mirrors the Windows operating system's host name to ensure stability.
<ul style="list-style-type: none"> Domain Name 	Type the domain name for Intel AMT.	
<ul style="list-style-type: none"> Shared/Dedicated FQDN 	<p>Select Shared to use an FQDN that is shared with the host.</p> <p>OR</p> <p>Select Dedicated to use a dedicated FQDN for Intel MEBx.</p>	
<ul style="list-style-type: none"> Dynamic DNS Update 	<p>Select Enabled to enable the firmware to actively register its IP address and FQDN on the domain name system (DNS) using the Dynamic DNS (DDNS) Update protocol.</p> <p>OR</p> <p>Select Disabled to disable this feature.</p>	
<ul style="list-style-type: none"> Period Update Interval 	Type the interval (in minutes) at which the firmware DDNS Update client sends period updates.	This control is only available if you enable Dynamic DNS Update.
<ul style="list-style-type: none"> TTS 	Type how long (in seconds) the record should not be scavenged in DNS server.	This control is only available if you enable Dynamic DNS Update.
▶ TCP/IP Settings		
▶ Wired LAN IPV4 Configuration		
<ul style="list-style-type: none"> DHCP Mode 	<p>Select Enabled to configure TCP/IP settings by a Dynamic Host Configuration Protocol (DHCP) server.</p> <p>OR</p> <p>Select Disabled to configure TCP/IP settings manually.</p>	

APPENDIX C
REMOTELY MANAGING YOUR ROOM SYSTEM USING INTEL AMT

Control	Procedure	Notes (if any)
<ul style="list-style-type: none"> IPV4 Address 	Type the IPv4 address for the room system.	This control is only available if you disabled DHCP.
<ul style="list-style-type: none"> Subnet Mask Address 	Type the subnet mask address for the room system.	This control is only available if you disabled DHCP.
<ul style="list-style-type: none"> Default Gateway Address 	Type the default Gateway address for the room system.	This control is only available if you disabled DHCP.
<ul style="list-style-type: none"> Preferred DNS Address 	Type the preferred DNS address for the room system.	This control is only available if you disabled DHCP.
<ul style="list-style-type: none"> Alternate DNS Address 	Type the alternate DNS address for the room system.	This control is only available if you disabled DHCP.
<ul style="list-style-type: none"> Activate Network Access 	Select Y to transition Intel MEBx to the POST provisioning state if all network settings are configured. OR Select N to disable this feature.	You must activate network access to remotely manage your room system using Intel AMT.
<ul style="list-style-type: none"> Unconfigure Network Access 	Select Full Unprovision to fully reset the network configuration. OR Select Partial Unprovision to reset the network configuration except for Pre-Shared Key (PSK) settings, remote configuration settings and network settings.	
▶ Remote Setup And Configuration		
<ul style="list-style-type: none"> Current Provisioning Mode 	View the current provisioning TLS mode: Public Key Infrastructure (PKI), PSK or None.	
<ul style="list-style-type: none"> Provisioning Record 	View the room system's provision PSK/PKI data.	
<ul style="list-style-type: none"> Provisioning Server IPV4/IPV6 	Type the port number of the Intel AMT provisioning server.	The default port is 9971.
<ul style="list-style-type: none"> Provisioning Server FQDN 	Type the FQDN of the provisioning server mentioned in the certificate.	
▶ RCFG		
<ul style="list-style-type: none"> Start Configuration 	Select Y to activate remote configuration. OR Select N to not activate remote configuration.	
▶ TLS PSK		
<ul style="list-style-type: none"> Set PID and PPS 	Type the provisioning ID (PID) and provisioning pre-shared key (PPS) in the dash format.	
<ul style="list-style-type: none"> Start Configuration 	Select Y to delete the PID and PPS. OR Select N to not delete the PID and PPS.	

Control	Procedure	Notes (if any)
▶ TLS PKI		
<ul style="list-style-type: none">Remote Configuration	Select Enabled to enable remote configuration. OR Select Disabled to disable remote configuration.	
<ul style="list-style-type: none">PKI DNS Suffix	Type the PKI DNS suffix.	
<ul style="list-style-type: none">Manage Hashes	Select to manage hashes on the room system.	

References

- *Introducing the Intel vPro Platform Solution Manager*
software.intel.com/en-us/blogs/2013/04/19/introducing-the-intel-vpro-platform-solution-manager
- *Intel AMT start here guide*
software.intel.com/en-us/articles/intel-active-management-technology-start-here-guide-intel-amt-9
- *Intel AMT implementation and reference guide*
software.intel.com/sites/manageability/AMT_Implementation_and_Reference_Guide

Appendix D

Resetting the room system to factory defaults

This appendix explains how to reset the room system to factory defaults.

In most situations, you should reset the room system from the *Settings* screen. However, if the room system is in an unrecoverable state or the *Settings* screen is otherwise not accessible, you can reset the room system from the BIOS.

To reset the room system from the Settings screen

1. On the console, press **Options**, and then press **Settings**.

The *Enter your credentials* screen appears.

2. Type the room system administrator account's user name and password in the text boxes, and then press **Authenticate**.

The room system restarts.

3. Type the room system administrator account's password, and then press ENTER.

The Lync Admin Console appears.

4. Press **Web Updates**.

5. Press **Reset the Device to Factory Image**.

The room system restarts, and the software is reset to factory defaults.

6. Complete the procedure in *Configuring your room system's software* on page 17.

To reset the room system from the BIOS

1. Turn off your room system (see *Turning off your room system* on page 57).
2. Connect a USB keyboard to the Lync appliance.

APPENDIX D
RESETTING THE ROOM SYSTEM TO FACTORY DEFAULTS

3. Turn on the room system by completing the appropriate procedure for the room size:

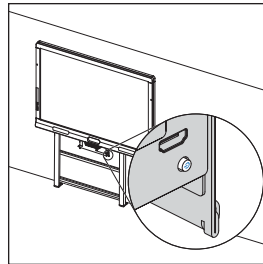
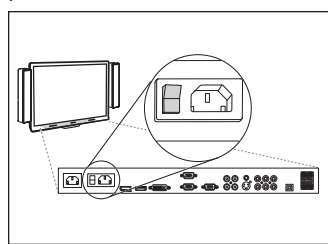
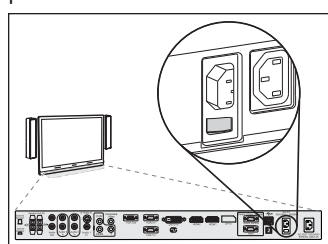
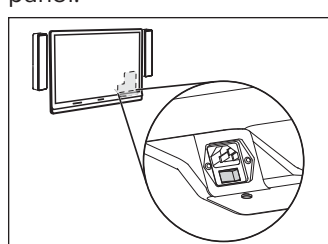
Room size	Procedure
Extra small room	<p data-bbox="673 367 1380 399">a. Press the power button on the Lync appliance enclosure.</p>  <p data-bbox="673 682 1396 745">b. Flick the power switch on the bottom of the interactive flat panel.</p> 
Small room	<p data-bbox="714 1018 1396 1081">Flick the power switch on the bottom of the interactive flat panel.</p> 
Medium room	<p data-bbox="714 1354 1396 1417">Flick the power switch on the bottom of the interactive flat panel.</p> 

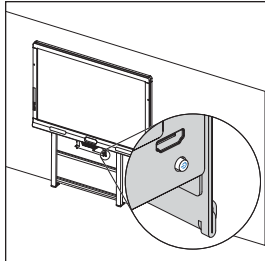
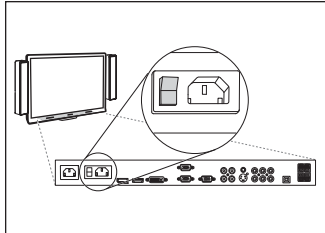
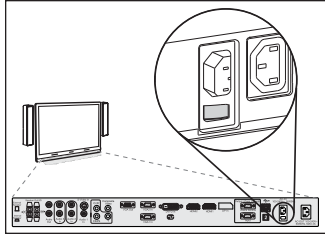
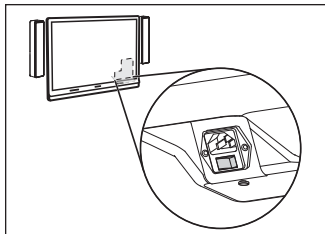
Room size	Procedure
Medium room with dual panels	<p data-bbox="678 310 1380 340">a. Press the power button on the Lync appliance enclosure.</p>  <p data-bbox="678 630 1412 688">b. Flick the power switch on the bottom of both interactive flat panels.</p> 
Large room	<p data-bbox="717 970 1412 1029">Flick the power switch on the bottom of both interactive flat panels.</p> 
Extra large room	<p data-bbox="717 1306 1412 1365">Flick the power switch on the bottom of both interactive flat panels.</p> 

4. Press the DELETE key.
The Lync appliance enters BIOS mode.
5. Browse to the **Advanced** tab.
6. Select **Recovery Function**, and then press ENTER.

APPENDIX D
RESETTING THE ROOM SYSTEM TO FACTORY DEFAULTS

7. Set *Image Recovery* to **Enabled**.
8. Press ESC.
9. Browse to the **Save & Exit** tab.
10. Select **Save Changes and Exit**, and then select **Yes**.

The room system restarts, and the software is reset to factory defaults.

11. Complete the procedure in *Configuring your room system's software* on page 17.

Appendix E

Hardware environmental compliance

SMART Technologies supports global efforts to ensure that electronic equipment is manufactured, sold and disposed of in a safe and environmentally friendly manner.

Waste Electrical and Electronic Equipment and Battery regulations (WEEE and Battery Directives)

Electrical and electronic equipment and batteries contain substances that can be harmful to the environment and to human health. The crossed-out wheeled bin symbol indicates that products should be disposed of in the appropriate recycling stream and not as regular waste.



Batteries

The remote control contains 1.5V AAA batteries. Recycle or dispose of batteries properly.

More information

See smarttech.com/compliance for more information.

Index

A

- accessibility 48
- accessories 6
- ad hoc meetings 39
- Administrative Web Portal See Lync Room
 - System Administrative Web Portal
- administrator accounts 27
- air conditioning 14, 65
- ambient lighting 98, 103
- AMT See Intel AMT
- annotations 44
- audio
 - configuring 92, 103, 110
 - maintaining 68
 - sharing 2
 - troubleshooting 78
- audio processor 5

B

- backlight 108
- backlighting, issues with 14
- batteries 95, 133
- black level 97, 102, 109
- brightness 97, 102, 108
- business hours 30, 91

C

- cable raceways 6
- cable ties 52
- cables
 - using cable strain relief with 68
 - using to isolate hardware issues 52

- calendar
 - testing 35, 80
 - using to join meetings 39
- calibration 30, 59, 91, See also orientation
- calls
 - converting to meetings 40
 - making test 35, 82
- cameras
 - about 5
 - cleaning 67
 - optimizing 32, 92
 - troubleshooting 77
- certificates 88
- chemicals 64
- cleaning
 - cameras 67
 - interactive flat panel cameras and reflective tape channels 64
 - interactive flat panel screens 63
 - microphones 68
 - presence detection sensors 64
 - speakers 68
- collaboration 2
- color temperature 97, 102, 109
- computers See laptops
- condensation 65
- connectors, accessing 66
- consoles
 - about 4
 - cleaning 67
 - configuring 29
 - managing meetings with 40
 - troubleshooting 76
 - viewing information and settings 92
- contrast 97, 102, 108
- countries 27, 89
- credentials See passwords
- Customer Experience Program 33, 87

D

DameWare 122
date and time 28, 89
diagnostic logs 55
dial pad 40, 42
digital ink 44
digital pan, tilt and zoom 5
displays
 consoles See consoles
 interactive flat panels See interactive flat panels
documentation 8
domains 81
doors 14
drawing 44
dry-erase markers 63
dust 14, 64-65, 67
DViT technology 4

E

e-mail 48
event logs 88
Exchange See Microsoft Exchange
extra large rooms 8
extra small rooms 6

F

factory defaults 90, 129
field of view 5
firewall 89
firmware updates 56
flashlights 52

G

gallery of participants 41
gates 14
glass cleaner 63, 67

guest laptops See laptops

H

hardware installation 13, 68
hardware isolation testing 52
hardware removal 69
HDMI 5, 79
health status 54
high contrast themes 49
humidity 65

I

ink 44
installation instructions 9, 13, 68
instant messaging 41
Intel AMT
 about 117
 configuring 120
 enabling 118
 managing your room system with 121
 security 123
Intel MEBx 120
interactive flat panels
 about 4
 configuring 18, 29, 91
 maintaining 59
 troubleshooting 74
 using the on-screen display menu 95
Internet settings 89

K

keyboards
 on-screen 41
 physical 18
keys See product keys
kickstands 66
KMS servers 11, 34
knowledge base 10

L

- ladders 52
- languages 27, 89, 98, 104
- laptops 5, 43, 79, See also room
 - computers
- large meetings 40
- large rooms 7
- licenses See product keys
- lighting 14
- lights 73
- loaction for installing your room system 14
- local building codes 14
- logging 33, 55, 87
- Lync 2010 33, 87
- Lync appliances 4, 17
- Lync infrastructure 2, 11
- Lync Room System Administrative Web
 - Portal 53
- Lync Room System software
 - about 2
 - configuring 33
 - product key for 34
 - troubleshooting 80
 - using 37
- Lync Web Service certificate 81

M

- magnifier See screen magnifier
- MAKs 11, 34
- markers 63
- MEBx See Intel MEBx
- media, enabling in PowerPoint files 44
- medium rooms 7
- meetings
 - converting existing meetings to Lync
 - meetings 38
 - ending 50
 - managing with the console 40
 - presneting content during 42, 48
 - scheduling 37

- starting 39
- microphones
 - about 5
 - cleaning 68
 - connecting additional 6
 - muting 41
 - setting default volume for 54, 87
 - troubleshooting 78
- Microsoft Exchange
 - preparing for your room system 11
 - testing access to 35
- Microsoft Lync appliances See Lync
 - appliances
- Microsoft Lync infrastructure See Lync
 - infrastructure
- Microsoft Lync Room System
 - software See Lync Room System
 - software
- Microsoft Office 365 90
- Microsoft Outlook 37, 52
- Microsoft PowerPoint 2, 44, 81
- Microsoft updates 89
- mouse 18
- mute 41

N

- narrator See screen narrator
- network requirements 11
- nylon cable ties 52

O

- Office 365 See Microsoft Office 365
- on-screen display menu 95
- on-screen keyboard 41
- Open MDTK 121
- orientation 30, 62, 91, See also calibration
- Outlook See Microsoft Outlook

P

- packaging 69

INDEX

- participants, meeting 40
- passwords 27, 33, 54, 86, 90, 120
- pens, replacing nibs for 66
- permanent markers 63
- phone features 40, 42
- ports, Intel AMT 123
- power 14
- power lights 73
- power saving mode 30
- prerequisites 11, 18
- presence detection sensors 92
 - about 3
 - cleaning 64
 - configuring 100, 105
 - troubleshooting 74
 - turning on the room system with 38
- privacy 5
- product keys 34
- proxy authentication 33, 86

Q

- quality control 33, 87

R

- recessed areas 14
- recovery 129
- regions 27, 89
- remote control 95
- remote monitoring and management 53, 117
- ringer 54, 87
- room computers 5, 44, 79, 88, See
 - also laptops
- room systems
 - about 2
 - accessories for 6
 - comparing 6
 - components of 3
 - features of 2
 - installing hardware 13, 68
 - maintaining 51
 - preparing for 11

- resetting 129
- restarting remotely 55
- testing 35, 82
- troubleshooting 71
- turning off 57
- turning on 18, 38
- updating software and firmware for 56
- using 37
- viewing information and health status of 54

- room tags See tags

S

- SCOM 53
- screen magnifier 49
- screen narrator 49
- screens
 - consoles See consoles
 - interactive flat panels See interactive flat panels
- screw drivers 52
- serial numbers 72, 92
- sharpness 97, 102, 108
- shutters, camera 5
- SIP URIs 33, 81
- small rooms 7
- SMART Board interactive flat
 - panels See interactive flat panels
- SMART Room System USB Bridge
 - about 5
 - connecting a guest laptop to 43
 - connecting a room computer to 44
 - installing software for 42
 - orienting touch 46
- SMART Room Systems See room systems
- SMART Settings 30, 91
- SMART updates 89
- smoke 65
- software configuration 17
- software updates 56
- speakers
 - about 5
 - cleaning 68

INDEX

- muting 41
- setting default volume for 54, 87
- troubleshooting 78
- special needs 48
- specifications 9
- startup 2, 39
- status lights 73
- strain relief, cable 68
- sunlight 65
- support
 - Microsoft 80
 - SMART 10

T

- tags 54
- tape measures 52
- test calls 35, 82, 87
- themes 49
- time See date and time
- time zones 28
- tint 97, 102, 109
- TLS 123
- tools, recommended 52
- touch panels See interactive flat panels
- training 10
- transportation 69
- troubleshooting 71
- trusted domains 81
- tutorial 10, 88

U

- updates 89
- USB Bridge See SMART Room System
 - USB Bridge
- user names 27, 33, 86

V

- vacuum cleaners 65
- ventilation 14, 65
- VGA 5, 79

- vibration 14, 69
- video connection harness 5
- videos 2, 41, See also cameras
- VNC Viewer Plus 122
- volume 36, 41, 78, 87

W

- wall stand kits 6
- water 64
- Web Portal See Lync Room System
 - Administrative Web Portal
- Web Service certificate 81
- web updates 89
- WEEE and Battery Directives 133
- whiteboard feature 2, 48
- Windows Firewall 89
- Windows Server Update Services server 89
- writing 44

SMART TECHNOLOGIES

smarttech.com/support

smarttech.com/contactsupport

smarttech.com/kb/170450