



WASHING MACHINE INSTRUCTION MANUAL



Model number:

RHM51000B

Please read these instructions carefully and keep them for future reference

For Customer Services, Spare Parts & Warranty Information please call

0845 683 8717

Opening times:

Monday - Friday 8am until 8pm

Saturday & Sunday 10am until 4pm

Contents

Before use

- Components 03
- Preparation 04
- Safety instructions 05
- Installation 06
- Control panel 08

Using the Appliance

- Program selection10
- Consumption and technical data...11
- Washing methods 12

Maintenance

- Cleaning & Care16
- Display codes 18
- Trouble Shooting.....19

For your safety, all warning instructions in this manual should be followed.

Before use

Components

Please read these instructions carefully before using this appliance. The instructions contain important information which will help you get the most out of the appliance and ensure safe and proper installation, use and maintenance.

Keep this manual in a convenient place so you can always refer to it for the safe and proper use of the appliance.

If you sell the appliance, give it away, or leave it behind when you move house, make sure you also pass on this manual so that the new owner can become familiar with the appliance and safety warnings

Accessories

Check the box contents using the list below

1x Inlet hose assembly



1x Bottom Cover



1x User manual



1x Drain hose bracket



3x Blanking plugs



For Customer Services, Spare Parts & Warranty Information please call **0845 683 8717**

Before use

Preparation

Remove all the packing materials to prevent unsteadiness, including the polystyrene base. When opening the packaging, water drops may be seen on the plastic bag and the porthole. This is normal and is the result of water tests in the factory.

Description

This diagram may be slightly different from the layout of the washing machine you have just purchased due to technical improvements.

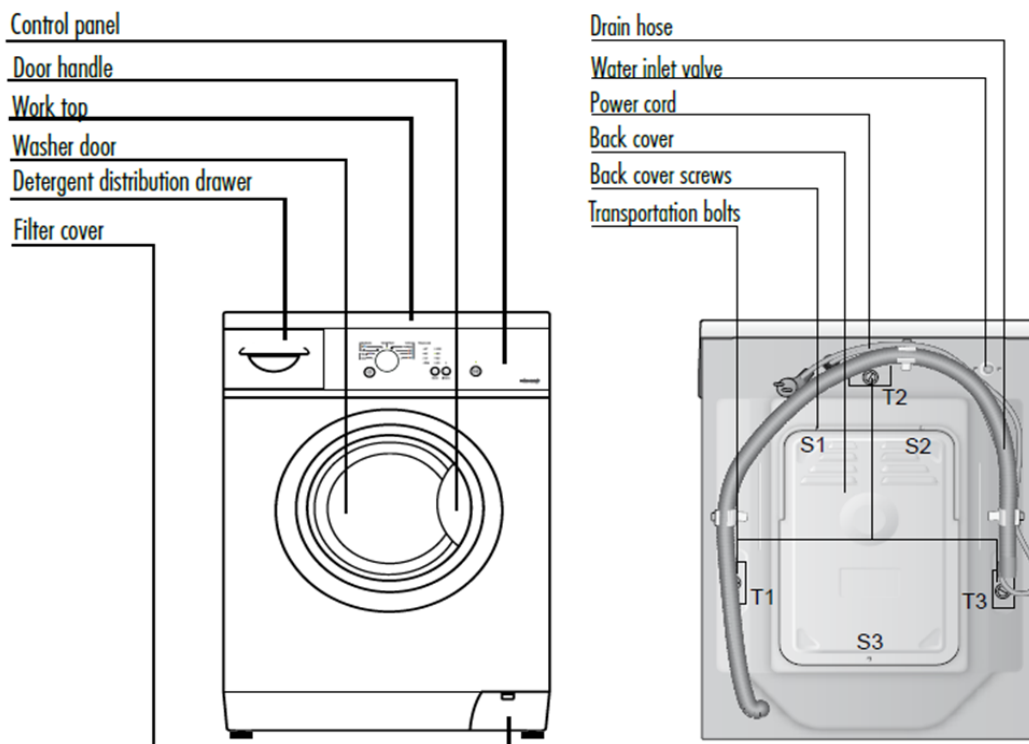
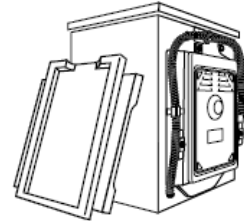

For Customer Services, Spare Parts & Warranty Information please call **0845 683 8717**

Safety Instructions

Before switching the appliance on for the first time ensure the following precautions are taken:

- Do not use multiple receptacles or extension cord
- Do not plug in damaged or torn plugs
- Make sure that the transport bolts are removed.
- Make sure that the transport bolts are removed.
- Use a separate earthed socket for the power supply.
- Make sure that the plug is accessible and not obstructed by the washing machine.
- Hold the plug and not the electric cable when unplugging the power supply.
- Make sure that the fuses in the power circuit are rated for 15a.
- Keep away from heat sources and direct sun light to prevent plastic and rubber components from aging.
- Make sure that the power cord is not caught under or in the appliance and avoid damage to the power cable.
- Check that hose joints and connections are firm and no water can leak. If joints are loose or there is leakage, turn off the water supply and repair. Do not use the washing machine until the hoses are properly fixed.
- When using, pull up zips and fix loose threads to prevent the items from being entangled. If necessary, put small items into a net bag or pillow.
- Turn off the machine after each wash program and switch it off at the mains to save electricity and for safety. Wipe clean the lower part of the porthole.
- Keep the door slightly open when the washing machine is not in use to prevent formation of odours.
- The power cord should only be replaced by the manufacturer; their service agent or other accordingly qualified persons, in case it is damaged.
- Ensure that the appliance is only used by persons with sufficient capabilities, experience and knowledge.
- Supervise children to ensure that they do not play with the appliance.

Ensure that you DO NOT:

- Touch or use the appliance when barefooted or with wet or damp hands or feet.
- Use flammable detergent or dry cleaning agent.
- Use any flammable sprays in close vicinity to the appliance.
- Remove or insert the plug in the presence of flammable gas.
- Allow children or infirm persons to play with the appliance or packing materials.
- Install the appliance outdoors in a damp place, or in an area which may be prone to water leaks such as under or near a sink unit. In the event of a water leak allow the machine to dry naturally.
- Place the washing machine directly on a carpet, or close to a wall or furniture.
- Cover the washing machine with a plastic cover as this will restrict airflow into the machine.
- Touch the washer door during the washing process as this can get hot and may result in injury.
- Place heavy objects or sources of heat or damp on top of the appliance.
- Hot wash foam rubber or sponge-like materials.
- Open the detergent distribution drawer during the wash cycle.
- Force the washer door open. The door is fitted with a self-lock device and will open shortly after the washing procedure is ended.
- Open the washer door if the water level is visibly over the porthole

For Customer Services, Spare Parts & Warranty Information please call **0845 683 8717**

Installation

Adjusting the bottom cover

When opening the shrink package, you will find a calcium plastic board which is laid on the top of washing machine as shown in fig.1. The board is used for reducing noise by passing it under the cabinet when setting as shown in fig.2.

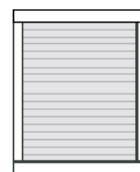

Fig.1

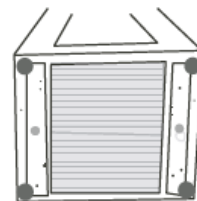
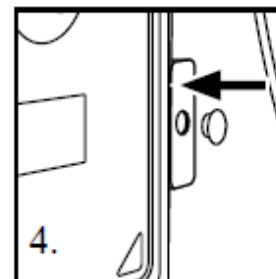
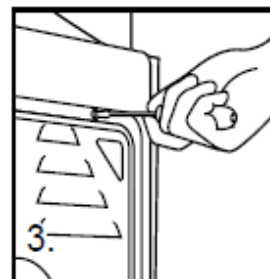
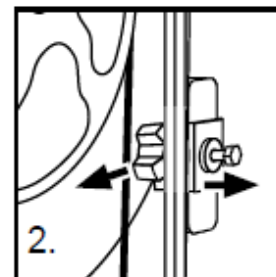
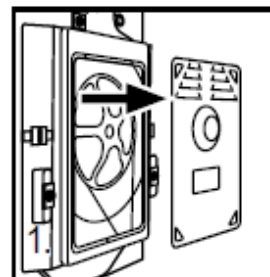

Fig.2

Dismantle the transportation bolts

The transportation bolts are designed for clamping anti-vibration components inside of the washing machine during the transportation process and try to ensure the unit is protected during transportation.

1. Remove the back cover by removing the 3 screws holding it in place.
2. Remove the three bolts on the rear side and take out the synthetic stabilisers from within the machine.
3. Replace the back cover (please note that you may have to hold the back cover in place by holding the vents on the back cover).
4. Fill the holes left by the bolts with blanking plugs.



Note:

1. When replacing the back cover, ensure it is positioned in the same way that it was originally removed.
2. Keep the transportation bolts and synthetic stabilisers in a safe place for later use.

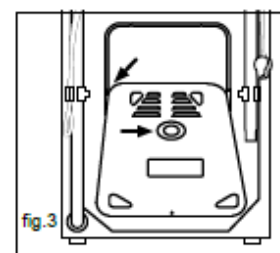

Adjusting the height of the washing machine

There are adjustable feet attached to the bottom of the washing machine. Before use, they should be adjusted so that the machine is level - this will minimise vibrations and noise during use, as well as reducing wear and tear.

We recommend using a spirit level to level the appliance - the floor that the washing machine is put on should be as stable and flat as possible.

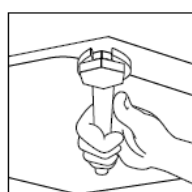

Installation Continued

Inlet hose

1. Connect the inlet hose to the connector on the water valve.
2. Apply inlet hose to a water tap with cold, fresh water.

Note: Use the hose-set supplied with the appliance - old hose-sets should not be reused.

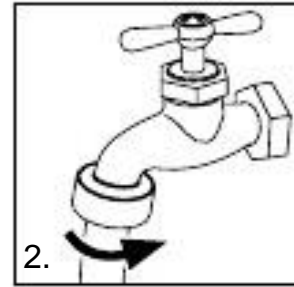
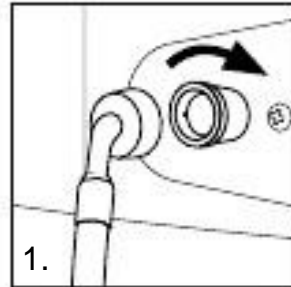

Drain Hose

1. Use the drain hose bracket to keep the end of the drain hose retained and prevent the outflow of water. Do not extend the length of the drain hose; if an extended hose is required, please consult an approved technician.
2. The height of the drainage outlet must be 80-100 cm. Fix the drain hose to the clip at the back of the washing machine to prevent it from dropping off.

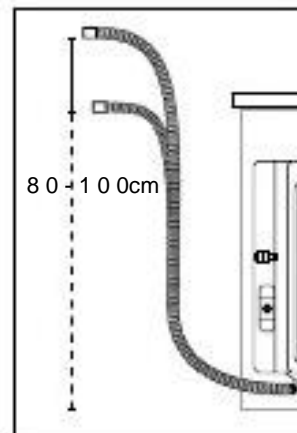
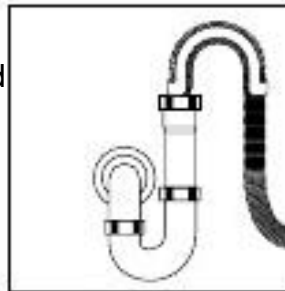

Note: the drain hose should not be submerged in water and should be securely fixed and leak-free. If the drain hose is placed on the ground or if the pipe is at a height of less than 80cm, the washing machine will continuously drain while being filled (self-siphoning).

Connecting to the power supply

Before connecting to the power supply, check:

- The socket is adequate for the maximum power of the washing machine
- For safety, fuses in the power circuit should be rated for no less than 15a.
- The voltage should meet the requirement.
- The power outlet should be capable of accepting the washing machine plug.
- Connect the machine to an earthed socket outlet.

For Customer Services, Spare Parts & Warranty Information please call **0845 683 8717**

Control Panel

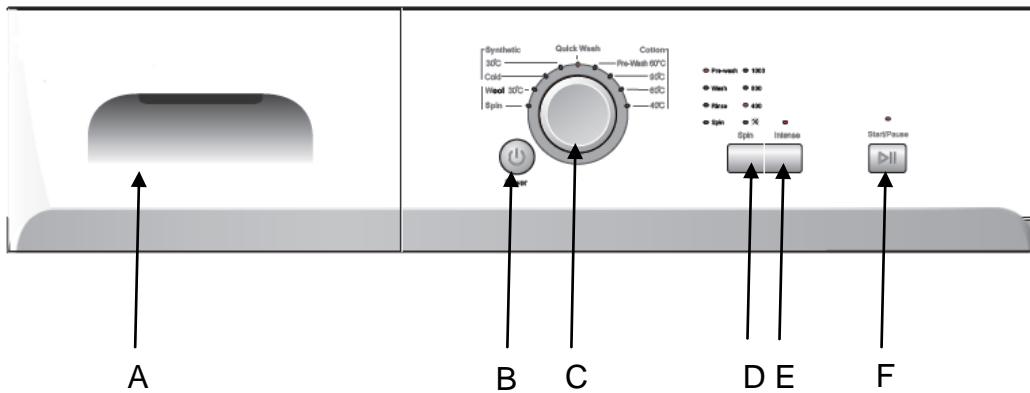

- | | | | |
|---|------------------|---|-------------------------------|
| A | Detergent drawer | D | Spinning Speed Setting Button |
| B | Power Button | E | Intense button |
| C | Program knob | F | Start/Pause Button |

Programs

- | | | |
|---|--------------------|--|
| A | - Detergent drawer | The drawer contains three compartments:
1: Main wash detergent
2: Fabric softener
3: Prewash detergent |
| B | - Power button | Press this button to switch on the washing machine. Press and hold for 2 seconds to switch the machine off. |
| C | - Program knob | By turning the knob clockwise/anti-clockwise, the required program can be selected.

There are 9 programs available. After a program is selected, the corresponding light will be illuminated. |

For Customer Services, Spare Parts & Warranty Information please call **0845 683 8717**

Control Panel Continued

- D - Spinning speed setting button
Touch this button lightly to select the desired speed. When a speed is set, the indicator light will be light on.
- E - Intense button
Touch this button lightly, the indicator light will be on. You can increase the washing time, rinsing times in main wash stage of the selected program, which is suitable for dirty clothes.
- F - Start/Pause button
When the washing machine is connected to the power socket and a program is selected, lightly touch this button to start operation. During a wash cycle, touch it lightly, the machine will stop and the indicator light will start blinking. Touch it again to resume operation.
- To cancel a wash program during a wash cycle, touch this button, when the indicator light starts blinking, press the Power switch once, the program will be cancelled.

Program Selection

Program		Temperature	Recommended laundry	Spin speed	
1	Cotton	Prewash	60°C	Very heavy soiling	1000 rpm
2		90°C	90°C	Heavy soiling	1000 rpm
3		60 °C	60°C	Soiled cotton	1000 rpm
4		40 °C	40°C	Non-fade and medium soiled	1000 rpm
5		Quick	40°C	Medium soiled laundry	1000 rpm
6	Synthetic	30 °C	30°C	Colour fast heavily soiled synthetic fibre	1000 rpm
7		Cold	/	Fade and medium soiled synthetic fibre	1000 rpm
8		Wool 30 °C	30°C	Non colour fast and medium soiled synthetic fibre	600 rpm
9		Spin	/		1000 rpm

Consumption and Technical Data

Consumption table

The wash cycle times are intended as a guide only. The actual time used may vary due to different water pressure, initial water temperature, etc.

Program		Max. Load	Energy Consumption	Water Consumption	Temperature	Washing time
Cotton	- Prewash	5 kg	1.16kWh	52L	60°C	2:16 h
	- 90°C	5 kg	1.56kWh	46L	90°C	2:08 h
	- 60 °C*	5 kg	0.95kWh	49L	60°C	2:59 h
	- 60 °	5 kg	1.14kWh	45L	60°C	1:59 h
	- 40 °C	5 kg	0.43kWh	45L	40°C	1:47 h
	- Quick	2.5 kg	0.31kWh	30L	40°C	0:29 h
Synthetic	- 30 °C	3 kg	0.34kWh	32L	30°C	1:10 h
	- Cold	3 kg	0.10kWh	32L	/	1:00 h
	- Wool 40 °C	2 kg	0.41kWh	31L	40°C	0:50 h
	- Spin	5 kg	/	/	/	0:12 h

* EN 60456 test program / Energy label program with cotton 60°C , max. spin speed and intense function.

Technical data

RHWM51000B

Power source	220 - 240V~/50Hz	
Max. working current (a)	10	
Water pressure (MPa)	0.03≤P ≤1	
Nominal load (kg)	5	
Spinning speed (r/min)	1000	
Washing programs	9	
Max power (W)	2000	
Dims (H x D x W mm)	850 x 520 x 595	
Net weight (kg)	65	

For Customer Services, Spare Parts & Warranty Information please call **0845 683 8717**

Washing methods

Please Note

This washing machine is for domestic use only. If the machine is used for commercial purposes the guarantee will be rendered void. Do not use it for purposes other than that for which it was designed. Follow the instructions given on the label of each garment and wash only machine-washable garments.



Power supply

Connect the washing machine to the power supply (220V to 240V~/50Hz).

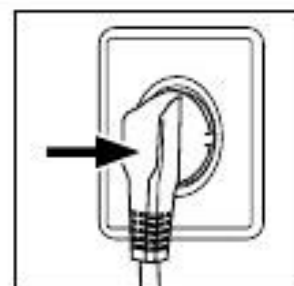

Water connection

Turn on the tap. Only use cold, clean water.

Note: Before use, check for leakage in the joints between the tap and the inlet hose by turning on the tap.



Preparing the laundry

- Separate clothes according to fabric (cotton, synthetics, wool or silk) and to how dirty they are.
- Always wash white clothes and coloured clothes separately.
- Empty pockets and remove all decorative objects (eg. badges)
- Attention: Small parts (buttons, etc) may lead to repair work which is not covered under warranty.
- Garments without hems, underwear, finely woven textile such as fine curtains should be put in a wash bag (ideally these garments should be hand washed).
- Close zippers and hooks, make sure the buttons are sewn on tightly and place small items such as socks, belts, bras, etc. in a wash bag.
- Unfold large pieces of fabric such as bed sheets, bedspreads, etc.
- Turn shirts inside out.

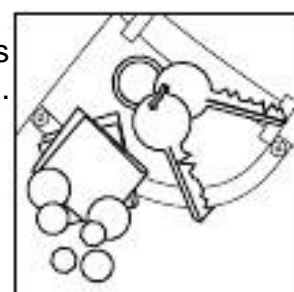
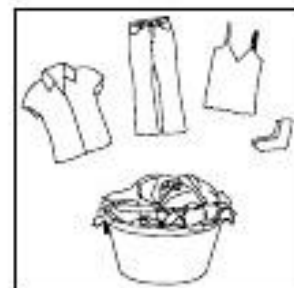

Using the machine

Loading the machine

- Open the washer door and put in the laundry piece by piece. Close the door tightly.
- When first using the washing machine, let it run unloaded for one program to ensure the inside of the machine is clean.
- Before washing you should run the machine without laundry and with detergent, with 60°C program.
- Do not overload the washing machine.

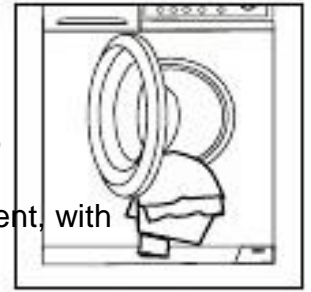

Selecting detergent

The washing efficiency and the performance is determined by the quality of detergent used. Special non-foaming detergent produces good washing results. Use specific detergents for synthetic and woollen goods. Do not use dry cleaning agents such as trichloroethylene and similar products.

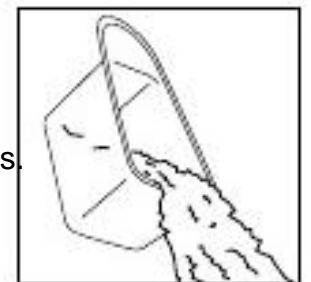

Note: do not add more detergent than needed. Always use quantities of washing powder as recommended by the washing powder manufacturer.

Adding detergent

Slide out the detergent drawer and put the required detergent and softening agent into the corresponding compartments. Push back the drawer gently (refer to the instructions on the drawer).

Caution:

- For prewashing program, detergent should be added to both compartments 1 and 2. For other programs, do not add detergent to compartment 1.
- Use liquid detergent according to the instructions on its package. Do not use liquid detergent in the prewash mode .
- Do not use too much softener; this may damage the artificial fibres.

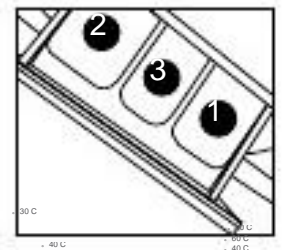

Selecting a program

To get the best washing results, an appropriate washing program should be selected according to the laundry type. Turn the program knob to select the right program.

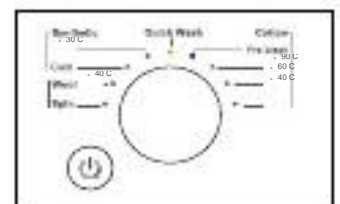

Selecting functional

Select the required options. (refer to the "Control panel" pages 8 and 9)

Using the machine continued

Setting spin speed

Touch this button lightly to select the desired speed. When a speed is set, the indicator light will be light on.

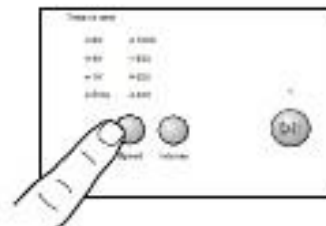

Intensity button

Touch this button lightly; the indicator light will be light on. You can increase the washing time and rinsing times in the main wash stage of the selected program, which is suitable for the laundry you are washing

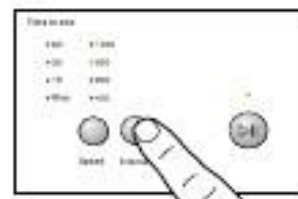

Start washing

When the washing machine is connected to the power socket and a program is selected, lightly touch the start button to begin operation. During a wash cycle, touch again lightly and the machine will stop. The indicator light start flashing. Touch again to resume operation. To cancel a wash program during a wash cycle, touch this button, when the indicator light starts flashing, press the power switch, the program will be cancelled.

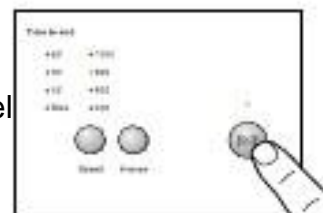

After washing

Turn off the water supply and unplug the power cord. Open the washer door to prevent formation of moisture and odours. Leave the door open when not in use.

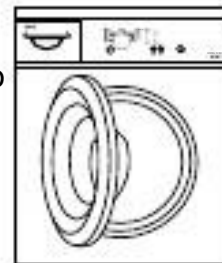























Tips for saving energy

1. Always wash a full load.
2. Avoid overloading the washing machine.
3. Prewash only heavily soiled clothes.
4. Reduce the amount of detergent or choose standard or delicate wash programs for slightly soiled clothes.
5. Choose the correct washing temperature. Modern detergents can wash with very good result in lower temperatures. Only use higher temperature for heavily soiled laundry.
6. Follow the usage recommendation on the detergent package to avoid using too much detergent.

Using the machine continued

Care chart

	Resistant material		Bleachable in cold water		Do not dry clean
	Delicate fabric		Do not bleach		Dry flat
	Wash at 95 °C		Iron at 200 °C		Hang dry
	Wash at 60 °C		Iron at 150 °C		Dry on clothes hanger
	Wash at 40 °C		Iron at 100 °C		Tumble dry, normal heat
	Wash at 30 °C		Do not iron		Tumble dry, reduced heat
	Hand wash				Do not tumble dry
	Dry clean only				
	Wool Seal				

Load reference

Bed sheet (single)	Cotton	Approximately 800g
Blanket	Wool	Approximately 3000g
Blended fabric clothes	/	Approximately 800g
Jackets	Cotton	Approximately 800g
Jeans	/	Approximately 800g
Overalls	Cotton	Approximately 950g
ladies Pyjamas	/	Approximately 200g
Shirts	/	Approximately 300g
Socks	Blended fabrics	Approximately 50g
T-Shirts	Cotton	Approximately 300g
Underwear	Blended fabrics	Approximately 70g

For Customer Services, Spare Parts & Warranty Information please call **0845 683 8717**

Cleaning and Care

After washing

Turn off the water supply and pull out electricity plug after each wash. Open the washer door to prevent formation of moisture and odours. If the washing machine is left idle for a long period, drain the water in the machine and replace the drain hose.

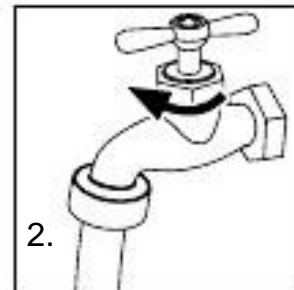
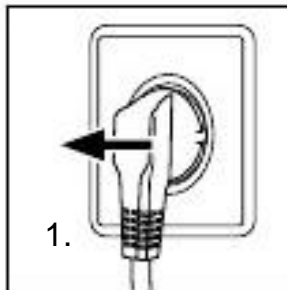

Cleaning the detergent drawer

Clean the detergent distribution drawer regularly. Pull out the drawer, clean with water and then replace it.



Cleaning the machine

Unplug the machine during cleaning and maintenance. Use a soft cloth dampened with soap liquid to clean the machine case and rubber components. Do not use organic chemicals or corrosive solvents.

Cleaning the filter

Clean the filter once a month:

1. Open the bottom cover.
2. Remove the filter by turning anti-clockwise.
3. Rinse the filter clean with running water.
4. Replace the filter by turning clockwise and replace the cover.

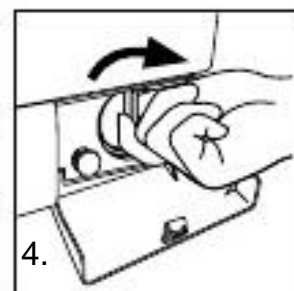
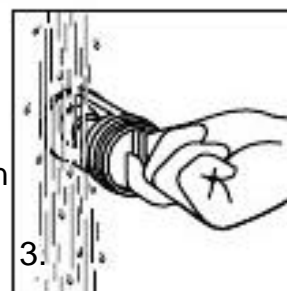
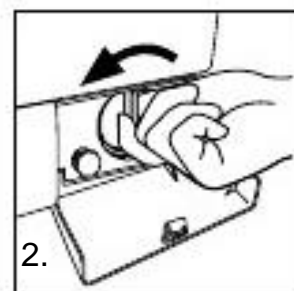
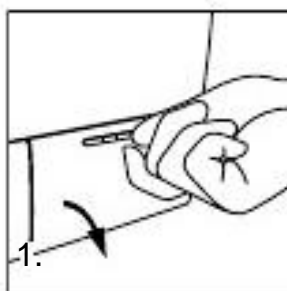

Caution:

1. The filter must be in place, or it may lead to leakage.
2. Place a container under the drain pump filter, to collect any excess water that may come out of the drain pump when the filter is removed.

Cleaning and Care Continued

Water inlet valve and inlet valve filter

To prevent blockage to the water supply from foreign objects, ensure the water inlet valve and inlet valve filter are cleaned regularly.

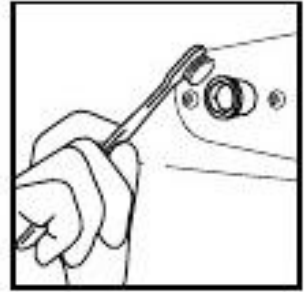

Moving the machine

If the machine needs to be moved, replace the transportation bolts removed before installation to prevent damage as shown below.

1. Remove the blanking plugs.
2. Remove the back cover
3. Insert the synthetic stabilisers and the transportation bolts.
4. Tighten the bolts with a spanner. replace the back cover.

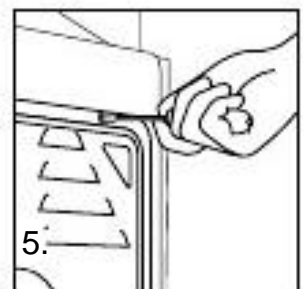
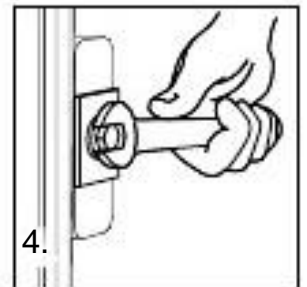
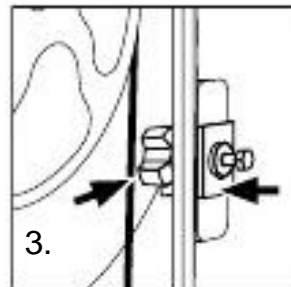
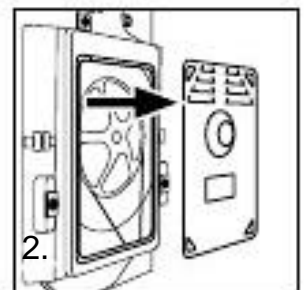
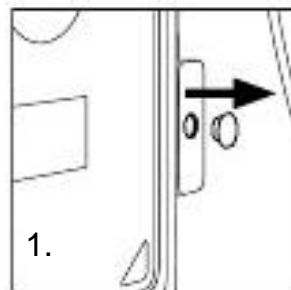

Long periods of disuse

If the washing machine is left idle for a long period, pull out the electrical plug and turn off the water supply. Open the washer door to prevent formation of moisture and odours. Leave the door open while not in use.

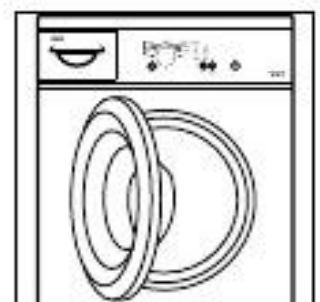

Cleaning and Care Continued

Display codes and special functions

Problem	Causes	Solution
Err1: The start indicator wasn't light and the buzzer sound abnormally.	- door is not properly shut.	- Shut the door properly.
Err2: The start indicator flashes on for 0.2s and off 0.2s for twice, repeat 4s later	- drainage error, water not emptied within 4 minutes.	- Clean the filter and check the drain hose for blockage. If error still exists, please contact the maintenance personnel.
Err3: The start indicator lighted on 0.2s and off 0.2s for 3 times, repeat 4s later	- Temperature sensor not properly connected or damaged.	- Contact the maintenance personnel.
Err4: The start indicator lighted on 0.2s and off 0.2s for 4 times, repeat 4s later	- Heater error (appears at the end of a cycle).	- reduce load and then start washing again. If problem still exists, please contact the maintenance personnel.
Err5: The start indicator lighted on 0.2s and off 0.2s for 5 times, repeat 4s later	- Water level not met in 8 minutes. - The height of the drain Hose is below 80 cm. - The drain hose is in water.	- Make sure that tap is turned on, and water pressure is normal. If problem still exists, please contact the maintenance personnel. - Install drain hose within 80-100 cm of height. - Make sure the drain hose is not in water.
Err7: The start indicator lighted on 0.2s and off 0.2s for 7 times, repeat 4s later.	- Motor overheat protection or damage.	- Contact the maintenance personnel.
Err8: The start indicator lighted on 0.2s and off 0.2s for 8 times, repeat 4s later	- Water exceeds protective level.	- Contact the maintenance personnel.

- Foam test function: If the washing machine produces too much foam, the light next to "time to end" will flash for 15 minutes, then the washing cycle will continue. Press "start/pause" to cancel this function.

- Power-off memory function: In case of abrupt power failure or the need to cut off the power during a program cycle, the present settings will be saved and the preset operation will resume when the power is on again.

- To cancel a program press the "Start/Pause" button, then press the power button. The program is automatically cancelled. To select a new program, press the power button again to switch the machine on and turn the program selector to select a program.

For Customer Services, Spare Parts & Warranty Information please call **0845 683 8717**

Maintenance

Problem	Cause	Solution
Washing machine fails to operate.	<ul style="list-style-type: none"> → Poor connection to the power supply. → Power failure. → The washer door is not properly closed. → Machine has not been switched on. 	<ul style="list-style-type: none"> _ Check connection to the power supply. _ Check the power supply. _ Close the washer door properly. _ Make sure the machine is switched on.
Washing machine cannot be filled with water.	<ul style="list-style-type: none"> → The "Start/Pause" button is not pressed. → Water tap is not turned on. → Water pressure is less than 0,03 MPa. → The inlet hose is kinked. → Water supply failure. → The program knob is not properly set. → The washer door is not properly closed. → The inlet hose filter is blocked. 	<ul style="list-style-type: none"> _ press the "Start/Pause" button. _ Turn on the water tap. _ Check water pressure. _ Check the inlet hose. _ Ensure the water supply. _ Set the program knob properly. _ Close the washer door properly. _ Unblock the inlet hose filter.
Machine is draining while being filled.	<ul style="list-style-type: none"> → The height of the drain hose is below 80 cm. → The drain hose is in water. 	<ul style="list-style-type: none"> _ Install drain hose within 80-100 cm of height. _ Make sure the drain hose is not in water.
Drainage failure.	<ul style="list-style-type: none"> → Drain hose is blocked. → Drain hose end is higher than 100 cm above the floor level. → The filter is blocked. 	<ul style="list-style-type: none"> _ Unblock the drain hose. _ Make sure the drain hose end is lower than 100 cm above floor level. _ Unblock the filter.
Strong vibration while spinning.	<ul style="list-style-type: none"> → Not all transportation bolts have been removed. → Washing machine is located on an uneven surface or is not level. → Machine load is over 5 kg. 	<ul style="list-style-type: none"> _ Remove all transportation bolts. _ Make sure the washing machine is on an even surface and levelled. _ Reduce amount of laundry in the drum.
Operation stops before completing wash cycle.	<ul style="list-style-type: none"> → Water or electricity failure. 	<ul style="list-style-type: none"> _ Check the power supply.
Operation stops for a period of time.	<ul style="list-style-type: none"> → Washing machine gives an error message. 	<ul style="list-style-type: none"> _ Check display codes.
Excessive foam in the drum, which is spilled to the distribution drawer.	<ul style="list-style-type: none"> → The detergent is not a low-foaming type or for manual wash. → Excessive use of detergent. 	<ul style="list-style-type: none"> _ Check if your detergent is appropriate. _ Reduce amount of detergent in the distribution drawer.
Automatic adjustment of the washing time.	<ul style="list-style-type: none"> → The washing program duration will be adjusted according to the initial water temperature. 	<ul style="list-style-type: none"> _ This is normal and doesn't affect the functionality.

For Customer Services, Spare Parts &
Warranty Information please call

0845 683 8717

Opening times:

Monday - Friday 8am until 8pm

Saturday & Sunday 10am until 4pm

Alternatively please write to:

Customer Service Department

Picktree Court

Picktree Lane

Chester-le-Street

Co Durham

DH3 3SY



This symbol is known as the 'Crossed-out wheeie bin Symbol'. When this symbol is marked on a product/batteries, it means that the product/batteries should not be disposed of with your general household waste. Only discard electrical/electronic/battery items in separate collection schemes, which cater for the recovery and recycling of materials contained within. Your co-operation is vital to make sure the success of these schemes and for the protection of the environment. For your nearest disposal facility, visit www.recycle-more.co.uk or ask in store for details.

We reserve the right due to possible changes to design to alter the instruction manual without prior notice.