

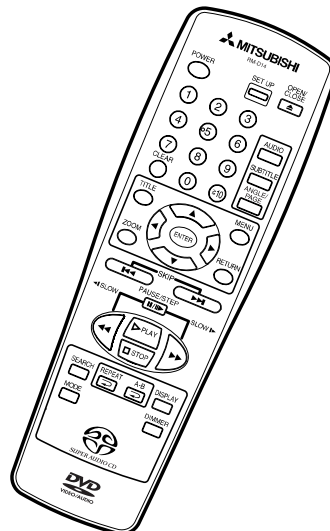

DVD Player Owner's Guide

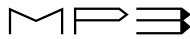

	CAUTION RISK OF ELECTRIC SHOCK DO NOT OPEN	
WARNING: TO REDUCE THE RISK OF ELECTRIC SHOCK, DO NOT REMOVE COVER (OR BACK). NO USER-SERVICEABLE PARTS INSIDE. REFER SERVICING TO QUALIFIED SERVICE PERSONNEL.		

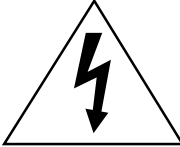

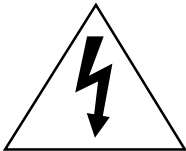
The lightning flash with arrowhead symbol, within an equilateral triangle, is intended to alert the user to the presence of uninsulated “dangerous voltage” within the product’s enclosure that may be of sufficient magnitude to constitute a risk of electric shock to persons.



The exclamation point within an equilateral triangle is intended to alert the user to the presence of important operating and maintenance (servicing) instructions in the literature accompanying the appliance.

WARNING:

TO PREVENT FIRE OR SHOCK HAZARD, DO NOT EXPOSE THIS APPLIANCE TO RAIN OR MOISTURE.

- For models having a power cord with a polarized plug.

CAUTION:

TO PREVENT ELECTRIC SHOCK, MATCH THE WIDE BLADE OF THE PLUG TO THE WIDE SLOT, FULLY INSERT.

ATTENTION:

POUR ÉVITER LES CHOC ÉLECTRIQUES, INTRODUIRE LA LAME LA PLUS LARGE DE LA FICHE DANS LA BORNE CORRESPONDANTE DE LA PRISE ET POUSSER JUSQU’AU FOND.

ANGER:

VISIBLE AND INVISIBLE LASER RADIATION WHEN OPEN AND INTERLOCK DEFEATED
DO NOT STARE INTO BEAM.

CAUTION:

THIS PRODUCT UTILIZES A LASER. USE OF CONTROLS OR ADJUSTMENTS OR PERFORMANCE OF PROCEDURES OTHER THAN THOSE SPECIFIED HEREIN MAY RESULT IN HAZARDOUS RADIATION EXPOSURE.

IMPORTANT SAFEGUARDS

PLEASE READ ALL THESE INSTRUCTIONS AND RETAIN FOR FUTURE REFERENCE. FOLLOW ALL WARNINGS AND INSTRUCTIONS MARKED ON THE DVD PLAYER.

1. Importance of Instructions

All the safety and operating instructions should be read before the appliance is operated. The safety and operating instructions should be retained for future reference.

All warnings on the appliance and in the operating instructions should be adhered to. All instructions should be followed.

2. Cleaning

Unplug this DVD Player from the wall outlet before cleaning. Do not use liquid or aerosol cleaners. Use a damp cloth for cleaning.

3. Attachment and Equipment

Never add any attachments and/or equipment without approval of the manufacturer, as such additions may result in the risk of fire, electric shock, or other personal injury.

4. Water and Moisture

Do not use this DVD Player where contact with or immersion in water is a possibility. Do not use near bath tubs, wash bowls, kitchen sinks, laundry tubs, swimming pools, etc.

5. Moisture Condensation

A drastic change in temperature, such as, moving your DVD player from a cold area to a warm area can cause moisture condensation on the optical pick-up lens. You must allow the player to evaporate any moisture before you play any discs. To do this, remove any discs that are in the player. Then turn the player on for two to three hours until it warms up. Using your DVD player before the moisture evaporates could seriously damage discs and internal parts.

6. Accessories

Do not place this DVD Player on an unstable cart, stand, tripod, bracket, or table. The DVD Player may fall, causing serious injury to a child or adult, and serious damage to the appliance. Use only with a cart, stand, tripod bracket, or table recommended by the manufacturer or sold with the DVD Player. Any mounting of the appliance should follow the manufacturer's instructions, and should use a mounting accessory recommended by the manufacturer.



S3125A

An appliance and cart combination should be moved with care. Quick stops, excessive force, and uneven surfaces may cause the appliance and cart combination to overturn.

7. Ventilation

Slots and openings in the cabinet are provided for ventilation and to ensure reliable operation of the DVD Player and to protect it from overheating. Do not block these openings or allow them to be blocked by placing the DVD Player on a bed, sofa, rug, or other similar surface, nor should it be placed over a radiator or heat register. If the DVD Player is to be placed in a rack or bookcase, ensure that there is adequate ventilation and that you adhere to the manufacturer's instructions.

8. Stacking

Do not place any heavy object(s) on top of your DVD player. The object(s) may fall, causing serious injury and/or damage to the product.

9. Power Sources

This DVD Player should be operated only from the type of power source indicated on the marking label. If you are not sure of the type of power supply to your home, consult your appliance dealer or local power company. Overloading wall outlets and extension cords, can result in a risk of fire or electric shock.

10. Grounding or Polarization

For your safety, this DVD Player is equipped with a polarized alternating current line plug having one blade wider than the other. This plug will fit into the power outlet only one way. If you are unable to insert the plug fully into the outlet, try reversing the plug. If the plug should still fail to fit, contact your electrician to replace your obsolete outlet. Do not defeat the safety purpose of the polarized plug.

11. Power-Cord Protection

Place the power-supply cord out of the way, where it will not be walked on, paying particular attention to cords at plugs, convenience receptacles, and the point where they exit from the appliance.

12. Lightning

Unplug your DVD Player from the wall outlet if it will not be used for a long time or if there is a lightning storm. This will prevent damage to the product due to lightning and power-line surges.

IMPORTANT SAFEGUARDS (continued)

- 13. Object and Liquid Entry**
Never push objects of any kind into this DVD Player through openings, as they may touch dangerous voltage points or short-out parts that could result in a fire or electric shock. Never spill any liquid on the DVD Player.
- 14. Servicing**
Do not attempt to service this DVD Player yourself, as opening or removing covers may expose you to dangerous voltage or other hazards. Refer all servicing to qualified service personnel.
- 15. Damage Requiring Service**
Unplug this DVD Player from the wall outlet and refer servicing to qualified service personnel under the following conditions:
- (a) When the power-supply cord or plug is damaged.
 - (b) If liquid has been spilled, or objects have fallen into the DVD Player.
 - (c) If the DVD Player has been exposed to rain or water.
 - (d) If the DVD Player does not operate normally when you follow the operating instructions. Improper adjustment of other controls may result in damage and will often require extensive work by a qualified technician to restore the DVD Player to its normal operation.
 - (e) If the DVD Player has been dropped or the cabinet has been damaged.
 - (f) When the DVD Player exhibits a distinct change in performance.
- 16. Replacement Parts**
When replacement parts are required, be sure the service technician has used replacement parts specified by the manufacturer, or having the same characteristics as the original part. Unauthorized substitutions may result in fire, electric shock, or other hazards.
- 17. Safety Check**
Upon completion of any service or repairs to this DVD Player, ask the service technician to perform safety checks to determine that the DVD Player is in a safe operating condition.
- 18. Heat**
The DVD Player should be situated away from heat sources, such as radiators, heat registers, stoves, or other products (including amplifiers) that produce heat.
- 19. Radiation Safety**
The laser is covered by a housing which prevents exposure during operation or maintenance. This product is classified as a Laser Product by CDRH (Center for Devices and Radiological Health), a department of the Food and Drug Administration. According to their regulations, 21 CFR section 1002.30, all manufacturers who sell Laser Products must maintain records of written communications among the manufacturer, dealers, and customers concerning radiation safety. If you have any complaints about instructions or explanations affecting the use of this product, please write to us at the address on the back page of this manual. When writing, include the model number and serial number of your DVD Player.
- 20.** In compliance with Federal Regulations, the certification, identification, and period of manufacture are indicated on the rear panel.
- 21. FCC INFORMATION FOR USER**
- CAUTION:**
Changes or modifications not expressly approved by the manufacturer for compliance could void the user's authority to operate the equipment.
- IMPORTANT:**
This equipment has been tested and found to comply with the limits for a Class B digital device, pursuant to Part 15 of the FCC Rules. These limits are designed to provide reasonable protection against harmful interference in a residential installation. This equipment generates, uses, and can radiate radio frequency energy and, if not installed and used in accordance with the instructions, may cause harmful interference to radio communications. However, there is no guarantee that interference will not occur in a particular installation. If this equipment does cause harmful interference to radio or television reception, which can be determined by turning the equipment off and on, the user can try to correct the interference by one of the following measures:
- (a) Reorient or relocate the receiving antenna.
 - (b) Increase the separation between the equipment and the receiver.
 - (c) Connect the equipment into an outlet on a circuit different from that to which the receiver is connected.
 - (d) Consult the dealer or an experienced radio/TV technician for help.

NOTES

A Note About Recycling

This product's packaging materials are recyclable and can be reused. Please dispose of any materials in accordance with your local recycling regulations. Batteries should never be thrown away or incinerated but disposed of in accordance with your local regulations concerning chemical wastes.

About Copyright

Unauthorized copying, broadcasting, public performance and lending of discs are prohibited.

This product incorporates copyright protection technology that is protected by method claims of certain U.S. patents and other intellectual property rights owned by Macrovision Corporation and other rights owners. Use of this copyright protection technology must be authorized by Macrovision Corporation, and is intended for home and other limited viewing uses only unless otherwise authorized by Macrovision Corporation. Reverse engineering or disassembly is prohibited.

Notice for progressive scan outputs

Consumers should note that not all high definition television sets are fully compatible with this product and may cause artifacts to be displayed in the picture. In case of 480 progressive scan picture problems, it is recommended that the user switch the connection to the "standard definition" output. If there are questions regarding our TV set compatibility with this model 480p DVD player, please contact our customer service center.

Supplied Accessories

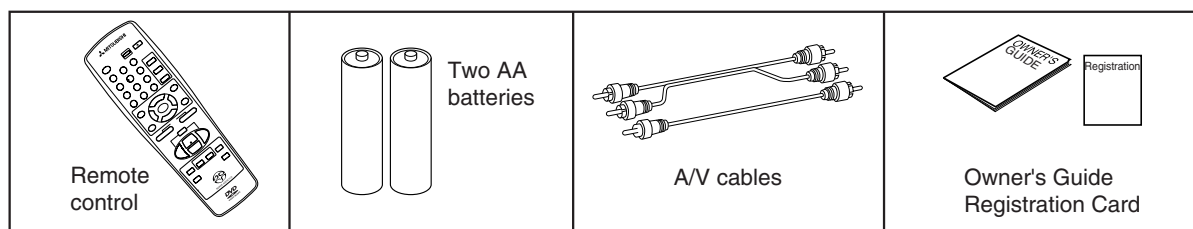

The serial number of this product may be found on the back of the DVD player. No others have the same serial number as yours. You should record the number and other vital information here and retain this book as a permanent record of your purchase to aid identification in case of theft. Serial numbers are not kept on file.

Symbols Used in This Manual

The following symbols appear below some headings and in some notes in this manual.

DVD-V :Refers to playback of DVD Video discs.

DVD-A :Refers to playback of DVD Audio discs.

DVD-RW :Refers to playback of the VR mode (Video Recording format).
VR-mode *The VR mode (Video Recording format) is a recording mode to enjoy editing the program or "manual mode" for recording in desired resolution and time.

CD :Refers to playback of audio CDs.

SUPER AUDIO CD :Refers to playback of Super audio CDs (or SACD).

MP3 :Refers to playback of MP3 discs.

JPEG :JPEG video data recorded onto CD (CD-R and CD-RW) can be displayed.

WMA :Windows Media Audio (WMA) can be played back.

VCD :Refers to playback of Video CDs.

Picture CD :Kodak Picture CD standard can be played back.

RW
COMPATIBLE

This label indicates playback compatibility with DVD-RW discs recorded in VR mode (Video Recording Format).

TABLE OF CONTENTS

■ IMPORTANT SAFEGUARDS	3
■ NOTES	5
■ FEATURES	7
■ ABOUT THE DISCS	8
PLAYABLE DISCS	8
DISC TYPES	8
■ OPERATING CONTROLS AND FUNCTIONS	9
DISPLAY	10
DISPLAYS DURING OPERATION	10
LOADING THE BATTERIES	10
■ HOOKUPS	11
CONNECTING TO A TV	11
CONNECTING TO A DOLBY DIGITAL DECODER OR DTS DECODER	12
CONNECTING TO A TV OR A STEREO TV THAT HAS COMPONENT VIDEO IN JACKS	12
CONNECTING TO AN AMPLIFIER EQUIPPED WITH DIGITAL INPUT JACKS SUCH AS MD DECK OR DAT DECK	13
■ PLAYING A DISC	14
PLAYING A DVD VIDEO OR AN AUDIO CD	14
USING THE DVD MENUS	14
PLAYING A DISC RECORDED IN THE VIDEO RECORDING FORMAT	14
USING THE TITLE MENU	15
PAUSING PLAYBACK OR DISPLAYING A STILL PICTURE	15
RESUMING PLAYBACK FROM THE POINT WHERE PLAYBACK STOPPED	15
STEPPING THROUGH FRAMES	15
PAGE SELECTION	16
FAST FORWARD/REVERSE	16
SLOW MOTION	16
STARTING FROM A DESIRED TRACK	16
PLAYING FROM A DESIRED GROUP	17
TO PLAYBACK THE BONUS GROUP	17
PLAYING FROM A DESIRED TITLE OR CHAPTER	17
STARTING FROM A DESIRED TIME COUNT	17
MARKER SETUP SCREEN	18
RANDOM (CD / Super Audio CD / DVD-A)	18
REPEAT	18
A-B REPEAT	19
PROGRAM (CD / Super Audio CD / DVD-A)	20
PLAYBACK OF ALL GROUPS	20
ZOOM PLAYBACK (enlargement on-screen)	20
PLAYING MP3 / JPEG IMAGE, WMA AND PICTURE CD	21
PLAYING MP3 DISC / JPEG DISC / WMA / PICTURE CD IN A PROGRAMMED WAY	23
PLAYING AN MP3 DISC / JPEG DISC / WMA DISC FROM A DESIRED TRACK	23
PLAYING AN MP3 DISC / JPEG DISC / WMA DISC / PICTURE CD AT RANDOM	23
■ SETTINGS	24
CHANGING THE AUDIO LANGUAGE OR SOUND MODE	24
CHANGING THE SUBTITLE LANGUAGE	25
CHANGING THE CAMERA ANGLE (Multi-Angle Pictures)	25
CHANGING THE ON-SCREEN DISPLAY	26
SETTING IMAGE QUALITY ADJUSTMENT	27
■ CHANGING THE SETUP ITEMS	29
LANGUAGE SETTINGS	29
LANGUAGE CODE LIST	30
DISPLAY SETTINGS	31
AUDIO SETTINGS	32
PARENTAL LOCK	34
■ TROUBLESHOOTING GUIDE	35
■ HANDLING PRECAUTIONS	36
■ SPECIFICATIONS	38
■ MITSUBISHI DVD Player LIMITED WARRANTY	40

FEATURES

- **Progressive Scan system**

Unlike conventional interlace scanning, the progressive scan system provides less flickering and images in higher resolution than that of traditional television signals.
- **Dolby Digital sound**

This player can handle Dolby Digital surround sound with 5.1 channels when connected to a Dolby Digital decoder.
- **DTS (Digital Theater System)**

You can enjoy 5.1 channel surround system developed by Digital Theater System which reproduces the original sound as truthfully as possible.
- **Still/fast/slow/step playback**

Various playback modes are available including still pictures, fast forward/reverse, slow motion and step frames.
- **Random playback for DVD Audio / Audio CD / Super Audio CD / MP3 / JPEG / WMA / Picture CD**

This player can shuffle the order of tracks to play them in random order.
- **Program playback for DVD Audio / Audio CD / Super Audio CD / MP3 / JPEG / WMA / Picture CD**

You can program the order of tracks to play them in any desired order.
- **DVD menus in a desired language**

You can display DVD menus in a desired language, if available on a DVD.
- **Screen saver/Auto power-off functions**

The screen saver program starts when there is no input from the player for 5 minutes in the stop mode. When the screen saver program is activated for 35 minutes, the power is automatically turned off.
- **Subtitles in a desired language**

You can select a desired language for the display subtitles, if that language is available on a disc.
- **Selecting a camera angle**

You can select the desired camera angle, if a disc contains sequences recorded from different angles.
- **Choices for audio language and sound mode**

You can select the desired audio language and sound mode, if different languages and modes are available on a disc.
- **Parental lock**

You can set the control level to limit playback of discs which may not be suitable for children.
- **Automatic detection of discs**

This player automatically detects if a loaded disc is DVD Video, DVD Audio, audio CD, Super Audio CD, MP3, JPEG, WMA on disc, Video CD, Picture CD.
- **Playing an MP3 disc**

You can enjoy MP3 files which are recorded on CD-R/RW.
- **Direct Search**

You can search the desired title, chapter, and track with numeric button during playback or in stop mode.
- **Marker**

You can memorize your favorite places on a disc.
- **On-screen display**

Information about the current operation can be displayed on a TV screen, allowing you to confirm the currently active functions (such as program playback), on the TV screen using the remote control.
- **Search**

Chapter search: Search for the chapter designated by user.
Title search: Search for the title designated by user.
Group search: Search for the group designated by user.
Track search: Search for the track designated by user.
Time search: Search for the time designated by user.
- **Repeat**

Chapter: Repeated playback of the chapter of the disc being played is possible.
Title: Repeated playback of the title of the disc being played is possible.
Track: Repeated playback of the track of the disc being played is possible.
All: Repeated playback of the entire disc being played is possible.
A-B: The part between A and B designated by user is possible.
Group: Repeated playback of the folder of the MP3/JPEG/WMA disc being played is possible.
- **Zoom**

1.3, 2-time and 4-time magnified screen can be displayed.
- **Resume Play**

User can resume to playback from the part at which the play was stopped even if the power is turned off.
- **Component Video Out Jacks**

Jacks located on the back of the DVD Player which are used to send high-quality video to a TV via Component Video In Jacks.
- **Dimmer**

Brightness of the display can be adjusted.
- **Bit rate indication**
- **DRC (Dynamic Range Control)**

You can control the range of sound volume.
- **Playing a disc in Video Recording Format (VR)**

The product can run a disc recorded in the Video Recording Format (VR mode).
- **JPEG Photo Viewer**
- **Kodak Picture CD playback**
- **WMA playback**
- **Adjusting image quality**

The user can adjust the degree of image quality mode, gamma correction, sharpness, color depth and hue.
- **Speech Control**

Playback in slightly faster / slower speed while keeping the sound quality in normal playback. Speech control is available only on discs recorded in the Dolby Digital format.
- **Reproducing WMA data**

You can enjoy WMA files which are recorded on CD-R/RW.

“Kodak Picture CD COMPATIBLE” is trademark of Eastman Kodak Company.

“WMA” (Windows Media Audio) is a new audio codec developed by Microsoft® in the United States of America.

ABOUT THE DISCS

PLAYABLE DISCS

The following discs can be played back on this DVD player.

Usable discs	Mark (logo)	Recorded signals	Disc Size
DVD-Audio		Digital video (MPEG2)	12 cm
DVD-Video (NOTE 1)			
DVD-R			8 cm
DVD-RW (NOTE 3)			
CD CD-R CD-RW (NOTE 4)	 	Digital audio MP3 WMA (NOTE 5) Digital picture (JPEG)	12 cm 8 cm
Super Audio CD		Digital audio	12 cm
Video CD	 	Sound and Pictures	12 cm 8 cm (Singles)
Picture CD		JPEG	12 cm

NOTE 1: Some DVD-Video discs do not operate as described in this manual due to the intentions of the discs' producers.
 NOTE 2: This unit can play DVD-RW discs recorded in DVD video format or DVD video recording format (VR mode).
 * The disc may not be played back due to recording quality or properties of the disc, dirt on the disc or the pickup lens, or condensation on the pickup lens.
 NOTE 3: Discs that have not been finalized cannot be played.
 Depending on the disc's recording status, the disc may not be accepted or may not be played normally (the picture or sound may not be smooth, etc.).
 NOTE 4: Some of CD-R/CD-RW discs may be incompatible because of "scratch and stain of disc", "Recording condition", and "Characteristic of Recorder".
 NOTE 5: Windows Media and the Windows logo are trademarks or registered trademarks of Microsoft Corporation in the United States and/or other countries.

This player conforms to the NTSC color system. You cannot play discs recorded in other color systems such as PAL or SECAM.

- Some discs include region codes as shown below.



- The number inside the symbol refers to a region of the world, and a disc encoded in a specific region format can only be played back on DVD players with the same region code.

RW : This label indicates playback compatibility with DVD-RW discs recorded in VR mode (Video Recording Format).

The following discs cannot be played back on this DVD player.

- DVD with region codes other than 1 or ALL.
- DVD-ROM
- DVD-RAM (Never play back, otherwise malfunction may result.)
- CD-ROM
- VSD
- CDV (Only plays back the audio part.)
- CD-G (Only plays back the sound.)
- CD-R/CD-RW (Only plays back the discs which audio CD/MP3/JPEG/WMA is recorded.)
- CD-I (Never play back, otherwise malfunction may result.)
- Photo CD (Never play back, otherwise malfunction may result.)
- Any other discs without compatibility indications.

DISC TYPES

[DVD][DVD-RW]

Data on a DVD is divided into sections called "titles," and then into subsections called "chapters," each of which is given a title or chapter number. Playback conditions are preset on some DVD Video discs, and these playback conditions take priority over user operations on this player. If a function you selected does not run as desired, refer to the manual accompanying the disc.

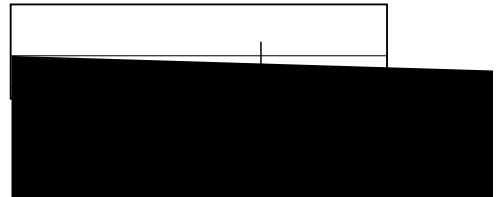
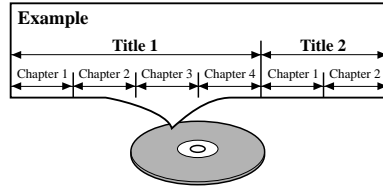

[AUDIO CD][SUPER AUDIO CD][VIDEO CD]

Data on an audio CD, a Super Audio CD or a Video CD is divided into sections called "tracks," each of which is given a track number.

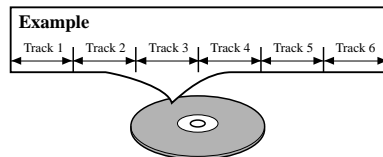

[MP3][JPEG][WMA]

These files are divided into sections called "groups," and then into subsections called "tracks," each of which is given an album or track number.

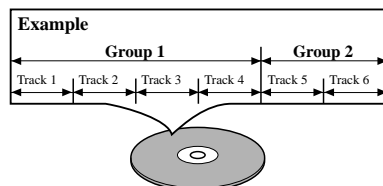

OPERATING CONTROLS AND FUNCTIONS

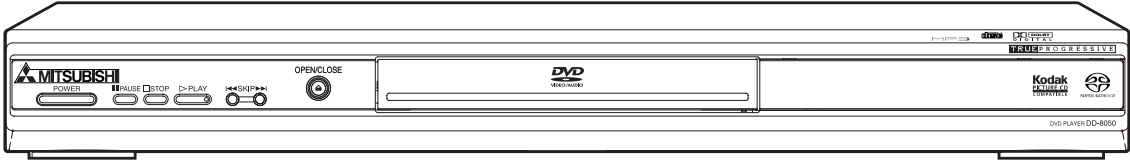

REAR VIEW

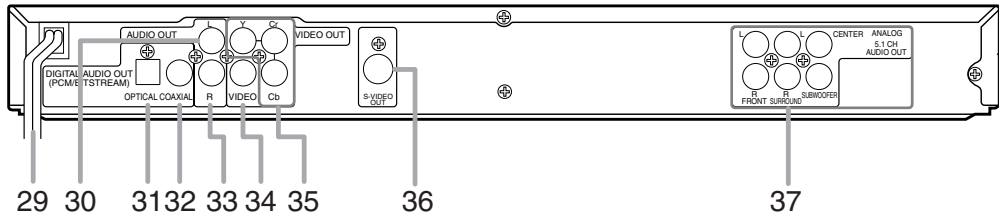

- 29. Power Cord
- 30. Left AUDIO OUT Jack
- 31. OPTICAL DIGITAL AUDIO OUT Jack
- 32. COAXIAL DIGITAL AUDIO OUT Jack
- 33. Right AUDIO OUT Jack

- 34. VIDEO OUT Jack
- 35. COMPONENT VIDEO OUT Jacks
- 36. S-VIDEO OUT Jack
- 37. ANALOG 5.1 CH AUDIO OUT Jacks

DISPLAY

Lights up when the A-B repeat function is on.

Displays a type of the disc which is inserted on the tray.

- DVD : DVD disc
- DVD A : DVD-audio
- VCD : VCD
- CD : Audio CD, MP3, JPEG, PictureCD, WMA

Lights up when playing MULTI-CH AREA on Super Audio CD.

Lights up when Progressive Scan is on.

Lights up when playing a Super Audio CD.

Lights up when the repeat function is on.

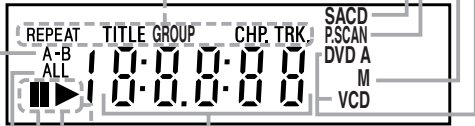

Displays how long the current title or track has been played back. When a chapter or track is switched, the number of a new title, chapter or track is displayed.

Lights up when the playback is slow mode.

Lights up when the inserted disc is being played back.

Lights up when the inserted disc comes to a pause.

Lights up when the ALL repeat function is on.

It is possible to change the brightness of display unit by pressing the DIMMER button of remote control.

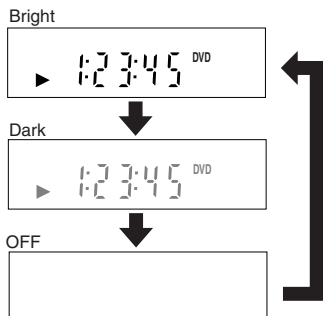

- When the power supply is turned off, the display is returned to the setup status.

DISPLAYS DURING OPERATION

00	Power on
- - - -	No disc inserted or playing DVD menu
OPEN	Opening the Tray
CLOSE	Closing the Tray
Load	Loading the disc
Pbc	Lights up when the playback control is activated (VCD)
OFF	Power off

LOADING THE BATTERIES

1. Open the battery compartment cover.
2. Insert two AA batteries, with each one oriented correctly.
3. Close the cover.



Notes

- Do not mix alkaline and manganese batteries.
- Do not mix old and new batteries.

HOOKUPS

CONNECTING TO A TV

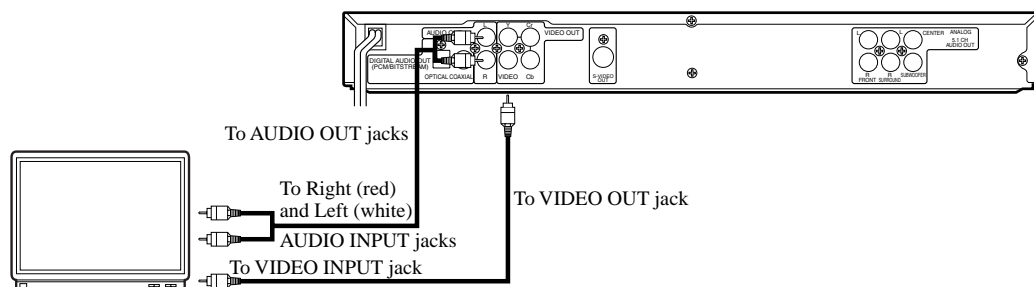

FOR TVs WITH S-VIDEO INPUT JACK

Use an S-Video cable (commercially available) in place of the yellow video cable to enjoy pictures at higher quality.

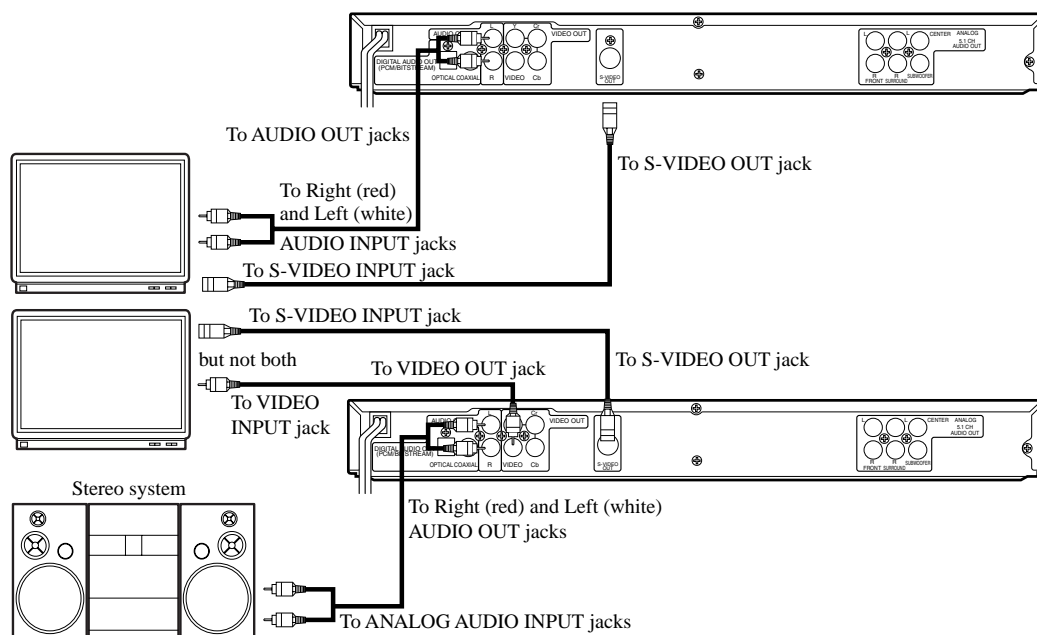

Notes

- Connect the DVD player directly to a TV. If the A/V cables are connected to a VCR, pictures may be distorted due to the copy protection system.
- Be sure to turn off the power to all components in the system before connecting another component.
- Refer to the Owner's Guides for your TV, stereo system and any other components to be connected to the DVD player.

Selecting 480p Progressive Scan or 480i Interlaced Playback

- If your TV is compatible with 480p progressive scanning, connect the TV to the Component Video Output jacks of the DVD player and set "PROGRESSIVE" to "PROGRESSIVE" in the display setting. Next, set your TV to the progressive scan mode. Refer to pages 31 and 32 for instructions on changing the display setting.
- If your TV is not compatible with progressive scan, set "PROGRESSIVE" to "INTERLACE".
- Use a commercially available adaptor if the video input jacks of your TVs or monitors are the BNC type.

What is Progressive Scanning?

- Unlike conventional interlace scanning, the progressive scan system provides less flickering and images in higher resolution than that of traditional 480i television signals.

CONNECTING TO A DOLBY DIGITAL DECODER OR DTS DECODER

If using this DVD player to playback a DVD in a 5.1 channel Dolby Digital surround or DTS surround format, the DVD player outputs a Dolby Digital or DTS data stream from its OPTICAL or COAXIAL DIGITAL AUDIO OUT jacks. 5.1 channel Dolby Digital Surround sound can also be output from the 5.1 CH OUTPUT jacks. (They do not output the DTS sound.) By hooking the player up to a Dolby Digital or DTS decoder, you can enjoy a more convincing, realistic ambience with powerful and high-quality surround sound of a professional standard, which can be heard in movie theaters. Use an audio coaxial or optical digital cable (not included) for the audio connections. Use audio cables (commercially available) for the 5.1 CH audio connection.

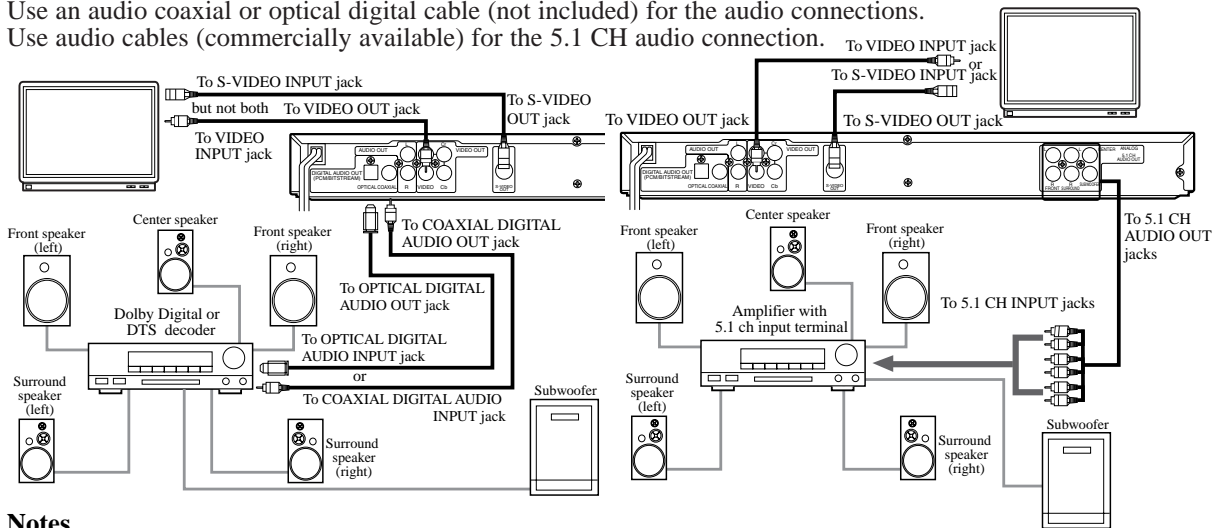

Notes

- Be sure to turn off the power to all components in the system before connecting another component.
- Refer to the Owner's Guides for the components to be connected to the DVD player.
- If output is Dolby Digital audio, connect to a Dolby Digital decoder and set "DOLBY DIGITAL" to "ON" for audio output in the setup mode.
- If you want to enjoy DTS audio, use a DIGITAL AUDIO OUT jack for the connection.
- If output is DTS audio, connect to a DTS decoder and set "DTS" to "ON" for audio output in the setup mode.
- Unless connected to a Dolby Digital decoder or a DTS decoder, set "DOLBY DIGITAL" or "DTS" to "OFF" for audio output in the setup mode. Playing a DVD using incorrect settings may generate noise distortion and may also damage the speakers.

Manufactured under license from Digital Theater Systems, Inc. U.S. Pat. No's.5,451,942; 5,956,674; 5,974,380; 5,978,762; 6,226,616; 6,487,535 and other U.S. and world-wide patents issued and pending. "DTS" and "DTS Digital Surround" are registered trademarks of Digital Theater Systems, Inc. Copyright 1996, 2003 Digital Theater Systems, Inc. All Rights Reserved.

Manufactured under license from Dolby Laboratories. "Dolby" and the double-D symbol are trademarks of Dolby Laboratories.

CONNECTING TO A TV OR A STEREO TV THAT HAS COMPONENT VIDEO IN JACKS

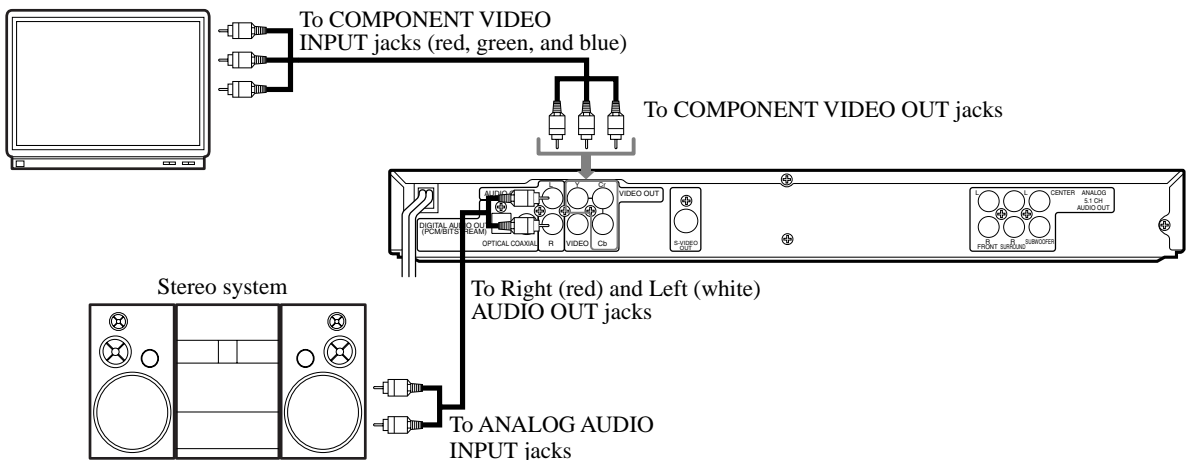

CONNECTING TO AN AMPLIFIER EQUIPPED WITH DIGITAL INPUT JACKS SUCH AS MD DECK OR DAT DECK

Use an audio coaxial or optical digital cable (not included) for the audio connections.

Connecting to an amplifier equipped with digital input jacks such as MD Deck or DAT Deck:

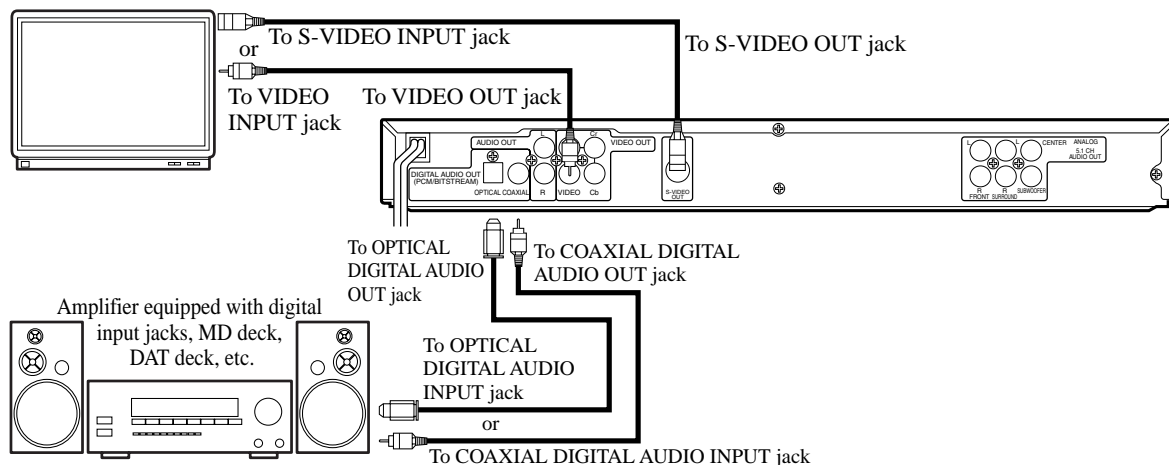

Notes

- The audio source on a disc in a 5.1 channel Dolby Digital surround format cannot be recorded as digital sound by an MD or DAT deck.
- Be sure to turn off the power to all components in the system before connecting another component.
- Refer to the Owner's Guides for the components to be connected to the DVD player.
- Set "DOLBY DIGITAL" and "DTS" to "OFF" for audio output in the setup mode. Playing a DVD using incorrect settings may generate noise distortion, and may also damage the speakers (See page 32 to set "ON" for "DOLBY DIGITAL" and "DTS").
- Super Audio CD sound is not output as digital sound.

HOW TO CONNECT TO A TV WITHOUT AUDIO/VIDEO INPUT JACKS

If your TV does not have RCA type audio and video input jacks, it is still possible to connect this DVD player to your TV's 75-ohm coaxial antenna terminal using a commercially available Stereo Audio/Video RF Modulator that is not included. Connect the audio and video outputs of the DVD player to the audio and video inputs on the RF Modulator, and then connect the coaxial output of the RF Modulator (usually marked "TO TV") to the 75-ohm coaxial antenna terminal on your TV. Follow the instruction supplied with the RF Modulator for more details.

If your TV's 75-ohm coaxial antenna terminal is already occupied by an antenna or cable box connection, remove that cable from your TV's antenna terminal and reconnect it to the coaxial antenna input terminal of the RF Modulator (usually marked "ANT IN"), then connect the RF modulator to your TV's antenna terminal as described above.

Note

- The picture quality from DVD discs will not be as good if the DVD player is connected to the TV's antenna terminal through an RF Modulator.

HINT FOR OPTICAL CABLE (NOT SUPPLIED)

- Optical cable (not supplied) may be damaged when bent at acute angles. Ensure cables are coiled in loops with a diameter of 6 inches or more when storing them.
- Use a cable which is 9.8 feet or shorter.
- Insert cable plugs firmly into the jacks when making connections.
- If a plug has minor scratches or is dirty, clean it with a soft cloth before inserting it into a jack.
- Replace the protective cap on the OPTICAL jack when it is not in use.

PLAYING A DISC

PLAYING A DVD VIDEO OR AN AUDIO CD

DVD-A DVD-V DVD-RW CD VCD

VR-mode

SUPER AUDIO CD MP3 JPEG

Picture CD WMA

Getting started

Turn on the power of the TV, amplifier and any other components which are connected to the DVD player. (Change the input system to suit the DVD player, and check that the sound volume is correct.)

1 Press the POWER button.

- The power will turn on.

2 Press the OPEN/CLOSE button.

- The disc loading tray will open.

3 Place a disc into the tray.

- Make sure the disc is sitting properly in the correct recess, with the label side up. Discs that are irregularly shaped, contain a scratch protection film, or have any type of sticker or adhesive label should not be inserted.

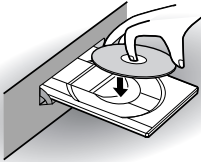

4 Press the PLAY button.

- The tray will close automatically, and playback will then start from the first chapter or track of the disc. You need to press the PLAY button only when the tray has been closed by pressing the OPEN/CLOSE button.
- When you playback a DVD Video, DVD Audio or Video CD which a title menu is recorded, it may appear on the screen. In this case, refer to "USING THE TITLE MENU."

5 Press the STOP button to stop play.

Notes

- A "prohibited icon" may appear at the top-right on the TV screen during operation, warning that a prohibited operation has been encountered by the DVD player or the disc. 
- If a disc is dirty or has scratches, the pictures may appear distorted and the playback operation may stop. In such cases, clean the disc and unplug the power cord and then plug it again before resuming playback. Never attempt to play a cracked or broken disc!
- With DVDs that use some titles for playback program signals, playback may start from the second title, or it may skip these titles.
- During the playback of a common two layered disc, pictures may stop for a moment. This happens when the 1st layer switches to the 2nd layer. This is not a malfunction, and is commonly found on pre-recorded discs.

- Operation may vary when you playback DVDs with a disc menu. Refer to the manual accompanying the disc for details.
- During the playback of DVD-RW recorded in VR mode, the sound or picture may freeze momentarily depending on the writing conditions of discs.
- Operation may vary when you playback DVDs with a disc menu or Video CDs with PBC. Refer to the manual accompanying the disc for details.
- When you playback Video CDs with PBC, the time counter does not appear on the display.

Cancelling PBC (for playback of a Video CD)

1. Insert a Video CD (Playback will start automatically).
2. Press the STOP button.
3. Enter track number of your choice with the numeric buttons.
4. PBC is now cancelled and the playback of the Video CD will start.

USING THE DVD MENU

DVD-V

Some DVDs contain their own menus, such as a guidance menu which describes the contents of the disc or a selection menu for sound, language and other customized settings.

1 Press the MENU button.

- The DVD menu will appear.

2 Select the desired title.

- Press the Arrow buttons (▲/▼/◀/▶) to change the setting, and then press the ENTER button.

3 Playback will start from the selected title.

PLAYING A DISC RECORDED IN THE VIDEO RECORDING FORMAT

DVD-RW
VR-mode

The user can select either "Original" or "Play list" before playing the disc if a "Play list" has been set in the disk recorded in the Video Recording Format.

1 Press the MENU button when the system is at rest.

- The menu screen of the currently set state appears.

2 Using the arrow buttons (◀/▶) select "Original" or "Play list".

- The menu screen does not display any play list unless a play list has been created.
- When the setting state is switched, "resume" will be released.
- If the list contains eight or more titles, the user may turn the page using SKIP buttons ◀◀ or ▶▶.

3 Using the arrow buttons (▲/▼) select the desired title to play.

USING THE TITLE MENU

With a DVD containing a title menu, you can select desired titles from the menu.

1 Press the TITLE button.

- The title menu will appear.
-

2 Select the desired title.

- Press the Arrow buttons (▲/▼/◀/▶) to change the

PAGE SELECTION

DVD-A

Some DVD Audio discs that include still images are provided with a selection of images you can choose from.

1 Press the ANGLE/PAGE button during playback.

- The current page number and the total page number will appear.

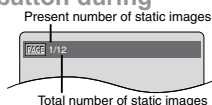

2 Press the ▲ or ▼ button to select desired page number.

3 Press the Return button to exit.

FAST FORWARD/REVERSE

DVD-A DVD-V CD VCD

SUPER AUDIO CD MP3 WMA

DVD-RW
VR-mode

1 Press the FWD ►► or REV ◀◀ button during playback.

- For DVD Videos, pressing the FWD ►► or REV ◀◀ button cycles the playback speed in four steps. In case of DVD Videos, the sound will mute. Turning on the double-speed sound in SET UP enables output of sound.
- For DVD audios, the playback speed is $\times 2$, $\times 8$ $\times 50$ and $\times 100$. In case of DVD Audio discs, the sound will not mute.
- For audio CDs and Super Audio CD, the playback speed is $\times 16$ fixed.
- For Video CDs, the playback speed is $\times 2$, $\times 8$ and $\times 30$.
- For WMA and MP3, the playback speed is $\times 8$ fixed.

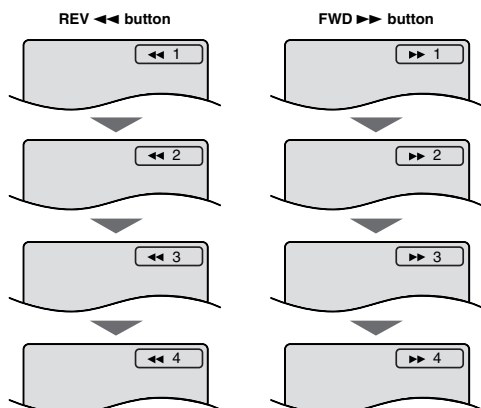

2 Press the PLAY button to return to normal playback speed.

Note

- Set "STILL MODE" to "FIELD" in the "DISPLAY" menu if pictures in the pause mode are blurred. (for DVD play only) Refer to pages 31 and 32

SLOW MOTION

DVD-A DVD-V DVD-RW VCD

VR-mode

1 Press the FWD ►► or REV ◀◀ button while playback is paused. (Sound remains muted.) Press FWD ►► or REV ◀◀ repeatedly to select the required speed.

- Slow forward or reverse speed is different depending on the disc. Approximate speed is $1(1/16)$, $2(1/8)$, and $3(1/2)$.

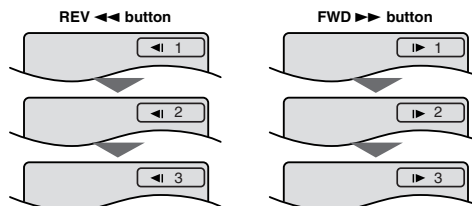

2 Press the PLAY button to return to normal playback speed.

Notes

- Slow playback is not available with audio CDs, Super Audio CD, MP3, WMA.
- Reverse slow motion is not available with Video CD.
- For DVD Audio discs, slow playback can be done only for pictures.
- Set "STILL MODE" to "FIELD" in the "DISPLAY" menu if pictures in the pause mode are blurred. (for DVD play only) Refer to pages 31 and 32

STARTING FROM A DESIRED TRACK

DVD-A CD SUPER AUDIO CD

VCD (without PBC function) MP3 JPEG Picture CD

WMA

1 Press the Numeric buttons to enter the desired track number.

- The selected track will be located, and playback will start.

You can also press the SEARCH MODE button, by using the Numeric buttons to enter the track number. When the track number is entered in the entry box, playback of the desired track will start automatically.



Notes

- During play, a desired track can be directly searched. To do so enter the TRACK number with the Numeric buttons.
- If the entered TRACK number is not available, the "disable" symbol appears and the direct search mode is cancelled.

TRICKS WITH THE SKIP BUTTONS (◀◀, ►►)

If the SKIP button ►► is pressed during playback or while playback is paused, the current track will be skipped and the next track will be played. When the SKIP button ◀◀ is pressed once, the top of the current track will be located for replaying. When the SKIP button ◀◀ is pressed again within 2-seconds after playback begins, the previous track will be located.

PLAYING FROM A DESIRED GROUP

DVD-A

- 1 Press the SEARCH MODE button until the screen appears and then press the numeric buttons to select a group. When playback is stopped, press the numeric buttons to select a Group. The Group will be located and playback will start.



TO PLAYBACK THE BONUS GROUP

DVD-A

Some discs are recorded with Bonus Group that can be played back by entering a password. Please refer to disc jackets also.

- 1 Search the bonus group during stop mode to open the group search screen.
- 2 Press the bonus group number using numerical buttons.

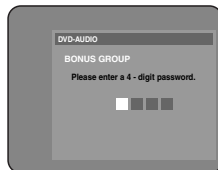

- The password popup window opens.

- 3 Enter the password (4 digits) using numerical buttons.

- If the password is correct, playback starts from the head of the bonus group.

Notes

- Press the RETURN button to cancel the bonus group searching.
- Once the password is entered, it can be played back repeatedly until the disc is taken out.
- If the password is not entered, the bonus group cannot be searched during playback.

PLAYING FROM A DESIRED TITLE OR CHAPTER

DVD-V

DVD-RW

VR-mode

- 1 Press the SEARCH MODE button and then press the Numeric buttons to select a title or a chapter.
- 2 Enter the desired chapter/title number using the Numeric buttons.

- During playback, press the Numeric buttons to select a Chapter. The Chapter will be located and playback will start.
- When playback is stopped, press the Numeric buttons to select a Title. The Title will be located and playback will start.



Notes

- Playback from a desired title or chapter is not available with some DVDs.
- Some discs in which the chapter number isn't displayed, can not playback from a desired chapter.

TRICKS WITH THE SKIP BUTTONS (◀◀, ▶▶)

If the SKIP button ▶▶ is pressed during playback or while playback is paused, the current chapter will be skipped and the next chapter will be played. When the SKIP button ◀◀ is pressed once, the top of the current chapter will be located for replaying. When the SKIP button ◀◀ is pressed again within 2-seconds after playback begins, the previous chapter will be located.

STARTING FROM A DESIRED TIME COUNT

DVD-A

DVD-V

DVD-RW

CD

VR-mode

SUPER AUDIO CD

VCD (without PBC function)

- 1 Press the SEARCH MODE button repeatedly during playback.
- 2 Press the Numeric buttons to set the desired time count.

- **Example:** 1 hour, 23 minutes and 30 seconds
1 2 3 3 0



Notes

- In the case of DVD, Time Search in Title is effective, but Time Search in Chapter is ineffective.
- In the case of CD, Time Search in Track is effective, but Time Search in the entire disc is ineffective.
- Playback from a desired time count is not available with some discs or if the unit is in stop mode.
- If wrong numbers are entered, press the CLEAR button and re-enter the correct numbers.
- When there is no need to enter a number, "0" appears automatically. For example, "0:0:_ _" appears in the Time Search display if the total time of the disc is less than 10 minutes.

MARKER SETUP SCREEN



Use markers to memorize your favorite places on a disc.

- 1 Press the **SEARCH MODE** button repeatedly during playback.
 - The display screen and Markers will appear on the TV screen.
- 2 Press **◀** or **▶** to select 1, 2, 3, 4, 5, 6, 7, 8, 9 or 10 and ensure that “- : - : - : - : - :” appears in the display.
- 3 When reaches the desired point, press the **ENTER** button.
 - The Title or Track and elapsed playing time will appear in the TV screen.
- 4 To return to the Marker later, press the **SEARCH MODE** button repeatedly during playback, and **◀** or **▶** to choose the desired marker, then press the **ENTER** button.

Notes

- Opening the disc tray, turning off the power, or selecting AC at step 2 and pressing the **ENTER** button will erase all Markers.
- To clear a marker, using **◀** or **▶**, position the cursor on to the marker number to be cleared and press **CLEAR** button.
- You can mark up to 10 points.
- In the case of DVD Audios, marker searching may start playback from the head of the marked TR, in some discs or groups.

- 5 Press the **SEARCH MODE** button or the **RETURN** button to exit.

RANDOM (CD / Super Audio CD / DVD-A)



- 1 Press the **MODE** button in stop mode.
 - The program setting menu screen will appear.

- 2 Press the **MODE** button again.

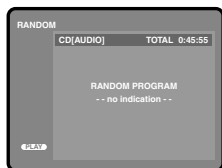

- 3 Press the **PLAY** button. Random playback will then start.

Note

- Program playback is not available during random playback.

DVD-A

- 1 Press the **MODE** button repeatedly in stop mode until the random setting menu screen will appear.



- 2 Press **▲/▼** buttons to select the group you wish to playback randomly, then press the **PLAY** or **ENTER** button, Random playback will then start.

Notes

- During random playback, **TITLE**, **MENU**, **Arrow** and **ENTER** buttons on the remote controller are disabled.
- When the designated random playback ends, it changes to stop mode.

REPEAT

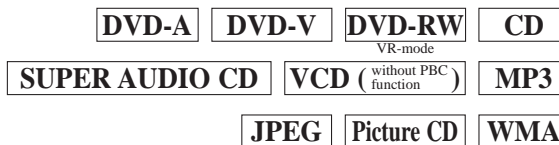

- 1 Press the **REPEAT** button.

For DVDs

- A single title or chapter is played back repeatedly.
- Pressing the **REPEAT** button cycles the display on the screen as follows.

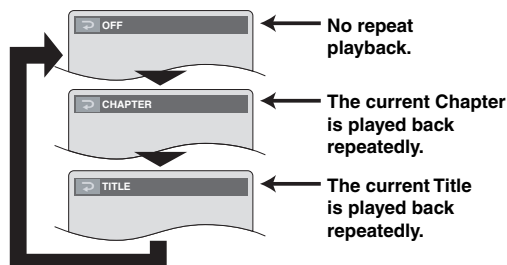

DVD-RW VR-mode

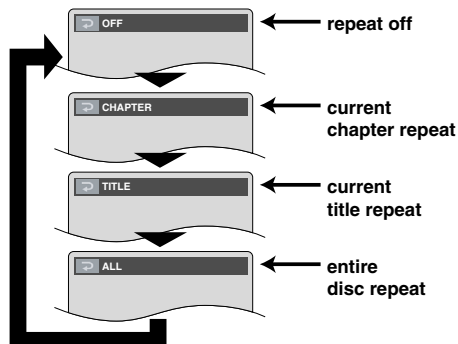

Notes

- Repeat Title/Chapter is not available with some scenes.
- The REPEAT setting will be cleared when moving to other title or chapter.
- Repeat playback does not function during A-B repeat playback.

For audio CDs, Super Audio CD or Video CDs

- The whole disc or a single track is played back repeatedly.
- Pressing the REPEAT button cycles the display on the screen through **Off**, **Track** and **All**.

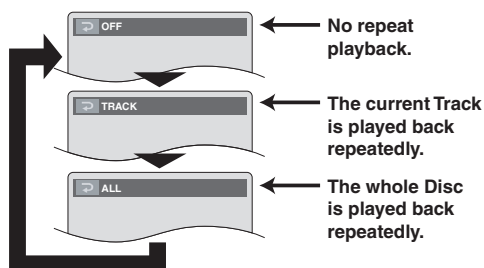

If the REPEAT button is pressed once during program/random playback, the current track is played back repeatedly.

If the REPEAT button is pressed again, the program/random playback is performed repeatedly.

Notes

- Repeat playback is not available with some discs.
- The REPEAT setting will be cleared when moving to another title, chapter or track.
- Repeat playback does not function during A-B repeat playback.
- Repeat playback is not available when you play the Video CD with PBC function.

For DVD Audio

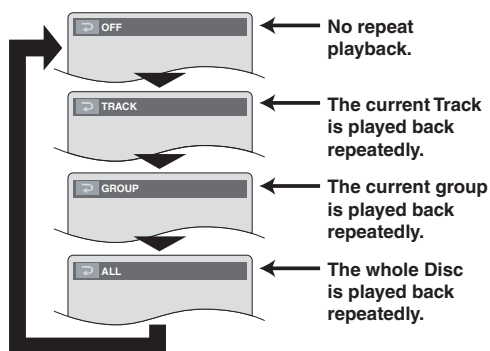

- Repeat playback does not function during A-B repeat playback.

For MP3s, JPEG, WMA and Picture CDs

- A track, group or all is played back repeatedly.
- Pressing the REPEAT button cycles the display on the screen as follows.

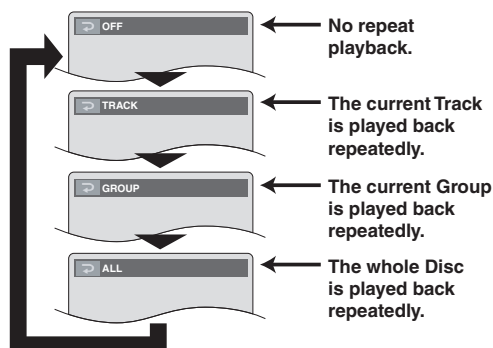

Notes

- Repeat playback is not available with some discs.
- The REPEAT setting will be cleared when moving to another track or group.

A-B REPEAT



You can define a section to be played back repeatedly.

1 Press the A-B REPEAT button during playback.

- The starting point (A) will then be selected.

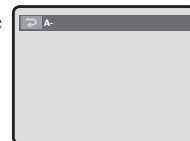

2 Press the A-B REPEAT button again at the end point (B) of the desired section.

- The selected section will be played back repeatedly.



3 To exit A-B repeat playback, press the A-B REPEAT button and set it to OFF.

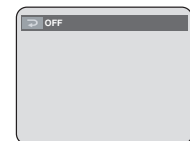

Notes

- With DVDs, the A-B repeat section can be set only within the current title.
- With DVD Audio and audio CDs, Super Audio CDs, Video CDs, the A-B repeat section can be set within the current track.
- A-B repeat is not available with some scenes in certain DVDs.
- To cancel the A point which was set, press the CLEAR button.
- A-B repeat playback does not function during title, chapter, track, group or all.

PROGRAM (CD / Super Audio CD / DVD-A)

CD

SUPER AUDIO CD

1 Press the MODE button in stop mode.

- The program screen will appear.

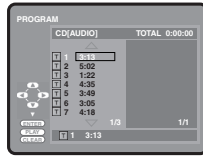

2 Select a track using ▲ or ▼ buttons, then press the ENTER button.

- If eight or more tracks have been set in a program, the user can switch the right part of the screen with ◀◀ or ▶▶.

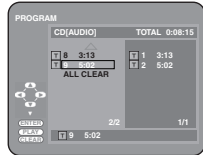

3 Press the PLAY button.

- Playback will start in the programmed order.
- While the program is being played back, the STOP button works as follows:
Press the STOP button once and then the PLAY button again, and playback will restart from the point where the STOP button was pressed (Program continued).
Press the STOP button twice and then the PLAY button again, and playback will restart from the track in the usual way (Program cleared).

Notes

- Adding programs is not possible during program playback. You must stop the current playback before such operations can be carried out.
- Press the CLEAR button to cancel a program. The most recently entered program will then be deleted.
- Up to 99 programs can be entered.
- To erase all tracks in the program at once, select ALL CLEAR at the bottom of the list at Step 2.
- Playback from a desired track and random playback are not available during program playback.
- Program settings are cleared when the power is turned off or the disc loading tray is opened.

DVD-A

1 In STOP mode, press the MODE button repeatedly until the program screen appears.



2 Select a group using ▲/▼ buttons, then press the ENTER button.

- The track select screen will be displayed.
- It takes approximately 5 seconds until a track selection screen appears.

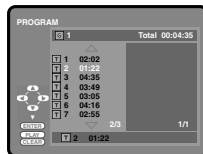

3 Select a track using ▲/▼ buttons and press the ENTER button.

- To return to the group select screen from the track select screen, press the RETURN button.

4 Press the PLAY button.

Notes

- It may take time for all the respective track times to be displayed.
- The programmed content is retained until the power is turned off or the tray is opened.
- During program playback, TITLE, MENU, Arrow and ENTER buttons on the remote controller are disabled.
- When the designated program playback ends, it changes to stop mode.

PLAYBACK OF ALL GROUPS

DVD-A

1 Press the MODE button in stop mode to display the all group screen.

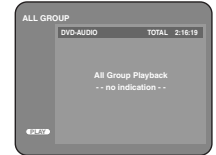

2 Press the PLAY button.

ZOOM PLAYBACK (enlargement on-screen)

DVD-V | DVD-RW | VCD | JPEG | Picture CD
VR-mode

Images can be enlarged on the screen to your taste.

1 Press the ZOOM button during playback.

- An image will be enlarged at the center of the screen.
- Pressing the ZOOM button cycles the zooming images in three steps.

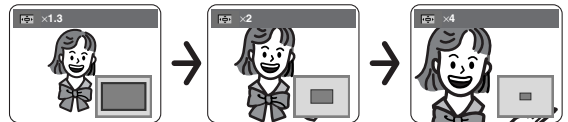

2 When the Arrow (▲/▼/◀/▶) buttons are pressed during zoom play, the part to be zoomed moves.

- The zooming frame can be moved from the center 4 steps to the right, 4 steps to the left, 4 steps to the top, and 4 steps to the bottom when 2 time zooming. The frames will move 6 steps when 4 time zooming. (In the 1.3-time zoom display, just one step can be shifted up and down as well as right and left.)
- Current position will be displayed on the right bottom of the screen. Press the ENTER button, and the display disappears.

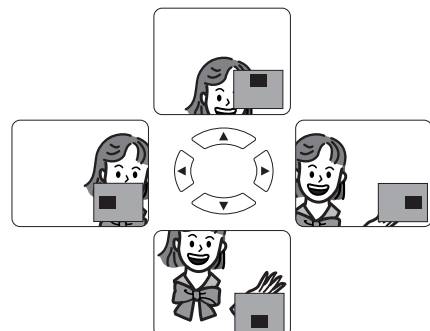

Notes

- Zooming function does not work while disc menu is shown.
- ×4 zoom is not available on some discs.
- Only ×2 zoom is available on JPEG, and Picture CD.
- For Video CDs, only 2 times zooming is available.

PLAYING MP3 / JPEG IMAGE, WMA AND PICTURE CD

MP3 **JPEG** **Picture CD** **WMA**

This player can reproduce images and sounds from data recorded in MP3, JPEG and WMA formats on CD-R and CD-RW discs.

The player can also run Picture CD by Kodak Inc. The user can enjoy picture images on their television set by reproducing picture CDs.

* Picture CD is a service that converts photographs taken by conventional film camera into digital data and writes the data on a CD.

For details on Picture CD, contact a shop that deals with the developing service of Kodak Inc.

1 Insert a disc and press the MENU button.

- The FILE LIST will appear on display. The number of tracks is also displayed on the front panel.

2 Press the Cursor buttons (▲ or ▼) to select the desired group (folder) or track.

- To return to the previous screen, press the ◀ button.
- If a group (folder) is selected, press the ▶ or ENTER button to go on to the track selection screen. Press the Cursor buttons (▲ or ▼) to choose a track, then press the PLAY or ENTER button.
- If a track is selected, press the PLAY or ENTER button to start playing tracks. The selected track and the subsequent tracks will be played.
- Press the TITLE button to return to the first item.

3 Press the STOP button to stop playback.

Notes

- An MP3, JPEG or WMA track menu screen appears.
- A symbol of “☐” is shown on the top of the group name.
- A symbol of “☐” is shown on the top of MP3 files.
- A symbol of “☐” is shown on the top of JPEG files.
- A symbol of “☐” is shown on the top of WMA files.
- If the picture extends beyond the scope of screen, a down arrow “▼” appears, indicating that the user can view another part of the picture on the next page. If an up arrow “▲” appears, it indicates that the user can view another part on the previous page. The current page number and the number of total pages are shown on the right of the down arrow “▼”.
- The system can recognize up to 255 groups (or folders) and up to 512 tracks. (This applies to the case where mixed MP3, JPEG and WMA files are recorded.)
- If no MP3, JPEG or WMA files are found in the group, the group is not displayed.

- The player can reproduce data recorded as per ISO 9660 Level 1, Level 2 or Joliet on the disc.
- It can also run a disc on which data is recorded in a multi-session.
- For more details of recording systems, see the instruction manual for the CD-R / CD-RW drive or the writing software.

Applicable MP3 file		Remarks
Sampling frequency	44.1kHz 48kHz	• It is prohibited to record MP3 sound on a digital device when connection is made digitally.
Type	MPEG1 audio layer 3	• MP3 files recorded at constant bit rate of 128 kbps or higher are recommended.

Applicable JPEG file		Remarks
Size of image	Upper limit: 6300×5100 dots Lower limit: 32×32 dots	• A JPEG image that extends beyond the screen is reduced so that it will be displayed within the screen.

Applicable WMA file		Remarks
Sampling frequency	44.1kHz 48kHz	• It is prohibited to record WMA sound on a digital device when connection is made digitally.
Bit rate	48–192kbps 128kbps recommended	• Ensure that the copyright function is set to off when preparing a WMA disc.
Type	WMA version 9	• A prohibition “disable” symbol will appear if the user attempts to run a copyright-protected file.

Information on MP3, JPEG and WMA discs

- A file with an extension of ".mp3 (MP3)" is called an "MP3 file".
- A file with an extension of ".jpg (JPG)" or ".jpeg (JPEG)" is called a "JPEG file".
- A file with an extension of ".wma (WMA)" is called a "WMA file". The DVD player can run an image file conforming to the Exit specification. Exit is a file format, Exchangeable Image File format established by Japanese Electronic Industry Development Association (JEIDA).
- Files whose extension is other than ".mp3 (MP3)", ".jpg (JPG)", ".jpeg (JPEG)" and ".wma (WMA)" will not be listed in the MP3 or JPEG menu.
- If the file is not recorded in MP3, JPEG or WMA format, noise may be produced even if the file extension is either ".mp3 (MP3)", ".jpg (JPG)", ".jpeg (JPEG)" and ".wma (WMA)".
- The ninth and deeper hierarchies cannot be played.
- The name of group and track can be displayed in up to 25 characters. Unrecognizable characters will be replaced with asterisks. The ninth and deeper hierarchies cannot be displayed.
- Unplayable groups or tracks may be displayed depending on the recording conditions.
- If the TITLE button is pressed when a file list is displayed, the first item will be highlighted.

For discs of Picture CD:

1 Press the MENU button in stop mode.

Kodak Picture CD menu appears.

- If all menu items cannot be displayed in the screen scope, “▶▶|” appears at the right bottom of the screen, indicating that the user can view remaining items on the next page. “|◀◀” appears, it indicates that the user can view other items on the previous page. The track number of the currently highlighted item and the total tracks are shown at the center bottom of the screen.
- If “▶▶|” is shown at the right bottom, use the SKIP ▶▶| button to view the next page. If “|◀◀” is shown at the left bottom, use the SKIP |◀◀ button to view the previous page.
- It may take some time until all menu items are displayed on the menu screen.

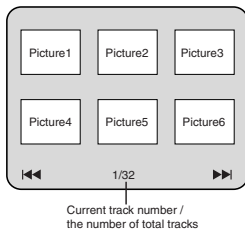

2 Press the Cursor buttons (▲ / ▼ / ◀ / ▶), select a desired track to be played, then press the PLAY or ENTER button.

- If a Kodak Picture CD file is selected, an image will be played back from the selected track and go to the next one in turn.

3 Press the STOP button, to stop playback.

Notes

- A track is displayed for 5 seconds and then the next track is displayed.
- Every press on the ▶ button will turn the image clockwise by 90 degrees when an image is displayed.
A press on the ◀ will turn the image counterclockwise by 90 degrees.

Slide show mode switching of JPEG, Picture CD

This player can switch the slide show modes.

1 Press the MODE button during JPEG or Picture CD playback.

- The slide show mode screen appears.



- The slide show mode cannot be switched when it is stopped, or from the file list screen or the Picture CD menu screen.

2 Press the ENTER button.

- The slide show mode will change.
CUT IN/OUT: The entire image appears in one time.
FADE IN/OUT: The image appears gradually and then disappears.

3 Press the MODE button to get out from mode.

Zoom replay of JPEG, Picture CD

1 Press ZOOM button during replay.

- The screen is displayed at two magnifications with the pause state established.

2 Press the Arrow buttons (▲/▼/◀/▶) to move the indication position.

3 For zoom mode resetting, press ZOOM button to turn it OFF.

- Reset Pause to regenerate the next screen.

Notes

- JPEG, Picture CD can not be zoomed at 4 magnifications.
- If any screen zoomed at 2 magnifications in JPEG is fully displayed in the screen, the indication position can not be moved with the Arrow buttons (▲/▼/◀/▶).
- The number of movable steps is different depending on the screen size. (Maximum: 4 steps up/downward and left-/rightward)
- The zoomed screen can not be rotated for display. First rotate the screen for display, and then press ZOOM button.

4 To stop the play, press the STOP button.

PLAYING MP3 DISC / JPEG DISC / WMA / PICTURE CD IN A PROGRAMMED WAY

MP3 JPEG Picture CD WMA

- 1 Press the **MODE** button in **STOP** mode.
- The program screen shows up.

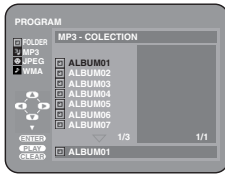

- 2 Using the **▲/▼** buttons, select a group. Then press the **ENTER** button.
- A Track selection screen appears.

- 3 Using the **▲/▼** buttons, select a track. Then press the **ENTER** button to save it in a program.
- The programmed track is displayed in the right-hand screen.
 - If the entire program cannot be displayed at once on the screen, “▼” appears to go to the next page.
 - Pressing the **◀** button will show a list of folders that belong to the one-level upper hierarchy than the currently selected folder.

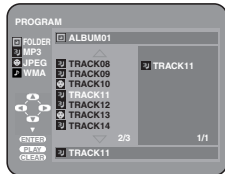

- 4 When the disc has been programmed, press the **PLAY** button.
- Programmed play starts.

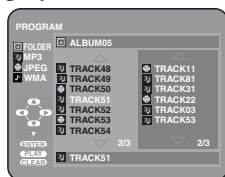

Notes

- Press the **CLEAR** button, and the last-programmed entry will be deleted.
- Press the **RETURN** button to exit the program screen. The programmed tracks will be saved, unless the power is turned off or the disc tray is opened.
- To stop programmed play, press the **STOP** button. Another press on the **STOP** button will reset the subsequent information.
- Up to 99 tracks can be set in a program.
- If a disc is inserted that contains mixed MP3, WMA and JPEG files, program setting allows 99 tracks for combination of MP3, JPEG and WMA files.
- If eight or more tracks have been set in a program, the user can switch the right part of the screen with **◀◀** or **▶▶**.

PLAYING AN MP3 DISC / JPEG DISC / WMA DISC FROM A DESIRED TRACK

MP3 JPEG WMA

- 1 Press the **MENU** button.
- The **FILE LIST** shows up.

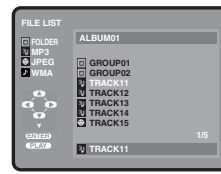

- 2 Using the **▲/▼** buttons, select a track to be played. Then press the **PLAY** or **ENTER** button to start playing.

Notes

- During play, a desired track can be directly searched. Just type in the **TRACK** number with the numeric buttons.
- If the typed **TRACK** number is not available, the “disable” symbol appears and the direct search mode is cancelled.
- Playback cannot be started from a desired time count.
- Pressing the **▶▶** or **◀◀** button will play the next or previous file.
- The **MENU** button is not effective for Picture CD playback.

PLAYING AN MP3 DISC / JPEG DISC / WMA DISC / PICTURE CD AT RANDOM

MP3 JPEG Picture CD WMA

- 1 In **STOP** mode, press the **MODE** button repeatedly until the random screen appears.

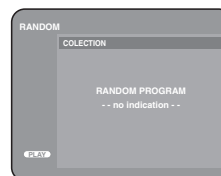

- 2 Press the **PLAY** button.

- Random play starts.
- For a disc containing mixed MP3, JPEG and WMA files, random play of those files will be performed.

SETTINGS

CHANGING THE AUDIO LANGUAGE OR SOUND MODE

DVD-A DVD-V DVD-RW CD VCD
VR-mode

This DVD player has a function which allows you to select the desired audio language and sound mode.

For DVDs

Press the AUDIO button during playback, and then press the AUDIO button to select the desired audio language.

- The audio language can be changed if multiple languages are recorded on the DVD being played.

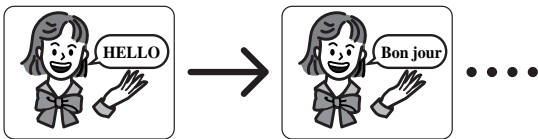
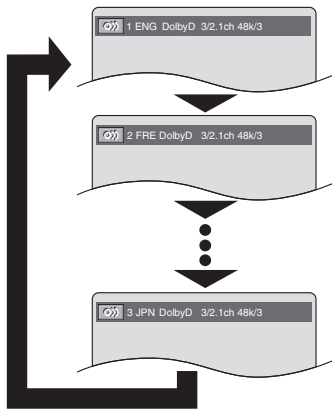

For audio CDs

Press the AUDIO button during playback.

- Pressing the AUDIO button cycles the sound mode through STEREO, L-CH and R-CH.

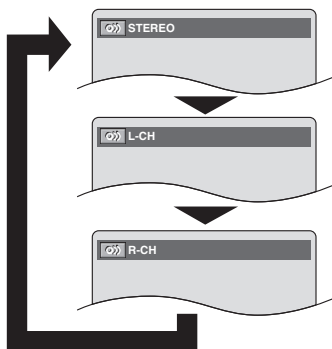

For DVD Audios

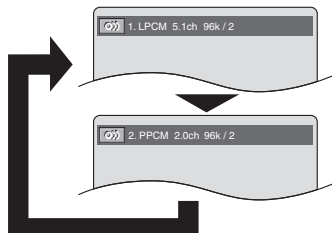

Notes

- Pressing the AUDIO button may not work on some DVDs with multiple audio languages (e.g. DVDs which allow audio language setting on the disc menu). Operation varies between discs, so refer to the manual accompanying the disc.
- Current audio language and sound mode will be displayed when you press the AUDIO button at first.
- If a desired language is not shown after pressing the AUDIO button several times, the disc does not have an audio source in that language.
- If you choose a Language that has a 3 letter language code, the code will be displayed every time you change the Audio language setting. If you choose any other languages, '---' will be displayed instead (Refer to page 30).
- The audio language resets to the one which has been selected in the setup mode, every time the power is turned on or discs are replaced. If that language is not available on a disc, a language defined by the disc is selected.
- The screen display will disappear after about 5 seconds.
- DTS CD does not allow the user to switch the sound mode.
- The selected sound number is, in case of DVD Audio, displays to number 2 normally even if there is no second sound. (The sound number during playback remains as 1.)
- The Audio language cannot be changed during Speech Control (Refer to page 28).

For Video Recording Format

For discs of DVD-RW in which sound is recorded in dual sound (bilingual) mode, the user can switch the sound mode between the main and sub sound.

Press the AUDIO button during playback.

- Pressing the AUDIO button cycles the sound mode through MAIN, SUB, MAIN+SUB.
- The user cannot switch the sound mode when playing a disc in which sound was not recorded in dual sound mode.

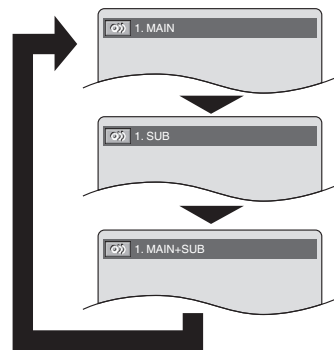

- With discs recorded in VR mode, changing the audio (MAIN, SUB or MAIN + SUB) is effective only when using an analog connection. Although you may be able to change the setting via the on-screen display, it will not affect the sound when using a digital connection.

CHANGING THE SUBTITLE LANGUAGE

DVD-A DVD-V DVD-RW
VR-mode

This DVD player has a function which allows you to select the desired language for subtitles.

1 Press the **SUBTITLE** button during playback, and then press the **SUBTITLE** button to select the desired subtitle language.

- The subtitle language can be changed if the subtitles are recorded in multiple languages on the DVD being played.
- The subtitle language cannot be changed if the subtitles are recorded in a single language on the DVD being played.

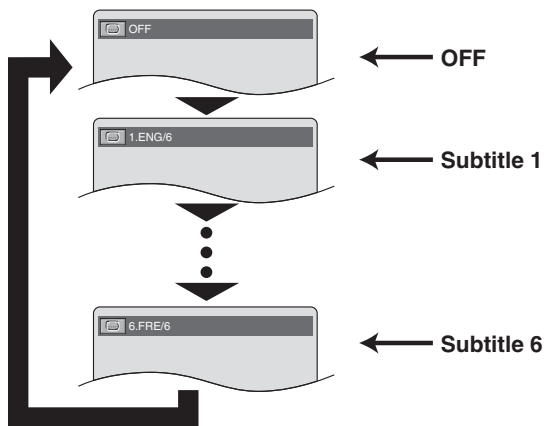

- Pressing the **SUBTITLE** button cycles the subtitle language from **SUBTITLE 1**, **SUBTITLE 2** and all the languages recorded.
- Current subtitle mode will be displayed when you press the **SUBTITLE** button at first.
- Press the **SUBTITLE** button, and then press the cursor (**◀/▶**) button to set it to on or off.

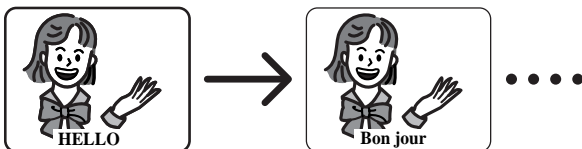

Notes

- Some discs allow subtitle language setting on the disc menu. (Operation varies between discs, so refer to the manual accompanying the disc.)
- If the desired language is not shown after pressing the **SUBTITLE** button several times, the disc does not have subtitles in that language.
- If you choose a Language that has a 3 letter language code, the code will be displayed every time you change the Subtitle language setting. If you choose any other languages, '---' will be displayed instead. (Refer to page 30.)

- The subtitle language resets to the one which has been selected in the setup mode, every time the power is turned on or discs are replaced. If that language is not available on a disc, a language defined by the disc is selected.
- It may take time to display the subtitles in the selected language.
- The screen display will disappear after about 5 seconds.
- When "NOT AVAILABLE" appears on-screen, it means no subtitle is recorded on the scene.
- For DVD-RWs recorded with subtitles, select subtitle ON or OFF.

CHANGING THE CAMERA ANGLE (Multi-Angle Pictures)

DVD-V

This DVD player has a function which allows you to select the desired camera angle.

1 Press the **ANGLE/PAGE** button during playback.

- If the disc contains sequences recorded from different camera angles, the angle icon (📷) will appear at the top-right of the screen. You can change the camera angle when the icon appears on the screen.
- The camera angle cannot be changed if the disc does not contain sequences recorded from different camera angles.

2 Press the **ANGLE/PAGE** button while the angle number is shown on the screen.

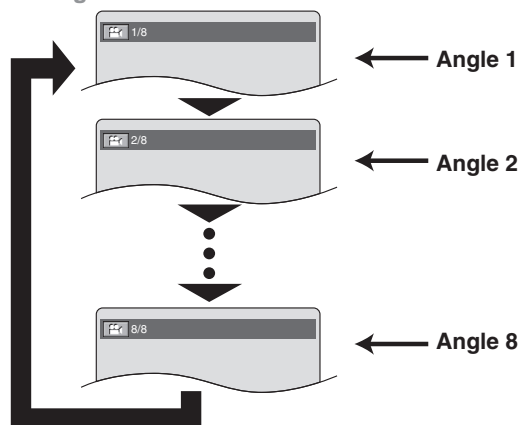

Notes

- The screen display will disappear after about 5 seconds.
- Current camera angle will be displayed when you press the **ANGLE/PAGE** button at first.
- If the "ANGLE ICON" setting is "OFF" in the Display menu, the (📷) icon will not appear.

CHANGING THE ON-SCREEN DISPLAY

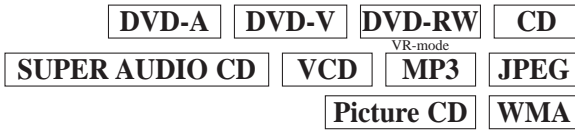

You can check the information about the disc by pressing the DISPLAY button on the remote control.

1 Press the DISPLAY button during playback.

- The information screen will appear.
- Next information screen will appear by pressing the DISPLAY button repeatedly.

For DVDs

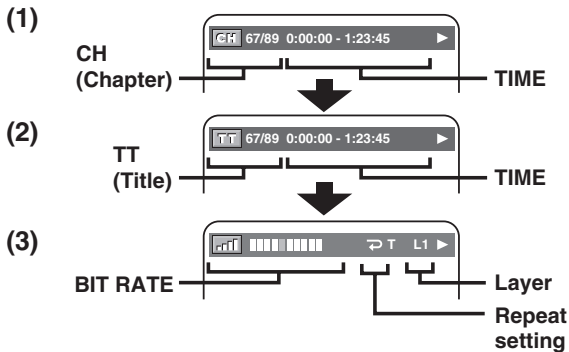

(1)	CH	Current chapter number/the number of total chapters
	TIME	Elapsed time of the current chapter and remaining time of the current chapter
(2)	TT	Current title number/the number of total titles
	TIME	Elapsed time of the current title and remaining time of the current title
(3)	BIT RATE	Shows the quantity of information which is recorded (DVD only).
	Repeat	The repeat status of the currently played item is displayed (Not displayed if repeat has not been selected) T: Title C: Chapter
	Layer	Layer number L0: Layer 0 is playing back L1: Layer 1 is playing back

Either press the RETURN button or press the DISPLAY button until the display disappears.

For Video Recording Format

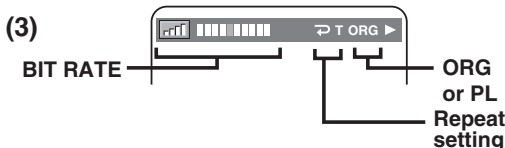

(3)	BIT RATE	Shows the quantity of information which is recorded on DVD
	Repeat	The repeat status of the currently played item is displayed (Not displayed if repeat has not been selected) T: Title; C: Chapter; A: All
	PLAY LIST	ORG: Playing the ORIGINAL PL: Playing the PLAYLIST

For audio CDs, Super Audio CD or Video CDs

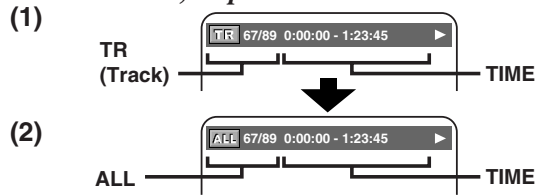

(3) Playback area of Super Audio CD (For Super Audio CD)



(4) Program/Random Playback only (For audio CD, Super Audio CD)

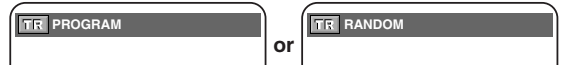

(1)	TR	Current track number/the number of total tracks
	TIME	Elapsed time of the current track and remaining time of the current track
	Repeat	The repeat status of the currently played item is displayed (Not displayed if repeat has not been selected) T: Track A: All
(2)	ALL	Current track number/the number of total tracks
	TIME	Elapsed time of the current disc and remaining time of the current disc
	Repeat	The repeat status of the currently played item is displayed (Not displayed if repeat has not been selected) T: Track A: All
(3)	MULTI-CH AREA	Playback a multi-ch area
	2CH AREA	Playback a 2ch area
	CD AREA	Playback a CD area

Either press the RETURN button or press the DISPLAY button until the display disappears.

Note

- The time is not displayed during PBC playback.

For MP3s

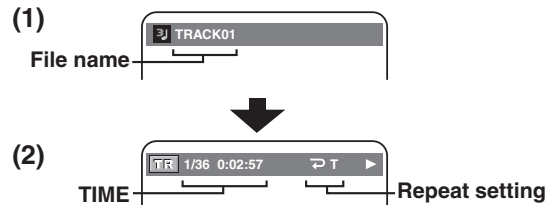

(3) Program/Random Playback only

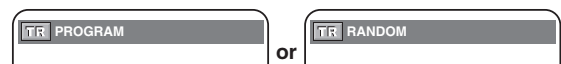

(1)	File name	Name of currently played track
(2)	TR	Current track number/the number of total tracks
	TIME	Elapsed time of the current track
	Repeat	The repeat status of the currently played item is displayed (Not displayed if repeat has not been selected) T: Track; G: Group; A: All

Either press the RETURN button or press the DISPLAY button until the display disappears.

For WMAs

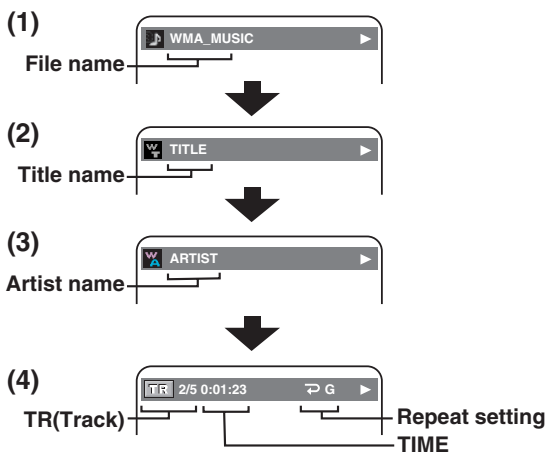

(5) Program/Random Playback only



(1) File name	Name of currently played track
(2) TITLE	Name of title of the current played track
(3) ARTIST	Name of artist of the current played track
(4) TR	Current track number/the number of total tracks
TIME	Elapsed time of the current track and remaining time of the current track
Repeat	The repeat status of the currently played item is displayed (Not displayed if repeat has not been selected) T: Track; G: Group; A: All

Either press the RETURN button or press the DISPLAY button until the display disappears.

For JPEGs or Picture CDs

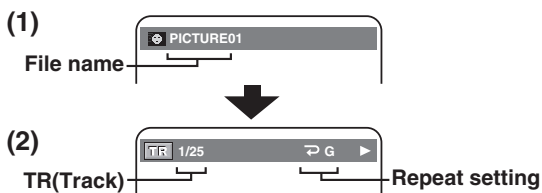

(3) Program/Random Playback only



(1) File name	Name of currently played track
(2) TR	Current track number/the number of total tracks
Repeat	The repeat status of the currently played item is displayed (Not displayed if repeat has not been selected) T: Track; G: Group (only for JPEG); A: All

Either press the RETURN button or press the DISPLAY button until the display disappears.

For DVD Audio

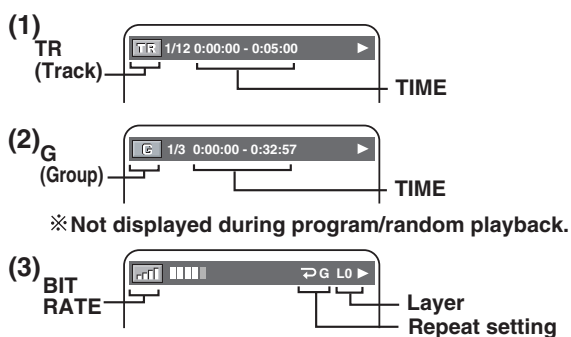

(4) Program/Random/ALL GROUP Playback only

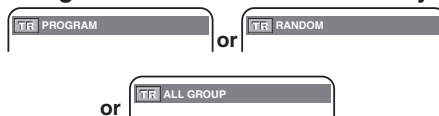

(1) TR	Current track number/the number of total tracks
TIME	Elapsed time of the current track and remaining time of the current track.
(2) G	Current group number /the number of total groups
TIME	Elapsed time of the current group and remaining time of the current group.
(3) BITRATE	Show the quality of information which is recorded in DVD Audio
Repeat	The repeat state of the currently played item is displayed (not displayed if repeat has not been selected) T: Track; G: Group; A: ALL
Layer	Layed number L0: Layer 0 is playing back L1: Layer 1 is playing back

SETTING IMAGE QUALITY ADJUSTMENT

DVD-A DVD-V DVD-RW VCD

1 Press the MODE button during playback.

- The setup screen will appear.

2 Select from items

- Every press on the MODE button switches setting screens in the following order:



- * The "Image quality setting" screen appears only when "User" has been selected in "Image quality adjustment" on the "Picture control" screen.

Picture control

Press the ◀▶ buttons to switch the setting items.

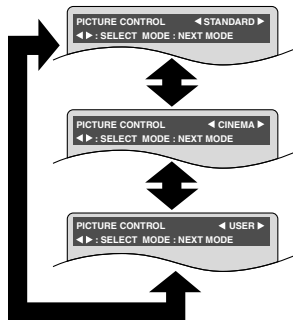

STANDARD: A standard image quality mode

CINEMA: The image quality mode for movie pictures providing easy view of dark scenes.

USER: Image quality mode that can be adjusted freely by user setting.

Image quality setting

• The “Image quality setting” screen appears only when “User” has been selected in “Image quality adjustment” on “Picture control” screen.

1. Press the ◀▶ buttons to change the value.
2. Press the ▲▼ buttons to switch items.

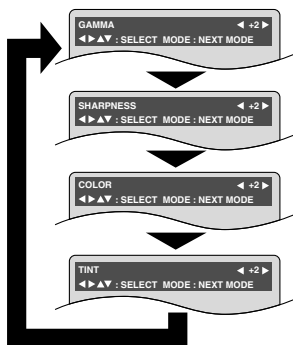

3. Press the RETURN button to save the change.

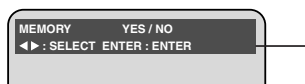

Displayed only when the value was changed.

Press the ◀▶ buttons, and select “Yes” if you want to save the change, and “No” if not, and then press the ENTER button.

Black level setting

Press the ◀▶ buttons to switch the setting items.

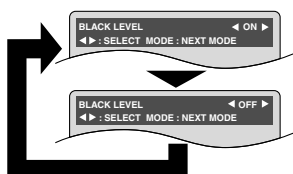

Virtual surround

• You can enjoy surround-sound effect over two speakers(only on this DVD).

Press the ◀▶ buttons to set it to 1, 2 or OFF.

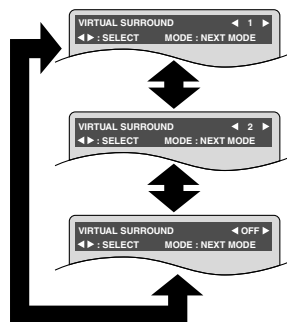

- 1: Natural effect
- 2: Emphasized effect

Notes

- The setting will be saved even if the player is turned off.
- The setting will not be effective unless the sound mode is set to STEREO. (for CD play only)
- Turn down the level or turn it “OFF” if the sound is distorted.
- This function cannot be used during Speech control.
- When Multi is selected as the audio channel in the audio setting of the setup menu, Virtual Surround does not function.
- The Virtual Surround setting is not available for Super Audio CDs. (It may be possible to use the Virtual Surround setting when playing back discs that include a CD track.)

Speech control

* Available only on discs recorded in the Dolby Digital format, Speech control plays back in slightly faster / slower speed while keeping the sound quality as in the normal playback. Press the ◀▶ buttons to switch among OFF,(x0.8) and (x1.3).

x0.8:Plays back approximately at 0.8 times of normal playback.
x1.3:Plays back approximately at 1.3 times of normal playback.
To return to normal playback, press the PLAY button.

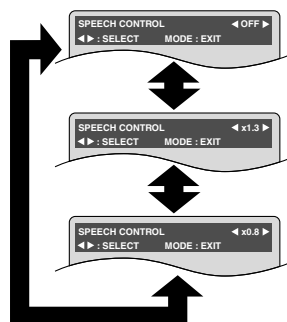

Notes

- Audio (language) setting cannot be changed while using this mode.
- Picture control, Virtual Surround and Black Level settings cannot be changed while using this mode.
- Virtual Surround does not function while using this mode.
- This feature may not work at some points on a disc.
- When using digital audio connection (COAXIAL and OPTICAL), the PCM sound will be output.

Press the MODE or RETURN button.

- This completes the setting, which then displays the normal screen.

CHANGING THE SETUP ITEMS

LANGUAGE SETTINGS

1 Press the **SETUP** button in **STOP** mode.

- The setup screen will appear.

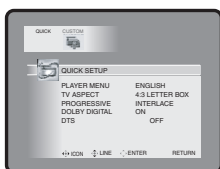

2 Press the **◀▶** buttons to select **CUSTOM**, and then press the **ENTER** button.

3 Press the **◀▶** buttons to select **Language**, and then press the **ENTER** button.

4 Press the **▲▼** buttons to select an item, and then press the **ENTER** button.

AUDIO:

(Voice is played back in selected language.)

SUBTITLE:

(Subtitles are shown in selected language.)

DISC MENU:

(The disc menu appears in selected language.)

PLAYER MENU (It can be also set by **QUICK SETUP**):
(The on-screen display appears in selected language.)

5 Press the **▲▼** buttons to select a desired item, and then press the **ENTER** button.

- If “OTHER” is selected on the **AUDIO**, **SUBTITLE** or **DISC MENU** setting screen, the Language Code setting screen will appear. Press the Numeric buttons to enter the desired language code while referring to the list on page 30.

6 Press the **SETUP** button.

- The setup mode will be cancelled and the ordinary screen will appear.

Note

- Language Setting for Audio and Subtitle is not available with some discs. Use the **AUDIO** and **SUBTITLE** buttons. Details are on pages 24 and 25.

LANGUAGE CODE LIST

Language	Country code	Language	Country code	Language	Country code
Afar	4 7 4 7	Interlingua	5 5 4 7	Quechua	6 3 6 7
Abkhazian	4 7 4 8	Interlingue	5 5 5 1	Rhaeto-Romance	6 4 5 9
Afrikaans	4 7 5 2	Inupiak	5 5 5 7	Kirundi	6 4 6 0
Amharic	4 7 5 9	Indonesian	5 5 6 0	Romanian [RUM]	6 4 6 1
Arabic	4 7 6 4	Icelandic [ICE]	5 5 6 5	Russian [RUS]	6 4 6 7
Assamese	4 7 6 5	Italian [ITA]	5 5 6 6	Kinyarwanda	6 4 6 9
Aymara	4 7 7 1	Hebrew	5 5 6 9	Sanskrit	6 5 4 7
Azerbaijani	4 7 7 2	Japanese	5 6 4 7	Sindhi	6 5 5 0
Bashkir	4 8 4 7	Yiddish	5 6 5 5	Sangho	6 5 5 3
Byelorussian	4 8 5 1	Japanese [JPN]	5 6 6 9	Serbo-Croatian	6 5 5 4
Bulgarian	4 8 5 3	Georgian	5 7 4 7	Singhalese	6 5 5 5
Bihari	4 8 5 4	Kazakh	5 7 5 7	Slovak	6 5 5 7
Bislama	4 8 5 5	Greenlandic	5 7 5 8	Slovenian	6 5 5 8
Bengali;Bangla	4 8 6 0	Cambodian	5 7 5 9	Samoa	6 5 5 9
Tibetan	4 8 6 1	Kannada	5 7 6 0	Shona	6 5 6 0
Breton	4 8 6 4	Korean [KOR]	5 7 6 1	Somali	6 5 6 1
Catalan	4 9 4 7	Kashmiri	5 7 6 5	Albanian	6 5 6 3
Corsican	4 9 6 1	Kurdish	5 7 6 7	Serbian	6 5 6 4
Czech	4 9 6 5	Kirghiz	5 7 7 1	Siswat	6 5 6 5
Welsh	4 9 7 1	Latin	5 8 4 7	Sesotho	6 5 6 6
Danish [DAN]	5 0 4 7	Lingala	5 8 6 0	Sundanese	6 5 6 7
German [GER]	5 0 5 1	Laothian	5 8 6 1	Swedish [SWE]	6 5 6 8
Bhutani	5 0 7 2	Lithuanian	5 8 6 6	Swahili	6 5 6 9
Greek [GRE]	5 1 5 8	Latvian;Lettish	5 8 6 8	Tamil	6 6 4 7
English [ENG]	5 1 6 0	Malagasy	5 9 5 3	Telugu	6 6 5 1
Esperanto	5 1 6 1	Maori	5 9 5 5	Tajik	6 6 5 3
Spanish [SPA]	5 1 6 5	Macedonian	5 9 5 7	Thai	6 6 5 4
Estonian	5 1 6 6	Malayalam	5 9 5 8	Tigrinya	6 6 5 5
Basque	5 1 6 7	Mongolian	5 9 6 0	Turkmen	6 6 5 7
Persian	5 2 4 7	Moldavian	5 9 6 1	Tagalog	6 6 5 8
Finnish [FIN]	5 2 5 5	Marathi	5 9 6 4	Setswana	6 6 6 0
Fiji	5 2 5 6	Malay	5 9 6 5	Tonga	6 6 6 1
Faroese	5 2 6 1	Maltese	5 9 6 6	Turkish [TUR]	6 6 6 4
French [FRE]	5 2 6 4	Burmese	5 9 7 1	Tsonga	6 6 6 5
Frisian	5 2 7 1	Nauru	6 0 4 7	Tatar	6 6 6 6
Irish [IRI]	5 3 4 7	Nepali	6 0 5 1	Twi	6 6 6 9
Scots Gaelic	5 3 5 0	Dutch [DUT]	6 0 5 8	Ukrainian	6 7 5 7
Galician	5 3 5 8	Norwegian [NOR]	6 0 6 1	Urdu	6 7 6 4
Guarani	5 3 6 0	Occitan	6 1 4 9	Uzbek	6 7 7 2
Gujarati	5 3 6 7	(Afan)Oromo	6 1 5 9	Vietnamese	6 8 5 5
Hausa	5 4 4 7	Oriya	6 1 6 4	Volapuk	6 8 6 1
Hindi	5 4 5 5	Panjabi	6 2 4 7	Wolof	6 9 6 1
Croatian	5 4 6 4	Polish	6 2 5 8	Xhosa	7 0 5 4
Hungarian [HUN]	5 4 6 7	Pashto;Pushto	6 2 6 5	Yoruba	7 1 6 1
Armenian	5 4 7 1	Portuguese [POR]	6 2 6 6	Chinese [CHI]	7 2 5 4
				Zulu	7 2 6 7

If you choose a Language that has a 3 letter language code, the code will be displayed every time you change the Audio or Subtitle language setting on pages 24 and 25. If you choose any other languages, '---' will be displayed instead. (3 letter language code is written in bracket.)

DISPLAY SETTINGS

1 Press the **SETUP** button in **STOP** mode.

- The setup screen will appear.



2 Press the **◀▶** buttons to select **CUSTOM**, and then press the **ENTER** button.



3 Press the **◀▶** buttons to select **DISPLAY** and then press the **ENTER** button.

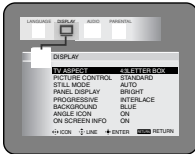

4 Press the **▲▼** buttons to select an item, and then press the **ENTER** button.

TV ASPECT (Default : 4:3 LETTER BOX)
(It can be also set by **QUICK SETUP**)

4:3 LETTER BOX: Widescreen with black bars on top and bottom

4:3 PAN & SCAN: Full height picture, trimmed both sides

16:9 WIDE : If widescreen TV is connected

16:9 NORMAL : 4:3 image will be displayed on the 16:9 screen.



PICTURE CONTROL (Default: STANDARD)

Sets the image to display, to an easy-to-see status.

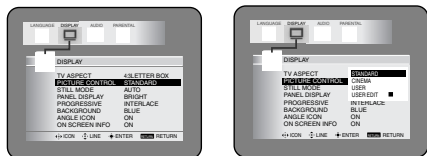

STILL MODE (Default: AUTO)

- Press **▲** or **▼** for an item selection (AUTO, FIELD, or FRAME), then press the **ENTER** button.
- This adjusts the resolution of pictures while in the still (PAUSE) mode.
- AUTO is normally selected.

- Select **FIELD** if pictures in still mode are blurred.
- Select **FRAME** to view pictures in still mode at high resolution.



PANEL DISPLAY (Default : BRIGHT)

Adjust the brightness of the unit's display.

Auto: Stays dim only during playback.



PROGRESSIVE (Default : INTERLACE)

(It can also be set by **QUICK SETUP**)

- Press **▲** or **▼** to set **PROGRESSIVE SCAN** to **PROGRESSIVE** or **INTERLACE**, then press the **ENTER** button.
- The setting will be effective when you exit the setup screen by pressing **SETUP** button.
- When **PROGRESSIVE SCAN** is **PROGRESSIVE**, "P.SCAN" appears on the DVD player's display.
- Refer to page 11 for more details.



BACKGROUND (Default: BLUE)

Select blue or gray.



ANGLE ICON (Default: ON)

Display the Angle icon on the screen.



ON SCREEN INFO (Default: ON)

Displays the playback mark, etc. on the screen.



- 5 (If you selected TV ASPECT, PICTURE CONTROL, STILL MODE, PANEL DISPLAY, PROGRESSIVE or BACKGROUND)
Press the ▲/▼ buttons to select a desired item, and then press the ENTER button.
(If you selected ANGLE ICON or ON SCREEN INFO)
Press the ENTER button.

6 Press the SETUP button.

- The setup mode will be cancelled and the ordinary screen will appear.

Note

- Selecting a different mode is only effective if it is available on the Disc.

AUDIO SETTINGS

1 Press the SETUP button in STOP mode.

- The setup screen will appear.



2 Press the ◀▶ buttons to select CUSTOM, and then press the ENTER button.



3 Press the ◀▶ buttons to select AUDIO and then press the ENTER button.

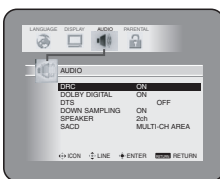

4 Press the ▲/▼ buttons to select an item, and then press the ENTER button.

DRC (Default : ON)

ON : DRC (Dynamic Range Control)

- This function is for controlling the range of sound volume. By compressing the range of sound volume, it is possible not only to suppress the output of loud sound at night and but also to raise the volume of low sound.

- This function is effective only for the sound recorded by Dolby Digital recording.

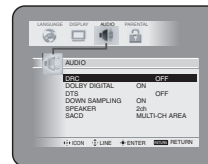

DOLBY DIGITAL (default : ON)

(It can be also set by QUICK SETUP)

ON : Output by Dolby Digital

Set to On when the unit is connected to Dolby Digital Decoder.

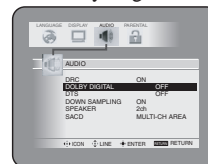
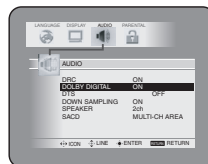

DTS (Default: OFF)

(It can be also set by QUICK SETUP)

ON : Selected when the DTS decoder is connected digitally to the amplifier installed.

OFF : Selected when the DTS decoder is connected to the amplifier incompatible to the DTS. In this case, the DTS track is not output.

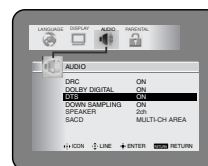
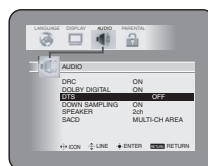

DOWN SAMPLING (Default : ON)

Set the output for the DVD recorded in PCM 96kHz (96kHz or 48kHz)

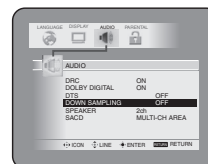

When playing a disc with copyright protection

- When playing a disc with copyright protection, the sound will be down sampled at 48kHz even if you set it to OFF.
- DOWN SAMPLING function is available only on digital output of a disc recorded in 96kHz, and when the unit is connected to another source using the digital out jack.
- DOWN SAMPLING function is available only on the discs recorded in the Dolby Digital format.

SPEAKER (Default:2ch)

This is to be set when it is connected to the 5.1 channel analog input terminal of AV amplifier.

- Press the ▲/▼ buttons to select an item, and then press the ENTER button.

2 ch: Select this when it is connected to the AUDIO OUT (L/R) terminal.

5.1 ch: Select this when it is connected to the 5.1 CH OUTPUT terminal

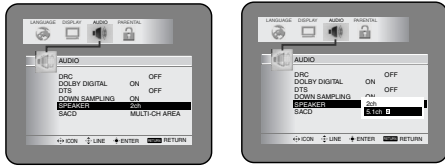

When 5.1 ch is selected

In order to attain a good surround effect, set the distance to the connected speaker.

- Press the ▲/▼ buttons to select an item, and then press the ENTER button.

SPEAKER SIZE: Set the size of the speaker to connect.

DELAY TIME: Set the delay time output from the listening position.

BALANCE: Set the output level of the connecting speaker.



SPEAKER SIZE

Select the speaker to set by pressing ▲/▼ buttons, then press the ENTER button.

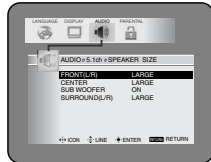

Select the size of the speaker by pressing ▲/▼ buttons, then press the ENTER button.

LARGE: Select this when the connected speaker is capable of playing back sounds of 100Hz or less.

SMALL: Select this when the connected speaker is not capable of playing back sounds of 100Hz or less.

OFF: Select this when it is not connected. (It cannot be set OFF on the FRONT speaker)

ON: Select this when SUB WOOFER is connected.



Note

- The speaker size of the FRONT speaker is determined automatically by setting the SUB WOOFER. When SUB WOOFER is not connected, it is recommended to connect a front speaker capable of playing back low tones of 100Hz or below.
- At playback of DVD Audio, the sound may not come out as set due to restrictions in the disc or the player.

DELAY TIME



Select the speaker to set by pressing ▲/▼ buttons, then press the ENTER button.

Select the delay time by pressing ▲/▼ buttons, then press the ENTER button.

CENTER	
Set value	Distance
1ms	about 34cm
2ms	about 69cm
3ms	about 103cm
4ms	about 137cm
5ms	about 172cm

SURROUND	
Set value	Distance
5ms	about 172cm
10ms	about 343cm
15ms	about 515cm



Note

- It is not possible to adjust this item if CENTER and SURROUND have been set to OFF in the SPEAKER SIZE setting.

BALANCE

When the volume level differs from each speaker, adjustment can be made in the unit of dB, from -12dB to 0 dB.

Select the speaker to set by pressing ▲/▼ buttons, then press the ENTER button

Select the volume level by pressing ▲/▼ buttons, then press the ENTER button

- TEST:** The test tone is output in clockwise from FRONT (L).

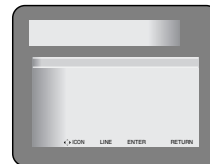

- Selecting respective speakers outputs the test tone at the volume presently set.

Notes

- When TEST is selected and the test tone is being output, balance adjustment cannot be made.
- When TEST is selected, no test tone will be output from SUBWOOFER.
- It is not possible to adjust this item for the speaker that has been set to OFF in SPEAKER SIZE setting.

5 Press the SETUP button.

- The setup mode will be cancelled and the ordinary screen will appear.

SACD (Default: MULTI-CH AREA)

MULTI-CH AREA : Playback a multi-ch area.

2CH AREA : Playback a 2ch area.

CD AREA : Playback a CD area.

- When choosing MULTI-CH AREA, choose 5.1 CH as well as the audio channel in the audio setting of the setup menu.



5 Press the SETUP button.

- The setup mode will be cancelled and the ordinary screen will appear.

PARENTAL LOCK

1 Press the SETUP button in STOP mode.

- The setup screen will appear.



2 Press the ◀▶ buttons to select CUSTOM, and then press the ENTER button.



3 Press the ◀▶ buttons to select PARENTAL, and then press the ENTER button.

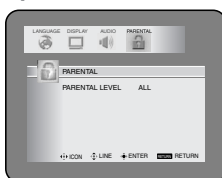

4 Press the Numeric buttons to enter the 4-digit password, and then press the ENTER button.

- When doing this for the first time, enter any 4 digits (except for 4737). This number will be used as the password from the second time onward.
- By entering the password, you can then change the control level and password settings.

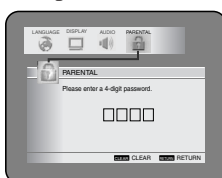

5 Press the ▲/▼ buttons to select an item, and then press the ENTER button.

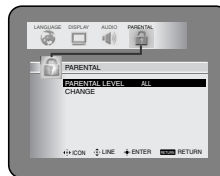

When "PARENTAL LEVEL" is selected

- Press the ▲/▼ buttons to select an item from "ALL" or 8 to 1 and then press the ENTER button.

ALL

All parental lock is cancelled.

Level 8

DVD software of any grade (adult/general/children) can be played back.

Levels 7 to 2

Only DVD software intended for general use and children can be played back.

Level 1

Only DVD software intended for children can be played back, with those intended for adult and general use prohibited.

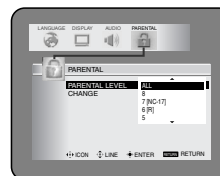

When "CHANGE" is selected

- Press the Numeric buttons to enter the 4 digits password. Then press the ENTER button.



6 Press the SETUP button.

- The setup mode will be cancelled and the ordinary screen will appear.

Notes

- With some DVDs, it may be difficult to find if they are compatible with parental lock. Be sure to check if the parental lock function operates in the way that you have set.
- Record the password in case you forget it.

IF YOU FORGET THE PASSWORD

1) Press the 4, 7, 3, 7 at step 4.

- Password will be cleared and parental level will be set to ALL.

2) Proceed the above steps 4-6 again.

TROUBLESHOOTING GUIDE

If the DVD player does not perform properly when operated as instructed in this Owner's Guide, check the player, consulting the following checklist.

Symptom	Cause	Remedy
No power	<ul style="list-style-type: none"> Loose power plug. 	<ul style="list-style-type: none"> Insert the power plug firmly into the wall outlet.
The player does not respond to the remote control.	<ul style="list-style-type: none"> The remote control is not aimed at the sensor on the player. Obstacles present between the remote control and the sensor. The remote control is too far away from the player. Dead batteries. 	<ul style="list-style-type: none"> Aim the remote control directly at the sensor on the player. Remove the obstacles from the signal path. Check room lighting. Use the remote control within 23 feet of the player. Replace the batteries.
No picture	<ul style="list-style-type: none"> Loose video connection. Wrong disc. Progressive scan is on. ("P.SCAN" lights up in the display.) 	<ul style="list-style-type: none"> Connect the video cables firmly. Insert a correct video disc that plays on this player. If your TV is not compatible with progressive scanning, set "PROGRESSIVE" to "INTERLACE".
Disc cannot be played	<ul style="list-style-type: none"> No disc. Dirty disc. Disc is placed upside down. Parental lock is active. 	<ul style="list-style-type: none"> Insert a disc. Clean the disc. Place the disc correctly, with the label side up. Cancel the parental lock or change the control level.
No sound	<ul style="list-style-type: none"> Loose audio connection. The power of the connected audio component is off. Wrong audio output settings. Wrong input settings on the connected audio component. 	<ul style="list-style-type: none"> Connect the audio cables firmly. Turn the power of the audio component on. Correct the audio output settings. Correct the input settings on the audio component.
Distorted picture	<ul style="list-style-type: none"> Copy protection is active. Immediately after playing, press fast forward or in reverse. The 1st layer is switching to the 2nd layer, when playing a two layered disc. 	<ul style="list-style-type: none"> Connect the player directly to the TV. There are some cases where pictures may be slightly distorted, which are not a sign of a malfunction. Although Pictures may stop for a moment, this is not a malfunction and is quite common.
Audio or subtitle language does not match the setup.	<ul style="list-style-type: none"> The selected language is not available for audio or subtitles on the DVD. 	<ul style="list-style-type: none"> No malfunction.
The camera angle cannot be changed.	<ul style="list-style-type: none"> The DVD does not contain sequences recorded from different camera angles. 	<ul style="list-style-type: none"> No malfunction.
Audio or subtitle language cannot be changed.	<ul style="list-style-type: none"> The DVD does not contain audio source or subtitles in the selected language. 	<ul style="list-style-type: none"> No malfunction.
"Prohibited icon" appears on the screen, prohibiting an operation.	<ul style="list-style-type: none"> That operation is prohibited by the player or disc. 	<ul style="list-style-type: none"> No malfunction.
A sound different from the value set in SETUP is output.	<ul style="list-style-type: none"> Some discs in the DVD Audio output sound different from the sound value previously set in SETUP. 	<ul style="list-style-type: none"> No malfunction.

Notes

- Some functions are not available in specific modes, but this is not a malfunction. Read the description in this Owner's Guide for details on correct operations.
- Playback from a desired track and random playback are not available during program playback.
- DOWN SAMPLING function is available only on the discs recorded in the Dolby Digital format.
- Some functions are prohibited on some discs.

HANDLING PRECAUTIONS

Servicing

Should your DVD player become inoperable, do not try to correct the problem by yourself. There are no user-serviceable parts inside. Turn the power off, unplug the power cord, and please call our help line at 1-800-332-2119 to locate an Authorized Service Center.

Cabinet Cleaning

- Wipe the front panel and other exterior surfaces of the DVD player with a soft cloth immersed in lukewarm water and wrung dry.
- Never use a solvent or alcohol. Do not spray any type of liquid near the DVD player. Certain chemicals may cause damage and discoloration to the exposed surfaces.

If the Laser Optical Pickup Unit is Dirty

- If the player still does not perform properly when it is operated and you have referred to the relevant sections and to the "Troubleshooting Guide" for help, the laser optical pickup unit may be dirty. Consult your dealer or an Authorized Service Center for inspection and cleaning of the laser optical pickup unit.

Adhesive labels

- Discs that are irregularly shaped, contain a scratch protection film or have an adhesive paper label or sticker should not be inserted into this player. Over time, the label or sticker may cause the disc to be stuck in the player, possibly causing damage to your player. If you wish to play "homemade" discs in this player, it is recommended you use a permanent felt tip marker to identify the disc.

NEVER ATTEMPT TO PLAYBACK A DISC THAT IS CRACKED OR BROKEN !

HANDLING PRECAUTIONS (continued)

Disc Handling

- Use discs which have the following logos on them.



- Handle the discs so that fingerprints and dust do not adhere to the surfaces of the discs.

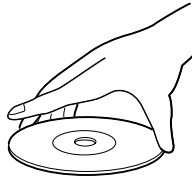
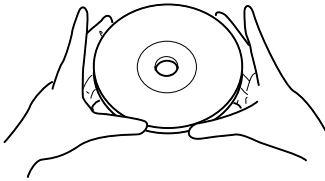

- Always store the disc in its protective case when it is not used.

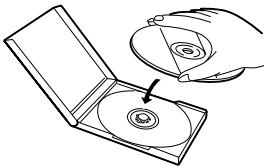

- To clean-off, use a soft cloth.
- Do not use a hard cloth since this will mar the disc.
- Wipe the disc in a straight line from center to edge.
- Never wipe in a circular motion.

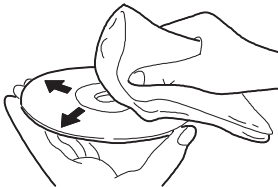

- Do not use detergent or abrasive cleansing agents.

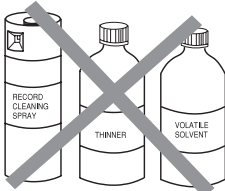

SPECIFICATIONS

Product type :	DVD Player
Discs :	DVD audio DVD video Audio CD Super Audio CD Video CD
Output signal format :	NTSC color
Frequency response :	DVD (Linear PCM) 20 Hz to 22 kHz (sample rate: 48 kHz) 20 Hz to 44 kHz (sample rate: 96 kHz) 20 Hz to 88 kHz (sample rate: 192 kHz) Super Audio CD 20 Hz to 100 kHz CD 20 Hz to 20 kHz
Signal-to-noise ratio (S/N ratio)	
CD:	120 dB (JEITA)
Dynamic range	
DVD (linear sound):	102 dB
CD:	99 dB (JEITA)
Total harmonic distortion	
DVD:	0.0025%
CD:	0.003%
Wow and flutter :	Below the measurement limitation (+/-0.001% W PEAK) (JEITA)
Connections	
S-Video output :	Mini DIN 4-pin jack (75 ohm)
Video output :	One RCA connector, 1 Vpp (75 ohm)
Coaxial digital audio output :	One pin jack, 500mVpp (75 ohm)
Analog audio output	
(2CH surround):	Two RCA connectors (one left channel, one right channel) 2Vrms (100kilo-ohm)
Analog audio output	
(5.1CH surround):	Six pin jacks, 2Vrms (100kilo-ohm)
Component video output :	One pin jack (Y), 1 Vpp (75 ohm) Two pin jacks (P _b /C _b)(P _r /C _r), 700mVpp (75 ohm)
Optical digital audio output :	Optical connector
Power source :	120 V AC +/- 10%, 60 Hz +/- 0.5%
Power consumption :	12 W (standby: <1.0W)
Operating temperature :	41°F to 104°F
Dimensions :	W 17-1/8" (435mm) H 2" (51mm) D 8-5/16" (211mm)
Weight :	1.7 kg (3.8lbs)

• Designs and specifications are subject to change without notice.

MEMO

**MITSUBISHI DVD Player
LIMITED WARRANTY**

MITSUBISHI DIGITAL ELECTRONICS AMERICA, INC. ("MDEA") warrants to the original purchaser of this DVD player if purchased from an authorized MITSUBISHI Audio/Video Dealer that, should it prove defective by reason of improper workmanship and/or material:

- a. **Parts.** For one year from the date of original purchase at retail, we will repair or replace, at our option, any defective part without charge for the part. All parts used for replacement are warranted for the remainder of the original warranty period.
 - b. **Labor.** For six months from the date of original purchase at retail, we will provide the labor for a warranty repair by an authorized MITSUBISHI service center without charge.
 - c. **Notice.** To obtain warranty service, you must notify an authorized MITSUBISHI service center of any defect within the applicable warranty time period.
1. TO OBTAIN WARRANTY SERVICE DURING THE FIRST YEAR:
- a. Contact your nearest authorized MITSUBISHI service center, whose name and address can be obtained from your MITSUBISHI dealer or by writing or calling MDEA at the address and telephone number provided below.
 - b. Warranty service will be provided at an authorized service shop, provided should a defect within the geographic area of the service center, or any other

RETAIN THIS PORTION FOR YOUR RECORDS

SERIAL NO. _____

CUSTOMER NAME _____

STREET ADDRESS _____

CITY _____ STATE _____ ZIP _____

PHONE () _____ PURCHASE DATE / /

MO DAY YR

PLACE OF PURCHASE _____