

Operating Instructions Functional Manual

DLP™ Based Projector Commercial Use

Model No. **PT-DZ110XE**
PT-DS100XE
PT-DW90XE

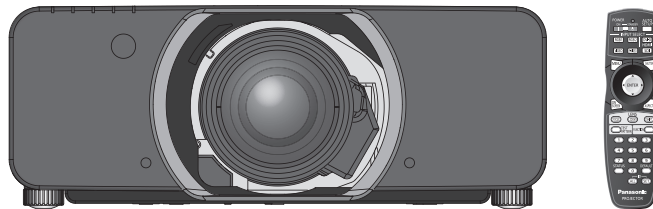

The projection lens is sold separately.

Thank you for purchasing a Panasonic Projector.

- Before operating this product, please read the instructions carefully and save this manual for future use.
- Before using your projector, be sure to read “Precautions with regard to safety” (➡ pages 9 to 17).

Important Safety Notice

Dear Panasonic Customer:

This instruction booklet provides all the necessary operating information that you might require. We hope it will help you to get the most out of your new product, and that you will be pleased with your Panasonic DLP™ Based projector. The serial number of your product may be found on its bottom. You should note it in the space provided below and retain this booklet in case service is required.

Model number: PT-DZ110XE/PT-DS100XE/PT-DW90XE

Serial number:

WARNING: THIS APPARATUS MUST BE EARTHED.

WARNING: To prevent damage which may result in fire or shock hazard, do not expose this appliance to rain or moisture.

Machine Noise Information Ordinance 3. GSGV, January 18, 1991: The sound pressure level at the operator position is equal or less than 70 dB (A) according to ISO 7779.

WARNING:

1. Remove the plug from the mains socket when this unit is not in use for a prolonged period of time.
2. To prevent electric shock, do not remove cover. No user serviceable parts inside. Refer servicing to qualified service personnel.
3. Do not remove the earthing pin on the mains plug. This apparatus is equipped with a three prong earthing-type mains plug. This plug will only fit an earthing-type mains socket. This is a safety feature. If you are unable to insert the plug into the mains socket, contact an electrician. Do not defeat the purpose of the earthing plug.

CAUTION: To assure continued compliance, follow the attached installation instructions, which includes using the provided power cord and shielded interface cables when connecting to computer or peripheral device. If you use serial port to connect PC for external control of projector, you must use optional RS-232C serial interface cable with ferrite core. Any unauthorized changes or modifications to this equipment will void the user's authority to operate.

Pursuant to at the directive 2004/108/EC, article 9(2)
Panasonic Testing Centre
Panasonic Service Europe, a division of Panasonic Marketing Europe GmbH
Winsbergring 15, 22525 Hamburg, F.R. Germany



Information for Users on Collection and Disposal of Old Equipment and used Batteries

These symbols on the products, packaging, and/or accompanying documents mean that used electrical and electronic products and batteries should not be mixed with general household waste. For proper treatment, recovery and recycling of old products and used batteries, please take them to applicable collection points, in accordance with your national legislation and the Directives 2002/96/EC and 2006/66/EC.

By disposing of these products and batteries correctly, you will help to save valuable resources and prevent any potential negative effects on human health and the environment which could otherwise arise from inappropriate waste handling.

For more information about collection and recycling of old products and batteries, please contact your local municipality, your waste disposal service or the point of sale where you purchased the items. Penalties may be applicable for incorrect disposal of this waste, in accordance with national legislation.



For business users in the European Union

If you wish to discard electrical and electronic equipment, please contact your dealer or supplier for further information.



Cd

Information on Disposal in other Countries outside the European Union

These symbols are only valid in the European Union. If you wish to discard these items, please contact your local authorities or dealer and ask for the correct method of disposal.

Note for the battery symbol (bottom two symbol examples):

This symbol might be used in combination with a chemical symbol. In this case it complies with the requirement set by the Directive for the chemical involved.



Environment care information for users in China

This symbol is only valid in China.

Important Safety Notice

IMPORTANT: THE MOULDED PLUG (U.K. only)

FOR YOUR SAFETY, PLEASE READ THE FOLLOWING TEXT CAREFULLY.

This appliance is supplied with a moulded three pin power plug for your safety and convenience. A 13 amp fuse is fitted in this plug. Should the fuse need to be replaced, please ensure that the replacement fuse has a rating of 13 amps and that it is approved by ASTA or BSI to BS1362.

Check for the ASTA mark  or the BSI mark  on the body of the fuse.

If the plug contains a removable fuse cover, you must ensure that it is refitted when the fuse is replaced. If you lose the fuse cover, the plug must not be used until a replacement cover is obtained. A replacement fuse cover can be purchased from an Authorized Service Center.

If the fitted moulded plug is unsuitable for the wall outlet in your home, then the fuse should be removed and the plug cut off and disposed of safely. There is a danger of severe electrical shock if the cut off plug is inserted into any 13 amp socket.

If a new plug is to be fitted, please observe the wiring code as shown below.
If in any doubt, please consult a qualified electrician.

WARNING: THIS APPLIANCE MUST BE EARTHED.

IMPORTANT: The wires in this power cord are colored in accordance with the following code:

Green - and - Yellow:	Earth
Blue:	Neutral
Brown:	Live

As the colors of the wire in the power cord of this appliance may not correspond with the colored markings identifying the terminals in your plug, proceed as follows.

The wire which is colored GREEN - AND - YELLOW must be connected to the terminal in the plug which is marked with the letter E or by the Earth symbol  or colored GREEN or GREEN - AND - YELLOW.

The wire which is colored BLUE must be connected to the terminal in the plug which is marked with the letter N or colored BLACK.

The wire which is colored BROWN must be connected to the terminal in the plug which is marked with the letter L or colored RED.

How to replace the fuse: Open the fuse compartment with a screwdriver and replace the fuse.

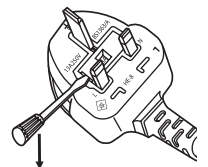

Reduced in size

While the luminance is the same as the former model, the size is reduced to about 1/2.

Volume Approx. 120 liters : PT-D10000E



Volume Approx. 60 liters : PT-DZ110XE

Lengthened lamp replacement cycle

The lamp replacement cycle is longer than the existing model. (➡page 111)

Approx. 2 000 hours : PT-D10000E
(When four lamps are used)



Approx. 3 000 hours : PT-DZ110XE
(two lamps LAMP POWER : [HIGH])

Reduced standby power

The standby power is much less than the existing model.

Approx. 25 W : PT-D10000E



Approx. 0.3 W : PT-DZ110XE
(STANDBY MODE : [ECO])

Quick steps

For details, see the corresponding pages.

1. **Set up your projector.**
(➡page 22)



2. **Attach the projection lens.**
(➡page 38)



3. **Connect with other devices.**
(➡page 35)



4. **Connect the power cord.**
(➡page 39)



5. **Start projecting.**
(➡page 40)



6. **Select the input signal.**
(➡page 42)



7. **Adjust the image.**
(➡page 42)

Important
Information

Preparation

Getting Started

Basic Operation

Settings

Maintenance

Appendix

Contents

Be sure to read "Precautions with regard to safety". (➔ pages 9 to 17)

Important Information

Important Safety Notice	2
Precautions with regard to safety	9
WARNING	9
CAUTION	12
Cautions when transporting	12
Cautions when installing	13
Security	15
Cautions on use	15
Cleaning and maintenance	16
Disposal	16
Accessories	17

Preparation

About Your Projector	18
Remote control	18
Projector body	19
Setting projector ID number to remote control	21
Using a wired remote control	21

Getting Started

Setting up	22
Projection method	22
Screen size and throw distance	23
Front leg adjusters and throwing angle	34
Connections	35
Before connection to the projector	35
Connecting example : AV equipment	36
Connecting example : Computers	37
Removing/attaching the projection lens (optional)	38
How to install the projection lens	38
How to remove the projection lens	38

Basic Operation

Powering ON/OFF	39
Connecting the power cord	39
Powering up the projector	40

Making adjustment and selection	40
Powering off the projector	41
Direct power off function	41

Projecting	42
Selecting the input signal	42
How to adjust the focus, zoom and shift	42
Adjustment range after lens position (optical shift)	43
Moving the projection lens position to the home position	44
Lens adjustment to compensate for uneven screen focus	44

Basic operations using the remote control	47
Using the SHUTTER function	47
On-screen display function	47
Switching the input signal	47
STATUS function	47
Automatic adjustment	48
Using the FUNCTION button	48
Displaying the internal test pattern	48
Changing the picture aspect ratio	49

Settings

Menu Navigation	50
Navigating through the menu	50
MAIN MENU	51
SUB MENU	51
PICTURE menu	53
PICTURE MODE	53
CONTRAST	54
BRIGHTNESS	54
COLOR	54
TINT	54
COLOR TEMPERATURE	55
GAMMA	56
SYSTEM DAYLIGHT VIEW	56
SHARPNESS	57
NOISE REDUCTION	57
DYNAMIC IRIS	57
SYSTEM SELECTOR	58

To display pictures complying with the sRGB standard	58	LAMP RELAY	77
POSITION menu	59	LAMP POWER	78
SHIFT	59	BRIGHTNESS CONTROL	78
ASPECT	59	STANDBY MODE	82
ZOOM	60	SCHEDULE	82
CLOCK PHASE	61	RS-232C	83
GEOMETRY (PT-DZ110/PT-DS100 only)	61	STATUS	84
KEystone (PT-DW90 only)	63	NO SIGNAL SHUT-OFF	85
ADVANCED MENU	64	REMOTE2 MODE	85
DIGITAL CINEMA REALITY	64	FUNCTION BUTTON	85
BLANKING	64	DATE AND TIME	85
INPUT RESOLUTION	65	LENS CALIBRATION	86
CLAMP POSITION	65	FILTER COUNTER RESET	86
EDGE BLENDING	65	SAVE ALL USER DATA	87
FRAME DELAY	67	LOAD ALL USER DATA	87
RASTER POSITION	67	INITIALIZE	87
DISPLAY LANGUAGE menu	68	SERVICE PASSWORD	87
Changing the display language	68	P IN P menu	88
DISPLAY OPTION menu	69	Using the P IN P function	88
COLOR MATCHING	69	Setting the P IN P function	88
LARGE SCREEN CORRECTION	70	TEST PATTERN menu	89
SCREEN SETTING (PT-DZ110/PT-DS100 only)	70	TEST PATTERN	89
WAVEFORM MONITOR (PT-DZ110 only)	71	SIGNAL LIST menu	90
AUTO SIGNAL	72	Registering a signal to the list	90
AUTO SETUP	72	Renaming a registered data	90
RGB IN (Only RGB input)	73	Deleting a registered data	90
DVI-D IN	73	Managing the sub memory list	91
HDMI IN	74	SECURITY menu	92
SDI IN (PT-DZ110/PT-DS100 only)	74	SECURITY PASSWORD	92
ON-SCREEN DISPLAY	74	SECURITY PASSWORD CHANGE	92
BACK COLOR	75	DISPLAY SETTING	93
STARTUP LOGO	75	TEXT CHANGE	93
FREEZE	75	MENU LOCK	93
PROJECTOR SETUP menu	76	MENU LOCK PASSWORD	93
PROJECTOR ID	76	CONTROL DEVICE SETUP	94
INSTALLATION	76	NETWORK menu	95
HIGH ALTITUDE MODE	76	NETWORK SETUP	95
COOLING CONDITION	77	NETWORK CONTROL	95
LAMP SELECT	77	NETWORK STATUS	95
		Network connections	96

Contents

Accessing from the Web browser97

Maintenance

Monitor Lamp indicators..... 108

Managing the indicated problems 108

Replacement110

Before replacing the unit 110

Replacing the unit 110

Troubleshooting113

Appendix

Technical Information115

PJLink protocol 115

Control commands via LAN 116

Serial terminal 118

REMOTE 2 IN terminal 121

Two window display combination list 122

Restoring the MENU LOCK PASSWORD
to default..... 122

List of compatible signals..... 123

Specifications 125

Dimensions 127

About brand 127

Ceiling mount bracket safeguards..... 128

Attachment procedure..... 128

Index 129

Important
Information

Preparation

Getting Started

Basic Operation

Settings

Maintenance

Appendix

Precautions with regard to safety

WARNING

■ POWER

The wall outlet or the circuit breaker shall be installed near the equipment and shall be easily accessible when problems occur. If the following problems occur, cut off the power supply immediately.

Continued use of the projector in these conditions will result in fire or electric shock.

- If foreign objects or water get inside the projector, cut off the power supply.
- If the projector is dropped or the cabinet is broken, cut off the power supply.
- If you notice smoke, strange smells or noise coming from the projector, cut off the power supply.

Please contact an Authorized Service Center for repairs, and do not attempt to repair the projector yourself.

During a thunderstorm, do not touch the projector or the cable.

Electric shocks can result.

Do not do anything that might damage the power cord or the power plug.

If the power cord is used while damaged, electric shocks, short-circuits or fire will result.

- Do not damage the power cord, make any modifications to it, place it near any hot objects, bend it excessively, twist it, pull it, place heavy objects on top of it or wrap it into a bundle.

Ask an Authorized Service Center to carry out any repairs to the power cord that might be necessary.

Insert the power plug securely into the wall outlet.

If the plug is not inserted correctly, electric shocks or overheating will result.

- Do not use anything other than the provided power cord.
- Do not use the provided power cord for other electrical equipment.
- Do not use plugs which are damaged or wall outlets which are coming loose from the wall.

Clean the power plug regularly to prevent it from becoming covered in dust.

Failure to observe this will cause a fire.

- If dust builds up on the power plug, the resulting humidity can damage the insulation.
- If not using the projector for an extended period of time, pull the power plug out from the wall outlet.

Pull the power plug out from the wall outlet and wipe it with a dry cloth regularly.

Do not handle the power plug with wet hands.

Failure to observe this will result in electric shocks.

Do not overload the wall outlet.

If the power supply is overloaded (ex., by using too many adapters), overheating may occur and fire will result.

■ ON USE/INSTALLATION

Do not place liquid containers on top of the projector.

If water spills onto the projector or gets inside it, fire or electric shocks will result.

If any water gets inside the projector, contact an Authorized Service Center.

Do not place the projector on soft materials such as carpets or sponge mats.

Doing so will cause the projector to overheat, which can cause burns, fire or damage to the projector.

Do not set up the projector in humid or dusty places or in places where the projector may come into contact with oily smoke or steam, ex. a bathroom.

Using the projector under such conditions will result in fire, electric shocks or components deterioration.

Components deterioration (such as ceiling mount brackets) may cause the projector which is mounted on the ceiling to fall down.

Do not install this projector in a place which is not strong enough to take the full weight of the projector or on top of a surface which is sloped or unstable.

Failure to observe this will cause projector to fall down or tip over the projector, and severe injury or damage could result.

Precautions with regard to safety

Do not place another projector or other heavy objects on top of the projector.

Failure to observe this will cause the projector to become unbalanced and fall, which could result in damage or injury. The projector will be damaged or deformed.

Installation work (such as ceiling suspension) should only be carried out by a qualified technician.

If installation is not carried out and secured correctly it can cause injury or accidents, such as electric shocks.

- Do not use anything other than an authorized ceiling mount bracket.
- Be sure to use the provided accessory wire with an eye bolt as an extra safety measure to prevent the projector from falling down. (Install in a different location to the ceiling mount bracket)

Do not cover the air inlet port or the air outlet port.

Doing so will cause the projector to overheat, which can cause fire or damage to the projector.

- Do not place the projector in narrow, badly ventilated places such as closets or bookshelves.
- Do not place the projector on cloth or papers, as these materials could be drawn into the air inlet port.

Do not place your hands or other objects close to the air outlet port.

Doing so will cause burns or damage your hands or other objects.

- Heated air comes out of the air outlet port. Do not place your hands or face, or objects which cannot withstand heat close to this port.

Do not look and place your skin into the lights emitted from the lens while the projector is being used.

Doing so can cause burns or loss of sight.

- Strong light is emitted from the projector's lens. Do not look or place your hands directly into this light.
- Be especially careful not to let young children look into the lens. In addition, turn off the power and disconnect the power plug when you are away from the projector.

Do not insert any foreign objects into the projector.

Doing so will cause fire or electric shocks.

- Do not insert any metal objects or flammable objects into the projector or drop them onto the projector.

Never attempt to remodel or disassemble the projector.

High voltages can cause fire or electric shocks.

- For any inspection, adjustment and repair work, please contact an Authorized Service Center.

Do not project an image with the lens cover attached.

Doing so can cause fire.

When replacing the lamp, do not touch the fan with your finger or another part of your body.

If you do so, you may get hurt.

■ ACCESSORIES

Do not use or handle the batteries improperly, and refer to the following.

Failure to observe this will cause burns, batteries to leak, overheat, explode or catch fire.

- Do not use unspecified batteries.
- Use manganese batteries but not rechargeable batteries.
- Do not disassemble dry cell batteries.
- Do not heat the batteries or place them into water or fire.
- Do not allow the + and – terminals of the batteries to come into contact with metallic objects such as necklaces or hairpins.
- Do not store batteries together with metallic objects.
- Store the batteries in a plastic bag and keep them away from metallic objects.
- Make sure the polarities (+ and –) are correct when inserting the batteries.
- Do not use a new battery together with an old battery or mix different types of batteries.
- Do not use batteries with the outer cover peeling away or removed.
- Remove the empty batteries from the remote control at once.
- Insulate the battery using tape or something similar before disposal.

Do not allow children to reach the AA/R6 batteries.

- The battery can cause personal injury if swallowed.
- If swallowed, seek medical advice immediately.

If the battery fluid leaks, do not touch it with bare hands, and take the following measures if necessary.

- Battery fluid on your skin or clothing could result in skin inflammation or injury.
Rinse with clean water and seek medical advice immediately.
- Battery fluid coming in contact with your eyes could result in loss of sight.
In this case, do not rub your eyes. Rinse with clean water and seek medical advice immediately.

Do not disassemble the lamp unit.

If the lamp breaks, it could cause injury.

Lamp replacement

The lamp has high internal pressure. If improperly handled, an explosion and severe injury or accidents will result.

- Replacement of the lamp should be carried out by a qualified technician.
- The lamp can easily explode if struck against hard objects or dropped.
- Before replacing the lamp, be sure to disconnect the power plug from the wall outlet.
Electric shocks or explosions can result if this is not done.
- When replacing the lamp, allow it to cool for at least one hour before handling it otherwise it can cause burns.

Do not allow infants or pets to touch the remote control unit.

- Keep the remote control unit out of the reach of infants and pets after using it.

Keep the attached screws and plain washers away from babies and infants.

- If a baby swallows a screw by accident, it may be affected badly.
- If a baby seems to have swallowed a screw, consult the doctor immediately.

Precautions with regard to safety

CAUTION

■ POWER

When disconnecting the power cord, be sure to hold the power plug and power connector.
If the power cord itself is pulled, the lead will become damaged, and fire, short-circuits or serious electric shocks will result.

When not using the projector for an extended period of time, disconnect the power plug from the wall outlet and remove the batteries from the remote control.

Disconnect the power plug from the wall outlet before carrying out any cleaning.
Electric shocks can result if this is not done.

■ ON USE/INSTALLATION

Do not put your weight on this projector.

You could fall or the projector could break, and injury will result.

- Be especially careful not to let young children stand or sit on the projector.

Do not place the projector in extremely hot locations.

Doing so will cause the outer casing or internal components to deteriorate, or result in fire.

- Take particular care in locations exposed to direct sunlight or near stoves.

Always disconnect all cables before moving the projector.

Moving the projector with cables still attached can damage the cables, which will cause fire or electric shocks to occur.

Do not place your hands in the openings beside the optical lens, while shifting the lens.

Failure to observe this could cause injury.

■ ACCESSORIES

Do not use the old lamp unit.

If used it could cause lamp explosion.

If the lamp has broken, ventilate the room immediately. Do not touch or bring your face close to the broken pieces.

Failure to observe this will cause the user to absorb the gas which was released when the lamp broke and which contains nearly the same amount of mercury as fluorescent lamps, and the broken pieces will cause injury.

- If you believe that you have absorbed the gas or that the gas has got into your eyes or mouth, seek medical advice immediately.
- Ask your dealer about replacing the lamp unit and check the inside of the projector.

Cautions when transporting

When transporting the projector or carrying it around, make sure that the lens cover is always in place, and remove the lens. Please take care to keep them away from vibration and impacts, both the projector and the lens are precision-made and easily susceptible to damage.

When transporting the projector, the leg adjusters must be housed and do not hold them. Please securely hold only its bottom and none of its other parts or surfaces as this will result in malfunctions.

Cautions when installing

■ After removing the projection lens, install the dust sponge attached to the projector.

If the dust sponge is not installed, dust will be accumulated inside and can cause a trouble.

■ Do not use under the following conditions.

● Do not set up the projector outdoors.

The projector is designed for indoor use only.

● Avoid setting up in places which are subject to vibration or shocks.

If the projector is installed in a place where vibrations are transmitted or mounted in a car or a vessel, vibrations or impacts will result in damage to the internal parts, causing failure. Install the product in a place free from vibrations and impacts.

● Avoid setting up in places which are subject to sudden temperature changes, such as near an air conditioner or lighting equipment.

Failure to observe this will result in malfunctions or the lamp life will be shortened.

See “■ TEMP indicator” on page 109.

● Avoid setting up in places which are near high-voltage power lines or near motors.

The product will be exposed to interference if it is installed in the vicinity of high-voltage electrical power lines or power sources.

● Do not install the projector at elevations higher than 2 700 m (8 858 ft) above sea level.

If using this projector at high elevations 1 400 - 2 700 m (4 593 - 8 858 ft) above sea level, set [HIGH ALTITUDE MODE] to [ON].

If using this projector at elevations lower than 1 400 m (4 593 ft) above sea level, set [HIGH ALTITUDE MODE] to [OFF].

Failure to observe this will result in malfunctions or the lamp life or life of other components will be shortened.

● When installing and using the projector at an angle that exceeds 30° vertically, set [COOLING CONDITION].

Failure to observe this will result in malfunctions or the lamp life or other components will be shortened.

■ Lens Focus

Do not adjust the lens focus in the initial period after switching the projector on. The high clarity projector lens is thermally affected by the light from the light source, making the focus unstable in the period just after switching on. Please allow a warm-up time of at least 30 minutes before adjusting the lens focus.

■ Be sure to ask a specialized technician when installing the product to a ceiling.

If the product is to be installed hanging from the ceiling, purchase an optional Ceiling Mount Attachment (For high ceilings: Model No. ET-PKD310H, For low ceilings: Model No. ET-PKD310S). Please call a specialized technician or contact an Authorized Service Center for installation.

Precautions with regard to safety

■ Cautions when setting the projectors 1

- When installing and using the projector with a method other than floor standing installing using adjustable feet, fix it with the 5 ceiling mounting screws (shown in the figure).
(Screw diameter: M6, Tapping depth inside set: 8 mm)
- Make a clearance of at least 5 mm between the projector bottom and setting surface by inserting spacers (metallic) etc. between them.
- The adjustable feet can be removed if they are not necessary for installation. However, do not use the screw holes for them to fix the projector.
Do not tighten other screws etc. into the screw holes for the adjustable feet.
Doing so can break the set.
When installing the removed adjustable feet again, note that the front and rear ones have different lengths.
(The longer screws are used for front feet. Length of front leg screw: 65 mm, Length of rear leg screw: 23 mm)
- When installing the projector with a method other than floor standing installing, do not adjust its angle with the adjustable feet. Doing so can break the set.

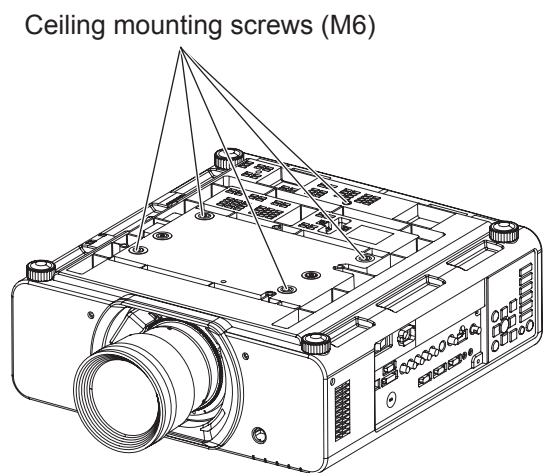
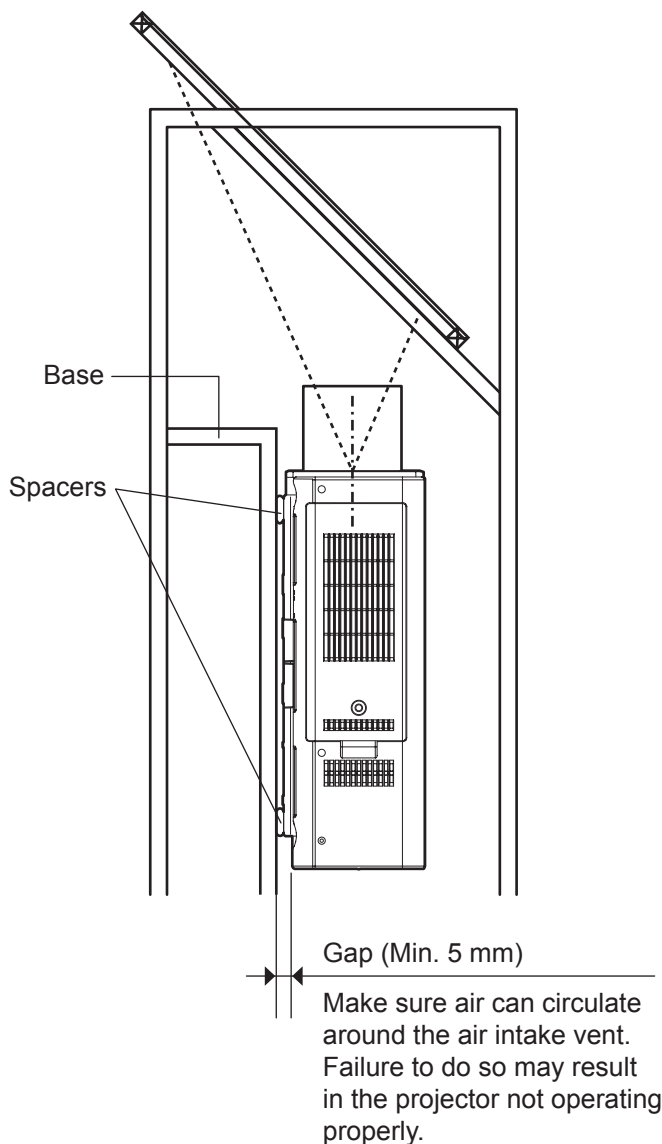

Precautions with regard to safety

■ Cautions when setting the projectors 2

- When placing the projector in confined space, a ventilation or air conditioning system must be equipped, and keep enough ventilation space on the rear and both sides of the projector.

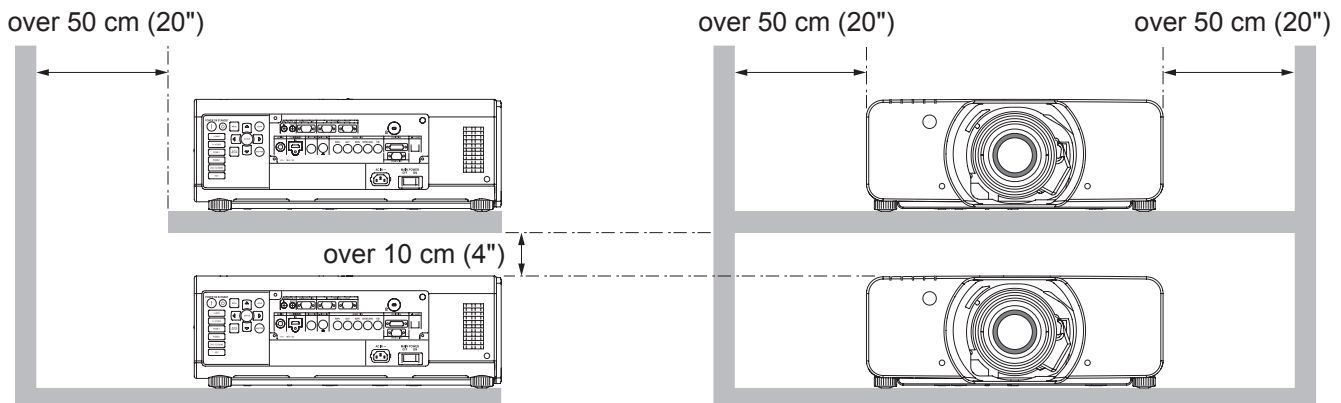

- Make a clearance of at least 5 mm between the projector bottom and setting surface by inserting spacers (metallic) etc. between them.
- Do not stack the projectors without using frame or shelf.
- Do not cover the ventilation openings or place anything within 50 cm (20") of them as this may cause damage or injury.
- Avoid heating or cooling air of the air conditioning systems directly blow on to the projector ventilation openings.
- You can tilt the projector within ± 15 degrees horizontally.

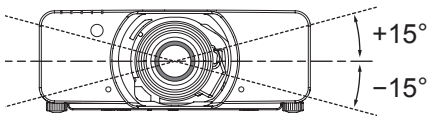
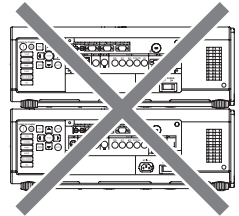

Security

■ Take safety measures against following incidents.

- Personal information being leaked via this product.
- Unauthorized operation of this product by a malicious third party.
- Interfering or stopping of this product by a malicious third party.

■ Security instruction

- The connecting network must be secured by firewall or others.
- Change your password regularly.
- Do not use a password that is simple to guess.
- Panasonic and its affiliate companies would never directly inquire about your password.
- Do not share your password with the general public.
- Set a password, and place restrictions on the users who can log in.

Cautions on use

■ In order to get the picture quality

- Draw curtains or blinds over windows and turn off any lights near the screen to prevent outside light or light from indoor lamps from shining onto the screen.
- Depending on where the projector is used, air exhaust vents or the warm air from air conditioning can cause a shimmering effect on the screen. For this reason, take care not to shield the air exhaust vents and consider the direction of the air flowing from air conditioning.

Precautions with regard to safety

■ Do not touch the surface of the projector lens with your bare hand.

If the surface of the lens becomes dirty from fingerprints or anything else, this will be magnified and projected onto the screen. Please put the lens cover on the projector when you do not use it.

■ Do not move the projector while it is operating or subject it to vibration or impact.

The service life of its internal components will be shortened.

■ The projector has a high pressure mercury lamp that is characterized as follows:

- The brightness of the lamp will decrease over time.
- The lamp may explode or shorten the lamp life by shocks or chipping damage.
- In rare cases, it may burst shortly after the first use.
- The possibility of its bursting increases when the lamp is used beyond the replacement time.
- If the lamp bursts, gas inside the lamp is released in the form of smoke.
- The life of a mercury lamp varies according to the individual difference or conditions of use.
- In particular, turning the power on and off frequently and/or repeatedly as well as continuous use for 22 hours will greatly affect the life cycle. Provide a lamp for replacement in advance.
- Lamp deterioration accelerates when used continuously for 22 hours or more. Lamp deterioration due to continuous use can be reduced by using the "LAMP RELAY" function.

■ Connection to external device

When connecting the projector to a computer or external device, use the power cord supplied with the corresponding device and a commercially available shielded interface cable.

■ Optical components

It may be necessary to replace the optical components such as DLP chips and Polarizing plates in less than 1 year if using the projector in a high temperature environment or in a very dusty, oily smoke or tobacco smoke environment. For more details, please contact your dealer.

■ DLP chips

The DLP chips are precision-made. Note that in rare cases, pixels of high precision could be missing or always lit, but this is not a malfunction. Please take note that directing a laser beam onto the lens surface can damage the DMD element.

Cleaning and maintenance

■ Ask an Authorized Service Center to clean the inside of the projector at least once a year.

If dust is left to build up inside the projector without being cleaned out, it can result in fire or problems with operation. It is a good idea to clean the inside of the projector before the season when humid weather arrives. Ask your nearest Authorized Service Center to clean the projector when required.

Please discuss with the Authorized Service Center regarding cleaning costs.

- **Be sure to remove the power plug from the wall outlet before cleaning.**
- **Use soft and dry cloth to clean the cabinet.**
Use a soft cloth moistened in warm water to clean away oil. Do not use solvents such as benzene, thinner, and alcohol, detergents for kitchens, or a chemical cloth. If using such solvents, the outer case will become deformed, and the paint may peel off.
- **Do not clean the lens surface with fuzzy or dusty cloths.**
If dust adheres to the lens, it will be magnified and projected on the screen. Use a soft and clean cloth to wipe off dust.



Disposal

When discarding this product, please contact your local authorities or dealer and ask for the correct method of disposal.

Precautions with regard to safety

Accessories

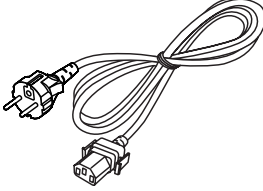
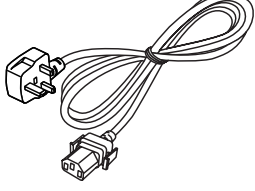
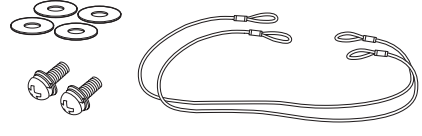
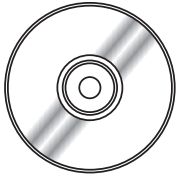
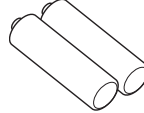
Make sure the following accessories are provided with your projector.

Remote control (x1) (N2QAYB000550)	Power cord (x1) (TXFSX01RGRZ)	Power cord (x1) (TXFSX02RGRZ)	Drop-prevention bracket (x2) (TTRA0238)
			 (Safety cables (x2) Washers (x4) Wire rope fixing screw (x2))
	CD-ROM (x1) (TXFQB02VKN)	AA/R6 batteries for remote control (x2)	Lens fixing screw (x1) (XYN4+J18FJ)
			

Attention

- After unpacking the projector, discard the power cord cap and packaging material properly.
- For lost accessories, consult your dealer.
- The part numbers of accessories and separately sold components are subject to change without notice.
- Store small parts in an appropriate manner, and keep them away from young children.

About Your Projector

Remote control

Top view

Remote control signal emitters

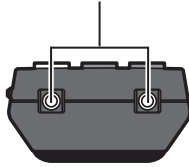

Bottom view

Remote control wired terminal
(➔ page 21)

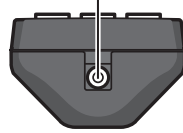

Installing/removing batteries

Press the tab and lift up the cover.

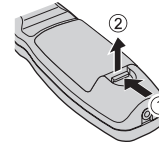

Insert the batteries according to the polarity diagram indicated inside. (insert the  side first).

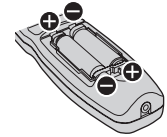

Remove the batteries in the reverse order to setting.

Front view

Remote control indicator

Flashes by pressing any buttons.





Starts the projection while in the standby mode.

These buttons select the RGB1, RGB2, DVI-D, VIDEO, S-VIDEO and SDI terminals. (➔ page 47)

<MENU> button

Displays and clears the main menu, and returns to the previous menu when the menu is displayed.

Navigation and <ENTER> buttons

Navigate through the menu items with    , and activate them with the <ENTER> button. (➔ page 50)

Displays and clears the on screen indications. (➔ page 47)

Displays the test pattern. (➔ page 48)

Enter ID number of the remote control and adjustment values of menu items.

Displays projector information.





Makes the remote control available to control any ID projectors. (➔ page 21)

Returns to the standby mode.

Pressing this button while projecting an image automatically corrects the picture positioning on the screen. While the auto setup feature is active, a message "PROGRESS" appears on the screen. (➔ page 48)

Pressing this button toggles the projector's internal mechanical shutter to black out the projector. (➔ page 47)

Switches the image aspect ratio. (➔ page 49)

These buttons are used together with     to adjust focus, zoom and shift by the projection lens. (➔ pages 40, 42)

Assign the frequently use functions from options for shortcut. (➔ page 48)

Restores the default factory setting. (➔ page 50)

Specifies the ID of the remote control. (➔ page 21)

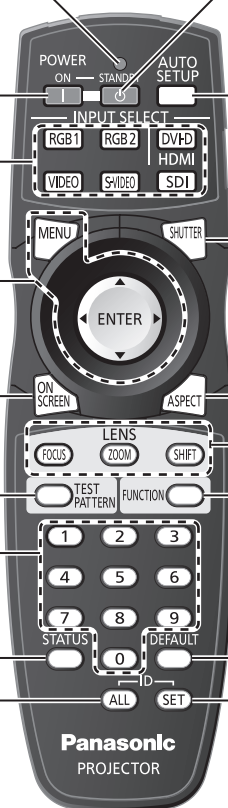

Attention

- Do not drop the remote control.
- Avoid contact with liquids or moisture.
- Do not attempt to modify or disassemble the remote control.
- Do not let strong light shine onto the signal receptor. The remote control may malfunction under strong light such as fluorescent.

Note

- The remote control can be used within a distance of about 30 m if pointed directly at the remote control receiver. The remote control can control at angles of up to $\pm 15^\circ$ vertically and $\pm 30^\circ$ horizontally, but the effective control range may be reduced.
- If there are any obstacles between the remote control and the remote control signal receptor, the remote control may not operate correctly.
The signal will be reflected off the screen. The operating range may differ due to the screen material.
- When the projector receives a signal from the remote control, the Power indicator will flash.

Projector body

Front view

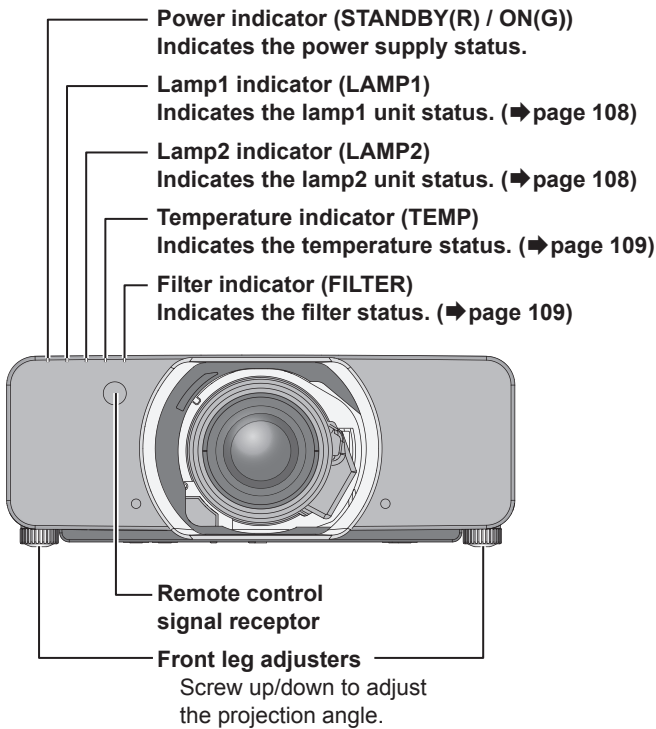

Side views

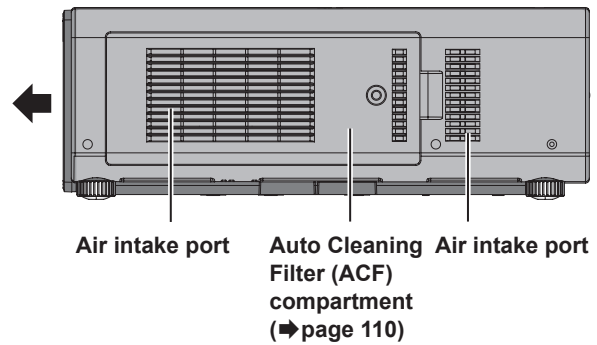
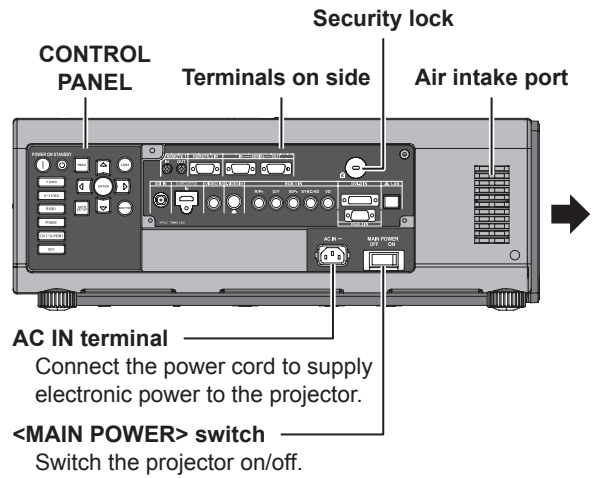

Rear view

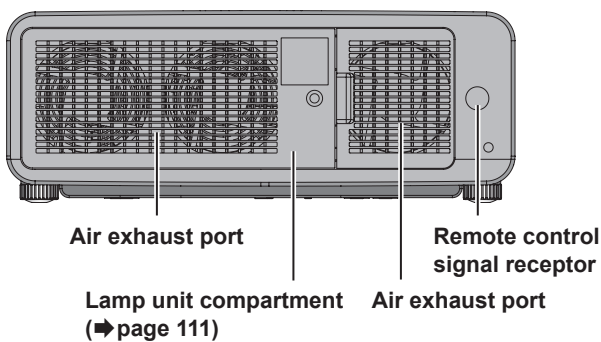

Bottom view

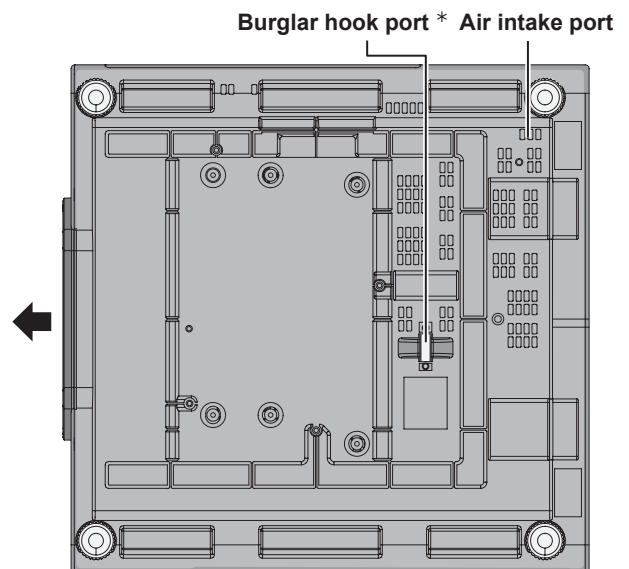

*: Attach a commercial burglar prevention cable.

Attention

- Keep your hands and other objects away from the air outlet port.
- Keep your hand and face away.
 - Keep heat-sensitive articles away.
 - Inserting your finger may result in injury.
- Heated air from the air outlet port can cause burns or deformations.

About Your Projector

CONTROL PANEL

<STANDBY> button

Returns to the standby mode.

<POWER ON> button

Starts the projection while in the standby mode.

VIDEO

Switches to VIDEO input.

S-VIDEO

Switches to S-VIDEO input.

RGB1

Switches to RGB1 input.

RGB2

Switches to RGB2 input.

DVI-D/HDMI

Switches to DVI-D or HDMI input.

SDI

Switches to SDI input.
(PT-DZ110XE/PT-DS100XE only)

<MENU> button

Displays and clears the main menu, and returns to the previous menu when the menu is displayed.
If you hold it down for at least 3 seconds while the on-screen indication is [OFF], the [OFF] state is canceled. (➔page 50)

<LENS> button

This button is used together with ▲▼◀▶ to adjust focus, zoom and shift by the projection lens.

<ENTER> button

Press to activate a menu selection or to initiate a function.

<SHUTTER> button

Pressing this button toggles the projector's internal mechanical shutter to black out the projector. (➔page 47)

▲▼◀▶ button

Use these buttons to select menu items, change settings, adjust levels, and to enter the [SECURITY] password.

<AUTO SETUP> button

Pressing this button while projecting an image automatically corrects the picture positioning on the screen. While the auto setup feature is active, a message "PROGRESS" appears on the screen. (➔page 48)

Terminals on side

REMOTE 2 IN

Connect a cable from an external control circuit.

REMOTE 1 IN/OUT

When two or more main units are used in the system, they can be connected and controlled with wired remote control cable.

SDI IN

Connect an SDI signals.
(PT-DZ110XE/PT-DS100XE only)

HDMI IN

Connect a HDMI signals.

VIDEO IN

Connect a VIDEO signals.

S-VIDEO IN

Connect an S-VIDEO signals.

SERIAL IN/OUT

Connect an RS-232C cable from/to a computer.

DVI-D IN

Connect a single link DVI-D signals.

LAN

Connect a LAN cable for network connection.

RGB2 IN

Connect an RGB or YP_BP_R signals.

RGB (YP_BP_R)1 IN

Connect an RGB or YP_BP_R signals.

Attention

- Do not touch the LAN terminal with your bare hands or body, as body parts may have charged static electricity. Failure to do so may cause malfunctions.
Do not touch the metallic parts of LAN terminal and cable.
- Please connect the LAN to indoor devices only.

Setting projector ID number to remote control

Each projector can be assigned a unique ID number, and the handheld remote's number must be set to match the intended projector.

The ID number of the projector is set to "ALL" on shipping, and use the ID ALL button of the remote control when using only a single projector.

- 1) Press <ID SET> button, and the projector (s) will display it's current ID number onscreen. Within 5 seconds, use the numeric keys (0-9) to match the Remote's ID number with that of the desired projector.

Attention

- Do not press <ID SET> button accidentally or carelessly because the ID number on the remote control can be set even when no projector is around.
- If you do not enter the 2 digits ID number within 5 seconds after <ID SET> button has been pressed, the ID will remain at the number that was set before <ID SET> button was pressed.
- Your specified ID number is stored in the remote control unit unless another one is specified later. However, the stored ID will be erased if the batteries of the remote control are left exhausted. When the batteries are replaced, set the same ID number again.
- The ID number can be set to "ALL" or from "1" to "64".

Note

- Refer to "PROJECTOR ID" of "PROJECTOR SETUP menu" (▶page 76).

Using a wired remote control

When multiple projectors are connected as part of the system, connect to units with a M3 stereo mini jack commercial cable to simultaneously control multiple main units with a single remote control through the REMOTE 1 IN/OUT terminal. It is effective to use the wired remote control in the environment in which an obstacle stands in the light path or where devices are susceptible to outside light.

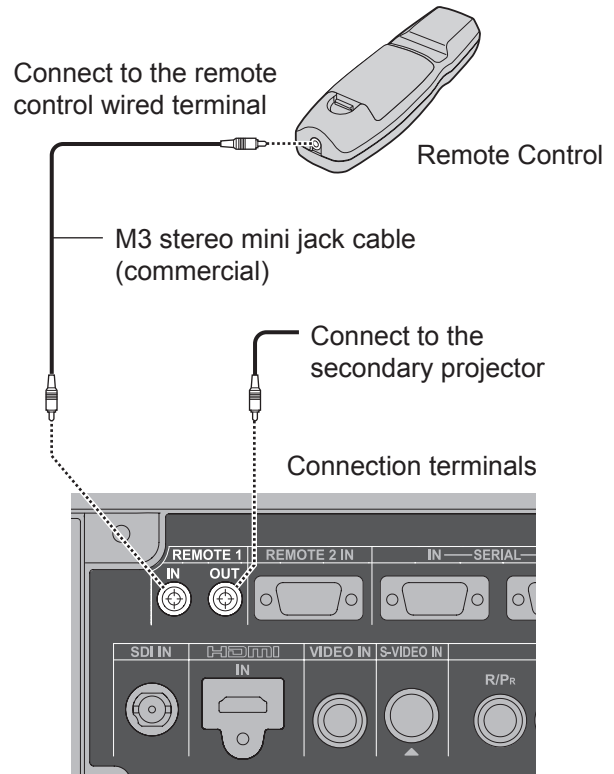

Attention

- Use 2 core shielded cable of length of 15 m or less. If the length of the cable exceeds 15 m (49' 2"), the shielding of the cable may not be sufficient and the remote control may not work.

Setting up

Projection method

You can use the projector with any of the following 4 projection methods. To set the desired method in the projector.

■ Mounting on the ceiling and projecting from front

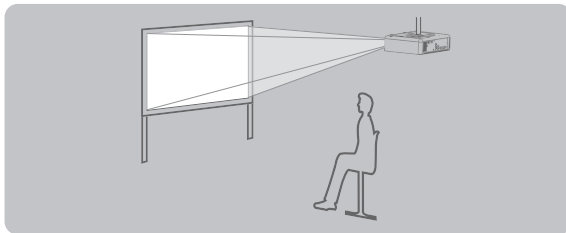

Menu *	Method
INSTALLATION	FRONT/CEILING
COOLING CONDITION	CEILING SETTING

■ Setting on a desk/floor and projecting from rear

(Using translucent screen)

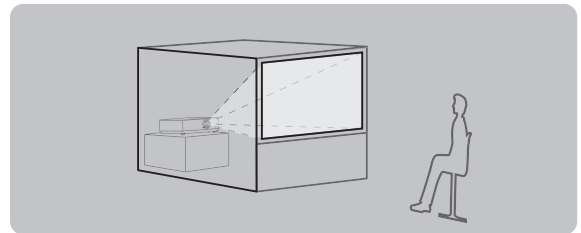

Menu *	Method
INSTALLATION	REAR/FLOOR
COOLING CONDITION	FLOOR SETTING

■ Mounting on the ceiling and projecting from rear

(Using translucent screen)

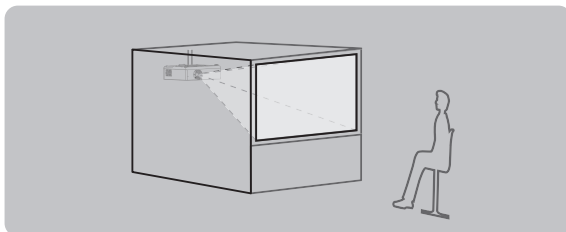

Menu *	Method
INSTALLATION	REAR/CEILING
COOLING CONDITION	CEILING SETTING

■ Setting on a desk/floor and projecting from front

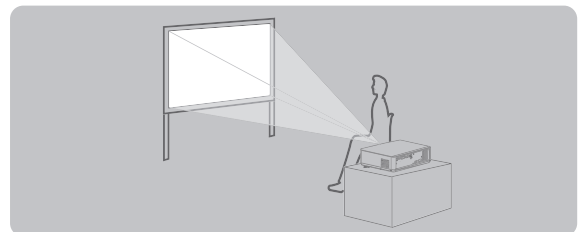

Menu *	Method
INSTALLATION	FRONT/FLOOR
COOLING CONDITION	FLOOR SETTING

*: Refer to "INSTALLATION" of "PROJECTOR SETUP menu" and "COOLING CONDITION" (➡ pages 76, 77) for details.

Screen size and throw distance

When planning the projector and screen geometry, refer to the figures below and the information on the following pages for reference. After the projector is roughly positioned, picture size and vertical picture positioning can be finely adjusted with the powered zoom lens and lens shifting mechanism.

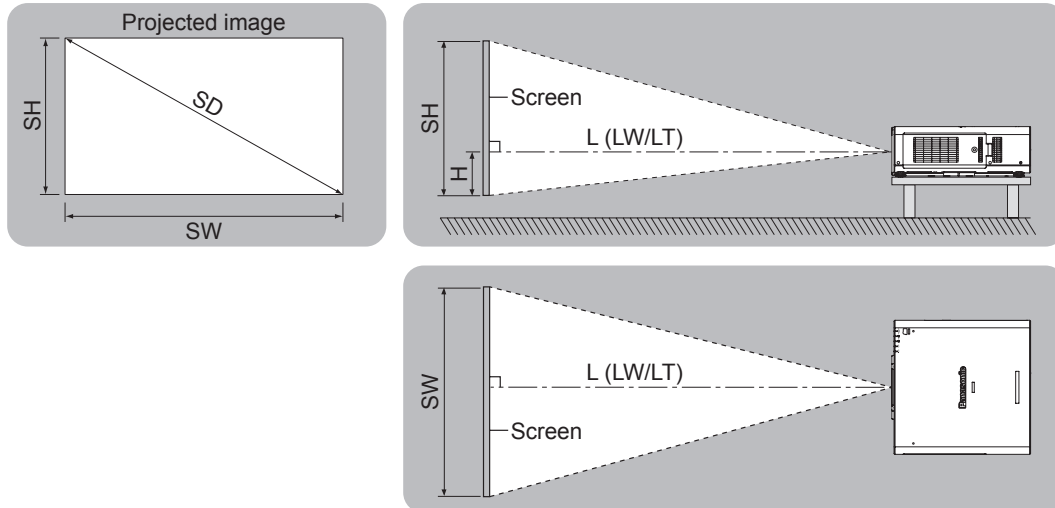

L (LW/LT) *	Projection distance (m)
SH	Height of the projection area (m)
SW	Width of the projection area (m)
H	Vertical distance between the lens center level and the bottom edge of the projected image. (m)
SD	Diagonal length of the projection area (")

*: LW : Minimum distance
 LT : Maximum distance

Attention

- Before installing, please read "Precautions with regard to safety" (➔ pages 9 to 17)
- Special care should be used when DLP projectors are used in the same room as high power laser equipment. Direct or indirect hitting of a laser beam on to the lens can severely damage the Digital Mirror Devices™ in which case there is a loss of warranty.

Setting up

Projected range using geometric adjustment (PT-DZ110XE/PT-DS100XE only)

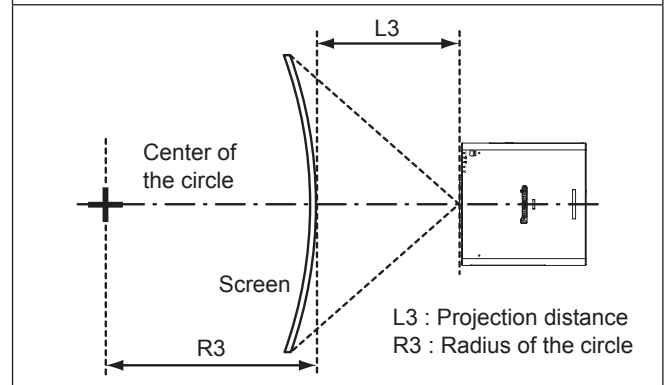
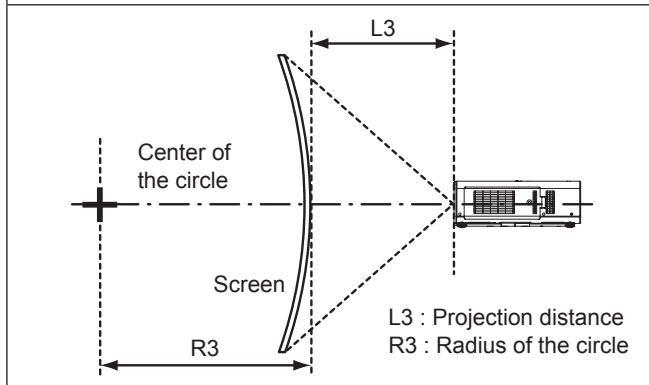
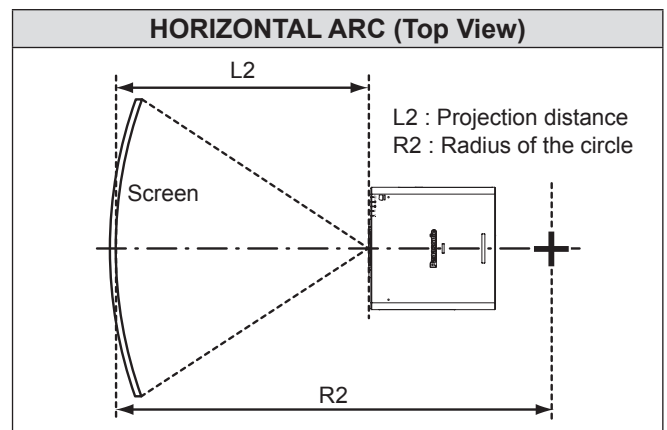
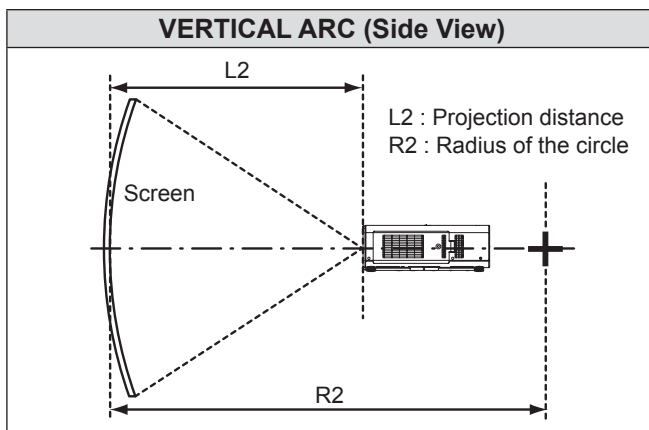
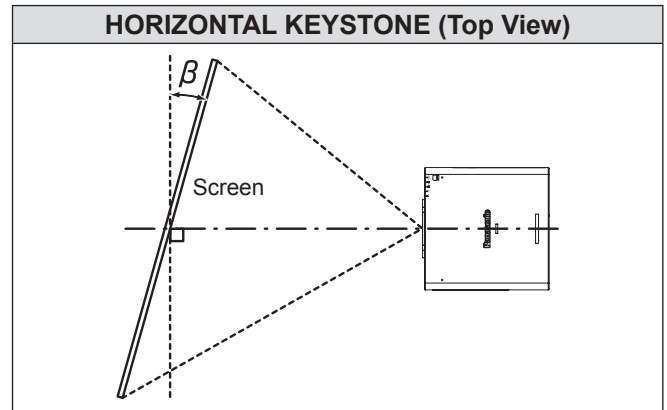
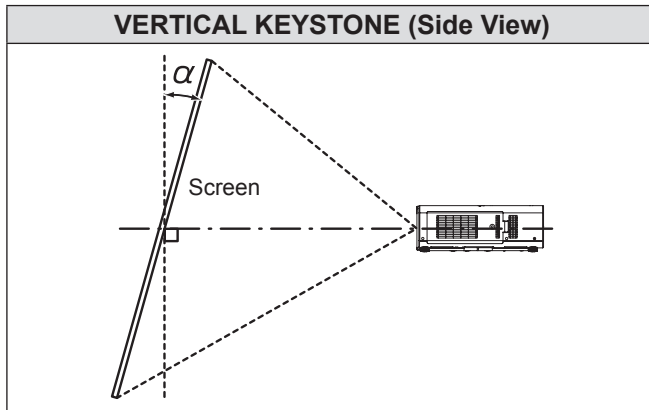

Lens	Keystone correction only		When using arc and keystone correction together				Arc correction only	
	Vertical Keystone Correction Angle α (°)	Horizontal Keystone Correction Angle β (°)	Vertical Keystone Correction Angle α (°)	Horizontal Keystone Correction Angle β (°)	R2/L2 minimum value	R3/L3 minimum value	R2/L2 minimum value	R3/L3 minimum value
ET-D75LE1	±40	±15	±5	±5	1.6	3.2	0.8	1.6
ET-D75LE2	±40	±15	±5	±5	1.2	2.4	0.6	1.2
ET-D75LE3	±40	±15	±10	±10	0.8	1.6	0.4	0.8
ET-D75LE4	±40	±15	±10	±15	0.6	1.0	0.3	0.5
ET-D75LE5	±22	±15	±5	±5	3.0	6.0	1.5	3.0
ET-D75LE6	±28	±10	±5	±5	2.4	4.8	1.2	2.4
ET-D75LE8	±40	±15	±10	±15	0.4	0.8	0.2	0.4
ET-D75LE10	±40	±15	±5	±5	1.6	3.2	0.8	1.6
ET-D75LE20	±40	±15	±5	±5	1.6	3.2	0.8	1.6
ET-D75LE30	±40	±15	±5	±5	1.2	2.4	0.6	1.2

Note

- When using geometric adjustment, if the amount of compensation is too great, excessive blurring may result.
- The curved screens illustrated are simply sections of a full circle.

■ Projection distance by projection lens (for PT-DZ110XE)

● For the screen aspect ratio of 16 : 10 (Unit : m)

Lens type			Zoom lens									
Model number of projection lens			ET-D75LE1		ET-D75LE2		ET-D75LE3		ET-D75LE4		ET-D75LE8	
Throw ratio *			1.4–1.8 : 1		1.8–2.8 : 1		2.8–4.6 : 1		4.6–7.4 : 1		7.3–13.8 : 1	
Screen dimensions			Projection distance (L)									
Screen size (")	Effective height (SH)	Effective width (SW)	Min. (LW)	Max. (LT)	Min. (LW)	Max. (LT)	Min. (LW)	Max. (LT)	Min. (LW)	Max. (LT)	Min. (LW)	Max. (LT)
70	0.942	1.508	2.01	2.69	2.72	4.10	4.11	6.90	6.91	11.06	10.78	20.56
80	1.077	1.723	2.31	3.09	3.12	4.70	4.71	7.90	7.91	12.66	12.37	23.55
90	1.212	1.939	2.61	3.49	3.52	5.30	5.31	8.91	8.91	14.25	13.97	26.54
100	1.346	2.154	2.91	3.89	3.92	5.90	5.91	9.91	9.91	15.85	15.57	29.53
120	1.615	2.585	3.51	4.68	4.73	7.10	7.11	11.91	11.92	19.04	18.76	35.50
150	2.019	3.231	4.40	5.88	5.93	8.90	8.91	14.92	14.93	23.82	23.54	44.47
200	2.692	4.308	5.89	7.87	7.93	11.91	11.92	19.94	19.95	31.80	31.52	59.41
250	3.365	5.385	7.39	9.87	9.93	14.91	14.92	24.95	24.96	39.77	39.49	74.36
300	4.039	6.462	8.88	11.86	11.93	17.91	17.92	29.97	29.98	47.75	47.47	89.30
350	4.712	7.539	10.37	13.86	13.93	20.91	20.92	34.98	34.99	55.72	55.44	104.24
400	5.385	8.616	11.86	15.85	15.94	23.92	23.93	40.00	40.01	63.70	63.42	119.19
500	6.731	10.770	14.85	19.84	19.94	29.92	29.93	50.03	50.04	79.65	79.37	149.08
600	8.077	12.923	17.83	23.82	23.94	35.93	35.94	60.06	60.07	95.60	95.32	178.96

Lens type			Zoom lens								Fixed-focus lens
Model number of projection lens			ET-D75LE6		ET-D75LE10		ET-D75LE20		ET-D75LE30		ET-D75LE5
Throw ratio *			0.9–1.1 : 1		1.3–1.7 : 1		1.7–2.4 : 1		2.4–4.7 : 1		0.7 : 1
Screen dimensions			Projection distance (L)								
Screen size (")	Effective height (SH)	Effective width (SW)	Min. (LW)	Max. (LT)	Min. (LW)	Max. (LT)	Min. (LW)	Max. (LT)	Min. (LW)	Max. (LT)	Fixed
70	0.942	1.508	1.35	1.62	1.90	2.46	2.46	3.58	3.56	6.94	0.99
80	1.077	1.723	1.55	1.86	2.19	2.83	2.82	4.11	4.08	7.96	1.15
90	1.212	1.939	1.76	2.10	2.47	3.20	3.19	4.64	4.61	8.98	1.30
100	1.346	2.154	1.96	2.34	2.76	3.56	3.55	5.17	5.13	9.99	1.45
120	1.615	2.585	2.36	2.82	3.32	4.30	4.28	6.22	6.18	12.03	1.76
150	2.019	3.231	2.96	3.55	4.18	5.40	5.37	7.81	7.75	15.08	2.22
200	2.692	4.308	3.97	4.75	5.60	7.24	7.19	10.45	10.38	20.16	2.99
250	3.365	5.385	4.98	5.96	7.02	9.07	9.00	13.09	13.00	25.25	3.76
300	4.039	6.462	5.99	7.17	8.44	10.91	10.82	15.73	15.62	30.34	4.53
350	4.712	7.539	6.99	8.37	9.86	12.74	12.64	18.37	18.24	35.42	
400	5.385	8.616	8.00	9.58	11.28	14.58	14.46	21.01	20.86	40.51	
500	6.731	10.770	10.01	11.99	14.12	18.25	18.09	26.29	26.11	50.68	
600	8.077	12.923	12.03	14.40	16.96	21.92	21.73	31.58	31.35	60.85	

*: The throw ratio is based on the value during projection onto a 150-inch screen size.

Note

- The projection distances listed here involve an error of ±5 %.
- When geometric adjustment is used, compensation is made so that the screen size becomes smaller than the specified size.

Setting up

● For the screen aspect ratio of 16 : 9 (Unit : m)

Lens type			Zoom lens									
Model number of projection lens			ET-D75LE1		ET-D75LE2		ET-D75LE3		ET-D75LE4		ET-D75LE8	
Throw ratio *			1.4–1.8 : 1		1.8–2.8 : 1		2.8–4.6 : 1		4.6–7.4 : 1		7.3–13.8 : 1	
Screen dimensions			Projection distance (L)									
Screen size (")	Effective height (SH)	Effective width (SW)	Min. (LW)	Max. (LT)	Min. (LW)	Max. (LT)	Min. (LW)	Max. (LT)	Min. (LW)	Max. (LT)	Min. (LW)	Max. (LT)
70	0.872	1.550	2.07	2.77	2.80	4.21	4.23	7.09	7.10	11.37	11.09	21.14
80	0.996	1.771	2.38	3.18	3.21	4.83	4.84	8.13	8.13	13.01	12.73	24.21
90	1.121	1.992	2.68	3.59	3.62	5.45	5.46	9.16	9.16	14.65	14.37	27.29
100	1.245	2.214	2.99	4.00	4.04	6.07	6.08	10.19	10.19	16.29	16.01	30.36
120	1.494	2.657	3.60	4.82	4.86	7.30	7.31	12.25	12.26	19.57	19.29	36.50
150	1.868	3.321	4.53	6.05	6.09	9.15	9.16	15.34	15.35	24.49	24.21	45.72
200	2.491	4.428	6.06	8.10	8.15	12.24	12.25	20.50	20.50	32.69	32.40	61.08
250	3.113	5.535	7.59	10.15	10.21	15.33	15.34	25.65	25.66	40.88	40.60	76.44
300	3.736	6.641	9.13	12.19	12.27	18.41	18.42	30.81	30.81	49.08	48.80	91.79
350	4.358	7.748	10.66	14.24	14.32	21.50	21.51	35.96	35.97	57.28	57.00	107.15
400	4.981	8.855	12.19	16.29	16.38	24.58	24.60	41.12	41.12	65.47	65.19	122.51
500	6.226	11.069	15.26	20.39	20.50	30.76	30.77	51.42	51.43	81.87	81.59	153.23
600	7.472	13.283	18.33	24.49	24.61	36.93	36.94	61.73	61.74	98.26	97.98	183.95

Lens type			Zoom lens								Fixed-focus lens
Model number of projection lens			ET-D75LE6		ET-D75LE10		ET-D75LE20		ET-D75LE30		ET-D75LE5
Throw ratio *			0.9–1.1 : 1		1.3–1.7 : 1		1.7–2.4 : 1		2.4–4.7 : 1		0.7 : 1
Screen dimensions			Projection distance (L)								
Screen size (")	Effective height (SH)	Effective width (SW)	Min. (LW)	Max. (LT)	Min. (LW)	Max. (LT)	Min. (LW)	Max. (LT)	Min. (LW)	Max. (LT)	Fixed
70	0.872	1.550	1.39	1.66	1.96	2.53	2.53	3.68	3.66	7.14	1.02
80	0.996	1.771	1.60	1.91	2.25	2.91	2.91	4.23	4.20	8.19	1.18
90	1.121	1.992	1.81	2.16	2.54	3.29	3.28	4.77	4.74	9.23	1.34
100	1.245	2.214	2.01	2.41	2.83	3.67	3.65	5.31	5.28	10.28	1.50
120	1.494	2.657	2.43	2.90	3.42	4.42	4.40	6.40	6.35	12.37	1.81
150	1.868	3.321	3.05	3.65	4.29	5.55	5.52	8.03	7.97	15.50	2.29
200	2.491	4.428	4.08	4.89	5.75	7.44	7.39	10.74	10.67	20.73	3.08
250	3.113	5.535	5.12	6.13	7.21	9.33	9.26	13.46	13.36	25.96	3.87
300	3.736	6.641	6.15	7.37	8.67	11.21	11.13	16.17	16.06	31.18	4.66
350	4.358	7.748	7.19	8.61	10.13	13.10	12.99	18.88	18.75	36.41	
400	4.981	8.855	8.22	9.85	11.59	14.99	14.86	21.60	21.45	41.64	
500	6.226	11.069	10.29	12.33	14.51	18.76	18.60	27.03	26.84	52.09	
600	7.472	13.283	12.36	14.81	17.44	22.54	22.33	32.46	32.23	62.54	

*: The throw ratio is based on the value during projection onto a 150-inch screen size.

Note

- The projection distances listed here involve an error of $\pm 5\%$.
- When geometric adjustment is used, compensation is made so that the screen size becomes smaller than the specified size.

● For the screen aspect ratio of 4 : 3 (Unit : m)

Lens type			Zoom lens									
Model number of projection lens			ET-D75LE1		ET-D75LE2		ET-D75LE3		ET-D75LE4		ET-D75LE8	
Throw ratio *			1.6–2.2 : 1		2.2–3.3 : 1		3.3–5.6 : 1		5.6–8.9 : 1		8.8–16.5 : 1	
Screen dimensions			Projection distance (L)									
Screen size (")	Effective height (SH)	Effective width (SW)	Min. (LW)	Max. (LT)	Min. (LW)	Max. (LT)	Min. (LW)	Max. (LT)	Min. (LW)	Max. (LT)	Min. (LW)	Max. (LT)
70	1.067	1.422	2.29	3.06	3.09	4.65	4.66	7.83	7.83	12.54	12.25	23.32
80	1.219	1.626	2.63	3.51	3.55	5.33	5.34	8.96	8.97	14.34	14.06	26.71
90	1.372	1.829	2.96	3.96	4.00	6.01	6.02	10.10	10.10	16.15	15.87	30.09
100	1.524	2.032	3.30	4.41	4.45	6.69	6.70	11.23	11.24	17.96	17.67	33.47
120	1.829	2.438	3.98	5.32	5.36	8.05	8.06	13.50	13.51	21.57	21.28	40.24
150	2.286	3.048	4.99	6.67	6.72	10.09	10.10	16.91	16.92	26.98	26.70	50.39
200	3.048	4.064	6.68	8.93	8.99	13.49	13.50	22.59	22.59	36.01	35.73	67.31
250	3.810	5.080	8.37	11.18	11.25	16.89	16.90	28.27	28.27	45.04	44.76	84.23
300	4.572	6.096	10.06	13.44	13.52	20.29	20.30	33.94	33.95	54.07	53.79	101.14
350	5.334	7.112	11.75	15.70	15.79	23.69	23.70	39.62	39.63	63.10	62.82	118.06
400	6.096	8.128	13.44	17.96	18.05	27.09	27.10	45.30	45.31	72.13	71.85	134.98
500	7.620	10.160	16.82	22.47	22.58	33.89	33.90	56.65	56.66	90.18	89.91	168.81
600	9.144	12.192	20.20	26.98	27.12	40.69	40.70	68.01	68.02	108.24	107.96	202.65

Lens type			Zoom lens								Fixed-focus lens
Model number of projection lens			ET-D75LE6		ET-D75LE10		ET-D75LE20		ET-D75LE30		ET-D75LE5
Throw ratio *			1.1–1.3 : 1		1.6–2.0 : 1		2.0–2.9 : 1		2.9–5.6 : 1		0.8 : 1
Screen dimensions			Projection distance (L)								Fixed
Screen size (")	Effective height (SH)	Effective width (SW)	Min. (LW)	Max. (LT)	Min. (LW)	Max. (LT)	Min. (LW)	Max. (LT)	Min. (LW)	Max. (LT)	Fixed
70	1.067	1.422	1.54	1.84	2.17	2.80	2.80	4.07	4.04	7.88	1.13
80	1.219	1.626	1.77	2.11	2.49	3.22	3.21	4.67	4.64	9.03	1.31
90	1.372	1.829	2.00	2.38	2.81	3.63	3.62	5.27	5.23	10.19	1.48
100	1.524	2.032	2.22	2.66	3.13	4.05	4.03	5.86	5.82	11.34	1.66
120	1.829	2.438	2.68	3.20	3.77	4.88	4.86	7.06	7.01	13.64	2.00
150	2.286	3.048	3.36	4.02	4.74	6.13	6.09	8.85	8.79	17.09	2.53
200	3.048	4.064	4.50	5.39	6.35	8.21	8.15	11.84	11.76	22.85	3.40
250	3.810	5.080	5.64	6.76	7.96	10.28	10.20	14.83	14.73	28.61	4.27
300	4.572	6.096	6.78	8.12	9.56	12.36	12.26	17.82	17.70	34.36	5.14
350	5.334	7.112	7.92	9.49	11.17	14.44	14.32	20.81	20.67	40.12	
400	6.096	8.128	9.06	10.85	12.78	16.52	16.38	23.80	23.63	45.88	
500	7.620	10.160	11.34	13.58	16.00	20.68	20.49	29.78	29.57	57.39	
600	9.144	12.192	13.62	16.32	19.21	24.83	24.61	35.76	35.51	68.91	

*: The throw ratio is based on the value during projection onto a 150-inch screen size.

Note

- The projection distances listed here involve an error of $\pm 5\%$.
- When geometric adjustment is used, compensation is made so that the screen size becomes smaller than the specified size.

Setting up

■ Projection distance by projection lens (for PT-DS100XE)

● For the screen aspect ratio of 4 : 3 (Unit : m)

Lens type			Zoom lens									
Model number of projection lens			ET-D75LE1		ET-D75LE2		ET-D75LE3		ET-D75LE4		ET-D75LE8	
Throw ratio *			1.5–2.0 : 1		2.0–3.0 : 1		3.0–5.0 : 1		5.0–8.0 : 1		7.9–15.0 : 1	
Screen dimensions			Projection distance (L)									
Screen size (")	Effective height (SH)	Effective width (SW)	Min. (LW)	Max. (LT)	Min. (LW)	Max. (LT)	Min. (LW)	Max. (LT)	Min. (LW)	Max. (LT)	Min. (LW)	Max. (LT)
70	1.067	1.422	2.07	2.77	2.80	4.21	4.23	7.09	7.10	11.37	11.09	21.14
80	1.219	1.626	2.38	3.18	3.21	4.83	4.84	8.13	8.13	13.01	12.73	24.21
90	1.372	1.829	2.68	3.59	3.62	5.45	5.46	9.16	9.16	14.65	14.37	27.29
100	1.524	2.032	2.99	4.00	4.04	6.07	6.08	10.19	10.19	16.29	16.01	30.36
120	1.829	2.438	3.60	4.82	4.86	7.30	7.31	12.25	12.26	19.57	19.29	36.50
150	2.286	3.048	4.53	6.05	6.09	9.15	9.16	15.34	15.35	24.49	24.21	45.72
200	3.048	4.064	6.06	8.10	8.15	12.24	12.25	20.50	20.50	32.69	32.40	61.08
250	3.810	5.080	7.59	10.15	10.21	15.33	15.34	25.65	25.66	40.88	40.60	76.44
300	4.572	6.096	9.13	12.19	12.27	18.41	18.42	30.81	30.81	49.08	48.80	91.79
350	5.334	7.112	10.66	14.24	14.32	21.50	21.51	35.96	35.97	57.28	57.00	107.15
400	6.096	8.128	12.19	16.29	16.38	24.58	24.60	41.12	41.12	65.47	65.19	122.51
500	7.620	10.160	15.26	20.39	20.50	30.76	30.77	51.42	51.43	81.87	81.59	153.23
600	9.144	12.192	18.33	24.49	24.61	36.93	36.94	61.73	61.74	98.26	97.98	183.95

Lens type			Zoom lens								Fixed-focus lens
Model number of projection lens			ET-D75LE6		ET-D75LE10		ET-D75LE20		ET-D75LE30		ET-D75LE5
Throw ratio *			1.0–1.2 : 1		1.4–1.8 : 1		1.8–2.6 : 1		2.6–5.1 : 1		0.8 : 1
Screen dimensions			Projection distance (L)								
Screen size (")	Effective height (SH)	Effective width (SW)	Min. (LW)	Max. (LT)	Min. (LW)	Max. (LT)	Min. (LW)	Max. (LT)	Min. (LW)	Max. (LT)	Fixed
70	1.067	1.422	1.39	1.66	1.95	2.52	2.52	3.66	3.64	7.10	1.02
80	1.219	1.626	1.60	1.91	2.24	2.89	2.89	4.20	4.17	8.13	1.18
90	1.372	1.829	1.81	2.16	2.53	3.27	3.26	4.74	4.71	9.17	1.34
100	1.524	2.032	2.01	2.41	2.82	3.64	3.63	5.28	5.24	10.21	1.50
120	1.829	2.438	2.43	2.90	3.40	4.39	4.37	6.36	6.31	12.29	1.81
150	2.286	3.048	3.05	3.65	4.27	5.52	5.49	7.98	7.92	15.41	2.29
200	3.048	4.064	4.08	4.89	5.72	7.39	7.34	10.67	10.60	20.60	3.08
250	3.810	5.080	5.12	6.13	7.17	9.27	9.20	13.37	13.28	25.79	3.87
300	4.572	6.096	6.15	7.37	8.62	11.14	11.06	16.07	15.96	30.99	4.66
350	5.334	7.112	7.19	8.61	10.07	13.02	12.91	18.77	18.63	36.18	
400	6.096	8.128	8.22	9.85	11.52	14.90	14.77	21.46	21.31	41.38	
500	7.620	10.160	10.29	12.33	14.42	18.65	18.48	26.86	26.67	51.77	
600	9.144	12.192	12.36	14.81	17.33	22.40	22.19	32.25	32.03	62.15	

*: The throw ratio is based on the value during projection onto a 150-inch screen size.

Note

- The projection distances listed here involve an error of $\pm 5\%$.
- When geometric adjustment is used, compensation is made so that the screen size becomes smaller than the specified size.

● For the screen aspect ratio of 16 : 9 (Unit : m)

Lens type			Zoom lens									
Model number of projection lens			ET-D75LE1		ET-D75LE2		ET-D75LE3		ET-D75LE4		ET-D75LE8	
Throw ratio *			1.5–2.0 : 1		2.0–3.0 : 1		3.0–5.0 : 1		5.0–8.0 : 1		8.0–15.0 : 1	
Screen dimensions			Projection distance (L)									
Screen size (")	Effective height (SH)	Effective width (SW)	Min. (LW)	Max. (LT)	Min. (LW)	Max. (LT)	Min. (LW)	Max. (LT)	Min. (LW)	Max. (LT)	Min. (LW)	Max. (LT)
70	0.872	1.550	2.26	3.02	3.06	4.60	4.61	7.74	7.75	12.40	12.12	23.06
80	0.996	1.771	2.60	3.47	3.51	5.27	5.28	8.86	8.87	14.18	13.90	26.41
90	1.121	1.992	2.93	3.92	3.95	5.95	5.96	9.99	9.99	15.97	15.69	29.76
100	1.245	2.214	3.27	4.36	4.40	6.62	6.63	11.11	11.11	17.76	17.47	33.10
120	1.494	2.657	3.93	5.26	5.30	7.96	7.97	13.35	13.36	21.33	21.04	39.79
150	1.868	3.321	4.94	6.60	6.64	9.98	9.99	16.72	16.73	26.68	26.40	49.83
200	2.491	4.428	6.61	8.83	8.89	13.34	13.35	22.34	22.34	35.61	35.33	66.56
250	3.113	5.535	8.28	11.06	11.13	16.70	16.71	27.95	27.96	44.54	44.26	83.29
300	3.736	6.641	9.95	13.29	13.37	20.07	20.08	33.57	33.57	53.47	53.19	100.02
350	4.358	7.748	11.62	15.52	15.61	23.43	23.44	39.18	39.19	62.40	62.12	116.75
400	4.981	8.855	13.29	17.76	17.85	26.79	26.80	44.80	44.80	71.33	71.05	133.48
500	6.226	11.069	16.63	22.22	22.33	33.51	33.52	56.03	56.03	89.19	88.91	166.95
600	7.472	13.283	19.97	26.69	26.82	40.24	40.25	67.26	67.26	107.04	106.77	200.41

Lens type			Zoom lens								Fixed-focus lens
Model number of projection lens			ET-D75LE6		ET-D75LE10		ET-D75LE20		ET-D75LE30		ET-D75LE5
Throw ratio *			1.0–1.2 : 1		1.4–1.8 : 1		1.8–2.6 : 1		2.6–5.1 : 1		0.8 : 1
Screen dimensions			Projection distance (L)								
Screen size (")	Effective height (SH)	Effective width (SW)	Min. (LW)	Max. (LT)	Min. (LW)	Max. (LT)	Min. (LW)	Max. (LT)	Min. (LW)	Max. (LT)	Fixed
70	0.872	1.550	1.52	1.82	2.13	2.75	2.75	4.00	3.97	7.74	1.12
80	0.996	1.771	1.75	2.09	2.44	3.16	3.15	4.59	4.55	8.88	1.29
90	1.121	1.992	1.97	2.36	2.76	3.57	3.56	5.17	5.14	10.01	1.47
100	1.245	2.214	2.20	2.63	3.08	3.98	3.96	5.76	5.72	11.14	1.64
120	1.494	2.657	2.65	3.17	3.71	4.79	4.77	6.94	6.89	13.40	1.98
150	1.868	3.321	3.33	3.98	4.66	6.02	5.98	8.70	8.64	16.80	2.50
200	2.491	4.428	4.45	5.33	6.24	8.06	8.01	11.64	11.56	22.46	3.36
250	3.113	5.535	5.58	6.68	7.82	10.11	10.03	14.58	14.47	28.11	4.22
300	3.736	6.641	6.71	8.03	9.40	12.15	12.05	17.51	17.39	33.77	5.08
350	4.358	7.748	7.84	9.38	10.98	14.19	14.07	20.45	20.31	39.43	
400	4.981	8.855	8.96	10.73	12.56	16.23	16.10	23.39	23.23	45.09	
500	6.226	11.069	11.22	13.43	15.72	20.32	20.14	29.27	29.06	56.40	
600	7.472	13.283	13.47	16.14	18.88	24.41	24.18	35.15	34.90	67.72	

*: The throw ratio is based on the value during projection onto a 150-inch screen size.

Note

- The projection distances listed here involve an error of $\pm 5\%$.
- When geometric adjustment is used, compensation is made so that the screen size becomes smaller than the specified size.

Setting up

■ Projection distance by projection lens (for PT-DW90XE)

● For the screen aspect ratio of 16 : 9 (Unit : m)

Lens type			Zoom lens									
Model number of projection lens			ET-D75LE1		ET-D75LE2		ET-D75LE3		ET-D75LE4		ET-D75LE8	
Throw ratio *			1.5–2.0 : 1		2.1–3.1 : 1		3.1–5.2 : 1		5.2–8.2 : 1		8.2–15.4 : 1	
Screen dimensions			Projection distance (L)									
Screen size (")	Effective height (SH)	Effective width (SW)	Min. (LW)	Max. (LT)	Min. (LW)	Max. (LT)	Min. (LW)	Max. (LT)	Min. (LW)	Max. (LT)	Min. (LW)	Max. (LT)
70	0.872	1.550	2.32	3.10	3.14	4.72	4.73	7.94	7.94	12.71	12.43	23.65
80	0.996	1.771	2.66	3.56	3.60	5.41	5.42	9.09	9.09	14.54	14.26	27.08
90	1.121	1.992	3.01	4.02	4.06	6.10	6.11	10.24	10.25	16.37	16.09	30.51
100	1.245	2.214	3.35	4.48	4.52	6.79	6.80	11.39	11.40	18.21	17.92	33.94
120	1.494	2.657	4.03	5.39	5.44	8.17	8.18	13.69	13.70	21.87	21.58	40.80
150	1.868	3.321	5.06	6.76	6.81	10.23	10.24	17.15	17.15	27.36	27.08	51.09
200	2.491	4.428	6.77	9.05	9.11	13.68	13.69	22.90	22.91	36.51	36.23	68.25
250	3.113	5.535	8.49	11.34	11.41	17.13	17.14	28.66	28.67	45.67	45.39	85.40
300	3.736	6.641	10.20	13.63	13.71	20.57	20.58	34.42	34.42	54.82	54.54	102.55
350	4.358	7.748	11.91	15.92	16.00	24.02	24.03	40.17	40.18	63.97	63.70	119.70
400	4.981	8.855	13.63	18.21	18.30	27.47	27.48	45.93	45.93	73.13	72.85	136.85
500	6.226	11.069	17.05	22.78	22.90	34.36	34.37	57.44	57.45	91.43	91.16	171.16
600	7.472	13.283	20.48	27.36	27.49	41.25	41.26	68.95	68.96	109.74	109.47	205.46

Lens type			Zoom lens								Fixed-focus lens	
Model number of projection lens			ET-D75LE6		ET-D75LE10		ET-D75LE20		ET-D75LE30		ET-D75LE5	
Throw ratio *			1.0–1.2 : 1		1.4–1.9 : 1		1.8–2.7 : 1		2.7–5.2 : 1		0.8 : 1	
Screen dimensions			Projection distance (L)									
Screen size (")	Effective height (SH)	Effective width (SW)	Min. (LW)	Max. (LT)	Min. (LW)	Max. (LT)	Min. (LW)	Max. (LT)	Min. (LW)	Max. (LT)	Fixed	
70	0.872	1.550	1.56	1.87	2.18	2.82	2.82	4.10	4.07	7.94	1.15	
80	0.996	1.771	1.79	2.14	2.51	3.24	3.23	4.70	4.67	9.10	1.33	
90	1.121	1.992	2.02	2.42	2.83	3.66	3.65	5.31	5.27	10.26	1.50	
100	1.245	2.214	2.25	2.70	3.15	4.08	4.06	5.91	5.87	11.42	1.68	
120	1.494	2.657	2.72	3.25	3.80	4.92	4.89	7.11	7.07	13.74	2.03	
150	1.868	3.321	3.41	4.08	4.78	6.17	6.14	8.92	8.86	17.22	2.56	
200	2.491	4.428	4.56	5.47	6.40	8.27	8.21	11.93	11.85	23.03	3.44	
250	3.113	5.535	5.72	6.85	8.02	10.36	10.28	14.95	14.84	28.83	4.33	
300	3.736	6.641	6.87	8.24	9.64	12.46	12.36	17.96	17.83	34.63	5.21	
350	4.358	7.748	8.03	9.62	11.26	14.55	14.43	20.97	20.82	40.43		
400	4.981	8.855	9.18	11.01	12.88	16.65	16.50	23.98	23.81	46.23		
500	6.226	11.069	11.49	13.78	16.12	20.83	20.65	30.01	29.80	57.83		
600	7.472	13.283	13.80	16.55	19.36	25.02	24.80	36.03	35.78	69.43		

*: The throw ratio is based on the value during projection onto a 150-inch screen size.

Note

- The projection distances listed here involve an error of $\pm 5\%$.
- When geometric adjustment is used, compensation is made so that the screen size becomes smaller than the specified size.

● For the screen aspect ratio of 4 : 3 (Unit : m)

Lens type			Zoom lens									
Model number of projection lens			ET-D75LE1		ET-D75LE2		ET-D75LE3		ET-D75LE4		ET-D75LE8	
Throw ratio *			2.0–2.7 : 1		2.7–4.1 : 1		4.1–6.9 : 1		6.9–11.0 : 1		10.9–20.6 : 1	
Screen dimensions			Projection distance (L)									
Screen size (")	Effective height (SH)	Effective width (SW)	Min. (LW)	Max. (LT)	Min. (LW)	Max. (LT)	Min. (LW)	Max. (LT)	Min. (LW)	Max. (LT)	Min. (LW)	Max. (LT)
70	1.067	1.422	2.86	3.82	3.86	5.80	5.81	9.74	9.75	15.59	15.30	29.04
80	1.219	1.626	3.28	4.38	4.42	6.65	6.66	11.15	11.16	17.83	17.55	33.24
90	1.372	1.829	3.70	4.94	4.98	7.49	7.50	12.56	12.57	20.07	19.79	37.44
100	1.524	2.032	4.12	5.50	5.55	8.33	8.34	13.97	13.98	22.31	22.03	41.64
120	1.829	2.438	4.96	6.62	6.67	10.02	10.03	16.79	16.80	26.79	26.51	50.04
150	2.286	3.048	6.21	8.30	8.36	12.55	12.56	21.02	21.03	33.52	33.24	62.64
200	3.048	4.064	8.31	11.11	11.17	16.77	16.78	28.07	28.07	44.72	44.44	83.63
250	3.810	5.080	10.41	13.91	13.99	20.99	21.00	35.12	35.12	55.93	55.65	104.63
300	4.572	6.096	12.51	16.71	16.80	25.21	25.22	42.16	42.17	67.14	66.86	125.63
350	5.334	7.112	14.60	19.51	19.61	29.43	29.44	49.21	49.22	78.34	78.07	146.63
400	6.096	8.128	16.70	22.31	22.43	33.65	33.66	56.26	56.26	89.55	89.28	167.63
500	7.620	10.160	20.89	27.92	28.05	42.09	42.10	70.35	70.36	111.96	111.69	209.62
600	9.144	12.192	25.09	33.52	33.68	50.53	50.54	84.45	84.45	134.38	134.11	251.62

Lens type			Zoom lens								Fixed-focus lens
Model number of projection lens			ET-D75LE6		ET-D75LE10		ET-D75LE20		ET-D75LE30		ET-D75LE5
Throw ratio *			1.4–1.6 : 1		1.9–2.5 : 1		2.5–3.6 : 1		3.6–6.9 : 1		1.0 : 1
Screen dimensions			Projection distance (L)								Fixed
Screen size (")	Effective height (SH)	Effective width (SW)	Min. (LW)	Max. (LT)	Min. (LW)	Max. (LT)	Min. (LW)	Max. (LT)	Min. (LW)	Max. (LT)	Fixed
70	1.067	1.422	1.92	2.30	2.69	3.48	3.47	5.05	5.01	9.77	1.43
80	1.219	1.626	2.21	2.64	3.09	3.99	3.98	5.78	5.75	11.19	1.64
90	1.372	1.829	2.49	2.98	3.49	4.51	4.49	6.52	6.48	12.61	1.86
100	1.524	2.032	2.77	3.32	3.88	5.02	4.99	7.26	7.21	14.03	2.08
120	1.829	2.438	3.34	4.00	4.68	6.05	6.01	8.74	8.68	16.87	2.51
150	2.286	3.048	4.19	5.01	5.87	7.58	7.53	10.95	10.87	21.13	3.16
200	3.048	4.064	5.60	6.71	7.85	10.15	10.07	14.64	14.53	28.23	4.24
250	3.810	5.080	7.01	8.40	9.83	12.71	12.61	18.32	18.20	35.33	5.32
300	4.572	6.096	8.43	10.10	11.82	15.28	15.15	22.01	21.86	42.43	6.40
350	5.334	7.112	9.84	11.80	13.80	17.84	17.68	25.70	25.52	49.53	
400	6.096	8.128	11.26	13.49	15.78	20.40	20.22	29.39	29.18	56.64	
500	7.620	10.160	14.08	16.88	19.75	25.53	25.30	36.76	36.50	70.84	
600	9.144	12.192	16.91	20.27	23.72	30.66	30.38	44.14	43.83	85.04	

*: The throw ratio is based on the value during projection onto a 150-inch screen size.

Note

- The projection distances listed here involve an error of $\pm 5\%$.
- When geometric adjustment is used, compensation is made so that the screen size becomes smaller than the specified size.

Setting up

If the projector is used with a screen size not listed in this manual, check the diagonal dimension (inch) of your screen and calculate the projection distance using the following formulas.

■ Calculation formulas for projection distance by lens types (for PT-DZ110XE)

Model number of projection lens	Throw ratio	Aspect ratio	Projection distance (L) formula	Unit : m
Zoom lens	ET-D75LE1	1.4–1.8 : 1	16 : 10	Min. : $L = 0.0298 \times SD (\text{"}) - 0.0760$ Max. : $L = 0.0399 \times SD (\text{"}) - 0.1004$
		1.4–1.8 : 1	16 : 9	Min. : $L = 0.0307 \times SD (\text{"}) - 0.0760$ Max. : $L = 0.0410 \times SD (\text{"}) - 0.1004$
		1.6–2.2 : 1	4 : 3	Min. : $L = 0.0338 \times SD (\text{"}) - 0.0760$ Max. : $L = 0.0451 \times SD (\text{"}) - 0.1004$
	ET-D75LE2	1.8–2.8 : 1	16 : 10	Min. : $L = 0.0400 \times SD (\text{"}) - 0.0795$ Max. : $L = 0.0601 \times SD (\text{"}) - 0.1064$
		1.8–2.8 : 1	16 : 9	Min. : $L = 0.0412 \times SD (\text{"}) - 0.0795$ Max. : $L = 0.0617 \times SD (\text{"}) - 0.1064$
		2.2–3.3 : 1	4 : 3	Min. : $L = 0.0453 \times SD (\text{"}) - 0.0795$ Max. : $L = 0.0680 \times SD (\text{"}) - 0.1064$
	ET-D75LE3	2.8–4.6 : 1	16 : 10	Min. : $L = 0.0601 \times SD (\text{"}) - 0.0958$ Max. : $L = 0.1003 \times SD (\text{"}) - 0.1216$
		2.8–4.6 : 1	16 : 9	Min. : $L = 0.0617 \times SD (\text{"}) - 0.0958$ Max. : $L = 0.1031 \times SD (\text{"}) - 0.1216$
		3.3–5.6 : 1	4 : 3	Min. : $L = 0.0680 \times SD (\text{"}) - 0.0958$ Max. : $L = 0.1136 \times SD (\text{"}) - 0.1216$
	ET-D75LE4	4.6–7.4 : 1	16 : 10	Min. : $L = 0.1003 \times SD (\text{"}) - 0.1158$ Max. : $L = 0.1595 \times SD (\text{"}) - 0.1013$
		4.6–7.4 : 1	16 : 9	Min. : $L = 0.1031 \times SD (\text{"}) - 0.1158$ Max. : $L = 0.1639 \times SD (\text{"}) - 0.1013$
		5.6–8.9 : 1	4 : 3	Min. : $L = 0.1136 \times SD (\text{"}) - 0.1158$ Max. : $L = 0.1806 \times SD (\text{"}) - 0.1013$
	ET-D75LE8	7.3–13.8 : 1	16 : 10	Min. : $L = 0.1595 \times SD (\text{"}) - 0.3862$ Max. : $L = 0.2989 \times SD (\text{"}) - 0.3598$
		7.3–13.8 : 1	16 : 9	Min. : $L = 0.1640 \times SD (\text{"}) - 0.3862$ Max. : $L = 0.3072 \times SD (\text{"}) - 0.3598$
		8.8–16.5 : 1	4 : 3	Min. : $L = 0.1806 \times SD (\text{"}) - 0.3862$ Max. : $L = 0.3383 \times SD (\text{"}) - 0.3598$
	ET-D75LE6	0.9–1.1 : 1	16 : 10	Min. : $L = 0.0201 \times SD (\text{"}) - 0.0566$ Max. : $L = 0.0241 \times SD (\text{"}) - 0.0736$
		0.9–1.1 : 1	16 : 9	Min. : $L = 0.0207 \times SD (\text{"}) - 0.0566$ Max. : $L = 0.0248 \times SD (\text{"}) - 0.0736$
		1.1–1.3 : 1	4 : 3	Min. : $L = 0.0228 \times SD (\text{"}) - 0.0566$ Max. : $L = 0.0273 \times SD (\text{"}) - 0.0736$
	ET-D75LE10	1.3–1.7 : 1	16 : 10	Min. : $L = 0.0284 \times SD (\text{"}) - 0.0857$ Max. : $L = 0.0367 \times SD (\text{"}) - 0.1085$
		1.3–1.7 : 1	16 : 9	Min. : $L = 0.0292 \times SD (\text{"}) - 0.0857$ Max. : $L = 0.0377 \times SD (\text{"}) - 0.1085$
		1.6–2.0 : 1	4 : 3	Min. : $L = 0.0322 \times SD (\text{"}) - 0.0857$ Max. : $L = 0.0416 \times SD (\text{"}) - 0.1085$
	ET-D75LE20	1.7–2.4 : 1	16 : 10	Min. : $L = 0.0364 \times SD (\text{"}) - 0.0832$ Max. : $L = 0.0528 \times SD (\text{"}) - 0.1162$
		1.7–2.4 : 1	16 : 9	Min. : $L = 0.0374 \times SD (\text{"}) - 0.0832$ Max. : $L = 0.0543 \times SD (\text{"}) - 0.1162$
		2.0–2.9 : 1	4 : 3	Min. : $L = 0.0412 \times SD (\text{"}) - 0.0832$ Max. : $L = 0.0598 \times SD (\text{"}) - 0.1162$
ET-D75LE30	2.4–4.7 : 1	16 : 10	Min. : $L = 0.0524 \times SD (\text{"}) - 0.1131$ Max. : $L = 0.1017 \times SD (\text{"}) - 0.1765$	
	2.4–4.7 : 1	16 : 9	Min. : $L = 0.0539 \times SD (\text{"}) - 0.1131$ Max. : $L = 0.1045 \times SD (\text{"}) - 0.1765$	
	2.9–5.6 : 1	4 : 3	Min. : $L = 0.0594 \times SD (\text{"}) - 0.1131$ Max. : $L = 0.1151 \times SD (\text{"}) - 0.1765$	
Fixed-focus lens	ET-D75LE5	0.7 : 1	16 : 10	$L = 0.0154 \times SD (\text{"}) - 0.0835$
		0.7 : 1	16 : 9	$L = 0.0158 \times SD (\text{"}) - 0.0835$
		0.8 : 1	4 : 3	$L = 0.0174 \times SD (\text{"}) - 0.0835$

■ Calculation formulas for projection distance by lens types (for PT-DS100XE)

Model number of projection lens		Throw ratio	Aspect ratio	Projection distance (L) formula	Unit : m
Zoom lens	ET-D75LE1	1.5–2.0 : 1	4 : 3	Min. : $L = 0.0307 \times SD$ (") – 0.0760 Max. : $L = 0.0410 \times SD$ (") – 0.1004	
			16 : 9	Min. : $L = 0.0334 \times SD$ (") – 0.0760 Max. : $L = 0.0446 \times SD$ (") – 0.1004	
	ET-D75LE2	2.0–3.0 : 1	4 : 3	Min. : $L = 0.0412 \times SD$ (") – 0.0795 Max. : $L = 0.0617 \times SD$ (") – 0.1064	
			16 : 9	Min. : $L = 0.0448 \times SD$ (") – 0.0795 Max. : $L = 0.0672 \times SD$ (") – 0.1064	
	ET-D75LE3	3.0–5.0 : 1	4 : 3	Min. : $L = 0.0617 \times SD$ (") – 0.0958 Max. : $L = 0.1031 \times SD$ (") – 0.1216	
			16 : 9	Min. : $L = 0.0672 \times SD$ (") – 0.0958 Max. : $L = 0.1123 \times SD$ (") – 0.1216	
	ET-D75LE4	5.0–8.0 : 1	4 : 3	Min. : $L = 0.1031 \times SD$ (") – 0.1158 Max. : $L = 0.1639 \times SD$ (") – 0.1013	
			16 : 9	Min. : $L = 0.1123 \times SD$ (") – 0.1158 Max. : $L = 0.1786 \times SD$ (") – 0.1013	
	ET-D75LE8	7.9–15.0 : 1	4 : 3	Min. : $L = 0.1640 \times SD$ (") – 0.3862 Max. : $L = 0.3072 \times SD$ (") – 0.3598	
		8.0–15.0 : 1	16 : 9	Min. : $L = 0.1786 \times SD$ (") – 0.3862 Max. : $L = 0.3346 \times SD$ (") – 0.3598	
	ET-D75LE6	1.0–1.2 : 1	4 : 3	Min. : $L = 0.0207 \times SD$ (") – 0.0566 Max. : $L = 0.0248 \times SD$ (") – 0.0736	
			16 : 9	Min. : $L = 0.0225 \times SD$ (") – 0.0566 Max. : $L = 0.0270 \times SD$ (") – 0.0736	
	ET-D75LE10	1.4–1.8 : 1	4 : 3	Min. : $L = 0.0290 \times SD$ (") – 0.0857 Max. : $L = 0.0375 \times SD$ (") – 0.1085	
			16 : 9	Min. : $L = 0.0316 \times SD$ (") – 0.0857 Max. : $L = 0.0409 \times SD$ (") – 0.1085	
	ET-D75LE20	1.8–2.6 : 1	4 : 3	Min. : $L = 0.0371 \times SD$ (") – 0.0832 Max. : $L = 0.0540 \times SD$ (") – 0.1162	
			16 : 9	Min. : $L = 0.0404 \times SD$ (") – 0.0832 Max. : $L = 0.0588 \times SD$ (") – 0.1162	
ET-D75LE30	2.6–5.1 : 1	4 : 3	Min. : $L = 0.0536 \times SD$ (") – 0.1131 Max. : $L = 0.1039 \times SD$ (") – 0.1765		
		16 : 9	Min. : $L = 0.0583 \times SD$ (") – 0.1131 Max. : $L = 0.1132 \times SD$ (") – 0.1765		
Fixed-focus lens	ET-D75LE5	0.8 : 1	4 : 3	$L = 0.0158 \times SD$ (") – 0.0835	
			16 : 9	$L = 0.0172 \times SD$ (") – 0.0835	

Setting up

Calculation formulas for projection distance by lens types (for PT-DW90XE)

Model number of projection lens	Throw ratio	Aspect ratio	Projection distance (L) formula	Unit : m	
Zoom lens	ET-D75LE1	1.5–2.0 : 1	16 : 9	Min. : $L = 0.0343 \times SD$ (") – 0.0760 Max. : $L = 0.0458 \times SD$ (") – 0.1004	
		2.0–2.7 : 1	4 : 3	Min. : $L = 0.0419 \times SD$ (") – 0.0760 Max. : $L = 0.0560 \times SD$ (") – 0.1004	
	ET-D75LE2	2.1–3.1 : 1	16 : 9	Min. : $L = 0.0460 \times SD$ (") – 0.0795 Max. : $L = 0.0689 \times SD$ (") – 0.1064	
		2.7–4.1 : 1	4 : 3	Min. : $L = 0.0563 \times SD$ (") – 0.0795 Max. : $L = 0.0844 \times SD$ (") – 0.1064	
	ET-D75LE3	3.1–5.2 : 1	16 : 9	Min. : $L = 0.0689 \times SD$ (") – 0.0958 Max. : $L = 0.1151 \times SD$ (") – 0.1216	
		4.1–6.9 : 1	4 : 3	Min. : $L = 0.0844 \times SD$ (") – 0.0958 Max. : $L = 0.1409 \times SD$ (") – 0.1216	
	ET-D75LE4	5.2–8.2 : 1	16 : 9	Min. : $L = 0.1151 \times SD$ (") – 0.1158 Max. : $L = 0.1831 \times SD$ (") – 0.1013	
		6.9–11.0 : 1	4 : 3	Min. : $L = 0.1409 \times SD$ (") – 0.1158 Max. : $L = 0.2241 \times SD$ (") – 0.1013	
	ET-D75LE8	8.2–15.4 : 1	16 : 9	Min. : $L = 0.1831 \times SD$ (") – 0.3862 Max. : $L = 0.3430 \times SD$ (") – 0.3598	
		10.9–20.6 : 1	4 : 3	Min. : $L = 0.2241 \times SD$ (") – 0.3862 Max. : $L = 0.4200 \times SD$ (") – 0.3598	
	ET-D75LE6	1.0–1.2 : 1	16 : 9	Min. : $L = 0.0231 \times SD$ (") – 0.0566 Max. : $L = 0.0277 \times SD$ (") – 0.0736	
		1.4–1.6 : 1	4 : 3	Min. : $L = 0.0283 \times SD$ (") – 0.0566 Max. : $L = 0.0339 \times SD$ (") – 0.0736	
	ET-D75LE10	1.4–1.9 : 1	16 : 9	Min. : $L = 0.0324 \times SD$ (") – 0.0857 Max. : $L = 0.0419 \times SD$ (") – 0.1085	
		1.9–2.5 : 1	4 : 3	Min. : $L = 0.0397 \times SD$ (") – 0.0857 Max. : $L = 0.0513 \times SD$ (") – 0.1085	
	ET-D75LE20	1.8–2.7 : 1	16 : 9	Min. : $L = 0.0415 \times SD$ (") – 0.0832 Max. : $L = 0.0602 \times SD$ (") – 0.1162	
		2.5–3.6 : 1	4 : 3	Min. : $L = 0.0508 \times SD$ (") – 0.0832 Max. : $L = 0.0738 \times SD$ (") – 0.1162	
	ET-D75LE30	2.7–5.2 : 1	16 : 9	Min. : $L = 0.0598 \times SD$ (") – 0.1131 Max. : $L = 0.1160 \times SD$ (") – 0.1765	
		3.6–6.9 : 1	4 : 3	Min. : $L = 0.0732 \times SD$ (") – 0.1131 Max. : $L = 0.1420 \times SD$ (") – 0.1765	
	Fixed-focus lens	ET-D75LE5	0.8 : 1	16 : 9	$L = 0.0176 \times SD$ (") – 0.0835
			1.0 : 1	4 : 3	$L = 0.0216 \times SD$ (") – 0.0835

Front leg adjusters and throwing angle

You can screw up/down the front leg adjusters to control the angle of the projector for adjusting the throwing angle.

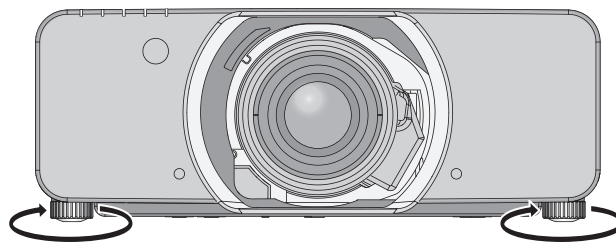

Adjustable range
Front adjuster leg : 50 mm
Rear adjuster leg : 10 mm

Attention

- Heated air comes out of the air exhaust port. Do not touch the air exhaust port directly.

Connections

Before connection to the projector

- Read carefully the instruction manual for the device to be connected.
- Turning off the power switch of the devices before connecting cables.
- If any connection cable is not supplied with the device, or if no optional cable is available for connection of the device, prepare a necessary system connection cable to suit the device.
- Video signals containing too much jitter may cause the images on the screen to randomly wobble or wafure. In this case, a time base corrector (TBC) must be connected.
- The projector accepts the following signals: VIDEO, S-VIDEO, analogue-RGB (with TTL sync. Level) and digital signal.
- Some computer models are not compatible with the projector.
- When using long cables to connect with each of equipment to the projector, there is a possibility that the image will not be output correctly unless a compensator is used.

Pin assignments and signal names of <S-VIDEO IN> terminal

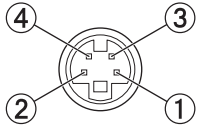
Outside view	Pin No.	Signal names
	①	GND (luminance signal)
	②	GND (color signal)
	③	Luminance signal
	④	Color signal

Pin assignments and signal names of <RGB2 IN> terminal

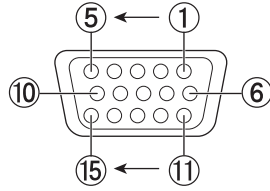
Outside view	Pin No.	Signal names
	①	R/P _R
	②	G/G · SYNC/Y
	③	B/P _B
	⑫	DDC data
	⑬	HD/SYNC
	⑭	VD
	⑮	DDC clock
	④, ⑨	Not assigned
⑤ - ⑧, ⑩, ⑪	GND terminals	

④, ⑨ : Not assigned
⑤ - ⑧, ⑩, ⑪ : GND terminals

Pin assignments and signal names of <HDMI IN> terminal

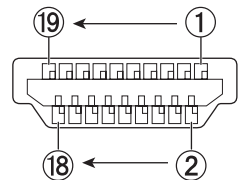
Outside view	Pin No.	Signal names	Pin No.	Signal names
<p>Odd-numbered pins ① to ⑮</p>  <p>Even-numbered pins ② to ⑱</p>	①	T.M.D.S data 2+	②	T.M.D.S data 2 shield
	③	T.M.D.S data 2-	④	T.M.D.S data 1+
	⑤	T.M.D.S data 1 shield	⑥	T.M.D.S data 1-
	⑦	T.M.D.S data 0+	⑧	T.M.D.S data 0 shield
	⑨	T.M.D.S data 0-	⑩	T.M.D.S clock +
	⑪	T.M.D.S clock shield	⑫	T.M.D.S clock -
	⑬	CEC	⑭	—
	⑮	SCL	⑯	SDA
	⑰	DDC/CEC GND	⑱	+5V
	⑲	Hot plug detection		

Connections

Pin assignments and signal names of <DVI-D IN> terminal

Outside view	Pin No.	Signal names	Pin No.	Signal names
	①	T.M.D.S data 2-	⑬	—
	②	T.M.D.S data 2+	⑭	+5V
	③	T.M.D.S data 2/4 shield	⑮	GND
	④	—	⑯	Hot plug detection
	⑤	—	⑰	T.M.D.S data 0-
	⑥	DDC clock	⑱	T.M.D.S data 0+
	⑦	DDC data	⑲	T.M.D.S data 0/5 shield
	⑧	—	⑳	—
	⑨	T.M.D.S data 1-	㉑	—
	⑩	T.M.D.S data 1+	㉒	T.M.D.S clock shield
	⑪	T.M.D.S data 1/3 shield	㉓	T.M.D.S clock +
	⑫	—	㉔	T.M.D.S clock -

Connecting example : AV equipment

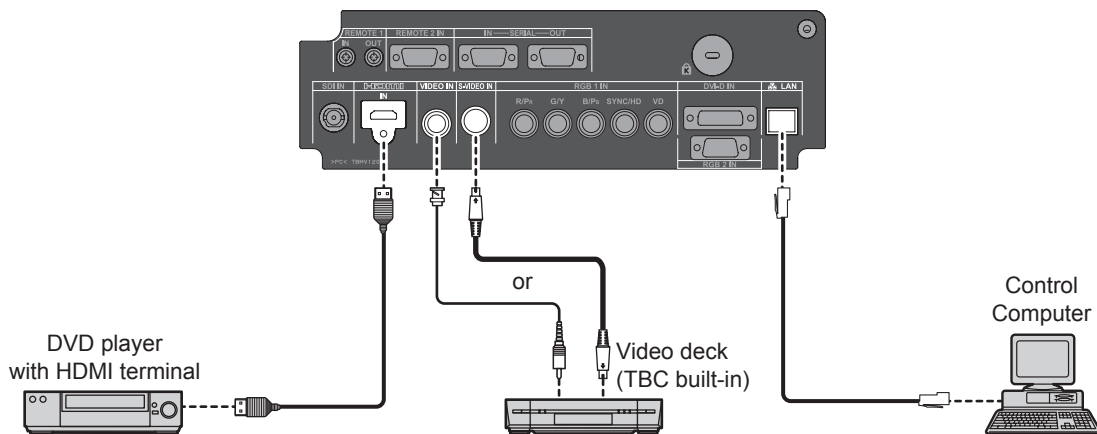

Attention

- When connecting with a video deck, be sure to use the one with a built-in time base corrector (TBC) or use a TBC between the projector and the video deck.
- If nonstandard burst signals are connected, the image may be distorted. If this is the case, connect a TBC between the projector and the video deck.

Note

- When using an HDMI cable, check that it is compliant with the HDMI standard. Using a cable that is not compliant with the HDMI standard may result in problems such as the image cutting out or not appearing. When connecting the 1 080p signal using HDMI, use a cable compliant with 1 080p signal.
- It is possible to connect the HDMI input terminal with an external device having a DVI terminal using an HDMI/DVI conversion cable, but with some devices the images may not appear or other problems may occur. (➡page 74)
- It is possible to connect the DVI-D input terminal with an HDMI- or DVI-D compliant device, but with some devices the images may not appear or other problems may be encountered in operation. (➡page 73)

Connecting example : Computers

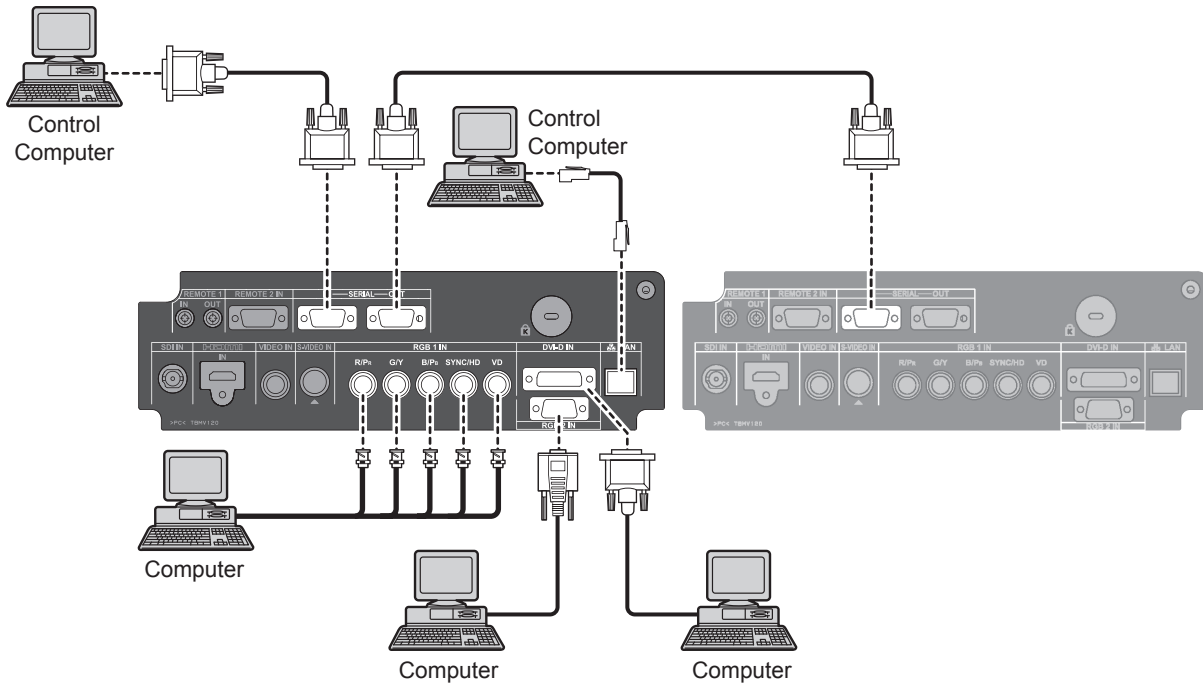

Note

- The DVI-D signal input terminal supports only a single link.
- For the specifications of the RGB signals that can be applied from the PC, refer to “List of compatible signals”. (▶page 123)
- If your computer has the resume feature (last memory), the computer may not function properly until the resume capability is disabled.
- When the SYNC ON GREEN signal is input, do not input sync signals to the SYNC/HD and VD terminals.
- When using the DVI-D input, EDID settings may be required for the connected device. (▶page 73)
- When using an HDMI cable, check that it is compliant with the HDMI standard. Using a cable that is not compliant with the HDMI standard may result in problems such as the image cutting out or not appearing. When connecting the 1 080p signal using HDMI, use a cable compliant with 1 080p signal.
- It is possible to connect the HDMI input terminal with an external device having a DVI terminal using an HDMI/DVI conversion cable, but with some devices the images may not appear or other problems may occur. (▶page 74)

Removing/attaching the projection lens (optional)

Move the lens to the home position before replacing or removing the projection lens. (➔ 44 page)

How to install the projection lens

- 1) Align the mark (orange) on the projection lens with the mark on the projector (○ on the left side of LOCK), then insert the lens and turn it clockwise until there is a click.

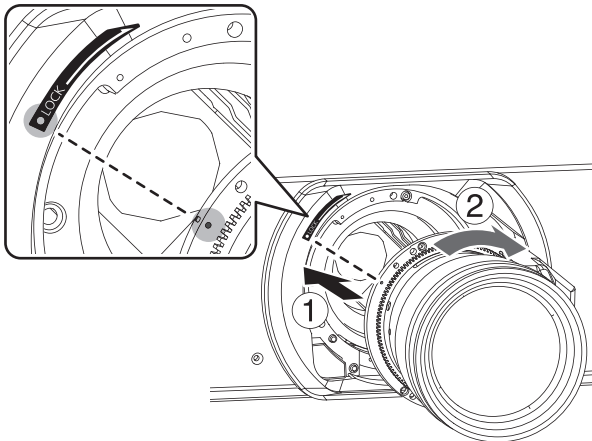

- 2) Fix the projection lens with the attached "Lens fixing screw". *

- Tighten the screw into the first screw hole on the right side of the mark (orange) of the projection lens with a Phillips-head screwdriver. (There is not the projection lens fixing tap hole on all the lenses.)

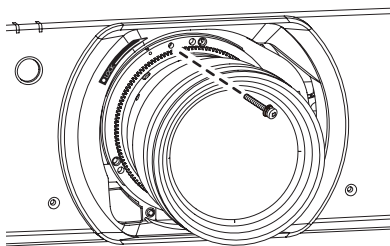

*: Some types of the lens do not have the projection lens fixing screw hole.

Attention

- Do not touch the lens signal receiver. Dust or dirt may cause defective contact.
- Do not touch the surface of the projection lens with your bare hands.
- Store the replaced lens where it will be free from vibration and impact.
- Turn the projection lens counter clockwise to confirm that it does not come out.

How to remove the projection lens

- 1) Remove the "Lens fixing screw". *
 - Remove the first screw on the right side of the mark (orange) of the projection lens with a Phillips-head screwdriver.

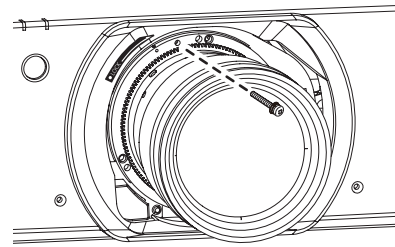

- 2) While holding down the "LOCK button", turn the projection lens counterclockwise, and then pull it off.
 - Turn the projection lens counterclockwise until its mark (orange) is aligned with the mark on the projector (○ on the left side of LOCK).

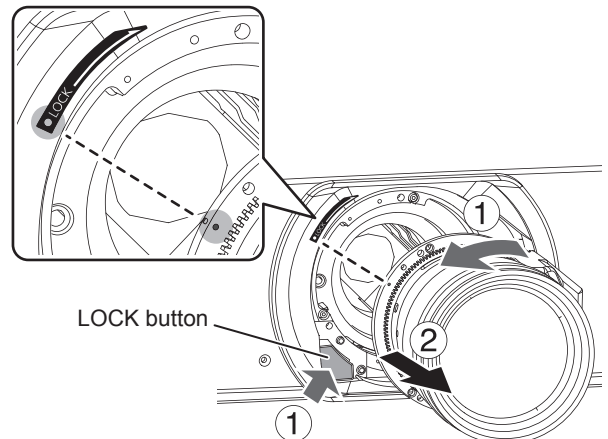

Powering ON/OFF

Connecting the power cord

Be sure to Insert the attached power cord securely to its base to prevent it from coming off.
Before connecting the power cord, confirm that the MAIN POWER switch is in the “○” (OFF) position.

■ Installation

Insert the plug securely until its right and left claw click.

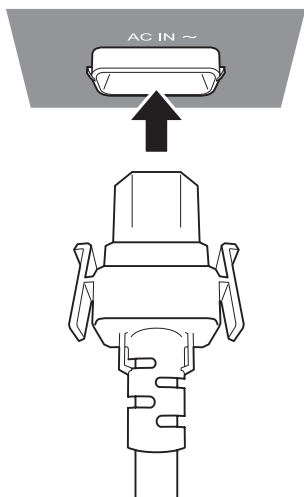

■ Removal

Remove the power cord from the electrical outlet while pressing the knobs on its sides.

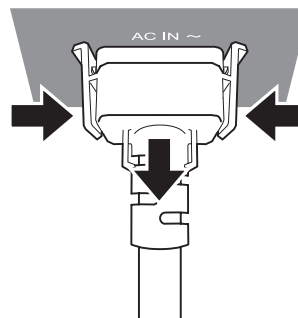

Powering ON/OFF

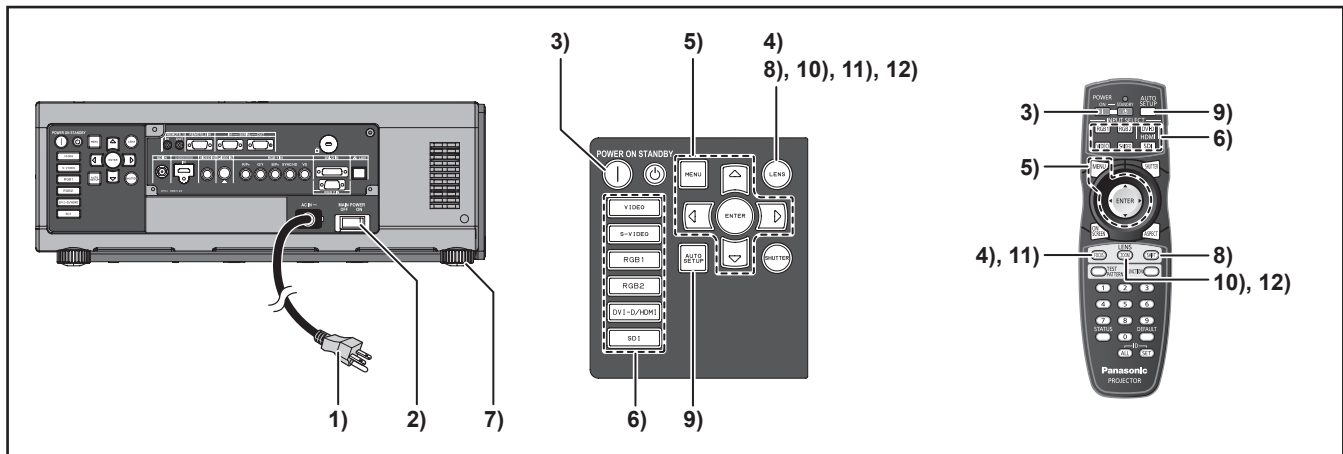

Powering up the projector

When using an optional lens, install a projection lens before switch on the projector. (➔page 38)
Remove the projection lens cover from the lens.

- 1) **Connect the supplied power cable.**
(AC220 V-240V 50Hz/60 Hz)
- 2) **Press the [|] marked side of the MAIN POWER switch to turn on the power.**
The POWER indicator lamp on the projector will flash in red. After a short period, the indicator will illuminate and the projector will enter standby mode.
- 3) **Press POWER ON (|).**
[Power indicator] lamp illuminates in green and soon the image is projected on the screen.

Note

- If the projector is powered up at about 0 °C, a warm-up period of approximately 5 minutes may be necessary to start projection. <TEMP> indicator lamp lights up during the warm-up period. When the warm-up is completed, <TEMP> indicator lamp turns off and the image is projected on the screen.
- If the temperature of the operating environment is low and warm-up takes more than 5 minutes, the projector will judge that a problem has occurred and the power will be turned off automatically. If this happens, increase the temperature around the projector so that it is 0 °C or higher, and then turn on the MAIN POWER switch and the POWER ON (|) switch once more.
- With [ECO] setting in [Standby mode] (➔page 82), When switch on the projector, projection will start about 10 seconds late.
- If the filter is not installed, the power is turned off automatically after 10 minutes.
- If projection was stopped last time by using the DIRECT POWER OFF function, it can be started by setting the MAIN POWER switch to the " I " (ON) position.

Making adjustment and selection

It is recommended that the images are projected continuously for at least 30 minutes before the focus is adjusted.

- 4) **Press <FOCUS> button, roughly adjust the focus of the lens.**
(➔page 42)
- 5) **Select and set the projection scheme of [INSTALLATION] and [COOLING CONDITION] settings in [PROJECTOR SETUP] menu.**
- 6) **Select the input signal by pressing <INPUT SELECT> button (<RGB1>, <RGB2>, <DVI-D/HDMI>, <VIDEO> <S-VIDEO>, <SDI>).**
(SDI: PT-DZ110XE/ PT-DS100XE only)
- 7) **Adjust the tilt of the main unit in front and rear or right and left.**
- 8) **Press <SHIFT> button to adjust the position of the projection.**
- 9) **Press <AUTO SETUP> button if the input signal is RGB signal.**
- 10) **Zoom the lens so the image fills the screen.**
- 11) **Readjust the focus.**
- 12) **Readjust the zoom so that the image size fits in the screen.**

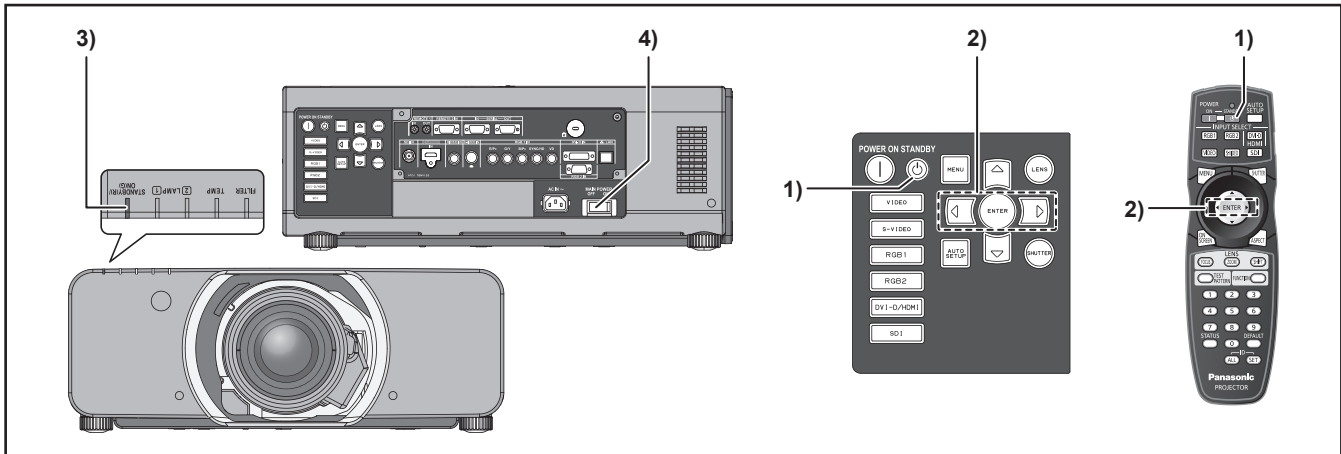

Powering off the projector

- 1) Press **POWER STANDBY** (⏻).
- 2) Press **◀▶** to select **[OK]** and press **(ENTER)**.
(or press **POWER STANDBY** (⏻) again.)
The projection of the image stops, and [Power indicator] lamp of the main unit lights up orange. (The cooling fan keeps running.)
- 3) Wait until the power indicator lamp of the main unit turns to red (i.e., until the cooling fan stops).
- 4) Press the **[○]** marked side of the **(MAIN POWER)** switch to remove all power from the projector.

Note

- In the cooling state after the power is turned off, the lamp will not light up even if the power is turned on. To light up the lamp, turn on the power supply again when the lamp has been cooled sufficiently. Failure to observe this may shorten the lamp life.
- The projector consumes approximately 8 W (240 V mode) power.
(STANDBY MODE: [NORMAL])

Direct power off function

The power supplied internally causes the cooling fan to continue operating and cool off in the event that the power has failed or even after the power cord is accidentally disconnected immediately after the power has been turned off.

Note

- When the lamp has been cooled by the direct power off function, it sometimes takes longer than usual for the lamp to light up again.
- While the cooling fan is operating, do not place the projector inside a box or bag.
- If projection was stopped by using the **DIRECT POWER OFF** function, it can be started by setting the **MAIN POWER** switch to the "I" (ON) position.

Projecting

Check the connections of the peripheral devices, installation of the projection lens (➔page 38), and connection of the power cord (➔page 39) and switch on the power (➔page 40) to start the projector. Select the input signal and adjust the image.

Selecting the input signal

Select an input signal.

The image selected with <INPUT SELECT> button is projected. (➔page 47)

Attention

- Images may not be projected properly depending on the connected device and DVD, video tape, etc. to be played. Select a system format that is suitable for the input signal using the [SYSTEM SELECTOR] in the [PICTURE] menu (➔page 58).
- Check the aspect ratios of the screen and the image and select the optimum aspect ratio using [ASPECT] in the [PICTURE] menu (➔page 59).

How to adjust the focus, zoom and shift

Use the Lens Shift, Zoom, and Focus controls to properly frame the image on the screen.

■ At the projector

1) Press <LENS> button on the control panel.

- Pressing the button changes the setup screen in the order of [FOCUS], [ZOOM] and [SHIFT].

2) Press ▲ ▼ ◀ ▶ to select an item and adjust it.

■ Using the remote control

1) Press <LENS> (FOCUS, ZOOM, SHIFT) button on the remote control.

- Press <FOCUS> button :
Adjust focus.
- Press <ZOOM> button :
Adjust zoom.
- Press <SHIFT> button :
Adjust focus.

2) Press ▲ ▼ ◀ ▶ to select an item and adjust it.

Note

- Be careful not to catch your fingers between the lens and shroud when shifting the lens.
- The zoom adjustment menu will be displayed only when a lens with zoom function is installed.
- When using ET-D75LE5, set the shift to the home position.
- The adjustment can be performed faster by pressing and holding the ▲ ▼ ◀ ▶ for about 7 seconds or more.
- It is recommended that the images are projected continuously for at least 30 minutes before the focus is adjusted.
- If the power is turned off during focus or shift adjustment, the LENS CALIBRATION must be performed when the power is turned on next time.
- If the main power is turned off during focus adjustment, the LENS CALIBRATION will be performed automatically when the focus is adjusted next time.
- If the main power is turned off during shift adjustment, "LENS CALIBRATION ERROR" is displayed when the shift is adjusted next time. Please perform the [LENS CALIBRATION] from the menu (➔page 86)
- If "LENS CALIBRATION ERROR" is still displayed after the LENS CALIBRATION is performed, ask your dealer for repair.

Adjustment range after lens position (optical shift)

Do not move the lens beyond the bounds of the shift range as this may cause a change in the focus. This limitation is to protect the parts of the projector.

Using the standard projection position as the reference, the optical axis shift function makes it possible to adjust the projection position in the ranges shown in the figures below.

Model number of projection lens	Zoom lens	
	ET-D75LE6	ET-D75LE1, ET-D75LE2, ET-D75LE3, ET-D75LE4, ET-D75LE8, ET-D75LE10, ET-D75LE20, ET-D75LE30
PT-DZ110XE		
PT-DS100XE		
PT-DW90XE		

Note

- The ET-D75LE5 has a fixed focal point, and so shift adjustment cannot be carried out.

Projecting

Moving the projection lens position to the home position

- 1) Press and hold <LENS> button on the projector's controls or <SHIFT> button on the remote control for 3 seconds or more.

LENS	
HOME POSITION	
[ENTER]	OK
[MENU]	CANCEL

- 2) Press <ENTER> button while the menu shown above is being displayed. (It will be displayed for about 5 seconds.)
 - [PROGRESS] will appear in the menu, and the projection lens will move to the home position.

Attention

- [HOME POSITION] for the projection lens is the lens position when the lens is being replaced or when the projector is being stored away, and it is not the optical center of the screen.

Lens adjustment to compensate for uneven screen focus

■ About the focus balance

● Relationship between lens orientation and screen focus

If the projection lens is tilted with respect to the plane of the screen, uneven focus will result.

Figure 1 : Illustration of influence of lens orientation

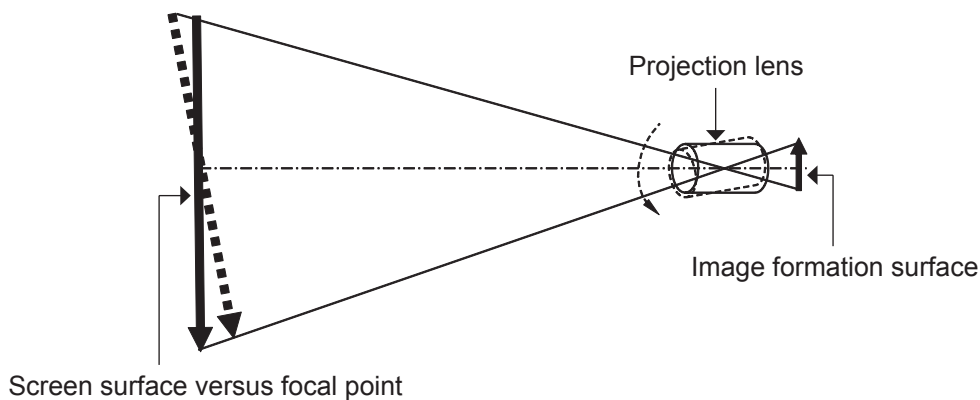

■ Procedure for adjusting the focus balance (tilt compensation in the lens mount)

Three focus adjustment screws on the lens mount may be used to compensate for uneven screen focus.

● Structure of lens mount

The three adjustment screws allow the lens to be tilted up and down, and three more screws lock down the adjustment.

Figure 2 : Front view of lens mount (when viewed from screen side)

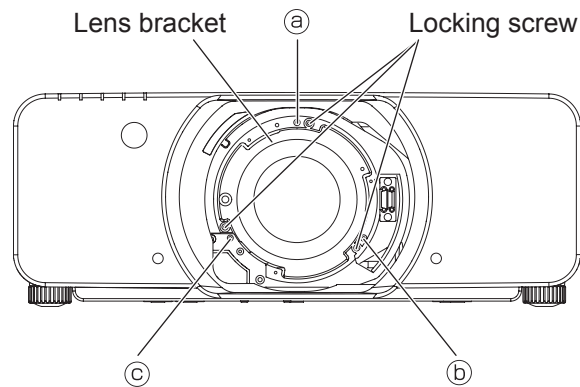

(Adjust the focus adjustment screws (a), (b) and (c) after installing the lens.)

Projecting

If the lens is heavy or the projector is installed so that it is tilted, the lens may be tilted, resulting in the focus becoming unbalanced.

In such a case, refer to the figure 3 and table below, and follow the procedure below to perform adjustment.

● Adjustment procedure

- ① Display the internal test pattern grid, and defocus the image.
- ② Adjust the lens focus till one or more sides of the grid comes into focus. Note the appropriate screws for the out-of-focus sides of the grid as described below.
- ③ Loosen the locking screws for each of the adjustment screws (a), (b) and (c) as needed, following the indications in the example. The screws to be adjusted correspond to the out-of-focus sides of the image.

Attention

- Make adjustments in up to two places, and fully turn the screw clockwise in at least one place.
- ④ Turn the adjustment screws (corresponding to the locking screws loosened in step 3) counterclockwise slightly till the out-of-focus image sides are in focus. (Turning the screws counterclockwise moves the lens bracket and tilts the lens toward the screen.)
 - ⑤ Readjust the lens shift position with the remote if needed.
 - ⑥ Refocus the image as in steps 1 and 2 above. Fine adjust the focus evenness as needed, as described in step 4.
 - ⑦ When adjustment is complete, tighten the locking screws.
 - ⑧ Adjust the Focus.

Tool to be used : Allen hex socket driver or Allen wrench (2.5 mm diagonal hexagon)

An Allen wrench is supplied with the ET-D75LE6 and ET-D75LE8 optional lens.

Figure 3 : Relation between the adjustment place and adjustment screw

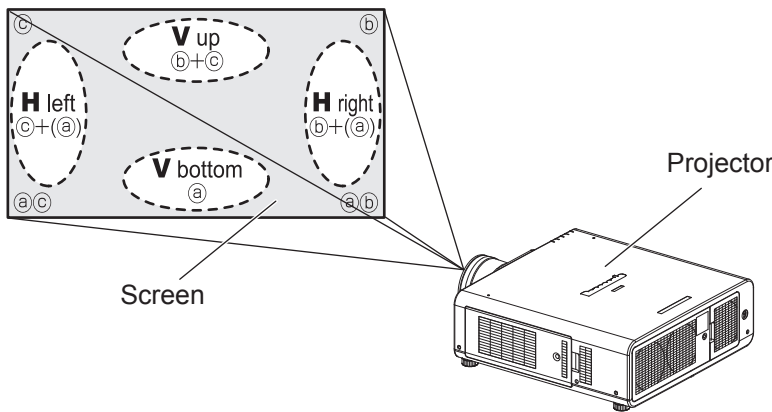

Adjustment place :
The place where the just-in-focus point is at the back.

	When optimal focus point is at the back of screen for V up	When optimal focus point is at the back of screen for V bottom	When optimal focus point is at the back of screen for H left	When optimal focus point is at the back of screen for H right
(a)	Turn counterclockwise	————	————	————
(b)	————	Turn counterclockwise	Turn counterclockwise	————
(c)	————	Turn counterclockwise	————	Turn counterclockwise

Basic operations using the remote control

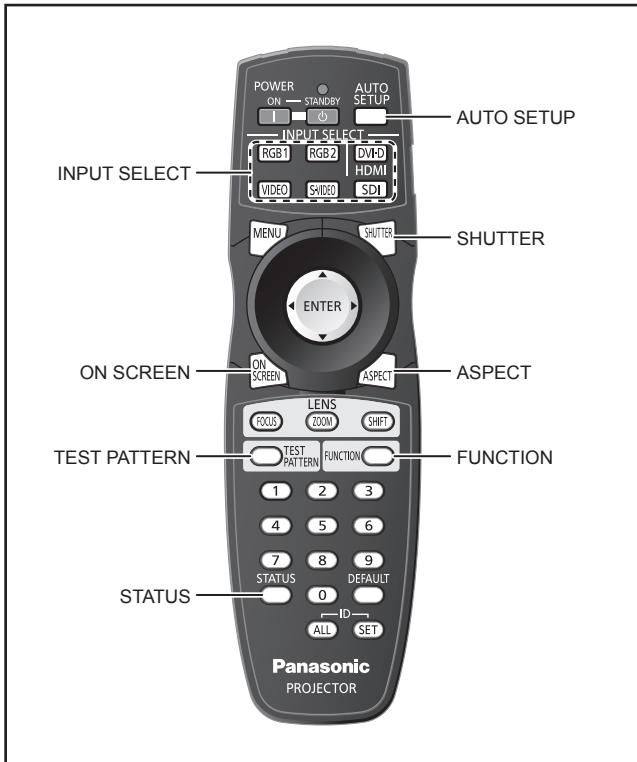

Switching the input signal

You can use the remote control to switch the signals that are being input and projected.

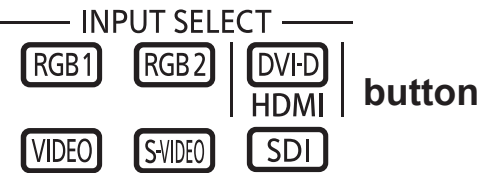

Press <INPUT SELECT> button on the remote control or the main unit.

RGB1	Switches to RGB1 input.
RGB2	Switches to RGB2 input.
DVI-D/ HDMI	Switches to DVI-D or HDMI input. If either of the inputs has already been selected, the input switches to the other.
VIDEO	Switches to VIDEO input.
S-VIDEO	Switches to S-VIDEO input.
SDI *	Switches to SDI input.

*: SDI: PT-DZ110XE/PT-DS100XE only

Using the SHUTTER function

If the projector is not used for a certain period of time during the meeting intermission, for example, a shutter mode is available that allows the user to hide images temporarily.



- 1) Press <SHUTTER> button on the remote control or the main unit.
 - The projected light is blocked by the internal shutter.
- 2) Press <SHUTTER> button again.
 - Projection resumes.

Note

- The power indicator will flash while the SHUTTER function is being used.

On-screen display function

This button electronically mutes the onscreen menus to avoid disrupting the program.



Press <ON SCREEN> button on the remote control.

STATUS function

Pressing this button displays several pages of projector status information.



Press <STATUS> button on the remote control.

- The [STATUS] screen will be displayed.

STATUS		1/3
INPUT	RGB2	
SIGNAL NAME	SXGA60+-A1	
SIGNAL FREQUENCY	65.22k Hz/59.99Hz	
PROJECTOR RUNTIME	1h	
LAMP1	11h / ON /	
LAMP2	1h / ON /	
INTAKE AIR TEMP.	31°C / 87°F	
OPTICS MODULE TEMP.	27°C / 80°F	
AROUND LAMP TEMP.	31°C / 87°F	

Basic operations using the remote control

Automatic adjustment

The automatic setup function can be used to automatically adjust the resolution, clock phase and picture position when analog RGB signals consisting of bitmap images such as computer signals are being input, or to automatically adjust the picture position when DVI-D/HDMI signals are being input.

It is recommended to supply images with a bright white frame at the outermost periphery containing characters etc. that are clear in white and black contrast when the system is in automatic adjustment mode.

Avoid supplying images that involve halftones or gradation such as photographs and computer graphics.



Press <AUTO SETUP> button on the remote control or the main unit.

- A message [COMPLETE] appears if adjustment is ended normally.

Note

- [CLOCK PHASE] may have been shifted even when the adjustment ended normally. In this case, manually adjust the [CLOCK PHASE]. Refer to "CLOCK PHASE" of "POSITION menu" (➔page 61) for details.
- If an image with blurred edges or a dark image is input, [INCOMPLETE] may appear or adjustment may not be performed properly even if [COMPLETE] appears. In this case, manually adjust the items of "INPUT RESOLUTION" of "ADVANCED MENU" (➔page 65), "SHIFT" and "CLOCK PHASE" of "POSITION menu" (➔pages 59, 61).
- For specific signals, adjustment should be made according to "AUTO SETUP" of "DISPLAY OPTION menu" (➔page 72).
- [AUTO SETUP] may not be available depending on the machine type of the personal computer.
- Automatic adjustment may not be available for synchronization signal of C-SYNC and G-SYNC.
- Image may be distorted for several seconds during automatic adjustment. This is not a malfunction.
- For every supplied signal, adjustment is required.
- Automatic adjustment can be canceled by pressing <MENU> button during the course of automatic adjustment.
- Even for an RGB signal for which automatic setup is possible, if automatic setup is performed while moving images are being input, [INCOMPLETE] may appear, or adjustment may not be performed properly even if [COMPLETE] appears.

Using the FUNCTION button

[DISABLE], [SUB MEMORY], [SYSTEM SELECTOR], [SYSTEM DAYLIGHT VIEW], [FREEZE], [P IN P], or [WAVEFORM MONITOR] * operations can be assigned to <FUNCTION> button on the remote control so that it can be used as an easy shortcut button.

FUNCTION button

Press <FUNCTION> button on the remote control.

*: PT-DZ110XE only

Note

- Refer to "FUNCTION BUTTON" of "PROJECTOR SETUP menu" (➔page 85) for details.

Displaying the internal test pattern

The projector has 9 types of internal test patterns to check the condition of the set.

To display test patterns, follow the steps below.

button

- 1) Press <TEST PATTERN> button.
- 2) Press ◀▶ to select [TEST PATTERN].

Note

- Setting is also possible by using an on-screen menu. Refer to "TEST PATTERN menu" (➔page 89) for details.
- Adjustment of the image, picture quality, position, size and other factors will not be reflected in test patterns. Be sure to display an actual input signal before performing these adjustments.

Changing the picture aspect ratio

You can toggle through an appropriate set of aspect ratios for a given input signal.



Press **<ASPECT>** button on the remote control.

- The setting will change as follows each time **<ASPECT>** button is pressed.

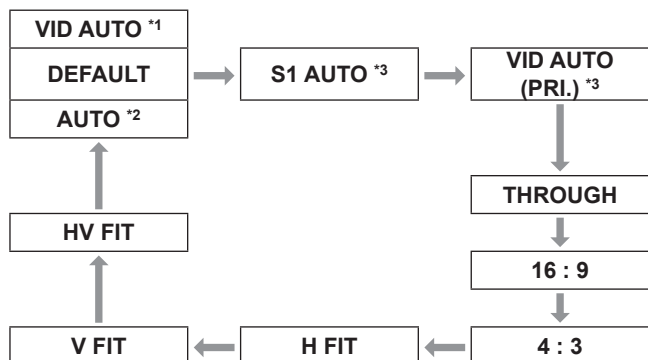

- *1 : VIDEO/S-VIDEO (NTSC) only
- *2 : RGB1/RGB2 (480i, 480p) only
- *3 : S-VIDEO (NTSC) only

Note

- Some aspect ratios may not be available for selection depending on the input signal. Refer to "ASPECT" of "POSITION menu" (➡ page 59) for details.

Menu Navigation

Menus are extensively used for configuring, adjusting or reconfiguring the projector.

Navigating through the menu

Operating procedure

1) Press <MENU> button.

[MAIN MENU] appears on the screen.

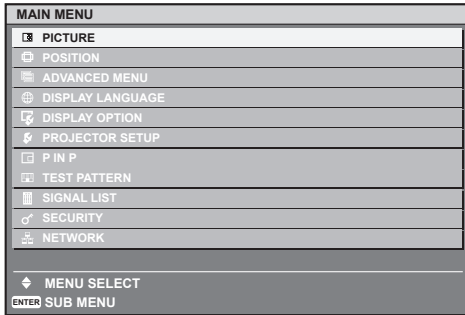

2) Press ▲▼ to select the desired item.

The selected item is highlighted in orange.

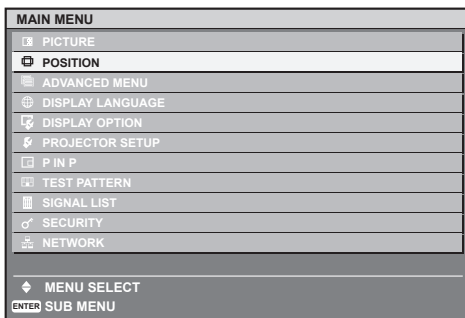

3) Press <ENTER> button to establish your selection.

The submenu for the selected option will now open.

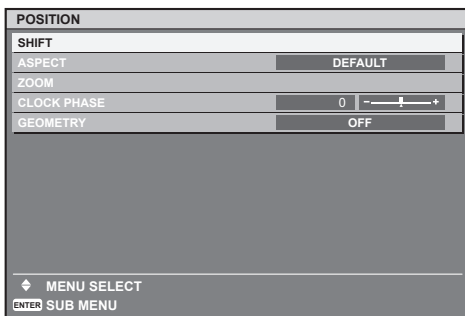

4) Press ▲▼ button to highlight the desired adjustment item, then press ◀▶ to change or adjust the parameter value.

For some items, an individual adjustment screen containing a bar scale will appear as shown in the diagram below when ◀▶ is pressed.



Note

- Press <MENU> button to return to the previous menu.
- Some menu items may not be valid for certain signal formats applied to the projector. The menu items that cannot be adjusted or used are shown in gray characters, and they cannot be selected.
- If no button is pressed for approx. 5 seconds while the individual adjustment screen is displayed, the screen will return to the previous page.

Resetting to the factory default

If an adjustment item is selected and <DEFAULT> button is pressed, the adjustment value will return to the factory default setting.

Press **DEFAULT**



Note



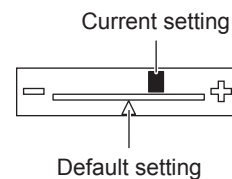







- You cannot reset all the settings at a time to the factory default settings. To reset all the settings to the factory defaults, refer to "INITIALIZE" of "PROJECTOR SETUP menu" (➔ 87 page).
- Some menu items are not available to reset by pressing <DEFAULT> button. Adjust each menu item manually.
- The triangle mark under the bar indicates factory default setting and the square indicates the current setting. The triangle mark position varies by the selected input signals.



MAIN MENU

The main menu consists of the following 11 menu items.

When a main menu item is selected, the screen changes to a sub-menu selection screen.

	PICTURE
	POSITION
	ADVANCED MENU
	DISPLAY LANGUAGE
	DISPLAY OPTION
	PROJECTOR SETUP
	P IN P
	TEST PATTERN
	SIGNAL LIST
	SECURITY
	NETWORK

SUB MENU

The sub-menu screen of the selected main menu appears, and you can set and adjust the various items in the sub-menu.

PICTURE []

Sub-menu item	Default	Page
PICTURE MODE	STANDARD	53
CONTRAST	0	54
BRIGHTNESS	0	54
COLOR	0	54
TINT	0	54
COLOR TEMPERATURE	DEFAULT	55
GAMMA	DEFAULT	56
SYSTEM DAYLIGHT VIEW	OFF	56
SHARPNESS	6	57
NOISE REDUCTION	2	57
DYNAMIC IRIS	2	57
SYSTEM SELECTOR	YP _B PR ^{*1}	58

Note

- The factory default values may vary depending on the PICTURE MODE.

POSITION []

Sub-menu item	Default	Page
SHIFT	—	59
ASPECT	DEFAULT ^{*1}	59
ZOOM	—	60
CLOCK PHASE	32	61
GEOMETRY ^{*2}	OFF	61
KEystone ^{*3}	—	63

ADVANCED MENU []

Sub-menu item	Default	Page
DIGITAL CINEMA REALITY	AUTO ^{*1}	64
BLANKING	—	64
INPUT RESOLUTION	—	65
CLAMP POSITION	24 ^{*1}	65
EDGE BLENDING	OFF	65
FRAME DELAY	DEFAULT	67
RASTER POSITION	—	67

Menu Navigation

■ DISPLAY LANGUAGE []

Details (➔page 68)

■ DISPLAY OPTION []

Sub-menu item	Default	Page
COLOR MATCHING	OFF	69
LARGE SCREEN CORRECTION	OFF	70
SCREEN SETTING *2	—	70
WAVEFORM MONITOR *4	OFF	71
AUTO SIGNAL	OFF	72
AUTO SETUP	—	72
RGB IN	—	73
DVI-D IN	—	73
HDMI IN	—	74
SDI IN *2	—	74
ON-SCREEN DISPLAY	—	74
BACK COLOR	BLUE	75
STARTUP LOGO	LOGO2	75
FREEZE	—	75

■ PROJECTOR SETUP []

Sub-menu item	Default	Page
PROJECTOR ID	ALL	76
INSTALLATION	FRONT/ FLOOR	76
HIGH ALTITUDE MODE	OFF	76
COOLING CONDITION	FLOOR SETTING	77
LAMP SELECT	DUAL	77
LAMP RELAY	OFF	77
LAMP POWER	HIGH	78
BRIGHTNESS CONTROL	—	78
STANDBY MODE	NORMAL	82
SCHEDULE	OFF	82
RS-232C	—	83
STATUS	—	84
NO SIGNAL SHUT-OFF	DISABLE	85
REMOTE2 MODE	DEFAULT	85
FUNCTION BUTTON	—	85
DATE AND TIME	—	85
LENS CALIBRATION	—	86
FILTER COUNTER RESET	—	86
SAVE ALL USER DATA	—	87
LOAD ALL USER DATA	—	87
INITIALIZE	—	87
SERVICE PASSWORD	—	87

■ P IN P []

Details (➔page 88)

■ TEST PATTERN []

Details (➔page 89)

■ SIGNAL LIST []

Details (➔page 90)

■ SECURITY []

Sub-menu item	Default	Page
SECURITY PASSWORD	OFF	92
SECURITY PASSWORD CHANGE	—	92
DISPLAY SETTING	OFF	93
TEXT CHANGE	—	93
MENU LOCK	OFF	93
MENU LOCK PASSWORD	—	93
CONTROL DEVICE SETUP	—	94

■ NETWORK []

Sub-menu item	Default	Page
NETWORK SETUP	—	95
NETWORK CONTROL	—	95
NETWORK STATUS	—	95

Note

- Some default settings vary by the selected input signal.
- Sub-menu items vary according to the selected input signal.

*1 : Some default settings vary by the selected input signal.

*2 : PT-DZ110XE/PT-DS100XE only

*3 : PT-DW90XE only

*4 : PT-DZ110XE only

PICTURE menu

- See “Navigating through the menu” (➔page 50).
- See “MAIN MENU” and “SUB MENU” (➔page 51).

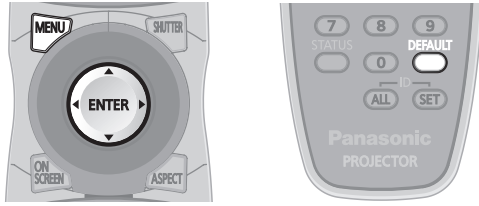

PICTURE MODE

The user can switch to the desired picture mode suitable for the image source and the environment in which this projector is used.

- 1) Press ▲▼ to select [PICTURE MODE].
- 2) Press ◀▶ to switch [PICTURE MODE].
 - The setting will change as follows each time ◀▶ is pressed.



STANDARD	The picture becomes suitable for moving images in general.
CINEMA	The picture becomes suitable for movie sources.
NATURAL	The picture complies with sRGB.
DICOM SIM.	The picture becomes similar to DICOM Part14 gray scale.
DYNAMIC	The light output is maximized for use in bright areas.
GRAPHIC	The picture becomes suitable for input from the personal computer.
USER	You can set your favorite picture mode.

Note

- Factory defaults are [GRAPHIC] for RGB system and [STANDARD] for moving images.
- DICOM is an abbreviation for “Digital Imaging and Communication in Medicine”, which is a standard for medical imaging devices. Although the name “DICOM” is used, this projector is not a medical device. Accordingly, do not use the projected images for medical diagnosis or similar usage.
- When <ENTER> button is pressed while a [PICTURE MODE] other than [USER] is selected, the setting is saved and will be used as the preset value next time a signal is inputted. At this time, all the data except [SYSTEM SELECTOR] in the [PICTURE] menu are saved.
- The factory default of [USER] is the image conformed to ITU-R BT.709 Standard.

Changing the name of [USER]

1. Select [USER] in step 2).
2. Press <ENTER> button.
 - A screen showing details of the [PICTURE MODE] will be displayed.
3. Press ▲▼ to select [PICTURE MODE NAME CHANGE].
4. Press <ENTER> button.
 - The [PICTURE MODE NAME CHANGE] screen will be displayed.

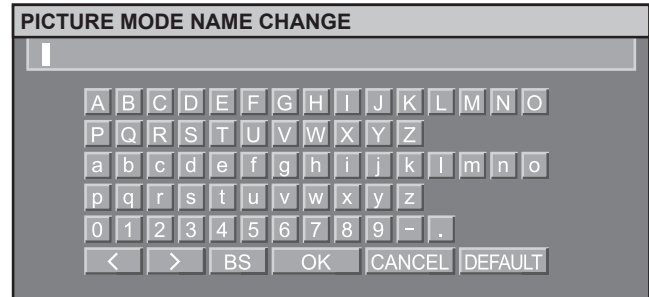

- 5) Press ▲▼◀▶ to select characters and press <ENTER> button to input them.
6. Press ▲▼◀▶ to select [OK], and press <ENTER> button.
 - The picture mode name is changed.

PICTURE menu

CONTRAST

You can adjust the contrast of the projected image.

- 1) Press ▲▼ to select [CONTRAST].
- 2) Press ◀▶ or <ENTER> button.
 - The [CONTRAST] individual adjustment screen will be displayed.
- 3) Press ◀▶ to adjust the level.

Operation	Adjustment	Adjustment range
Press ▶.	Raises the picture brightness and the picture becomes clearer.	Maximum value 31
Press ◀.	Lowers the picture brightness and weakens the picture.	Minimum value -31

Attention

- Adjust the BRIGHTNESS in advance if necessary.

BRIGHTNESS

You can adjust the brightness of the projected image.

- 1) Press ▲▼ to select [BRIGHTNESS].
- 2) Press ◀▶ or <ENTER> button.
 - The [BRIGHTNESS] individual adjustment screen will be displayed.
- 3) Press ◀▶ to adjust the level.

Operation	Adjustment	Adjustment range
Press ▶.	Increases the brightness of the dark (black) parts of the screen.	Maximum value 31
Press ◀.	Reduces the brightness of the dark (black) parts of the screen.	Minimum value -31

COLOR

You can adjust the color saturation of the projected image.

- 1) Press ▲▼ to select [COLOR].
- 2) Press ◀▶ or <ENTER> button.
 - The [COLOR] individual adjustment screen will be displayed.
- 3) Press ◀▶ to adjust the level.

Operation	Adjustment	Adjustment range
Press ▶.	Deepens colors.	Maximum value 31
Press ◀.	Weakens colors.	Minimum value -31

TINT

You can adjust the skin tone in the projected image.

- 1) Press ▲▼ to select [TINT].
- 2) Press ◀▶ or <ENTER> button.
 - The [TINT] individual adjustment screen will be displayed.
- 3) Press ◀▶ to adjust the level.

Operation	Adjustment	Adjustment range
Press ▶.	Adjusts skin tone toward greenish color.	Maximum value 31
Press ◀.	Adjusts skin tone toward reddish-purple.	Minimum value -31

COLOR TEMPERATURE

You can adjust the white balance of the projected image.

- 1) Press ▲▼ to select [COLOR TEMPERATURE].
- 2) Press ◀▶ or <ENTER> button.
 - The [COLOR TEMPERATURE] individual adjustment screen will be displayed.
- 3) Press ◀▶ to switch [COLOR TEMPERATURE].
 - The setting will change as follows each time ◀▶ is pressed.

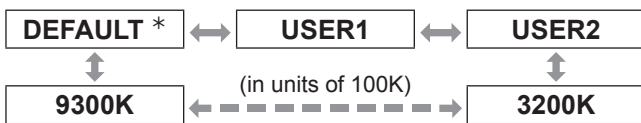

*: [DEFAULT] cannot be selected when the [PICTURE MODE] has been set to [USER] or [DICOM SIM.].

Note

- When any setting other than [OFF] has been selected for [COLOR MATCHING] (➔page 69), the [COLOR TEMPERATURE] setting is fixed to [USER1].
- The value of color temperature is for reference only.

To further adjust toward the desired white balance

- 4) Select [USER1] or [USER2] in Step 3).
- 5) Press <ENTER> button.
 - The [COLOR TEMPERATURE] screen will be displayed.
- 6) Press ▲▼ to select [WHITE BALANCE].
- 7) Press <ENTER> button.
 - The [WHITE BALANCE] screen will be displayed.
- 8) Press ▲▼ to select [WHITE BALANCE HIGH] or [WHITE BALANCE LOW].
- 9) Press <ENTER> button.
 - The [WHITE BALANCE HIGH (or LOW)] screen will be displayed.
- 10) Press ▲▼ to select [RED], [GREEN] or [BLUE].

11) Press ◀▶ to adjust the level.

Item	Operation	Adjustment	Adjustment range
RED	Press ▶.	Deepens red.	Maximum value HIGH : 255 LOW : 127
	Press ◀.	Weakens red.	
GREEN	Press ▶.	Deepens green.	Minimum value HIGH : 0 LOW : -127
	Press ◀.	Weakens green.	
BLUE	Press ▶.	Deepens blue.	Default HIGH : 255 LOW : 0
	Press ◀.	Weakens blue.	

Note

- All colors will not be displayed properly unless adequate adjustment is made. If the adjustment does not look suitable, you can press <DEFAULT> button to return the setting for the selected item only to the factory default setting.
- The [COLOR TEMPERATURE] cannot be adjusted for the internal test pattern (➔page 89). Be sure to project the input signal when adjusting the [COLOR TEMPERATURE].

Changing the name of [USER 1] or [USER 2]

1. Select [USER1] or [USER2] in step 3).
2. Press <ENTER> button.
 - The [COLOR TEMPERATURE] screen will be displayed.
3. Press ▲▼ to select [COLOR TEMPERATURE NAME CHANGE].
4. Press <ENTER> button.
 - The [COLOR TEMPERATURE NAME CHANGE] screen will be displayed.

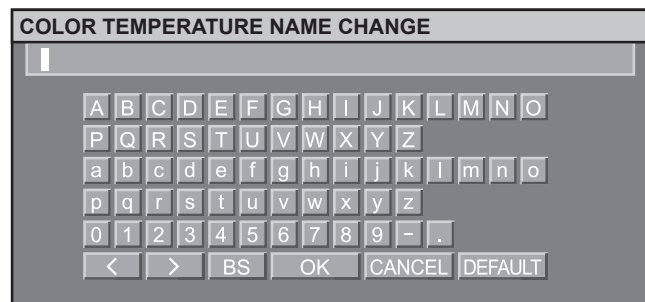

PICTURE menu

- 5) Press **▲▼◀▶** to select characters and press **<ENTER>** button to input them.
6. Press **▲▼◀▶** to select **[OK]**, and press **<ENTER>** button.
 - The color temperature setting name is changed.

GAMMA

This switches the gamma mode.

- 1) Press **▲▼** to select **[GAMMA]**.
- 2) Press **◀▶** or **<ENTER>** button.
 - The **[GAMMA]** individual adjustment screen will be displayed.
- 3) Press **◀▶** to switch **[GAMMA]**.
 - The setting will change as follows each time **◀▶** is pressed.

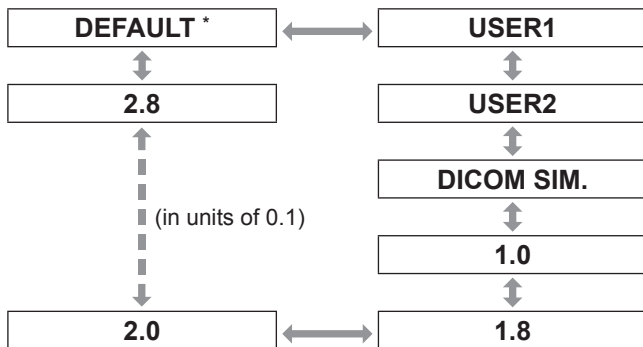

*: **[DEFAULT]** cannot be selected when the **[PICTURE MODE]** has been set to **[DYNAMIC]**, **[USER]** or **[DICOM SIM.]**.

Note

- DICOM is an abbreviation for "Digital Imaging and Communication in Medicine", which is a standard for medical imaging devices. This projector is not a medical device. Do not use the displayed image for diagnosis.

Changing the name of **[USER1]** or **[USER2]**

1. Select **[USER1]** or **[USER2]** in step 3).
2. Press **<ENTER>** button.
 - The **[GAMMA]** screen will be displayed.
3. Press **▲▼** to select **[GAMMA NAME CHANGE]**.
4. Press **<ENTER>** button.
 - The **[GAMMA NAME CHANGE]** screen will be displayed.

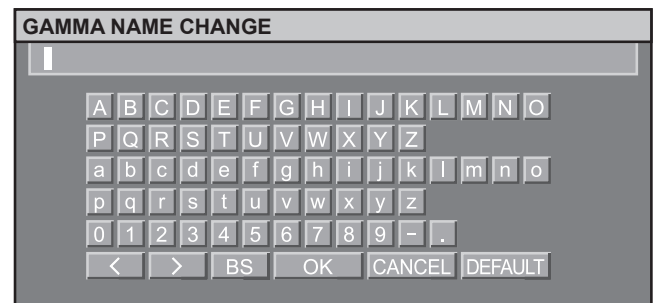

- 5) Press **▲▼◀▶** to select characters and press **<ENTER>** button to input them.
6. Press **▲▼◀▶** to select **[OK]**, and press **<ENTER>** button.
 - The gamma selection name is changed.

SYSTEM DAYLIGHT VIEW

This corrects images so that they appear vivid when projected under bright lighting.

- 1) Press **▲▼** to select **[SYSTEM DAYLIGHT VIEW]**.
- 2) Press **◀▶** or **<ENTER>** button.
 - The **[SYSTEM DAYLIGHT VIEW]** individual adjustment screen will be displayed.
- 3) Press **◀▶** to switch **[SYSTEM DAYLIGHT VIEW]**.
 - The setting will change as follows each time **◀▶** is pressed.

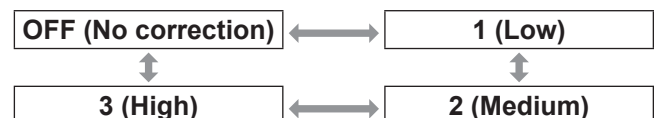

SHARPNESS

This adjusts the sharpness of the pictures.

- 1) Press ▲▼ to select [SHARPNESS].
- 2) Press ◀▶ or <ENTER> button.
 - The [SHARPNESS] individual adjustment screen will be displayed.
- 3) Press ◀▶ to adjust the level.

Operation	Adjustment	Adjustment range
Press ▶.	Contours become sharper.	0 - 15
Press ◀.	Contours become softer.	

NOISE REDUCTION

This can be used to adjust pictures if they contain interference as a result of poor quality of the input signal.

- 1) Press ▲▼ to select [NOISE REDUCTION].
- 2) Press ◀▶ or <ENTER> button.
 - The [NOISE REDUCTION] individual adjustment screen will be displayed.
- 3) Press ◀▶ to switch [NOISE REDUCTION].
 - The setting will change as follows each time ◀▶ is pressed.

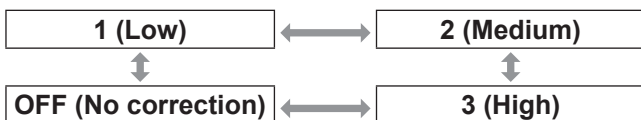

Attention

- [NOISE REDUCTION] is set active when the selected input signal has less noise. Applying noise reduction may affect the image quality, if so, set to [OFF].

DYNAMIC IRIS

Pictures with the optimum contrast will be displayed by automatically providing aperture compensation and signal compensation to suit the pictures concerned.

- 1) Press ▲▼ to select [DYNAMIC IRIS].
- 2) Press ◀▶ or <ENTER> button.
 - The [DYNAMIC IRIS] individual adjustment screen will be displayed.

- 3) Press ◀▶ to switch [DYNAMIC IRIS].
 - The setting will change as follows each time ◀▶ is pressed.

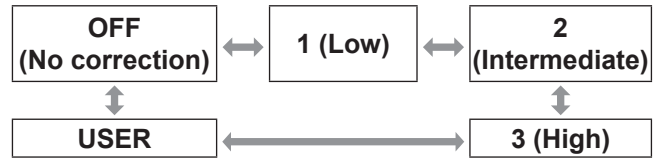

To further adjust the selected compensation amount

- 4) Select [USER] in step 3).
- 5) Press <ENTER> button.
 - The [DYNAMIC IRIS] screen will be displayed.
- 6) Press ▲▼ to select the item to be adjusted, and press ◀▶ to adjust the amount of correction.

● AUTO IRIS (Automatic aperture adjustment)

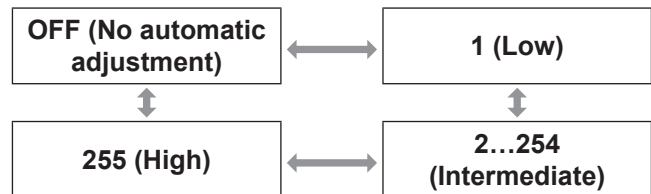

● MANUAL IRIS (Fixed aperture adjustment)

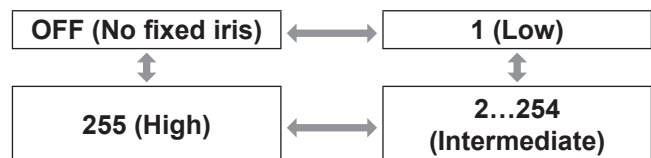

● DYNAMIC GAMMA (signal compensation amount adjustment)

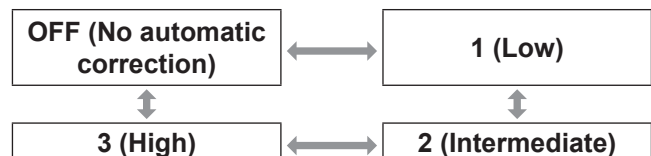

Note

- The contrast is set to the maximum level when [DYNAMIC IRIS] is set to [3].

PICTURE menu

SYSTEM SELECTOR

This enables the projector to automatically recognize input signals. Furthermore, if unstable signals are input, the system format can be selected manually.

- 1) Press ▲ ▼ to select [SYSTEM SELECTOR].
- 2) Press <ENTER> button.
- 3) Press ▲ ▼ to switch [SYSTEM SELECTOR].
- 4) Press <ENTER> button.

VIDEO/S-VIDEO terminal input signal

Select from AUTO, NTSC, NTSC4.43, PAL, PAL-M, PAL-N, SECAM, and PAL60.

Attention

- [AUTO] mode is selected by default.
- When the projector is not working properly in [AUTO] mode, change the setting according to each SYSTEM SELECTOR type.

Note

- [AUTO] automatically selects from NTSC, NTSC4.43, PAL, PAL-M, PAL-N, SECAM, and PAL60.

RGB1/RGB2 terminal input signal

- 480i, 576i, 576p signals
Select from RGB and YC_BCR.
- VGA60, 480p signals
Select from VGA60, 480p, and 480pRGB.
- Other signals
Select from RGB and YP_BPR.

Note

- Refer to "List of compatible signals" (➔page 123) for available signals.

DVI-D terminal input signal

- 480p, 576p signals
Select from RGB and YC_BCR.
- Other signals
Select from RGB and YP_BPR.

Note

- Refer to "List of compatible signals" (➔page 123) for available signals.
- Malfunction may occur or other problems could be encountered with some equipment.

HDMI terminal input signal

- 480p, 576p signals
Select from Auto, RGB, and YC_BCR.
- Other signals
Select from Auto, RGB, and YP_BPR

Note

- Refer to "List of compatible signals" (➔page 123) for available signals.
- Malfunction may occur or other problems could be encountered with some equipment.

SDI terminal input signal

(PT-DZ110XE/PT-DS100XE only)

- Select from AUTO, 1 080/60i, 1 035/60i, 720/60p, 1 080/24p, 1 080/50i, 1 080/30p, 1 080/25p, 1 080/24sF, 720/50p, 480i, and 576i.
- Refer to "List of compatible signals" (➔page 123) for available signals.

To display pictures complying with the sRGB standard

sRGB is the international color reproduction standard (IEC61966-2-1) established by IEC (International Electrotechnical Commission).

To reproduce colors more faithfully in compliance with the sRGB standard, perform the following setting procedure.

- 1) Set [COLOR MATCHING] adjustment to [OFF].
 - Refer to "COLOR MATCHING" (➔page 69).
- 2) Display the [PICTURE] screen.
 - Refer to "PICTURE menu" (➔page 53).
- 3) Press ▲ ▼ to select [PICTURE MODE].
- 4) Press ◀▶ to select [NATURAL].
- 5) Press ▲ ▼ to select [COLOR].
- 6) Press <DEFAULT> button on the remote control to restore the factory default.
- 7) Follow the same procedure (steps 5-6) to restore the factory default for [TINT], [COLOR TEMPERATURE] and [GAMMA].

Note

- sRGB is only enable when RGB signals are being input.

POSITION menu

- See “Navigating through the menu” (➔page 50).
- See “MAIN MENU” and “SUB MENU” (➔page 51).

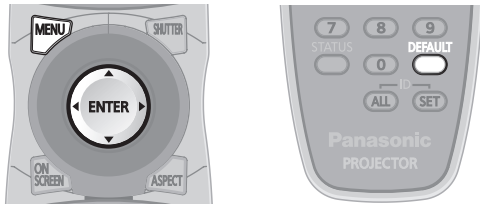

SHIFT

This function allows the user to adjust the raster position vertically or horizontally if the position of the image projected on the screen is displaced even when the projector is properly aligned with the screen, and the internal test patterns are correctly framed.

- 1) Press ▲▼ to select [SHIFT].
- 2) Press <ENTER> button.
 - The [SHIFT] screen will be displayed.
- 3) Press ▲▼◀▶ to adjust the position.

■ For vertical (up and down) adjustment

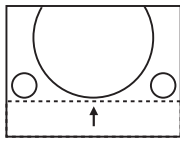
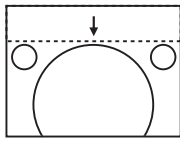
Operation	Adjustment
Press ▲.	The picture position moves up. 
Press ▼.	The picture position moves down. 

■ For horizontal (right and left) adjustment

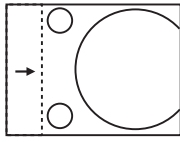
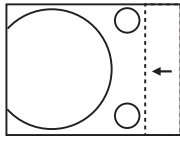
Operation	Adjustment
Press ▶.	The picture position moves to the right. 
Press ◀.	The picture position moves to the left. 

ASPECT

This changes the aspect ratio of the projected image. This changes the aspect ratio for the screen range selected with [SCREEN SETTING]. Set [SCREEN SETTING] first. (➔page 70)

- 1) Press ▲▼ to select [ASPECT].
- 2) Press ◀▶ or <ENTER> button.
 - The [ASPECT] individual adjustment screen will be displayed.
- 3) Press ◀▶ to switch [ASPECT].
 - The setting will change as follows each time ◀▶ is pressed.

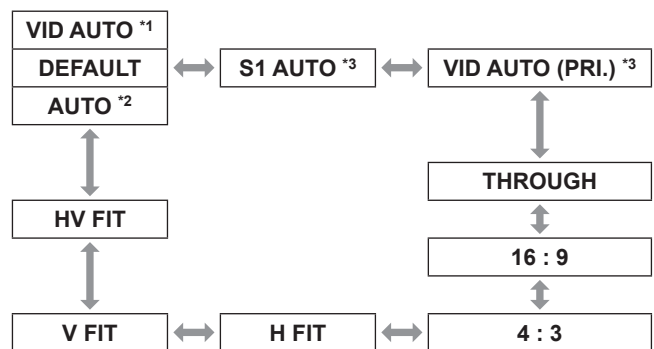

- *1 : VIDEO/S-VIDEO (NTSC) only
- *2 : RGB1/RGB2 (480i, 480p) only
- *3 : S-VIDEO (NTSC) only

■ DEFAULT

Pictures are displayed without changing the aspect ratio of the input signals.

■ VID AUTO

The projector identifies the video ID (VID) embedded in the picture signals and displays the picture by automatically switching the screen sizes between 4 : 3 and 16 : 9. This function is effective for the NTSC signal input.

■ AUTO

The projector identifies the video ID (VID) embedded in the picture signals and displays the picture by automatically switching the screen sizes between 4 : 3 and 16 : 9. This function is effective for the 480i/480p signal input.

■ S1 AUTO

The projector identifies the S1 signal and displays the picture by automatically switching the screen sizes between 4 : 3 and 16 : 9. This function is effective for S-VIDEO NTSC signals.

POSITION menu

VID AUTO (PRI.)

The projector identifies the abovementioned VID or S1 signals and displays the picture by automatically choosing the screen sizes of 4 : 3 or 16 : 9 according to the VID if it is detected or S1 signals if a VID is not detected. This function is effective for S-Video NTSC signals.

THROUGH

Pictures are displayed without changing the resolution of the input signals.

16 : 9

When standard signals ^{*4} are input, the pictures are displayed with the aspect ratio converted to 16 : 9. When wide signals are input ^{*5}, the pictures are displayed without changing the aspect ratio.

4 : 3

When standard signals ^{*4} are input, the pictures are displayed without changing the aspect ratio. When wide signals are input ^{*5} and [4:3] is selected with [SCREEN FORMAT], the aspect ratio is changed to 4:3. If [4:3] is not selected with [SCREEN FORMAT], the pictures are reduced so that they will be in the 4:3 screen without changing the input aspect ratio.

H FIT

The display will use the full width of the screen range selected with [SCREEN FORMAT]. When signals have a vertical aspect ratio that is larger than the screen aspect selected with [SCREEN FORMAT], the pictures will be displayed with their bottom areas cut off.

V FIT

The display will use the full height of the screen range selected with [SCREEN FORMAT].

HV FIT

The pictures are displayed in the full screen range selected with [SCREEN FORMAT]. If the aspect ratios of the input signals and screen range differ, conversion to the screen aspect set with [SCREEN FORMAT] is performed and then the pictures are displayed.

*4 : Standard signals are input signals with an aspect ratio of 4 : 3 or 5 : 4.

*5 : Wide-screen signals are input signals with an aspect ratio of 16:10, 16 : 9, 15 : 9 or 15 : 10.

Note

- Some size modes are not available for certain types of input signals. For NTSC signals, [DEFAULT] cannot be selected.
- If an aspect ratio which is different from the aspect ratio for the input signals is selected, the pictures will appear differently from the originals. Be careful of this when selecting the aspect ratio.
- If using this projector in places such as cafes or hotels to display programs for a commercial purpose or for public presentation, note that adjusting the aspect ratio or using the zoom function to change the screen pictures may be an infringement of the rights of the original copyright owner for that program under copyright protection laws.
- If conventional (normal) 4 : 3 pictures which are not wide-screen pictures are displayed on a wide screen, the edges of the pictures may not be visible or they may become distorted. Such pictures should be viewed as with an aspect ratio of 4 : 3 in the original format intended by the creator of the pictures.

ZOOM

This adjusts the size of the projected pictures.

- 1) Press ▲ ▼ to select [ZOOM].
- 2) Press <ENTER> button.
 - The [ZOOM] screen will be displayed.
- 3) Press ▲ ▼ to select [VERTICAL]/ [HORIZONTAL], and press ◀ ▶ to adjust.

When [ASPECT] is set to [DEFAULT]

- 1) Press ▲ ▼ to select [MODE].
- 2) Press ◀ ▶ to switch [MODE].

INTERNAL	Zoom area is the factory default setting of [SCREEN FORMAT] in [SCREEN SETTING].
FULL	Enlarges the size of the pictures using the whole of the display area selected with [SCREEN FORMAT].

- 3) Press ▲▼ to select [INTERLOCKED].
- 4) Press ◀▶ to switch [INTERLOCKED].

OFF	The [VERTICAL] and [HORIZONTAL] settings are used as the vertical and horizontal zoom ratios respectively.
ON	The zoom ratio is set to the [BOTH] setting. This allows the pictures to be zoomed at equal vertical and horizontal ratios.

Note

- When [ASPECT] is set to [THROUGH], [ZOOM] will not appear.
- When other than [DEFAULT] is selected for [ASPECT], the [MODE] selection setting will not appear.

CLOCK PHASE

Clock phase adjustment achieves the best image when the screen flickers or halos are observed around contours.

- 1) Press ▲▼ to select [CLOCK PHASE].
- 2) Press ◀▶ or <ENTER> button.
 - The [CLOCK PHASE] individual adjustment screen will be displayed.
- 3) Press ◀▶ to adjust the level.
 - The value changes from 0 to 63. Adjust so that the amount of interference is at a minimum.

Note

- The CLOCK PHASE may not be adjusted, depending on the signal.
- No optimal value may be obtained if the output of the PC to which the signal input is applied is unstable.
- No optimal value may be obtained if the total number of dots is not correct.
- The [CLOCK PHASE] can be adjusted only when RGB signal input is applied with RGB1 and RGB2 IN.

GEOMETRY

(PT-DZ110/PT-DS100 only)

Square video can be projected onto a special shaped screen using unique image processing technology.

- 1) Press ▲▼ to select [GEOMETRY].
- 2) Press ◀▶ to switch [GEOMETRY].
 - The setting will change as follows each time ◀▶ is pressed.

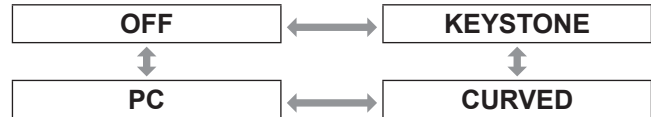

OFF	Geometry correction is not performed.
KEYSTONE	This adjusts projected images when they are distorted to a trapezoid.
CURVED	This adjusts projected images when they are distorted to a curved surface.
PC *	This is for performing geometry correction from a computer.

*: GEOMETRY adjustment should be carried out by a person who is familiar with the projector or by a service person because a high level of skill is required to make successful adjustment.

- 3) Select [KEYSTONE] or [CURVED] in Step 2), and press <ENTER> button.
 - The [GEOMETRY : KEYSTONE] or [GEOMETRY : CURVED] screen will be displayed.
- 4) Press ▲▼ to select the desired adjustment item, and press ◀▶ to adjust the correction amount.
 - You can adjust the projection images as shown below.

POSITION menu

KEYSTONE menu

- VERTICAL KEYSTONE

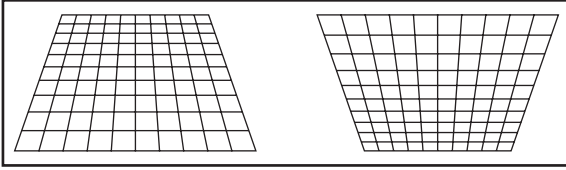

- VERTICAL SUB KEYSTONE

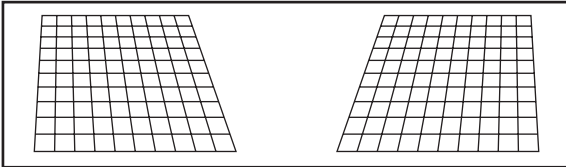

- HORIZONTAL KEYSTONE

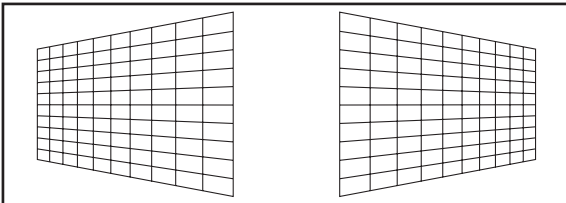

- HORIZONTAL SUB KEYSTONE

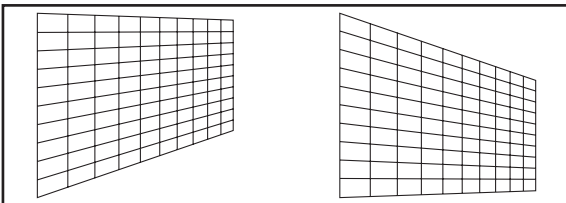

- LINEARITY

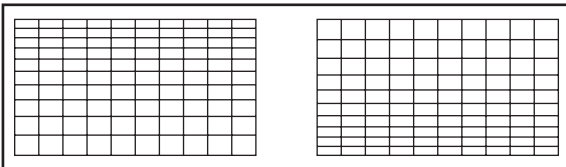

CURVED menu

- LENS THROW RATIO

Set to the throw ratio being used (the projection distance divided by the screen width).

- VERTICAL KEYSTONE

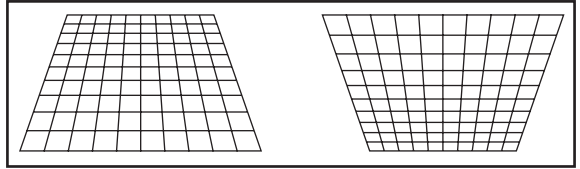

- HORIZONTAL KEYSTONE

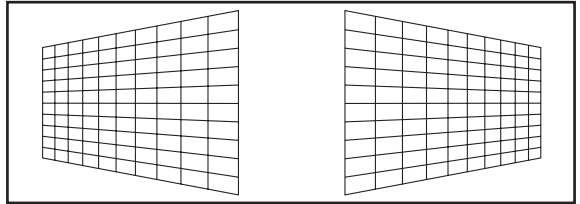

- VERTICAL ARC

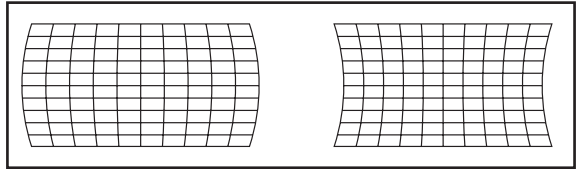

- HORIZONTAL ARC

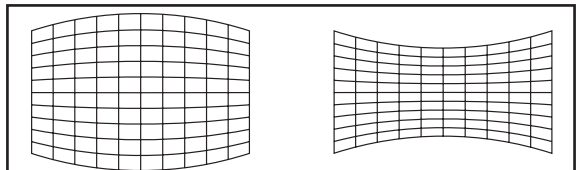

- VERTICAL BALANCE

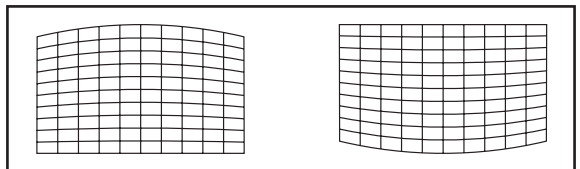

- HORIZONTAL BALANCE

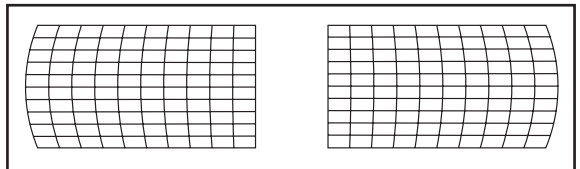

Note

- When [GEOMETRY] setting is set, displayed menu or startup logo might be projected outside of the actual image area.
- If both [EDGE BLENDING] (► page 65) adjustment and [GEOMETRY] correction are used, [EDGE BLENDING] adjustment cannot be made correctly.

KEYSTONE (PT-DW90 only)

If the projector is aligned non-perpendicularly to the screen, or if the projection screen has an angled surface, you can correct keystone.

- 1) Press ▲▼ to select [KEYSTONE].
- 2) Press <ENTER> button.
- 3) Select the desired adjustment item.
- 4) Press ◀▶ to adjust.

■ KEYSTONE

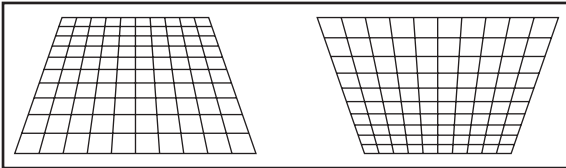

■ SUB KEYSTONE

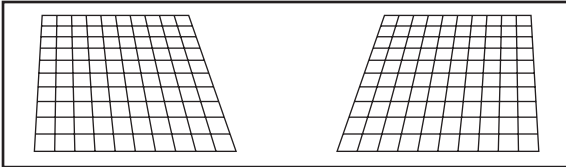

■ LINEARITY

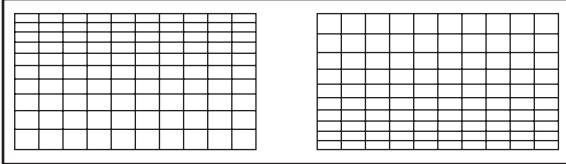

Note

- When [KEYSTONE] setting is set, displayed menu or startup logo might be projected outside of the actual image area.
- You can correct the distortion $\pm 40^\circ$ from the plane. For a better quality image, installing the projector with a minimum of distortion is recommended. (ET-D75LE5: $\pm 22^\circ$, ET-D75LE6: $\pm 28^\circ$)
- Some distortion may be retained for lens shift adjustment.
- The result of the keystone correction will affect the aspect ratio and the size of the image.

ADVANCED MENU

- See “Navigating through the menu” (➔page 50).
- See “MAIN MENU” and “SUB MENU” (➔page 51).

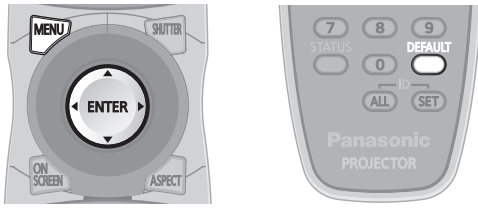

DIGITAL CINEMA REALITY

Increase the vertical resolution when the PAL (or SECAM) 576i signal input or the NTSC 480i, 1 080/50i and 1 080/60i signal input is applied.

- 1) Press ▲▼ to select [DIGITAL CINEMA REALITY].
- 2) Press ◀▶ or <ENTER> button.
 - The [DIGITAL CINEMA REALITY] individual adjustment screen will be displayed.
- 3) Press ◀▶ to select [DIGITAL CINEMA REALITY].
 - The setting will change as follows each time ◀▶ is pressed.

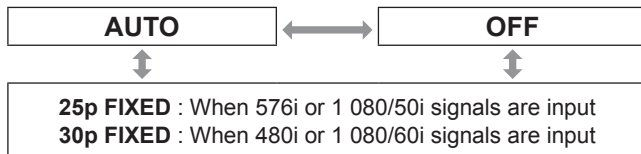

AUTO	Performs automatic detection and cinema processing. (factory default)
OFF	Unforced cinema processing.
25p FIXED	Forced cinema processing (2 : 2 pulldown) is performed when a 576i or 1 080/50i signal is input.
30p FIXED	Forced cinema processing (2 : 2 pulldown) is performed when a 480i or 1 080/60i signal is input.

Note

- In [DIGITAL CINEMA REALITY] mode, the image quality will be deteriorated if [30p FIXED] or [25p FIXED] is selected when the signal is not a 2 : 2 pulldown signal.

BLANKING

Blanking adjustment fine-tunes the images projected by the video deck or other devices when the noise appears on the edges of the screen or if a part of the image lies slightly offscreen.

- 1) Press ▲▼ to select [BLANKING].
- 2) Press <ENTER> button.
 - The [BLANKING] screen will be displayed.
- 3) Press ▲▼ to select the desired item for adjustment.
- 4) Press ◀▶ to adjust blanking.
 - The adjustment value for the PT-DZ110XE can be changed within a range of 0 to 599 vertically and 0 to 959 horizontally.
 - The adjustment value for the PT-DS100XE can be changed within a range of 0 to 524 vertically and 0 to 699 horizontally.
 - The adjustment value for the PT-DW90XE can be changed within a range of 0 to 383 vertically and 0 to 682 horizontally.

When correcting the upper blanking of the screen (top)

Press ◀ to move the blanking zone upward;
Press ▶ to downward.

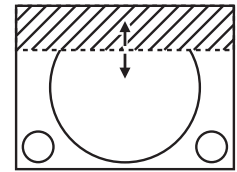

When correcting the lower blanking of the screen (bottom)

Press ▶ to move the blanking zone upward;
Press ◀ to downward.

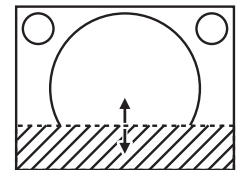

When correcting the left hand blanking of the screen (left)

Press ▶ to move the blanking zone to the right;
Press ◀ to the left.

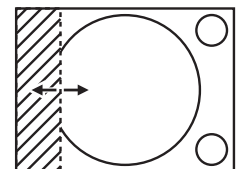

When correcting the right hand blanking of the screen (right)

Press ◀ to move the blanking zone to the right;
Press ▶ to the left.

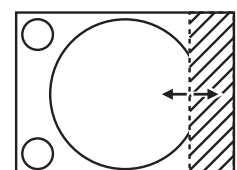

INPUT RESOLUTION

Input resolution adjustment achieves the best image when the screen flickers or halo is observed around the contour. Set the values appropriately for the signal resolution that is being used.

- 1) Press ▲▼ to select [INPUT RESOLUTION].
- 2) Press <ENTER> button.
 - The [INPUT RESOLUTION] screen will be displayed.
- 3) Press ▲▼ to select [TOTAL DOTS], [DISPLAY DOTS], [TOTAL LINES] or [DISPLAY LINES], and the press ◀▶ to adjust it.
 - Each item automatically displays a value in response to the type of the input signal. If vertical stripes appear on the screen or the image is partly missing, increase or decrease the displayed value while observing the screen to achieve the optimal value.

Note

- The vertical stripes will not appear on the all white signal image.
- The picture may be distorted during the adjusting operation, but this is not a fault.
- The [INPUT RESOLUTION] can be adjusted only when RGB signal input is applied with RGB1 and RGB2 IN.

CLAMP POSITION

Use the clamp position adjustment to achieve the optimal value when dark areas of the image are crushed or displayed in green.

- 1) Press ▲▼ to select [CLAMP POSITION].
- 2) Press ◀▶ to adjust.
 - The value changes from 1 to 255.
 - **The optimal value for the clamp position adjustment**
 If dark areas are crushed :
 The optimal value is the point where the dark area is best improved.
 If the dark areas are displayed in green :
 The optimal value is the point where the green areas become black and the crushing effect is rectified.

Note

- The [CLAMP POSITION] can be adjusted only when the RGB signal input is applied with RGB1 and RGB2 IN.
- The [CLAMP POSITION] may not be adjusted, depending on the signal.

EDGE BLENDING

The built-in edge blending feature allows multiple projector images to be seamlessly overlapped.

- 1) Press ▲▼ to select [EDGE BLENDING].
- 2) Press ◀▶ to switch [EDGE BLENDING].
 - The setting will change as follows each time ◀▶ is pressed.



OFF	When the multi-screens are not going to be used.
ON	When the default linear blending ramps are sufficient.
USER	When a user-defined blending ramp is required. These ramps can be defined and uploaded to the projector through the RS-232 port. Consult your dealer for details.

- 3) Press <ENTER> button.
 - The [EDGE BLENDING] screen will be displayed.
- 4) Press ▲▼ to specify the area to be adjusted.
 - To blend the top edge: set [UPPER] to [ON].
 - To blend the bottom edge: set [LOWER] to [ON].
 - To blend the left edge: set [LEFT] to [ON].
 - To blend the right edge: set [RIGHT] to [ON].
- 5) Press ◀▶ to toggle [ON] and [OFF].
- 6) Press ◀▶ to adjust the overlap width and the starting point.

ADVANCED MENU

■ To display the adjustment marker

7) Press ▲▼ to select [MARKER].

8) Press ◀▶ to select [ON].

- A marker for adjusting the overlap position appears. The optimal point is the position where the red line of one frame overlaps the green line of the other frame.

The blending widths of each projector must be set to the same value. Optimal blending cannot be achieved if the widths are different.

The optimal point is where these lines overlap.

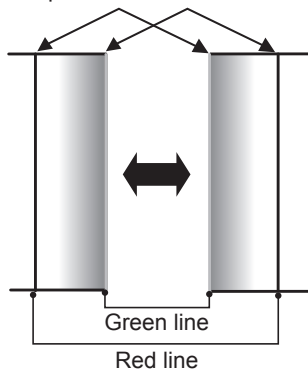

9) Press ▲▼ to select [BRIGHT ADJUST].

10) Press <ENTER> button.

- The [BRIGHT ADJUST] screen will be displayed.

11) Press ▲▼ to select [BRIGHT INSIDE].

12) Press <ENTER> button.

- The [BRIGHT INSIDE] individual adjustment screen will be displayed.
- When [INTERLOCKED] is set to [OFF], individual adjustment of [RED], [GREEN] and [BLUE] will be possible.

13) Press ▲▼ to select an item, and press ◀▶ to adjust the setting.

- Once adjustment is complete, press <MENU> button to return to [BRIGHT ADJUST] screen.

14) Press ▲▼ to select the part of [UPPER], [LOWER], [RIGHT], [LEFT].

15) Press ◀▶ to adjust the width for correcting the [BRIGHT INSIDE] setting (0 to 255).

16) Press ▲▼ to select [BRIGHT OUTSIDE].

17) Press <ENTER> button.

- The [BRIGHT OUTSIDE] individual adjustment screen will be displayed.
- When [INTERLOCKED] is set to [OFF], individual adjustment of [RED], [GREEN] and [BLUE] will be possible.

18) Press ▲▼ to select an item, and press ◀▶ to adjust the setting.

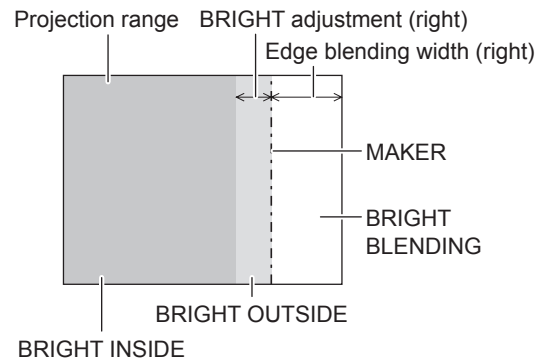

Note

- The [BRIGHT INSIDE] adjustments are used to match the projector's main-screen-area black levels to the level within the blended area. The [BRIGHT OUTSIDE] adjustments may be used to fine adjust the thin borders on either side of the blend area, but are often not needed.
- When a rear screen or screen with a high gain is used, the blended areas may appear to be discontinuous depending on the viewing position.
- When using both horizontal and vertical edge blending functions to form a multiple projector image, adjust the [BRIGHT BLENDING] before performing the adjustment in Step 11).
- When using only one of the horizontal or vertical edge blending functions, set all items of [BRIGHT BLENDING] to [0].

FRAME DELAY

When 1 080/60i, 1 080/50i and 1 080/24sF signals are being input, this simplifies image processing so that the video frame delay is shortened.

- 1) Press **▲▼** to select **[FRAME DELAY]**.
- 2) Press **◀▶** to switch **[FRAME DELAY]**.
 - The setting will change as follows each time **◀▶** is pressed.



DEFAULT	This is the standard setting.
SHORT	Shortens the delay at the expense of some picture quality.

Note

- When **[FRAME DELAY]** is set to **[SHORT]**, deterioration in the picture quality will occur. Furthermore, the noise reduction function cannot be used.

RASTER POSITION

When the scaler is set such that the image is smaller than the display area, the image can be moved to any position inside the display area.

- 1) Press **▲▼** to select **[RASTER POSITION]**.
- 2) Press **<ENTER>** button.
 - The **[RASTER POSITION]** screen will be displayed.
- 3) Press **▲▼◀▶** to adjust the position.

DISPLAY LANGUAGE menu

- See “Navigating through the menu” (➡page 50).
- See “MAIN MENU” and “SUB MENU” (➡page 51).

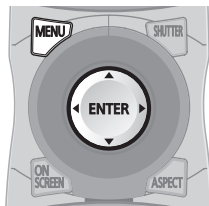

Changing the display language

This lets you switch the on-screen display language.

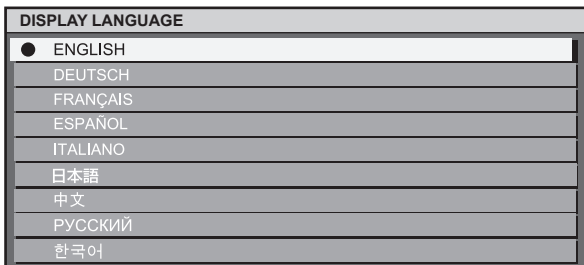

- Menus, setting items, adjustment screens, and control button names will be displayed in the language the user chooses.
- The available languages are: English, German (DEUTSCH), French (FRANÇAIS), Spanish (ESPAÑOL), Italian (ITALIANO), Japanese (日本語), Chinese (中文), Russian (русский), and Korean (한국어).

Note

- The on-screen display of the projector is set to the English language on shipping.

DISPLAY OPTION menu

- See “Navigating through the menu” (➔page 50).
- See “MAIN MENU” and “SUB MENU” (➔page 51).

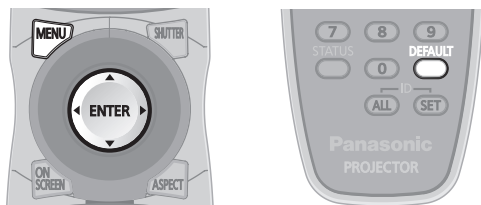

COLOR MATCHING

When multiple sets are used simultaneously, this projector allows the user to correct the difference of colors among the sets.

1) Press ▲▼ to select [COLOR MATCHING].

2) Press ◀▶ to switch [COLOR MATCHING].

- The setting will change as follows each time ◀▶ is pressed.



OFF	Color matching adjustment is not carried out.
3COLORS	It is possible to adjust the 3colors of [RED], [GREEN] and [BLUE].
7COLORS	It is possible to adjust the 7colors of [RED], [GREEN], [BLUE], [CYAN], [MAGENTA], [YELLOW] and [WHITE].
709MODE	Refer to “■ Adjusting the color matching using a colorimeter” (➔ on this page) for details on this mode.
MEASURED	Refer to “■ Adjusting the color matching using a colorimeter” (➔ on this page) for details on this mode.

■ If [3COLORS] or [7COLORS] was selected in step 2).

3) Press <ENTER> button.

- The [3COLORS] or [7COLORS] screen will be displayed.

4) Press ▲▼ to select [RED], [GREEN] and [BLUE] (if [7COLORS] was selected, select [RED], [GREEN], [BLUE], [CYAN], [MAGENTA], [YELLOW], and [WHITE]).

5) Press <ENTER> button.

- The [3COLORS:RED], [3COLORS:GREEN] or [3COLORS:BLUE] screen will be displayed. If you selected [7COLORS], the [7COLORS:RED], [7COLORS:GREEN], [7COLORS:BLUE], [7COLORS:CYAN], [7COLORS:MAGENTA], [7COLORS:YELLOW], or [7COLORS:WHITE] screen will be displayed.
- If [AUTO TEST PATTERN] is turned [ON], the test pattern of the selected color is displayed.

6) Press ◀▶ to adjust the values.

- These values can be adjusted from 0 (off) to 2 048 (full gain).

Note

- The effects of correcting the adjustment color:
When tuning the correction color that is the same as the adjustment color: the brightness of the adjustment color changes.
RED : RED is added to or reduced from the adjustment color.
GREEN : GREEN is added to or reduced from the adjustment color.
BLUE : BLUE is added to or reduced from the adjustment color.
- This adjustment should be carried out by a person who is familiar with the projector or by a service person because a high level of skill is required to make successful adjustment.
- Pressing <DEFAULT> button will restore the factory defaults for all items.
- When any setting other than [OFF] has been selected for [COLOR MATCHING], the [COLOR TEMPERATURE] setting is fixed at [USER1].

■ Adjusting the color matching using a colorimeter

The [RED], [GREEN], [BLUE], [CYAN], [MAGENTA], [YELLOW] and [WHITE] colors can be changed to the desired hues using a colorimeter which is capable of measuring the chromaticity coordinates and luminance.

● Inputting the current luminance and chromaticity coordinates

1) Press ▲▼ to select [COLOR MATCHING].

2) Press ◀▶ to select [709MODE] or [MEASURED].

DISPLAY OPTION menu

- 3) Press **<ENTER>** button.
 - The [709MODE] or [MEASURED MODE] screen will be displayed.
 - 4) Press **▲ ▼** to select [MEASURED DATA].
 - 5) Press **<ENTER>** button.
 - The [MEASURED DATA] screen will be displayed.
 - 6) Use the colorimeter to measure the luminance (Y) and chromaticity coordinates (x, y)
 - 7) Press **▲ ▼** to select the colors, and press **◀ ▶** to select their values.
 - If [AUTO TEST PATTERN] is turned [ON], the test pattern of the selected color is displayed.
 - 8) After all the data has been input, press **<MENU>** button.
 - The [709MODE] or [MEASURED MODE] screen will be displayed.
- Inputting the coordinates of a desired color (only [MEASURED])
- 9) Press **▲ ▼** to select [TARGET DATA].
 - 10) Press **<ENTER>** button.
 - The [TARGET DATA] screen will be displayed.
 - 11) Press **▲ ▼** to select the desired colors, and press **◀ ▶** to input their coordinates.
 - If [AUTO TEST PATTERN] is turned [ON], the test pattern of the selected color is displayed.
 - 12) After all the data has been input, press **<MENU>** button.

Note

- If [709MODE] has been selected as the [COLOR MATCHING] setting, the 3 primary colors defined by the ITU-R BT.709 standard will be set as the target data.
- If the target data is outside the color range of the projector, the colors will not be projected correctly.

LARGE SCREEN CORRECTION

When viewing images close up on a large screen, you can correct the colors that appear lighter on the screen so that they appear the same as the colors that would appear on a normal-sized screen.

- 1) Press **▲ ▼** to select [LARGE SCREEN CORRECTION].
- 2) Press **◀ ▶** to switch [LARGE SCREEN CORRECTION].
 - The setting will change as follows each time **◀ ▶** is pressed.

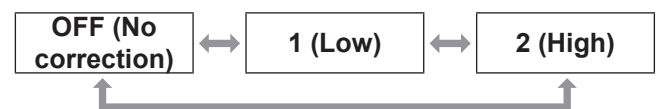

SCREEN SETTING

(PT-DZ110/PT-DS100 only)

Set this in accordance with the screen you are using. When the projection image aspect ratio is changed, the projector makes corrections to ensure the optimal images for the set screen size.

- 1) Press **▲ ▼** to select [SCREEN SETTING].
- 2) Press **<ENTER>** button.
 - The [SCREEN SETTING] screen will be displayed.
- 3) Press **◀ ▶** to switch [SCREEN FORMAT].

■ PT-DZ110XE

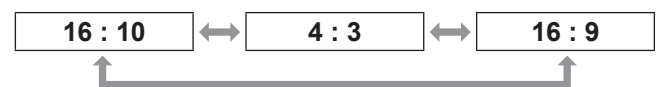

■ PT-DS100XE



4) Press ◀▶ to adjust [SCREEN POSITION].

- In the case of the PT-DZ110XE :
When [SCREEN FORMAT] is [16 : 9]
Adjustment range: -60 to +60
When [SCREEN FORMAT] is [4 : 3]
Adjustment range: -160 to +160
- In the case of the PT-DS100XE, you can adjust the setting from -132 to +131.

Note

- [SCREEN POSITION] cannot be adjusted when [SCREEN FORMAT] is [16 : 10] (PT-DZ110XE) or [4 : 3] (PT-DS100XE).

WAVEFORM MONITOR

(PT-DZ110 only)

This function displays the waveform of the input signal from a connected peripheral device. You can check if the image output (BRIGHTNESS) signal level is within the range recommended by this projector and adjust it as necessary.

1) Press ▲▼ to select [WAVEFORM MONITOR].

2) Press ◀▶ to switch [WAVEFORM MONITOR].

- The setting will change as follows each time ◀▶ is pressed.



3) Press the <MENU> button twice to turn off the menu screen.

4) Select any horizontal line with the ▲▼.

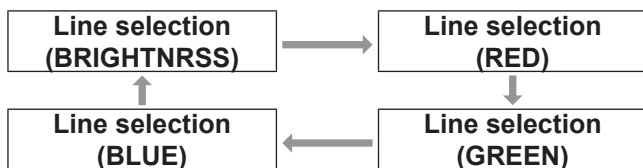

Note

- Setting can also be performed using the <FUNCTION> button. (➔page 85)

Adjust the waveform

Project the brightness adjustment signal from, for example, a commercially available adjustment disc (0% [0 IRE or 7.5 IRE] - 100% [100 IRE]) and adjust the waveform.

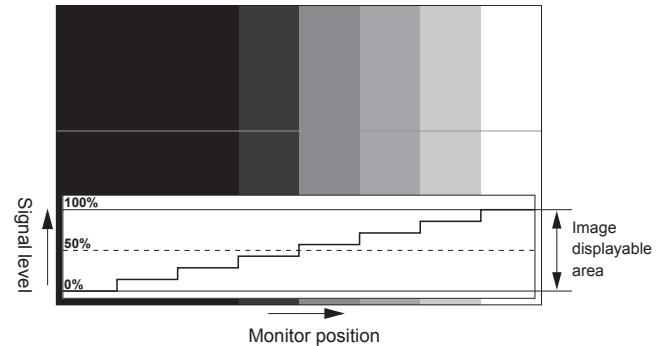

Adjusting brightness

1) Select [Line selection (BRIGHTNRSS)] in the waveform monitor.

2) Adjust the black level.

- In [BRIGHTNESS] of on-screen menu [PICTURE], adjust the 0% of the black level of the image signal to the position corresponding to 0% on the waveform monitor.

3) Adjust the white level.

- In [CONTRAST] of on-screen menu [PICTURE], adjust the 100% of the while level of the image signal to the position corresponding to 100% on the waveform monitor.

Adjusting RED, GREEN, and BLUE

1) Set [COLOR TEMPERATURE] to [USER1] or [USER2]. (➔page 55)

2) Select [Line selection (RED)] in the waveform monitor.

3) Adjust the dark portion of RED.

- In [RED] of [WHITE BALANCE LOW], adjust the 0% of the black level of the image signal to the position corresponding to 0% on the waveform monitor. (➔page 55)

DISPLAY OPTION menu

4) Adjust the light portion of RED.

- In [RED] of [WHITE BALANCE HIGH], adjust the 100 % of the white level of the image signal to the position corresponding to 100 % on the waveform monitor. (➡page 55)

5) Adjust [GREEN] and [BLUE] in a similar manner.

Note

- When the DVI-D signal, HDMI signal, or SDI signal is inputted, check that the [DVI SIGNAL LEVEL], [HDMI SIGNAL LEVEL], and [SDI SIGNAL LEVEL] are correctly set before adjusting the black level.
- The keystone cannot be applied to the waveform monitor display.
- The waveform monitor cannot be displayed in the [P IN P] mode.
- If the [P IN P] mode is set while the waveform is being monitored, the waveform monitor will turn off.
- The waveform monitor is not displayed while the on-screen display is off.

AUTO SIGNAL

You can turn ON/OFF automatically detecting system of the AUTO SETUP feature.

1) Press ▲ ▼ to select [AUTO SIGNAL].

2) Press ◀ ▶ to switch [AUTO SIGNAL].

- The setting will change as follows each time ◀ ▶ is pressed.



OFF	Only when <AUTO SETUP> button is pressed, the projected image position will be adjusted.
ON	If unregistered signals are input when [ON] is selected, auto setup will be initiated automatically.

AUTO SETUP

Use this setting when adjusting a specific or oblong (16:9, etc.) signal.

1) Press ▲ ▼ to select [AUTO SETUP].

2) Press <ENTER> button.

- The [AUTO SETUP] screen will be displayed.

3) Press ▲ ▼ to select [MODE].

4) Press ◀ ▶ to switch [MODE].

- The setting will change as follows each time ◀ ▶ is pressed.



DEFAULT	To receive signals of which image aspect is 4:3 or 5:4 (applicable resolution : 640 × 400, 640 × 480, 800 × 600, 832 × 624, 960 × 720, 1 024 × 768, 1 152 × 864, 1 152 × 870, 1 280 × 960, 1 280 × 1 024, 1 600 × 1 200, 1 400 × 1 050)
WIDE	To receive signals of which the image aspect is wide (applicable resolution: 720 × 400, 848 × 480, 1 280 × 720, 1 024 × 600, 1 120 × 750, 1 440 × 900, 1 680 × 1 050)
USER	To receive signals of specific horizontal resolution (number of horizontally displayed dots)

5) If [USER] is selected, press ◀ ▶ to enter the horizontal resolution of signal source into [DISPLAY DOTS].

6) Press <ENTER> button.

- Execute automatic adjustment. A message "PROGRESS..." appears during automatic adjustment. When the adjustment is complete, the system returns to the input screen.

Adjusting the position automatically

1. Select [POSITION ADJUST] in step 3).
2. Press ◀▶ to switch [POSITION ADJUST].
 - The setting will change as follows each time ◀▶ is pressed.

OFF	↔	ON
OFF		Automatic adjustment is off.
ON		Screen position and size are adjusted during AUTO SETUP operation.

Adjusting the signal level automatically

1. Select [SIGNAL LEVEL ADJUST] in step 3).
2. Press ◀▶ to switch [SIGNAL LEVEL ADJUST].
 - The setting will change as follows each time ◀▶ is pressed.

OFF	↔	ON
OFF		Automatic adjustment is off.
ON		The black level (On-screen menu [BRIGHTNESS]) and white level (On-screen menu [CONTRAST]) are adjusted during AUTO SETUP operation.

Note

- If the input image is not a still image with a clear difference between black and white, the [SIGNAL LEVEL ADJUST] function may not operate normally.

RGB IN (Only RGB input)

Change this setting to change the input impedance of the synchronous signal input.

- 1) Press ▲▼ to select [RGB IN].
- 2) Press <ENTER> button.
 - The [RGB IN] screen will be displayed.
- 3) Press ▲▼ to select [RGB1 SYNC TERMINAL] or [RGB2 SYNC TERMINAL].
- 4) Press ◀▶ to switch.
 - The setting will change as follows each time ◀▶ is pressed.

LOW	↔	HIGH
LOW		Input impedance is set to [LOW].
HIGH		Input impedance is set to [HIGH].

DVI-D IN

Change this setting if video does not display normally when the projector and an external device are connected via DVI.

- 1) Press ▲▼ to select [DVI-D IN].
- 2) Press <ENTER> button.
 - The [DVI-D IN] screen will be displayed.
- 3) Press ▲▼ to select [DVI EDID].
- 4) Press ◀▶ to switch [DVI EDID].
 - The setting will change as follows each time ◀▶ is pressed.



EDID3	Switch between fine settings for a moving image and for a still image.
EDID1	Mainly select this when an external device (DVD player, etc.) for outputting video signals of a moving image system is connected to DVI-D IN.
EDID2 : PC	Mainly use this when an external device (PC, etc.) for outputting video signals of a still image system is connected to DVI-D IN.

- 5) Press ▲▼ to select [DVI SIGNAL LEVEL].

DISPLAY OPTION menu

6) Press ◀▶ to switch [DVI SIGNAL LEVEL].

- The setting will change as follows each time ◀▶ is pressed.

0-255 : PC	↔	16-235
0-255 : PC		Select this when, for example, an external device (PC, etc.) is connected via the DVI terminal output.
16-235		Select this when, for example, an external device (DVD player, etc.) is connected via the HDMI terminal output using a conversion cable.

Note

- The optimal setting differs depending on the output setting of the connected external device. Refer to the instruction manual of the external device.
- If the setting is changed, the data for plug and play changes. For the plug and play compatible resolutions, refer to "List of compatible signals" (▶ page 123).

HDMI IN

Change this setting if video does not display normally when the projector and an external device are connected via HDMI.

- Press ▲▼ to select [HDMI IN].
- Press <ENTER> button.
 - The [HDMI IN] screen will be displayed.
- Press ◀▶ to switch [HDMI SIGNAL LEVEL].
 - The setting will change as follows each time ◀▶ is pressed.

0-1023	↔	64-940
0-1023		Select this when, for example, a DVI terminal output of an external device (PC etc.) is connected to HDMI IN using a conversion cable, etc.
64-940		Select this when, for example, an HDMI terminal output of an external device (DVD player, etc.) is connected to HDMI IN.

Note

- The optimal setting differs depending on the output setting of the connected external device. Refer to the instruction manual for the external device.
- The displayed HDMI signal level is the value when the input is 30 bit.

SDI IN (PT-DZ110/PT-DS100 only)

You can select signal amplitude type.
Available with YP_BPr or RGB of HD-SDI signal.

- Press ▲▼ to select [SDI IN].
- Press <ENTER> button.
 - The [SDI IN] screen will be displayed.
- Press ◀▶ to switch [SDI SIGNAL LEVEL].
 - The setting will change as follows each time ◀▶ is pressed.

64-940	↔	4-1019
64-940		Normal setting
4-1019		For when grey color is too close to black

ON-SCREEN DISPLAY

The user can specify the on-screen display.

- Press ▲▼ to select [ON-SCREEN DISPLAY].
- Press <ENTER> button.
 - The [ON-SCREEN DISPLAY] screen will be displayed.
- Press ▲▼ to select the desired item, and press ◀▶ to change the setting.

OSD POSITION

This sets the position of the on-screen display (OSD).

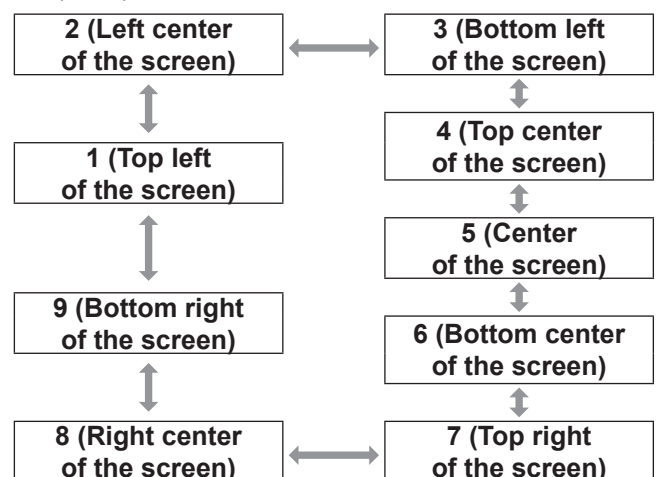

OSD DESIGN

This sets the color of the on-screen display (OSD).

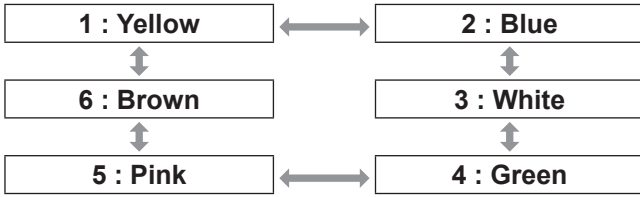

OSD MEMORY

The current menu cursor position will be retained temporarily unless the projector switched off.



INPUT GUIDE

This sets whether to display the currently selected input guide at the position set for [OSD POSITION].



WARNING MESSAGE

This sets the display of warning messages.



BACK COLOR

This sets the color for the projection screen when no signals are being input.

- 1) Press ▲▼ to select [BACK COLOR].
- 2) Press ◀▶ to switch [BACK COLOR].
 - The setting will change as follows each time ◀▶ is pressed.

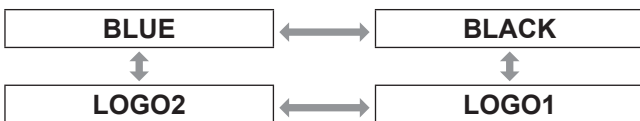

BLUE	The entire projection area will appear blue.
BLACK	The entire projection area will appear black.
LOGO1	The picture registered by the user will be projected in the projection area.
LOGO2	The Panasonic logo is projected.

Note

- Separate software is required in order to create the pictures to use for [LOGO1]. Consult your dealer.

STARTUP LOGO

This sets the startup logo that is projected when the power is turned on.

- 1) Press ▲▼ to select [STARTUP LOGO].
- 2) Press ◀▶ to switch [STARTUP LOGO].
 - The setting will change as follows each time ◀▶ is pressed.



LOGO2	The Panasonic logo is projected.
NONE	No startup logo is projected.
LOGO1	The picture registered by the user will be projected.

Note

- Separate software is required in order to create the pictures to use for [LOGO1]. Consult your dealer.
- STARTUP LOGO will be displayed for 15 seconds.

FREEZE

You can freeze the projected image and stop the sound temporarily, regardless of the playing condition of the connected device.

- 1) Press ▲▼ to select [FREEZE].
- 2) Press <ENTER> button.
 - Press <MENU> button to escape.

PROJECTOR SETUP menu

- See “Navigating through the menu” (➔page 50).
- See “MAIN MENU” and “SUB MENU” (➔page 51).

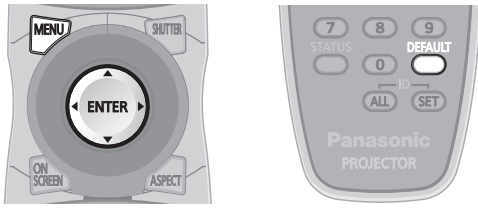

PROJECTOR ID

The projector has an ID number setting function that helps the user to control two or more projectors either simultaneously or separately with a single remote control.

- 1) Press ▲▼ to select [PROJECTOR ID].
- 2) Press ◀▶ to switch [PROJECTOR ID].
 - The setting will change as follows each time ◀▶ is pressed.

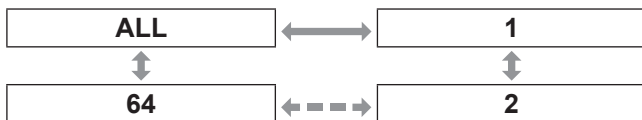

Note

- The ID number can be set to [ALL], or selected from [1] to [64].
- If the projectors are given ID numbers, their remote controls must be assigned the same ID numbers, respectively.
- If the ID number of a projector is set to [ALL], it can be controlled by the remote control or the PC with any ID number. If multiple projectors are used and some of them have their IDs set to “ALL”, they cannot be controlled separately from the projectors with other ID numbers. For details on remote control ID setting, refer to “Setting projector ID number to remote control” (➔page 21).

INSTALLATION

A projection scheme can be chosen depending on the installation of the projector. If the picture is shown upside down or in reverse, change the projection scheme.

- Select the setting by displaying the on-screen indications using buttons of the remote control or the control panel on the main unit.

- 1) Press ▲▼ to select [INSTALLATION].
- 2) Press ◀▶ to switch [INSTALLATION].
 - The setting will change as follows each time ◀▶ is pressed.

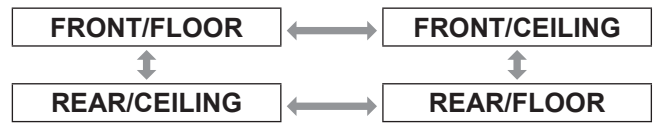

FRONT/FLOOR	Setting on a desk/floor and projecting from front
FRONT/CEILING	Mounting on the ceiling and projecting from front
REAR/FLOOR	Setting on a desk/floor and projecting from rear
REAR/CEILING	Mounting on the ceiling and projecting from rear

HIGH ALTITUDE MODE

If you use the projector at high elevation (1 400 m to 2 700 m), the [HIGH ALTITUDE MODE] setting needs to be [ON] to set the fan speed high.

- 1) Press ▲▼ to select [HIGH ALTITUDE MODE].
- 2) Press ◀▶ to switch [HIGH ALTITUDE MODE] and press <ENTER> to select.
 - The setting will change as follows each time ◀▶ is pressed.



OFF	Select this when using in normal environment (less than 1 400 m above sea level)
ON	Select this when using at high altitude (above 1 400 m and less than 2 700 m above sea level)

- 3) When the confirmation message is displayed, select [OK] or [CANCEL].

Note

- The loudness of fan noise depends on the [HIGH ALTITUDE MODE] setting.
- The separately-sold Smoke Cut Filter cannot be used when the [HIGH ALTITUDE MODE] is [ON].

COOLING CONDITION

You can control the fan speed for projecting angle. When the projector is angled, [COOLING CONDITION] setting must be set correctly. Failure to observe this may result in malfunctions, or the life of the lamp or the other components may be shortened.

- 1) Press ▲▼ to select [COOLING CONDITION].
- 2) Press <ENTER> button.
 - The [COOLING CONDITION] screen will be displayed.
- 3) Press ▲▼ to select cooling condition.
- 4) Press <ENTER> button.
- 5) When the confirmation message is displayed, select [OK] or [CANCEL].

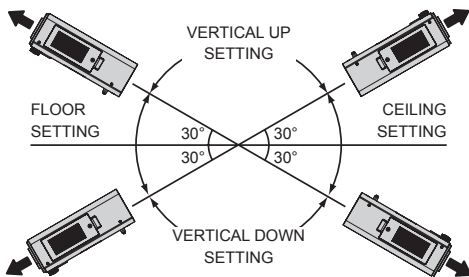

LAMP SELECT

You can select a lamp lighting pattern for using environment.

- 1) Press ▲▼ to select [LAMP SELECT].
- 2) Press ◀▶ to switch [LAMP SELECT].
 - The setting will change as follows each time ◀▶ is pressed.

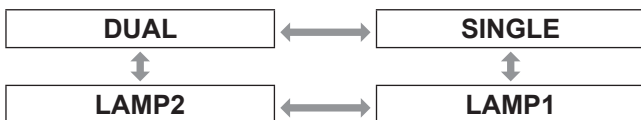

DUAL	All lamps will light.
SINGLE	Selects a lamp with shorter duration of use.
LAMP1	Selects the Lamp unit 1.
LAMP2	Selects the Lamp unit 2.

- 3) Press <ENTER> button.

Note

- If, in the [SINGLE], [LAMP1] or [LAMP2] mode, one lamp remains off or the currently active lamp exceeds 3 000 hours of cumulative operating time (when [HIGH] is selected as the [LAMP POWER] setting), the other lamp will light.
If, in the [DUAL] mode, one lamp remains off or the currently active lamp exceeds 3 000 hours of cumulative operating time (when [HIGH] is selected as the [LAMP POWER] setting), the other lamp alone will light. However, if both lamps remain off or the 3 000 hours of cumulative operating time (when [HIGH] is selected as the [LAMP POWER] setting) are exceeded, the projector will enter the standby mode.
- The colors of the items indicate the status.
Green→Current setting
Yellow→Current setting (when a lamp fails or fails to light)
Red→Lamp that has failed to light
White→Any other status
- If the projector is repeatedly used for short periods of time, the lamps will need to be replaced more frequently.

LAMP RELAY

If using the projector for a continuous period of 24 hours or more, this setting can be used to automatically switch the lamps that are turned on in order to reduce the lamp deterioration that can occur as a result of continuous use.

- 1) Press ▲▼ to select [LAMP RELAY].
- 2) Press <ENTER> button.
 - The [LAMP RELAY] screen is displayed and the adjustment mode (flashing) is activated.
- 3) Press ◀▶ to select [HOUR] or [MINUTE] and use ▲▼ to adjust the time.
- 4) Press <ENTER> button.
 - The lamp relay is set to the selected time.

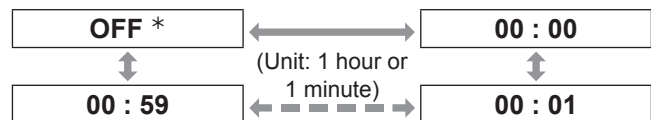

*: When setting the [MINUTE], irrespective of the set value for [HOUR], please adjust and set in the following order of 59 minutes, [OFF], 00 minutes.

PROJECTOR SETUP menu

Note

- Only when [DUAL] or [SINGLE] is selected in [LAMP SELECT], [LAMP RELAY] is available
- If [DUAL] is selected in [LAMP SELECT], only one lamp is turned on for four hours after the set time.
- The setting time will be the local time. (→ page 85)
- The time can be input directly using the numeral keys on the remote control.
- If the filter is running low, only one lamp will light even when [DUAL] is selected. The lamps will light as normal once the filter has been replaced and the residual filter has been reset.

LAMP POWER

The luminance of the projection lamp can be changed depending on user's needs or the viewing conditions.

1) Press ▲ ▼ to select [LAMP POWER].

2) Press ◀ ▶ to switch [LAMP POWER].

- The setting will change as follows each time ◀ ▶ is pressed.



HIGH	Set when high brightness is necessary.
LOW	Set when high brightness is not necessary.

Note

- When set to [LOW], it is possible to reduce power consumption, reduce operating noise and extend lamp service life.

BRIGHTNESS CONTROL

This projector has a built-in brightness sensor for measuring the lamp power and a function for correcting the screen brightness according to the change in lamp power.

With this function, you can reduce changes in brightness caused by aging of the lamps when multiple screens are projected using multiple projectors, or minimize any fluctuations in brightness.

■ BRIGHTNESS CONTROL GAIN

This function is used to adjust the brightness when multiple screens are projected using multiple projectors.

1) Press ▲ ▼ to select [BRIGHTNESS CONTROL GAIN].

2) Press ◀ ▶ to adjust.

Operation	Adjustment		Adjustment range
	Brightness	Max. quantity of brightness control	
Press ▶.	Increases	Decreases	Maximum value 100 %
Press ◀.	Decreases	Increases	Minimum value 20 %

Note

- When using one projector, the maximum quantity of brightness control is obtained by subtracting the value of [BRIGHTNESS CONTROL GAIN] from 100 %. If the [BRIGHTNESS CONTROL GAIN] is set to 100 %, the maximum quantity of control is 0 % and the brightness cannot be corrected using the brightness control function.
- The brightness will not stabilize for 8 minutes after the lamp is turned on. Make adjustments after at least eight minutes has elapsed after the power is turned on.
- The adjustment in [BRIGHTNESS CONTROL GAIN] will be reflected in all of the image signals, internal test pattern, and on-screen menu.
- [BRIGHTNESS CONTROL GAIN] remains effective even if [BRIGHTNESS CONTROL SETUP] is [OFF].

■ BRIGHTNESS CONTROL SETUP

This function is used to set the operation of the brightness control.

1) Press ▲ ▼ to select [BRIGHTNESS CONTROL SETUP].

2) Press <ENTER> button.

- The [BRIGHTNESS CONTROL SETUP] screen will be displayed.

3) Press ▲ ▼ to select [MODE].

4) Press ◀ ▶ to switch [MODE].

- The setting will change as follows each time ◀ ▶ is pressed.



OFF	Brightness correction with the brightness sensor is not performed.
AUTO	Brightness is corrected with the brightness sensor. If lamp power changes, screen brightness will correct automatically.
PC	Nine or more projectors are operated simultaneously using a computer and the [Multi Projector Monitoring & Control Software].

● When [MODE] is set to [AUTO]

5) Press ▲▼ to select [LINK].

6) Press ◀▶ to switch [LINK].

- The setting will change as follows each time ◀▶ is pressed.



OFF	<p>Brightness is corrected using the brightness sensor of one of the projectors, without linking with other projectors.</p> <p>A smaller [BRIGHTNESS CONTROL GAIN] value means the constant brightness can be maintained for longer.</p>
GROUP A - D	<p>Brightness is corrected using brightness sensors of multiple projectors linked with each other.</p> <p>Up to 4 groups from A to D can be set within the same sub-network using the network function that links multiple projectors.</p> <p>Up to 8 projectors can be registered in 1 group and linked with each other.</p>

7) Press ▲▼ to select [APPLY].

8) Press <ENTER> button.

- The selected [MODE] and [LINK] are activated, then the [BRIGHTNESS CONTROL STATUS] screen will be displayed.
- If <ENTER> button is pressed while [MODE] of the brightness control is not switched to [OFF], the lamp power at the time is saved as the reference power.
- If <ENTER> button is pressed while [LINK] is [GROUP A - D], the group name is displayed on the screens of the projectors that are set in the same group.

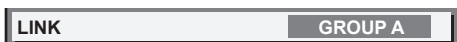

Note

- When setting [MODE] of the brightness control to [AUTO] or [PC], execute brightness control with the shutter open for at least 2 minutes.
- If the shutter is closed within about 10 minutes after the lamp is turned on while the brightness control is set to [MODE], [AUTO], or [PC], the brightness cannot be measured. In this case, the brightness may be corrected about 2 minutes after the shutter is opened.
- While [MODE] of the brightness control is set to [AUTO] or [PC], the [DYNAMIC IRIS] function is kept [OFF (No correction)].
- While [MODE] of the brightness control is set to [AUTO] or [PC], the [LAMP POWER] is fixed to [HIGH] or [LOW]. When changing the lamp power, return [MODE] of the brightness control to [OFF], then change the lamp power and adjust the brightness control again.
- While [MODE] of the brightness control is set to [AUTO] or [PC], the lamp power is measured automatically about 8 minutes after the lamp is turned on and then corrected so that the screen brightness will be the same as the reference brightness when the brightness control is executed. The lamp power is not measured for about 8 minutes after the lamp is turned on as it does not stabilize within this period.
- While [MODE] of the brightness control is set to [AUTO], if the lamp is kept on for more than 25 hours, the brightness is corrected automatically every 25 hours.
- While [LAMP SELECT] is set to [DUAL] and [MODE] is set to [AUTO], if the lamp goes off, the brightness is corrected as much as possible about 1 minute after.
- While [MODE] of the brightness control is set to [AUTO] and [LINK] is set to [OFF], the brightness is corrected until the maximum quantity of correction is achieved.
- The brightness may be dispersed largely because of dust sticking to the lens, screen, or inside of the projector, depending on the environment in which the projector has been installed.
- If the brightness fluctuates significantly because of aging of the lamp or if the lamp has been replaced, re-adjust the brightness control.

BRIGHTNESS CONTROL STATUS

This function displays the status of the brightness control.

1) Press ▲▼ to select [BRIGHTNESS CONTROL STATUS].

2) Press <ENTER> button.

- The [BRIGHTNESS CONTROL STATUS] screen will be displayed.

PROJECTOR SETUP menu

●When [MODE] of brightness control is [OFF]

The state that the brightness control is OFF is displayed.

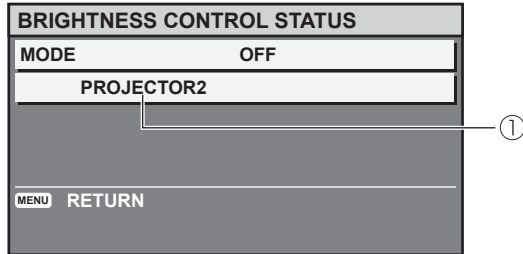

① The name of this projector is displayed.

●When [MODE] of brightness control is [AUTO] and [LINK] is [OFF]

The state that the LINK is OFF is displayed.

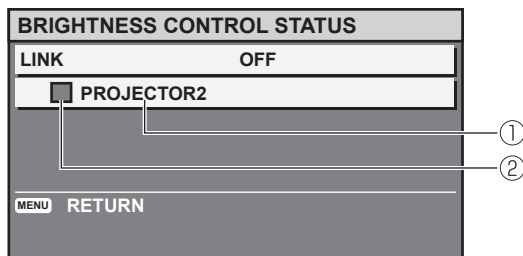

① The name of this projector is displayed.

② The state is indicated by color.

GREEN : The brightness can be corrected by a significant margin.

YELLOW : The brightness can no longer be corrected by a significant margin.

RED : There is an error in brightness control.

●When [MODE] of brightness control is set to [AUTO] and [LINK] is set to [GROUP A - D]

The brightness control of up to 8 projectors linked with each other, including the projector operated using the on-screen menu, is displayed.

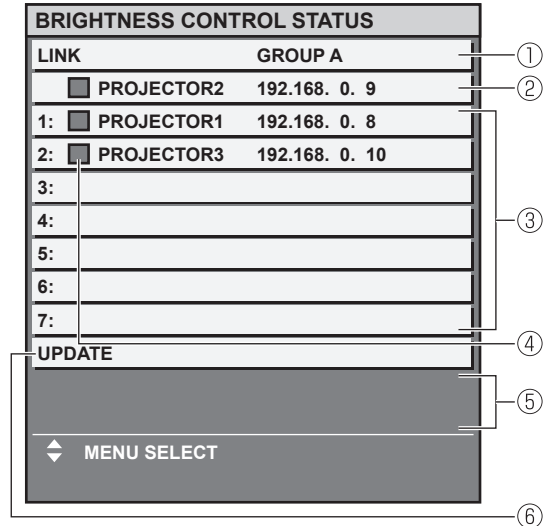

① The group to be linked is displayed.

② The name and IP address of this projector are displayed.

③ The projector name and IP address of the same group detected through the network are displayed.

④ The state is indicated by color.

GREEN : The brightness can be corrected by a significant margin.

YELLOW : The brightness can no longer be corrected by a significant margin.

RED : There is an error in brightness control.

⑤ An error message is displayed.

⑥ The information is updated.

If the message of [Failed to apply BRIGHTNESS CONTROL to some projectors.] is displayed, the projectors indicated in red are not linked.

Press ▲▼ to select a projector indicated in red, then press <ENTER> button to display the details of the error.

● Details of error

Error message	Remedial measure
[Exceed maximum number of projectors.]	<ul style="list-style-type: none"> • Limit number of projectors in same group to 8. • When linking 9 or more projectors, use a computer and the [Multi Projector Monitoring & Control Software].
[Please check the COMMAND CONTROL setting.]	<ul style="list-style-type: none"> • Turn [ON] the [COMMAND CONTROL] on the on-screen menu [NETWORK CONTROL] for the projector with the error display. • Set [COMMAND PORT] of [NETWORK CONTROL] of all linked projectors to the same value.
[Please check the USER NAME and PASSWORD in the COMMAND CONTROL setting.]	<ul style="list-style-type: none"> • Set the [USER NAME] and [PASSWORD] for the administrator authority for [WEB CONTROL] of all the linked projectors to the same text string.
[Cannot apply BRIGHTNESS CONTROL. Please check projector status.]	<ul style="list-style-type: none"> • Projector is in standby state. Turn on power.
[Brightness Sensor Error]	<ul style="list-style-type: none"> • There is a fault in the brightness sensor. If the fault is not corrected by turning the power off and back on, consult your dealer.

Note

- If the linked projectors are not listed, check the following.
 - The devices on the network all have different IP addresses.
 - The LAN cable is connected correctly. (➡page 96)
 - The sub-nets of the projectors are the same.
 - The [LINKS] are set in the same group.
- For changing the projector name, refer to “NETWORK SETUP” of “NETWORK menu” (➡page 95) or “■Network config page” (➡page 107).

● When [MODE] of brightness control is set to [PC]

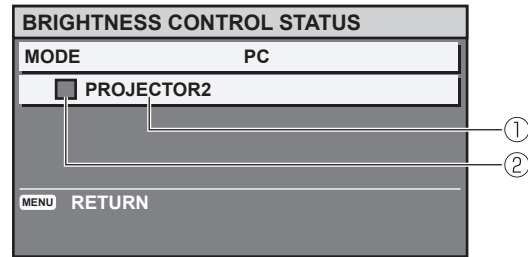

- ① The name of this projector is displayed.
- ② The state is indicated by color.
 - GREEN : The brightness can be corrected by a significant margin.
 - YELLOW : The brightness can no longer be corrected by a significant margin.
 - RED : There is an error in brightness control.

■ Example of adjustment procedure for brightness control

The following is an example of adjustment procedure for linking the brightness of 8 projectors that form a network.

- 1) **Connect all the projectors to the hub using the LAN cables. (➡page 96)**
- 2) **Turn on the power in all projectors.**
- 3) **Ensure [LAMP SELECT] of all the projectors are either all set to [DUAL] or all set to [SINGLE].**
- 4) **Set [MODE] of [BRIGHTNESS CONTROL SETUP] to [OFF], and select [APPLY].**
- 5) **Set [SUBNET MASK] of all the projectors to the same value and set their [IP ADDRESS] to different values so that network communication can be performed.**
- 6) **Wait at least 8 minutes until the lamp power stabilizes.**
- 7) **Set all the items in the [PICTURE] menu of all the projectors to the same value.**
- 8) **To match the color, adjust [COLOR MATCHING].**

PROJECTOR SETUP menu

- 9) Display the internal test pattern [ALL WHITE] on all projectors.
- 10) Set [BRIGHTNESS CONTROL GAIN] of all projectors to 100 %.
- 11) Set [BRIGHTNESS CONTROL GAIN] of the darkest projector to 90 %.
- 12) Adjust [BRIGHTNESS CONTROL GAIN] of the other projectors to that of the projector that was set to 90 %.
- 13) Set [MODE] of [BRIGHTNESS CONTROL SETUP] of all projectors to [AUTO] and set [LINK] to [GROUP A].
- 14) [APPLY] [BRIGHTNESS CONTROL SETUP] of all projectors and press <ENTER> button.
 - Brightness control will commence.

Note

- The brightness is corrected automatically each time the lamps are turned on using the power switch etc.
- If the brightness fluctuates significantly or the lamp has been replaced, re-adjust the brightness control.

STANDBY MODE

You can select the electrical consumption while in standby mode.

- 1) Press ▲ ▼ to select [STANDBY MODE].
- 2) Press ◀ ▶ to switch [STANDBY MODE].
 - The setting will change as follows each time ◀ ▶ is pressed.



Note

- With [ECO] setting, NETWORK function, RS-232C output and some of RS-232C commands are not available. When switch on the projector, projection will start about 10 seconds late.

SCHEDULE

This sets the command execution schedule for each day of the week.

How to enable the SCHEDULE function

- 1) Press ▲ ▼ to select [SCHEDULE].
- 2) Press ◀ ▶ to switch [SCHEDULE].
 - The setting will change as follows each time ◀ ▶ is pressed.



Note

- If [SCHEDULE] is set to [ON], the setting for [STANDBY MODE] is automatically set to [NORMAL] and cannot be changed. Even if [SCHEDULE] is then set to [OFF] when in this state, the setting of [STANDBY MODE] remains at [NORMAL].

How to assign a program

- 1) With [SCHEDULE] switched to [ON], press <ENTER> button.
 - The [SCHEDULE] screen will be displayed.
- 2) Select and assign program to each day of week.
 - Press ▲ ▼ to select a day of week and press ◀ ▶ to select a program number.
 - You can set the program from No.1 to No.7. “- -” indicates that the program number has not been set yet.

How to set a program

You can set up to 16 commands to each program.

- 1) On the [SCHEDULE] screen, press ▲ ▼ to select [PROGRAM EDIT].
- 2) Press ◀ ▶ to select a program number to be set and press <ENTER> button.
- 3) Press ▲ ▼ to select a command number and press <ENTER> button.
 - You can change the page using ◀ ▶.

- 4) Press ▲▼ to select [TIME] or [COMMAND] and change the setting according to the instructions of the menu.

TIME	Set the time at which the command will be executed using ▲▼ or numeral buttons.
COMMAND	<p>Select a command to execute at the set time from the following.</p> <ul style="list-style-type: none"> • POWER ON • STANDBY • SHUTTER OPEN • SHUTTER CLOSE • INPUT RGB1 • INPUT RGB2 • INPUT VIDEO • INPUT S-VIDEO • INPUT DVI-D • INPUT HDMI • INPUT SDI * • LAMP POWER HIGH • LAMP POWER LOW • LAMP DUAL • LAMP SINGLE • P IN P OFF • P IN P USER1 • P IN P USER2 • P IN P USER3

*: PT-DZ110XE/PT-DS100XE only

- 5) Press ▲▼ to select [STORE] and press <ENTER> button.

Note

- If you try to register a setting that would cause the lamp to flash for a short time, an error message will be displayed on the screen. Set the [TIME] and [COMMAND] again.
- To delete a command which has been set, press <DEFAULT> button.
- If multiple commands have been set for the same time, they are executed in chronological order starting from the smallest command number.
- The setting time operates under the local time. (▶page 85)
- If an operation is executed with the remote control or control panel of the projector or with a control command before the command set in the schedule is executed, the command set with this function may not be executed.

RS-232C

This sets the communication parameters at the serial terminals.

- 1) Press ▲▼ to select [RS-232C].
- 2) Press <ENTER> button.
 - The [RS-232C] screen will be displayed.
- 3) Press ▲▼ to select communication conditions.
- 4) press ◀▶ to change the setting.

Note

- Refer to “Serial terminal” (▶page 118).

■ Selecting items in [EMULATE]

When using the control commands for one of our projectors that you have previously purchased to control this projector using a computer via its serial input terminal, set up the EMULATE function as follows. This will allow you to use the control software etc. designed for our existing projectors.

1. Select [EMULATE] in step 3).
2. Press <ENTER> button.
3. Press ▲▼ to select the required item.
4. Press <ENTER> button.

● DEFAULT	DZ110 Series, DS100 Series, DW90 Series, D5000 Series, D6000 Series, DW6300 Series, DZ6700 Series, DZ6710 Series
D9610 SERIES	D9510 Series, D9610 Series, D9500 Series, D9600 Series, D8500 Series, D8600 Series
D7700 SERIES	D7500 Series, D7600 Series, D7700 Series, DW7000 Series
L6500 SERIES	L6500 Series, L6510 Series, L6600 Series

■ About [EMULATE SETTING]

This sets which input signal can be selected using the input signal change command when a projector of a specific model is used with the emulate function.

1. Select [EMULATE SETTING] in step 3).
2. Press <ENTER> button.
 - The [EMULATE SETTING] screen will be displayed.

● When the D9610 Series is selected

1. Press ▲▼ to select input signal [VIDEO], [S-VIDEO], [RGB1], [DVI-D] or [SDI].
 - [RGB2] and [HDMI] cannot be selected.
 - [SDI] is not shown for PT-DW90XE.
2. Press ◀▶ to select the input signal change command to be assigned to the selected input signal.
 - Selectable input signal change commands
When RGB1 is selected:
[INPUT1], [INPUT2], [INPUT3], [INPUT RGB], [NONE]
For all other instances:
[INPUT1], [INPUT2], [INPUT3], [NONE]
 - The same input signal change command cannot be assigned to multiple input signals.

PROJECTOR SETUP menu

●When the D7700 Series is selected

1. Press ▲▼ to select input signal [DVI-D] or [SDI].

- [RGB1], [RGB2], [VIDEO], [S-VIDEO] and [HDMI] cannot be selected. Since [RGB1], [RGB2], [VIDEO], and [S-VIDEO] are already installed on the projector, another input signal change command cannot be assigned.
- [SDI] is not shown for PT-DW90XE.

2. Press ◀▶ to select the input signal change command to be assigned to the selected input signal.

- The signal change command can be selected to either [AUX] or [NONE].
- The same input signal change command cannot be assigned to both [DVI-D] and [SDI].

STATUS

Displays the status of the projector.

1) Press ▲▼ to select [STATUS].

2) Press <ENTER> button.

3) Press ◀▶ to move to the next page.

INPUT	Displays the input selection state.
SIGNAL NAME	Displays the input signal name.
SIGNAL FREQUENCY	Displays the frequency of the input signal.
PROJECTOR RUNTIME	Displays the projector runtime.
LAMP1 *1	Displays the lighting time of LAMP1.
LAMP2 *1	Displays the lighting time of LAMP2.
INTAKE AIR TEMP.	Displays the intake air temperature of the projector.
OPTICS MODULE TEMP.	Displays the temperature inside the projector.
AROUND LAMP TEMP.	Displays the temperature around the lamp of the projector.
REMAINING FILTER QUANTITY *2	Displays the filter remaining quantity.
PROJECTOR TYPE	Displays type of projector.
SERIAL NUMBER	Displays the serial number of the projector.

LAMP UNIT MODEL NO.	Displays the component number of the lamp unit.
LAMP1 SERIAL NUMBER	Displays the serial number for lamp1.
LAMP2 SERIAL NUMBER	Displays the serial number for lamp2.
MAIN VERSION	Displays the main version of the firmware of the projector unit.
SUB VERSION	Displays the sub version of the firmware of the projector unit.
NETWORK VERSION	Displays the network version of the projector unit.
EMULATE	Displays the set emulate mode.
ON COUNT	<ul style="list-style-type: none"> ● POWER ON TIMES : Displays the number of times the power has been turned on. ● LAMP1 ON : Displays the number of times LAMP1 has been lit. ● LAMP2 ON : Displays the number of times LAMP2 has been lit.
LAMP1	Displays the lighting time of LAMP1. (HIGH or LOW)
LAMP2	Displays the lighting time of LAMP2. (HIGH or LOW)
NUMBER OF ENTRY SIGNAL	Displays the number of registered signals.
REMOTE2 STATUS	Displays [REMOTE 2 IN] control status.
AC VOLTAGE	Displays the AC voltage state.

*1 :

$$\left[\begin{array}{l} \text{Lamp replacement time} = \\ \text{LAMP POWER [HIGH] lighting time} + \\ \text{(LAMP POWER [LOW] lighting time} \times 3 \div 4) \end{array} \right]$$

*2 : REMAINING FILTER QUANTITY

If the remaining quantity of ACF becomes 8%, the status display turns yellow. If the remaining quantity becomes 0%, the display turns red. If the residual filter indication becomes yellow, the remaining usable time is about 200 hours. The time of 200 hours is for reference only. It depends on the usage environment.

NO SIGNAL SHUT-OFF

You can set the timer to switch off the power of the projector after a certain period of time automatically when no signal is detected.

- 1) Press ▲▼ to select [NO SIGNAL SHUT-OFF].
- 2) Press ◀▶ to switch [NO SIGNAL SHUT-OFF].

DISABLE	Deactivate the NO SIGNAL SHUT-OFF.
10MIN. - 90MIN.	At intervals of 10 minutes.

REMOTE2 MODE

You can customize the [REMOTE 2 IN] terminal function.

- 1) Press ▲▼ to select [REMOTE2 MODE].
- 2) Press ◀▶ to switch [REMOTE2 MODE].
 - The setting will change as follows each time ◀▶ is pressed.



DEFAULT	The pin assignment of the [REMOTE 2 IN] terminal is used as the projector default setting. (▶page 121)
USER	This is used for changing the settings for the REMOTE2 terminal. Any settings you make for pins 2 to 8 become valid once you press <ENTER> button.
L6500 SERIES	Use the setting for L6500-compatible REMOTE 2 terminal.

FUNCTION BUTTON

You can assign a certain menu function to the <FUNCTION> button as shortcut.

- 1) Press ▲▼ to select [FUNCTION BUTTON].
- 2) Press <ENTER> button.
 - The [FUNCTION BUTTON] screen will be displayed.
- 3) Press ▲▼ to select a function.

DISABLE	Deactivate the <FUNCTION> button.
P IN P	Changes between OFF/USER1/USER2/USER3 in P IN P. (▶page 88)
SUB MEMORY	Displays the assigned SUB MEMORY LIST. (▶page 91)
SYSTEM SELECTOR	Switches [SYSTEM SELECTOR] options. (▶page 58)
SYSTEM DAYLIGHT VIEW	Switches [SYSTEM DAYLIGHT VIEW] options. (▶page 56)
FREEZE	Freezes the image.
WAVEFORM MONITOR *	Displays the waveform of the input signal.

*: PT-DZ110XE only

- 4) Press <ENTER> button.

DATE AND TIME

This lets you set the time zone and the current date and time for the projector's internal clock.

Setting the TIME ZONE

- 1) Press ▲▼ to select [DATE AND TIME].
- 2) Press <ENTER> button.
- 3) Press ▲▼ to select [TIME ZONE].
- 4) Press ◀▶ to switch [TIME ZONE].

Adjusting the date and time manually

- 1) Press ▲▼ to select [DATE AND TIME].
- 2) Press <ENTER> button.
- 3) Press ▲▼ to select [ADJUST CLOCK].

PROJECTOR SETUP menu

- 4) Press <ENTER> button.
 - The [ADJUST CLOCK] screen will be displayed.
- 5) Press ▲ ▼ to select the item to be set, and press ◀ ▶ to set the local time.
- 6) Press ▲ ▼ to select [APPLY], and press <ENTER> button.
 - This completes setting of the time.

■ Adjusting the date and time automatically

- 1) Press ▲ ▼ to select [DATE AND TIME].
- 2) Press <ENTER> button.
- 3) Press ▲ ▼ to select [ADJUST CLOCK].
- 4) Press <ENTER> button.
 - The [ADJUST CLOCK] screen will be displayed.
- 5) Press ▲ ▼ to select [NTP SYNCHRONIZATION] and press ◀ ▶ to switch to [ON].
 - The setting will change as follows each time ◀ ▶ is pressed.



- 6) Press ▲ ▼ to select [APPLY], and press <ENTER> button.
 - This completes setting of the time.

Note

- To set the date and time automatically, the projector must be connected to the network.
- If synchronization with the NTP server fails just after [NTP SYNCHRONIZATION] is turned [ON], or if [NTP SYNCHRONIZATION] is turned [ON] while the NTP server is not set, [NTP SYNCHRONIZATION] will return to [OFF].
- Access the projector via a web browser to set the NTP server. (➔page 107)

LENS CALIBRATION

This automatically sets the limit value of the lens shift and the home position of the projector.

- 1) Press ▲ ▼ to select [LENS CALIBRATION].
- 2) Press <ENTER> button.
 - A confirmation message will be displayed.
- 3) Press ◀ ▶ to select [OK], and press <ENTER> button.
 - To stop, select [CANCEL].
 - The lens will move vertically and horizontally, and the limit value of the lens shift and home position are set automatically.
 - The lens will stop, completing the calibration.

Note

- While lens calibration is being executed, a message [PROGRESS] appears on the menu. The calibration cannot be canceled halfway.
- If the lens calibration has been correctly executed, a message [COMPLETE] will appear. If the calibration has not been correctly executed, a message [INCOMPLETE] will appear.

FILTER COUNTER RESET

After you replaced the Auto Cleaning Filter (ACF), [REMAINING FILTER] of [STATUS] need to be reset to [0].

- 1) Press ▲ ▼ to select [FILTER COUNTER RESET].
- 2) Press <ENTER> button.
 - The [RESET FILTER COUNTER?] screen will be displayed.
- 3) Press ◀ ▶ to select [OK], and press <ENTER> button.

Note

- For replacing ACF unit, refer to “■Procedure of ACF unit replacement” (➔page 110).
- If the filter has not been installed, [OK] cannot be selected.
- The filter is wound during the resetting operation. Some sound may be produced during the winding operation.

SAVE ALL USER DATA

This saves various setting values as a backup to the internal memory of the projector.

- 1) Press ▲▼ to select [SAVE ALL USER DATA].
- 2) Press <ENTER> button.
 - The [SECURITY PASSWORD] screen will be displayed.
- 3) Enter the password set for the [SECURITY PASSWORD].
 - The confirmation screen will be displayed.
- 4) Press ◀▶ to select [OK], and press <ENTER> button.

LOAD ALL USER DATA

This loads various setting values that were saved as a backup to the internal memory of the projector.

- 1) Press ▲▼ to select [LOAD ALL USER DATA].
- 2) Press <ENTER> button.
 - The [SECURITY PASSWORD] screen will be displayed.
- 3) Enter the password set for the [SECURITY PASSWORD].
 - The confirmation screen will be displayed.
- 4) Press ◀▶ to select [OK], and press <ENTER> button.

Note

- If this is executed, the projector enters a standby state in order to reflect the setting values.

INITIALIZE

This returns various setting values to their factory default settings.

- 1) Press ▲▼ to select [INITIALIZE].
- 2) Press <ENTER> button.
 - The [SECURITY PASSWORD] screen will be displayed.
- 3) Enter the password set for the [SECURITY PASSWORD].
 - The [INITIALIZE] screen will be displayed.
- 4) Press ▲▼ to select the desired initialize item.

ALL USER DATA	All setting values including [ENTRY SIGNAL], [NETWORK/E-MAIL], and [LOGO IMAGE] are returned to their factory default values. The projector enters a standby state in order to reflect the setting values.
ENTRY SIGNAL	All setting values saved for each of the input signals are cleared. To clear just some registered signals, perform the procedure described in “Deleting a registered data” (▶ page 90).
NETWORK/E-MAIL	All setting values in [NETWORK SETUP] and [E-mail setup] settings will return to factory settings.
LOGO IMAGE	The registered image data for [LOGO1] will return to factory settings.

- 5) Press <ENTER> button.
 - The confirmation screen will be displayed.
- 6) Press ◀▶ to select [OK], and press <ENTER> button.

SERVICE PASSWORD

This function is used by a service person.

P IN P menu

- See “Navigating through the menu” (➔page 50).
- See “MAIN MENU” and “SUB MENU” (➔page 51).

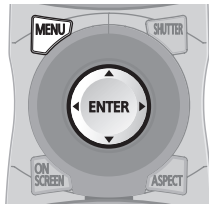

Using the P IN P function

Two videos can be projected simultaneously by placing a separate small sub screen within the main screen.

- 1) Press ▲▼ to select [P IN P].
- 2) Press <ENTER> button.
 - The [P IN P] screen will be displayed.
- 3) Press ▲▼ to select [P IN P MODE], and press <ENTER> button.
 - The [P IN P MODE] screen will be displayed.
- 4) Press ▲▼ to select a function.

OFF	The P IN P function is not used.
USER1	The P IN P function is used with the settings that were set in [Setting the P IN P function].
USER2	
USER3	

- 5) Press <ENTER> button.

Setting the P IN P function

The settings of the P IN P function can be saved to [USER1], [USER2], and [USER3].

- 1) Select one of [USER1], [USER2], and [USER3] modes in Step 4) of “Using the P IN P function”, and press <ENTER> button.
 - The setting screen for the selected mode is displayed.

- 2) Press ▲▼ to select the desired setting item, and press <ENTER> button.

- The sub menu for the selected item appears.

MAIN WINDOW	The input terminal for the main window is displayed. (Press ▲▼ to select an item, and press <ENTER> button to switch to the item.) SIZE : The user can specify the display size of the main window between 10 % and 100 %. POSITION : The user can specify the display position of the main window on the screen.
SUB WINDOW	The input terminal for the subwindow is displayed. (Press ▲▼ to select an item, and press <ENTER> button to switch to the item.) SIZE : The user can specify the display size of the sub window between 10 % and 100 %. POSITION : The user can specify the display position of the subwindow on the screen. CLOCK PHASE : Set this if the pictures flicker or their outlines blur when the subwindow is RGB1 or RGB2. (Set between 0 and 63)
FRAME LOCK	The user can select the window to apply frame lock. (Press ◀▶ to switch windows.) [MAIN WINDOW] : Frame lock is set for the input signals specified for the main window. [SUB WINDOW] : Frame lock is set for the input signals specified for the subwindow.
TYPE	The user can select the window that is displayed by priority when two windows overlap. (Press ◀▶ to switch windows.) [MAIN WINDOW] : The main window is displayed by priority. [SUB WINDOW] : The subwindow is displayed by priority.

Note

- The P IN P function is not available depending on the input signals and the selected input terminals. Refer to “Two window display combination list” (➔page 122) for details.
- The main window’s picture adjustment values such as the picture mode, gamma selection and color temperature setting for the main window will be applied.
- In the normal screen (when the menu is not displayed), the ◀▶ buttons can be used to switch the size and position of the main window and subwindow when the P IN P function is on.

TEST PATTERN menu

- See “Navigating through the menu” (➔page 50).
- See “MAIN MENU” and “SUB MENU” (➔page 51).

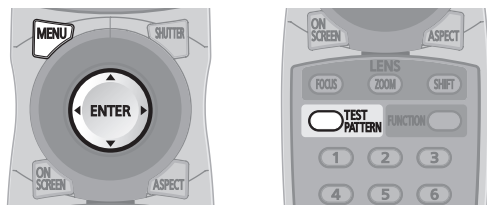

TEST PATTERN

Results of adjustment of the position, size and other factors are not reflected in test patterns. Ensure the input signal is displayed before performing various kinds of setting.

1) Press ◀▶ to select the required test pattern.

■ Cycle of displayed internal test patterns

The setting will change as follows each time ◀▶ is pressed.

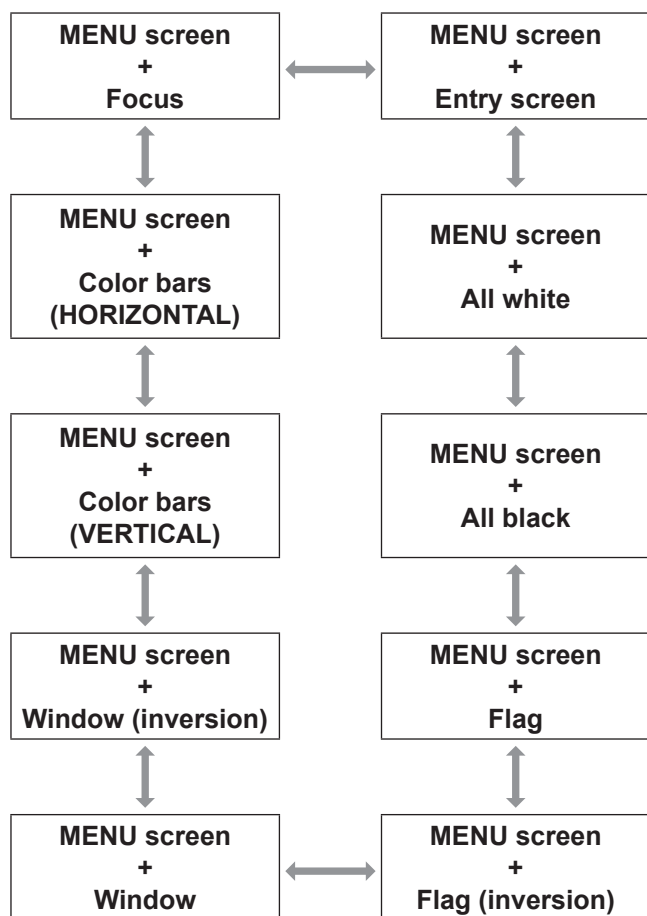

SIGNAL LIST menu

- See “Navigating through the menu” (➔page 50).
- See “MAIN MENU” and “SUB MENU” (➔page 51).

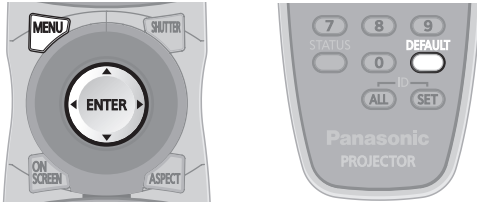

REGISTERED SIGNAL STATUS

- The name can be set for each sub memory.
- MEMORY NO. : A1 (1-2)

Sub memory number

When the address number (A1, A2, ...H7, H8) signal is registered

Registering a signal to the list

When a new format input signal is applied to the projector, press <MENU> button to register to the SIGNAL LIST.

Note

- You can register data up to 96 in total number of the signal data and any corresponding sub memory data.
- The memories are numbered over 12 pages (A to L: 8 data items can be registered on each page), and the data is registered in the unused memory with the lowest number. If all the memories are used, the data of the old signals is overwritten in sequence.
- The names of the registered data are automatically determined by the input signals and memory numbers.
- If a menu is being displayed, the new signals will be registered at the instant they are input.

Renaming a registered data

- 1) Press ▲▼◀▶ to select the required signal data.
- 2) Press <ENTER> button.
 - The [REGISTERED SIGNAL STATUS] screen will be displayed.
 - Displays the character list.
 - Press <MENU> button to return to the [REGISTERED SIGNAL LIST] screen.
- 3) Press <ENTER> button.
 - The [RENAME] screen will be displayed.
- 4) Press ▲▼◀▶ to select characters and press <ENTER> button to input them.
- 5) Press ▲▼◀▶ to select [OK], and press <ENTER> button.
 - The [REGISTERED SIGNAL LIST] screen will be displayed.
 - Press ▲▼◀▶ to select [CANCEL] and press <ENTER> button to return to the [REGISTERED SIGNAL LIST] without any change.

Deleting a registered data

- 1) Press ▲▼◀▶ to select the required signal data.
- 2) Press <DEFAULT> button.
 - The [ENTRY SIGNAL CLEAR] screen will be displayed.
 - Press <MENU> button to cancel and return to the [REGISTERED SIGNAL LIST] without any change.
- 3) Press <ENTER> button.
 - Displays [REGISTERED SIGNAL LIST] and confirm the data is deleted.

Managing the sub memory list

You can restore the sub memory data when using signals from the same input source. Sub memory data contains the setting information of screen and image adjustments, such as BRIGHTNESS, CONTRAST or ASPECT.

■ Registering the current settings to the list

- 1) **In the normal screen (when the menu is not displayed), press ◀▶ button.**
 - The signal must be registered before creating a sub memory data of the signal.
 - Displays the list of corresponding sub memory data to the signal.
- 2) **Press ▲▼◀▶ to select the required sub memory data.**
- 3) **Press <ENTER> button.**
 - The [SIGNAL NAME] screen will be displayed.
- 4) **Press <ENTER> button.**

Note

- For renaming a registered data, follow the same procedure (steps 4 - 5) of "Renaming a registered data" (➔page 90).

■ Displaying the sub memory list and restoring the settings

- 1) **In the normal screen (when the menu is not displayed), press ◀▶ button.**
 - The [SUB MEMORY LIST] screen will be displayed.
- 2) **Press ▲▼◀▶ to select the required sub memory data, and press <ENTER> button.**
 - The [REGISTERED SIGNAL STATUS] screen will be displayed.
- 3) **Press <ENTER> button.**
 - Restores the settings in the data.

■ Deleting a sub memory data

- 1) **In the normal screen (when the menu is not displayed), press ◀▶ button.**
 - The [SUB MEMORY LIST] screen will be displayed.
- 2) **Press ▲▼◀▶ to select the required sub memory data, and press <ENTER> button.**
 - The [REGISTERED SIGNAL STATUS] screen will be displayed.

- 3) **Press <DEFAULT> button.**
 - Displays the [SUB MEMORY LIST] with change.
 - You can return to the previous step by pressing <MENU> button.

SECURITY menu

- See “Navigating through the menu” (➡page 50).
- See “MAIN MENU” and “SUB MENU” (➡page 51).
- When you apply to the [SECURITY] menu before you change the password to your original, perform to input the following factory default password operation.
Press **▲▼◀▶** and **<ENTER>** button.

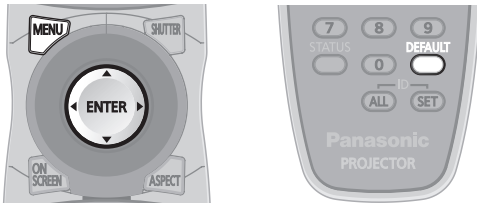

Attention

- When you apply to the SECURITY menu after you change the password to your original in the [SECURITY PASSWORD CHANGE] menu, input the original password operation.

Note

- Only asterisks * will appear on the screen to represent the actual characters of the password when the password is entered.

SECURITY PASSWORD

The [SECURITY PASSWORD] screen can be displayed when the power has been turned on. If the correct password is not entered, operations other than using **<STANDBY (⏻)>** button and **<SHUTTER>** button and adjusting the lens will not be possible.

- 1) Press **▲▼** to select [SECURITY PASSWORD].
- 2) Press **◀▶** to switch [SECURITY PASSWORD].
 - The setting will change as follows each time **◀▶** is pressed.



OFF	Deactive
ON	Active

Note

- [PASSWORD] is set to [OFF] by default and when initialized.
- Change the SECURITY PASSWORD regularly and make it uneasy to guess.
- The security password becomes valid when setting of the security password is turned [ON] and then the MAIN POWER switch is turned off.

SECURITY PASSWORD CHANGE

The password can be changed.

- 1) Press **▲▼** to select [SECURITY PASSWORD CHANGE].
- 2) Press **<ENTER>** button.
 - The [SECURITY PASSWORD CHANGE] screen will be displayed.
- 3) Press **▲▼◀▶** and numeral keys to set the password.
 - Up to 8 buttons can be set as the password.
- 4) Press **<ENTER>** button.
- 5) For the purposes of confirmation, enter the password again.
- 6) Press **<ENTER>** button.

Note

- Only asterisks * will appear on the screen to represent the actual characters of the password when the password is entered.
- If the password input second does not match with the password input first, an error message is displayed. In this case, input the correct password again.
- When numerals are used in the SECURITY PASSWORD, initialization of the security password will be necessary if the remote control is lost. For the method of initialization, consult your dealer.

DISPLAY SETTING

You can set your original text, such as company name or URL information, to display regularly on the projected image while projecting.

- 1) Press ▲▼ to select [DISPLAY SETTING].
- 2) Press ◀▶ to switch [DISPLAY SETTING].
 - The setting will change as follows each time ◀▶ is pressed.



OFF	The text display is disabled.
TEXT	The text display is enabled.
LOGO1	The picture registered by the user will be projected.

Note

- Separate software [Logo Transfer Software] is required in order to create the pictures to use for [LOGO1]. Consult your dealer.

TEXT CHANGE

You can enter your original text to be displayed when [DISPLAY SETTING] is turned [TEXT].

- 1) Press ▲▼ to select [TEXT CHANGE].
- 2) Press <ENTER> button.
 - The [TEXT CHANGE] screen will be displayed.
- 3) Press ▲▼◀▶ to select characters and press <ENTER> button to input them.
- 4) Press ▲▼◀▶ to select [OK], and press <ENTER> button.
 - The text is now changed.

MENU LOCK

You can lock <MENU> button function and the password will be asked to display the menu every time.

- 1) Press ▲▼ to select [MENU LOCK].
- 2) Press ◀▶ to switch [MENU LOCK].
 - The setting will change as follows each time ◀▶ is pressed.



OFF	Deactivate the [MENU LOCK] system.
ON	Activate the [MENU LOCK] system.

Note

- Once [MENU LOCK] is set to [ON], you cannot use <MENU> button unless you input the correct password.
- The [MENU LOCK] is set to [OFF] by default and when initialized.
- The unlock state is maintained until the projector is set to the standby mode.

MENU LOCK PASSWORD

You can change the password for [MENU LOCK] system to your original.

- 1) Press ▲▼ to select [MENU LOCK PASSWORD].
- 2) Press <ENTER> button.
 - The [MENU LOCK PASSWORD] screen will be displayed.
- 3) Press ▲▼◀▶ to select characters and press <ENTER> button to input them.
- 4) Press ▲▼◀▶ to select [OK], and press <ENTER> button.
 - To stop, select [CANCEL].

Attention

- The factory default password is "AAAA".
- When the projector is initialized, the password will be changed to the factory default setting, "AAAA".
- Change the MENU LOCK PASSWORD regularly and make it uneasy to guess.

SECURITY menu

CONTROL DEVICE SETUP

Control from the remote control and main unit controls can be restricted.

- 1) Press **▲ ▼** to select **[CONTROL DEVICE SETUP]**.
- 2) Press **<ENTER>** button.
 - The **[CONTROL DEVICE SETUP]** screen will be displayed.
- 3) Press **▲ ▼** to select **[CONTROL PANEL]** or **[REMOTE CONTROLLER]**.
- 4) Press **<ENTER>** button.
 - **[CONTROL PANEL]** screen or **[REMOTE CONTROLLER]** screen will be displayed.

■ CONTROL PANEL

- Restriction of control from the main unit controls can be set.

ENABLE	Enables control from the main unit controls.
DISABLE	Disables control from the main unit controls.

■ REMOTE CONTROLLER

- Restriction of control from the remote control can be set.

ENABLE	Enables control from the remote control.
DISABLE	Disables control from the remote control.

- 5) Press **▲ ▼** to select **[ENABLE]** or **[DISABLE]**, and press **<ENTER>** button.
 - The confirmation screen will be displayed.
- 6) Press **◀ ▶** to select **[OK]**, and press **<ENTER>** button.

Note

- If an attempt is made to control the projector from the remote control or main unit controls when **[DISABLE]** is set, the **[SECURITY PASSWORD]** screen appears. To change a setting, enter the security password and change the operation setting.
- The **[SECURITY PASSWORD]** screen disappears if **<MENU>** button is pressed or no operation is performed for 10 seconds.
- If you **[DISABLE]** both of the **[CONTROL PANEL]** and **[REMOTE CONTROLLER]** buttons, you cannot return to the standby mode. Use this function with utmost care.
- If a setting is reflected, the on-screen menu disappears. To continue operation, press **<MENU>** button to display the main menu.

NETWORK menu

- See “Navigating through the menu” (➔page 50).
- See “MAIN MENU” and “SUB MENU” (➔page 51).

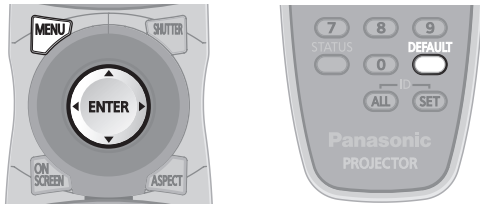

NETWORK SETUP

Make the initial network settings before using the network connection.

- 1) Press ▲▼ to select [NETWORK SETUP].
- 2) Press <ENTER> button.
 - The [NETWORK SETUP] screen will be displayed.
- 3) Press ▲▼ to select an item, and change the setting according to the instructions.

PROJECTOR NAME (Display of host name and setting)	Change as needed when using a DHCP server.
DHCP (DHCP client function)	Set [DHCP] item to [ON] when to acquire an IP address automatically using the DHCP server. Set to [OFF] if [DHCP] server is not used. Enter the IP address if DHCP server is not used.
IP ADDRESS (Display of IP address and setting)	Enter the IP address if DHCP server is not used.
SUBNET MASK (Displaying and setting the subnet mask)	If not using a DHCP server, enter the subnet mask.
DEFAULT GATEWAY (Display of gateway address and setting)	Enter the gateway address if DHCP server is not used.
STORE	Save the current network settings.

- 4) Press ▲▼ to select [STORE], and press <ENTER> button.

Note

- Before using the DHCP server, make sure the DHCP server is already functioning.
- For details of IP address, subnet mask, and gateway, ask the network administrator.

NETWORK CONTROL

This sets the network control method.

- 1) Press ▲▼ to select [NETWORK CONTROL].
- 2) Press <ENTER> button.
 - The [NETWORK CONTROL] screen will be displayed.
- 3) Press ▲▼ to select items, and press ◀▶ to change the setting.

WEB CONTROL	Set this to [ON] when you want to perform control with the Web browser.
PJLink CONTROL	Set this to [ON] when you want to perform control with the PJLink protocol.
COMMAND CONTROL *	Set to [ON] to control using the control command via the serial terminal. (➔page 120)
COMMAND PORT	Set the port number used for the command control.
STORE	Save the current network control settings.

*: If settings have been made without an administrator password of the Web browser control, add 2-byte “00” instead of STX, and a line-feed code (0Dh) instead of ETX. If settings have been made with an administrator password of the Web browser control, add a 32-byte hash value and “00” instead of STX and a line-feed code (0Dh) instead of ETX. The hash value is created by MD5 combining “admin1:”, password, “.” and random numbers. The random numbers are 8-byte values sent from the projector when connecting.

NETWORK STATUS

This displays the network status of the main unit.

- 1) Press ▲▼ to select [NETWORK STATUS].
- 2) Press <ENTER> button.
 - The [NETWORK STATUS] screen will be displayed.

NETWORK menu

Network connections

The projector is equipped with network functions, and web browser controls can be used to carry out the following operations from a computer.

- Projector settings and adjustments
- Projector status display
- Transmission of E-mail messages if there is a problem with the projector

Note

- A LAN cable is required to use the network function.

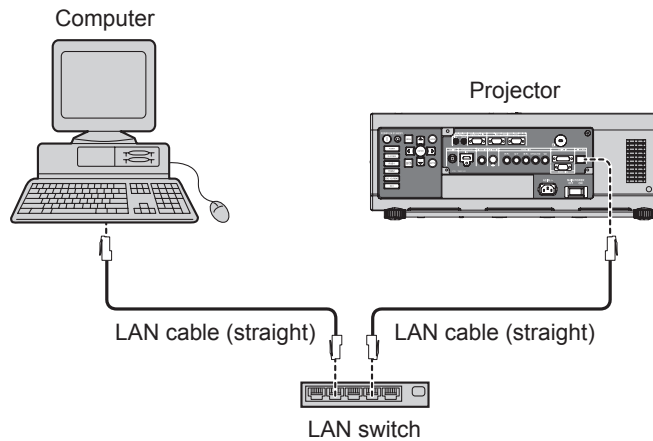

- A Web browser is required to use this function. Make sure that a Web browser is available in the system.
- Supported OS: Windows XP/Windows Vista/Windows 7, Mac OS X v10.4/v10.5/v10.6.
- Supported browser: Internet Explorer 6.0/7.0/8.0, Safari 2.0/3.0/4.0 (Mac OS).
- To use the E-mail function, communication with E-mail server must be established. Make sure that E-mail feature is available in your system.
- Use a straight insulated LAN cable which supports category 5 or above.
- The length of LAN cable must be 100 m or shorter.

Name and function of network function parts

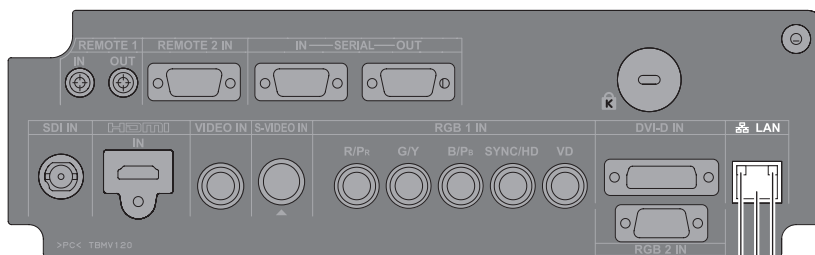

- LAN LINK/ACT lamp (green)
This lights when a LAN cable is connected and flashes when signals are being received or sent.
- LAN terminal (10BASE-T/100BASE-TX)
Connect LAN cable here.
- LAN10/100 lamp (yellow)
This lights when a 100BASE-TX connection is established.

Attention

- If the LAN terminal is touched by electrostatically charged hands (or body), failure may be caused by the discharge of static electricity.
Be careful not to touch metallic part of LAN terminal or LAN cable.
- Connect indoor equipment to the LAN.

Accessing from the Web browser

- 1) Activate the Web browser in the personal computer.
- 2) Enter the IP address set by the projector into the URL input field of the Web browser.
- 3) Enter your “User name” and “Password”.
 - The factory default settings are user1 (user privileges) or admin1 (administrator privileges) for the user name and panasonic (lowercase letters) for the password.

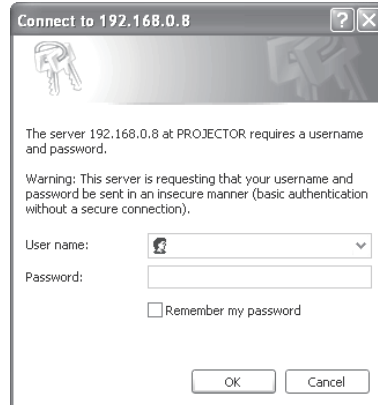

- 4) Click [OK] to display the Projector status page.

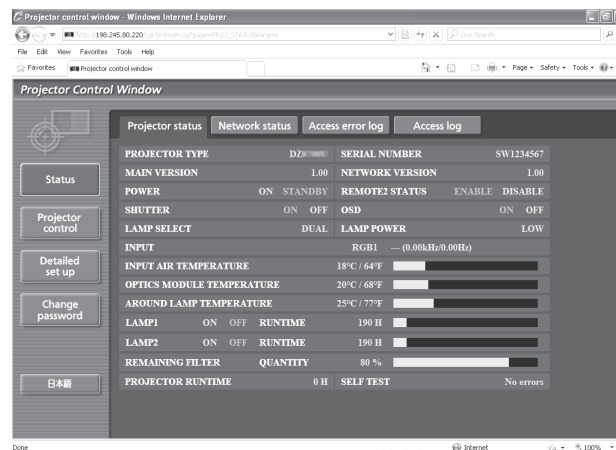

Note

- Avoid activating two or more Web browser simultaneously to work out setting or control actions.
- Change the password first of all.
- Administrator privileges enable the use of all functions. User privileges enable the use of only “Projector status”, “Error information”, “Network status”, “Basic control”, and “Change password”.
- If the password is incorrectly entered three times in a row, the lock is set for several minutes.

NETWORK menu

Change Password page

Click [Change password].

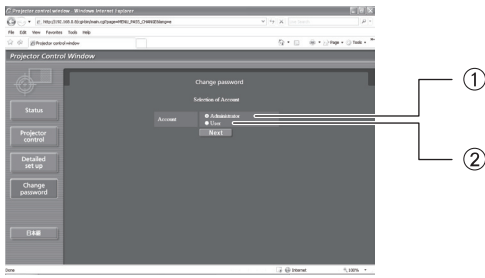

- ① Administrator
- ② User

Administrator mode

Administrator account

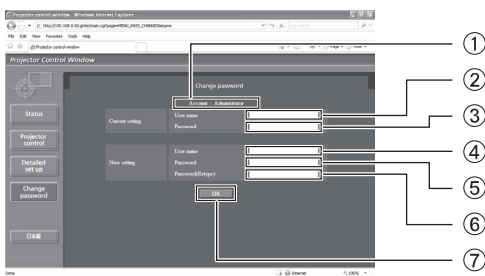

- ① Account
- ② Current user name input field
- ③ Current password input field
- ④ New user name input field
- ⑤ New password input field
- ⑥ New password input field (re-enter for confirmation)
- ⑦ Button for executing password change

User account

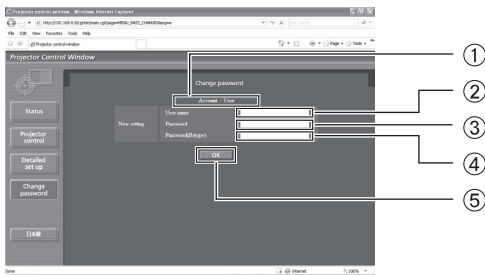

- ① Account
- ② New user name input field
- ③ New password input field
- ④ New password input field (re-enter for confirmation)
- ⑤ Button for executing password change

User mode

A user can change password only.

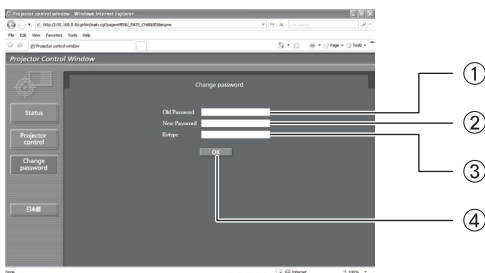

- ① Current password input field
- ② New password input field
- ③ New password input field (re-enter for confirmation)
- ④ Button for executing password change

Basic control page

To move from another page, click [Projector control], then [Basic control].

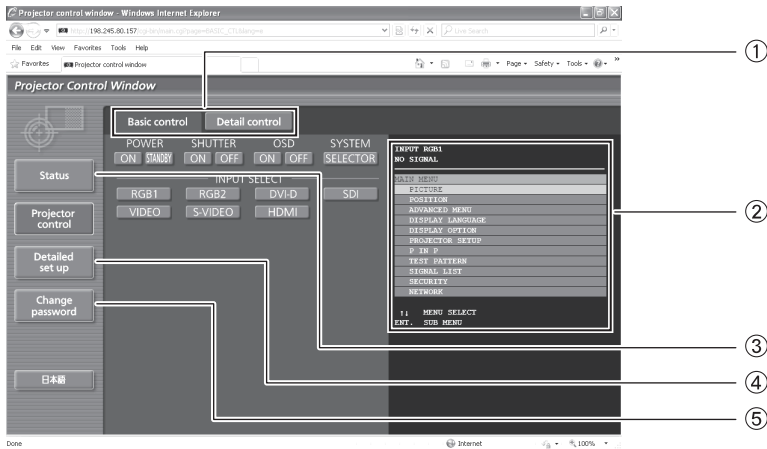

- ① Page selection tabs
Click these to switch pages.
- ② This displays the on-screen status. It is displayed even if the on-screen display of the projector is set to off.
- ③ Monitor information button
Click this item, and the status of the projector is displayed.
- ④ Detailed set up button
Click this item to display the advanced settings page.
- ⑤ Change password button

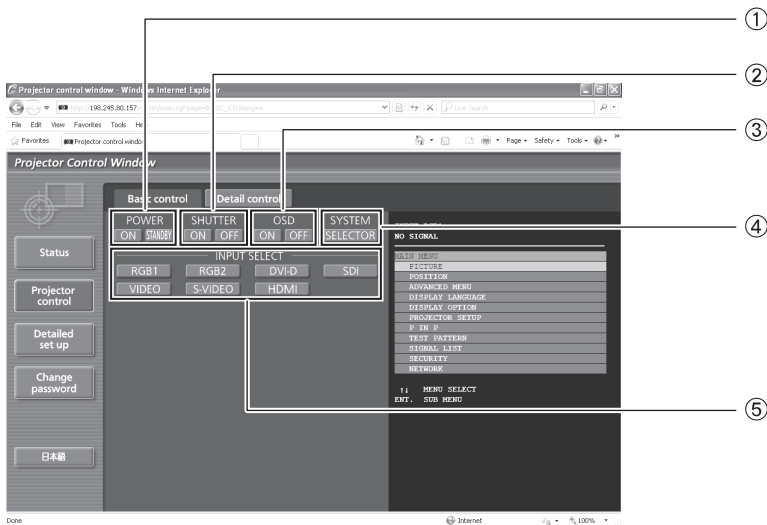

- ① Power On/Off control
- ② SHUTTER control
- ③ OSD (On-screen Display) display/nondisplay
- ④ System type switching
- ⑤ Use these to select the input signals.

NETWORK menu

Detail control page

Click [Projector control], then [Detail control] to display the Detail control page.

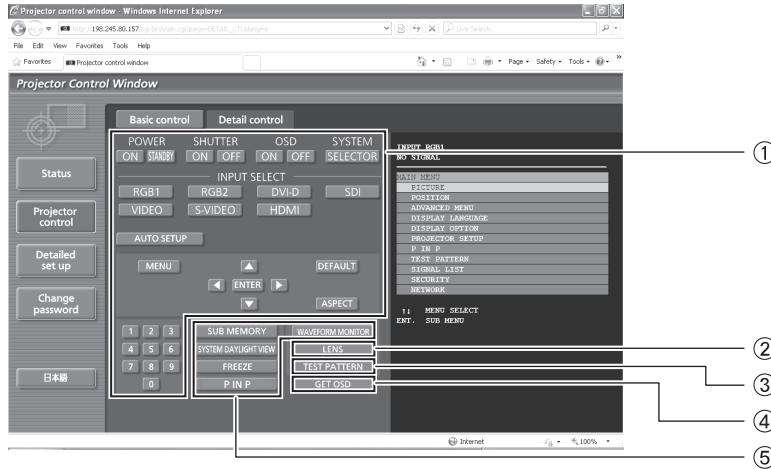

- ① Pressing these buttons controls the projector and updates the on-screen description on the right of the control page when control is finished.
- ② Lens adjustment
- ③ Test pattern display

- ④ This button updates the on-screen description on the right of the control page with the latest information.
- ⑤ Menu display

Projector status page

Click [Status], then [Projector status] to display the Status information page.

This page displays the projector statuses established for the items shown below.

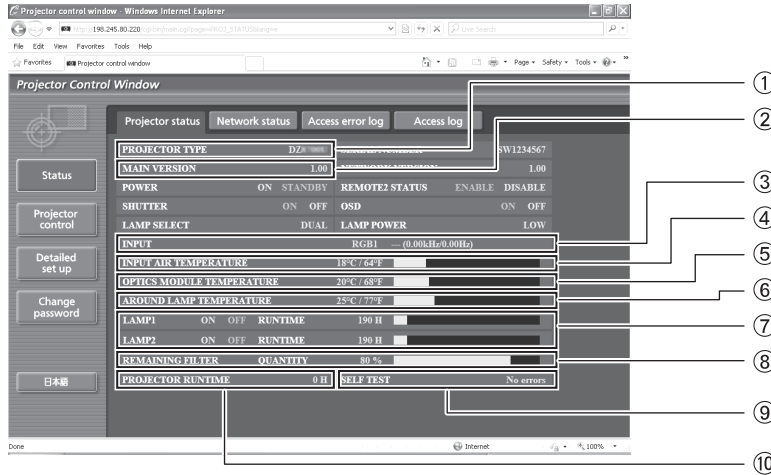

- ① Displays the type of projector.
- ② Displays the firmware version of the projector main unit.
- ③ Displays the input switching status.
- ④ Displays temperature of projector's intake air.
- ⑤ Displays temperature inside the projector.

- ⑥ Displays the AROUND LAMP TEMPERATURE.
- ⑦ Displays the lamp lit hours.
- ⑧ Displays the REMAINING FILTER QUANTITY.
- ⑨ Displays self-diagnosis information.
- ⑩ Displays used hours of the projector.

Error information page

When “Error (Detail)” is displayed on the status information screen, click it to display the error details.

- Depending on the nature of the error, the projector may be placed in the standby mode for its own protection.

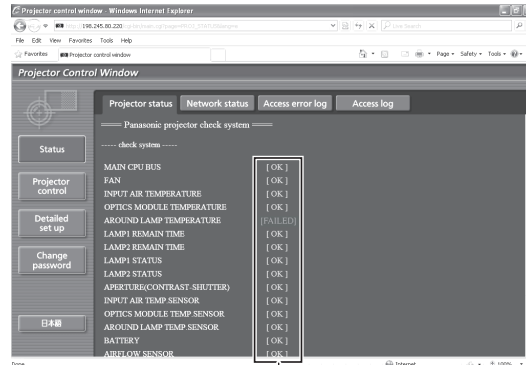
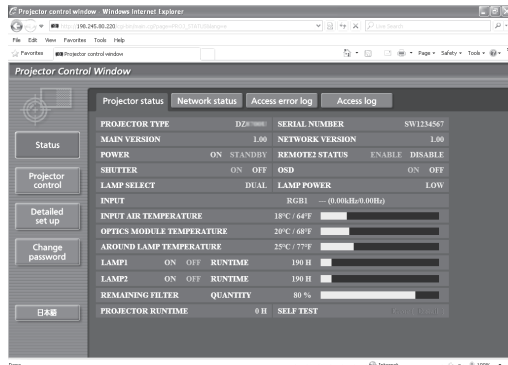

OK: Normal operation
 FAILED: Occurrence of trouble

When [FAILED] has appeared for an item

Parameter	Description
MAIN CPU BUS	Trouble has occurred in the microcomputer circuitry. Consult your dealer.
FAN	Trouble has occurred in the fan or its drive circuit. Consult your dealer.
INPUT AIR TEMPERATURE	The input air temperature is too high. It may be that the projector is being used in an operating environment where the temperature is high such as near a heating appliance.
OPTICS MODULE TEMPERATURE	The temperature inside the projector is high. It may be that the projector is being used in an operating environment where the temperature is high such as near a heating appliance.
AROUND LAMP TEMPERATURE	The temperature around the lamp is too high. It may be that the projector's ventilation holes are blocked.
LAMP1 REMAIN TIME	The lamp runtime has exceeded the prescribed cumulative time, and it is now time to replace the lamp.
LAMP2 REMAIN TIME	
LAMP1 STATUS	The lamp has failed to light.
LAMP2 STATUS	Wait a short while for the lamp to cool off, and then turn on the power.
APERTURE (CONTRAST-SHUTTER)	Trouble has occurred in the contrast shutter circuitry. Consult your dealer.
INPUT AIR TEMP. SENSOR	Trouble has occurred in the sensor used to detect the input air temperature. Consult your dealer.
OPTICS MODULE TEMP. SENSOR	Trouble has occurred in the temperature detection sensor inside the projector. Consult your dealer.
AROUND LAMP TEMP. SENSOR	Trouble has occurred in the sensor used to detect the exhaust air temperature. Consult your dealer.
BATTERY	The backup battery has been run out. Consult your dealer.
AIRFLOW SENSOR	Trouble has occurred in the sensor used to detect the airflow volume. Consult your dealer.
COVER OPEN	The lamp unit cover is not attached securely. Check the lamp unit compartment.
ACF UNIT	The air cleaning filter (ACF) is not installed or trouble has occurred. (➡ 110 page)
FILTER REMAIN	The filter remaining is getting less. (➡ 109 page)
BRIGHTNESS SENSOR	Trouble has occurred in the brightness sensor. If the problem cannot be corrected by turning the power off and on, consult your dealer.
AC POWER	AC power supply voltage input has dropped. Check that there is sufficient electrical wiring capacity for the projector's power consumption requirements.

Note

- The ACCESS ERROR INFORMATION/ACCESS INFORMATION displays the past several thousand accesses/requests. If many accesses/requests are made at a time, some of them may not be found in the information.
- Check the ACCESS ERROR INFORMATION/ACCESS INFORMATION regularly.

NETWORK menu

E-mail setup page

With this projector, if a problem occurs or if the lamp usage time reaches a set value, an e-mail message can be sent to one or more preset e-mail addresses (maximum two addresses). Click [Detailed set up], then [E-mail set up] to display the E-mail setup page.

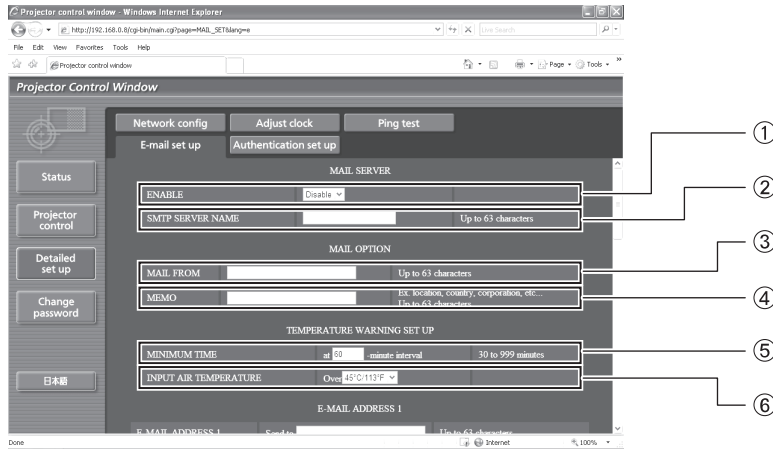

- ① Select "Enable" to use the E-mail function.
- ② Enter the IP address or server name of the E-mail server (SMTP). The DNS server must be set if the server name is entered.
- ③ Enter the E-mail address of the projector. (maximum 63 characters)
- ④ The user can enter the location of, for example, the installed projector so that the recipient may easily identify the originator of the E-mail. (maximum 63 characters)
- ⑤ The user can modify the minimum time interval of temperature warning mail. The default value is 60 minutes. In this case, the user cannot send another mail for 60 minutes after sending previous temperature warning mail even the set warning temperature is reached again.
- ⑥ Enter the E-mail address of your desired recipient.

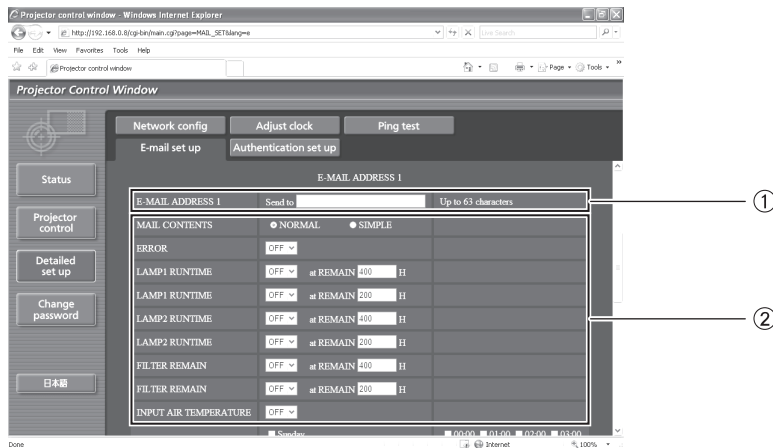

- ① Select the conditions for sending E-mail.
- ② MAIL CONTENTS: Select [NORMAL] or [SIMPLE].
 ERROR: an error is detected by self-diagnosis.
 LAMP1 RUNTIME: remaining lamp service time has reached the value set in the field.
 LAMP2 RUNTIME: remaining lamp service time has reached the value set in the field.
 FILTER REMAIN: remaining filter service time has reached the value set in the field.
 INPUT AIR TEMPERATURE: intake air temperature has reached the value set in the field.

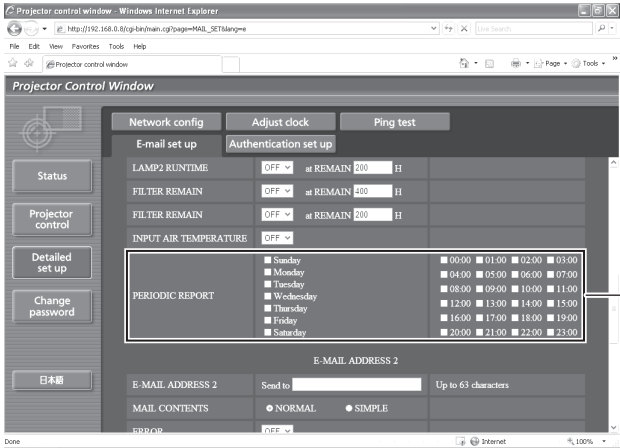

① Check these boxes when E-mail is to be sent periodically to the second E-mail address. E-mail will be sent at the times and on the days checked.

NETWORK menu

E-mail setup page (continued)

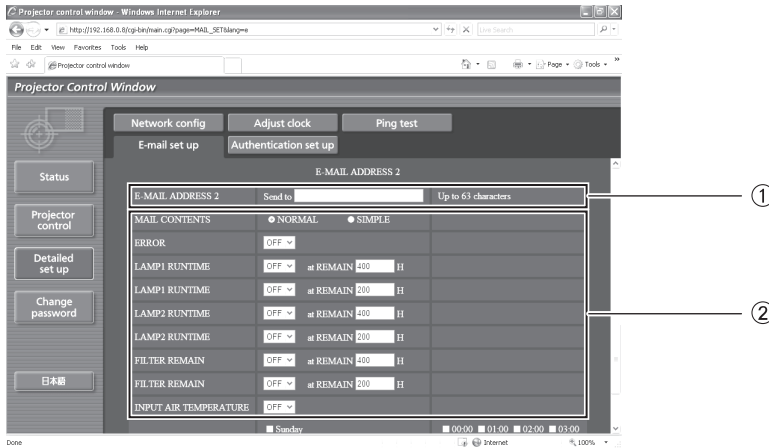

- ① Enter the E-mail address to which the E-mail is to be sent when two E-mail addresses are going to be used. Do not enter it when the second E-mail address is not going to be used.
- ② Select the conditions for sending E-mail to the second E-mail address.
 - MAIL CONTENTS: Select [NORMAL] or [SIMPLE].
 - ERROR: an error is detected by self-diagnosis.
 - LAMP1 RUNTIME: remaining lamp service time has reached the value set in the field.
 - LAMP2 RUNTIME: remaining lamp service time has reached the value set in the field.
 - FILTER REMAIN: remaining lamp service time has reached the value set in the field.
 - INPUT AIR TEMPERATURE: intake air temperature has reached the value set in the field.

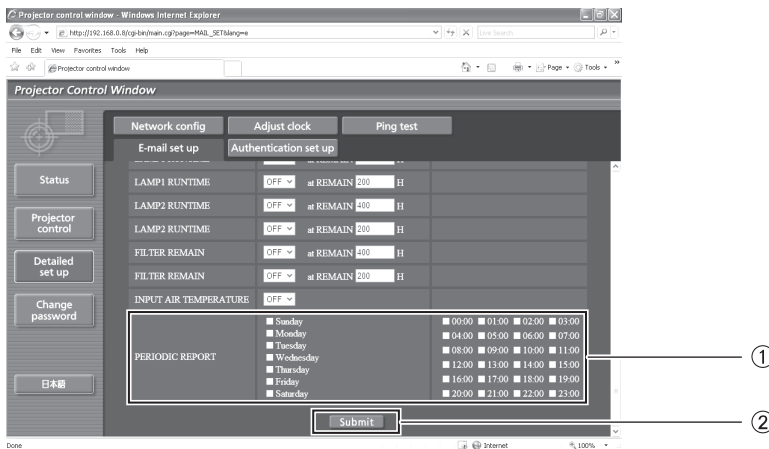

- ① Check these boxes when E-mail is to be sent periodically to the second E-mail address. E-mail will be sent at the times and on the days checked.
- ② Button to update settings

Authentication set up page

The POP/SMTP server is set on this page when POP/SMTP authentication is required for mail transmissions. Click [Detailed set up], then [Authentication set up] to display the Authentication server setup page.

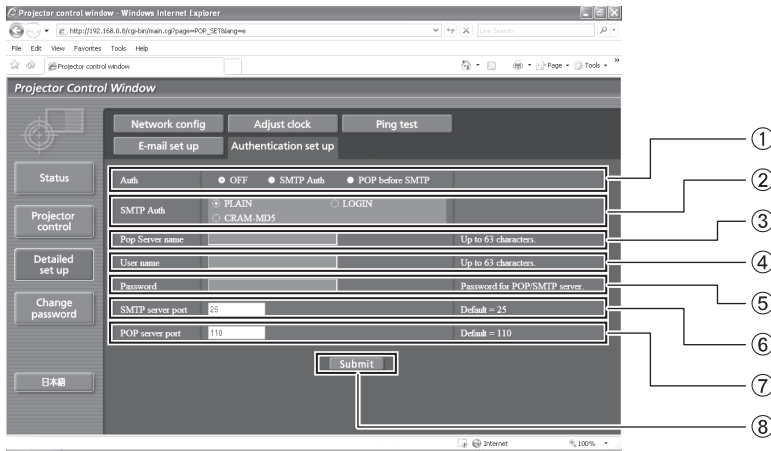

- ① Select the authentication method specified by your Internet service provider.
- ② Set this if SMTP authentication has been selected.
- ③ POP server name field
Available input characters:
Alphanumeric characters (A - Z, a - z, 0 - 9),
hyphen (-), period (.)
- ④ POP/SMTP server user name field
- ⑤ POP/SMTP server password field
- ⑥ Enter the port number for the SMTP server (normally "25").
- ⑦ Enter the port number for the POP server (normally "110").
- ⑧ Button to update settings

Ping test page

This page makes it possible to check whether the network is connected to the E-mail server, POP server, DNS server, etc.

Click [Detailed set up], then [Ping test] to display the Ping test page.

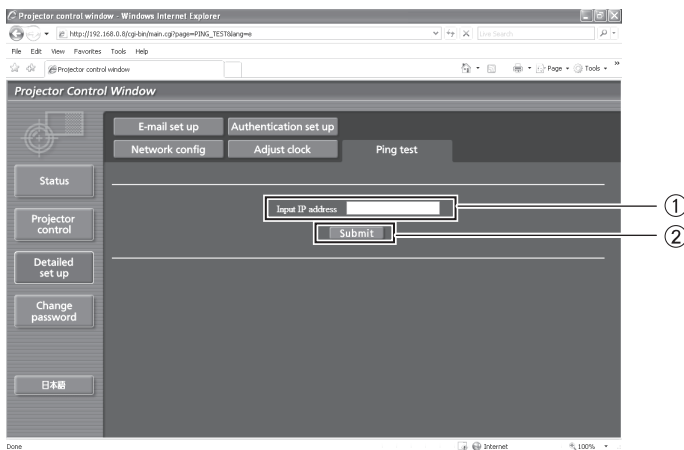

- ① Enter the IP address of the server to be tested.
- ② Button for conducting the test.

Display which appears when the connection was successful.

```
PING 198.245.80.10 (198.245.80.10): 56 data bytes
64 bytes from 198.245.80.10: icmp_seq=0 ttl=255 time=0.7 ms
64 bytes from 198.245.80.10: icmp_seq=1 ttl=255 time=0.4 ms
64 bytes from 198.245.80.10: icmp_seq=2 ttl=255 time=0.4 ms
64 bytes from 198.245.80.10: icmp_seq=3 ttl=255 time=0.4 ms
```

```
--- 198.245.80.10 ping statistics ---
4 packets transmitted, 4 packets received, 0% packet loss
round-trip min/avg/max = 0.4/0.4/0.7 ms
```

Display which appears when the connection failed.

```
PING 198.245.80.100 (198.245.80.100): 56 data bytes
--- 198.245.80.100 ping statistics ---
4 packets transmitted, 0 packets received, 100% packet loss
```

NETWORK menu

Contents of mail sent

- Mail with the contents shown below is sent when the E-mail settings have been established.

```
=== Panasonic projector report(CONFIGURE) ===
Projector Type      : DZ****
Serial No          : SW1234567

----- E-mail setup data -----
TEMPERATURE WARNING SETUP
MINIMUM TIME       at [ 60 ] minutes interval
INPUT AIR TEMPERATURE Over [ 45C / 113F ]

ERROR              [ OFF ]
LAMP1 RUNTIME      [ OFF ] at REMAIN [ 400 ] H
LAMP1 RUNTIME      [ OFF ] at REMAIN [ 200 ] H
LAMP2 RUNTIME      [ OFF ] at REMAIN [ 400 ] H
LAMP2 RUNTIME      [ OFF ] at REMAIN [ 200 ] H
FILTER REMAIN      [ OFF ] at REMAIN [ 400 ] H
FILTER REMAIN      [ OFF ] at REMAIN [ 200 ] H
INPUT AIR TEMPERATURE [ OFF ]
PERIODIC REPORT
Sunday [ OFF ] Monday [ OFF ] Tuesday [ OFF ] Wednesday [ OFF ]
Thursday [ OFF ] Friday [ OFF ] Saturday [ OFF ]

00:00 [ OFF ] 01:00 [ OFF ] 02:00 [ OFF ] 03:00 [ OFF ]
04:00 [ OFF ] 05:00 [ OFF ] 06:00 [ OFF ] 07:00 [ OFF ]
08:00 [ OFF ] 09:00 [ OFF ] 10:00 [ OFF ] 11:00 [ OFF ]
12:00 [ OFF ] 13:00 [ OFF ] 14:00 [ OFF ] 15:00 [ OFF ]
16:00 [ OFF ] 17:00 [ OFF ] 18:00 [ OFF ] 19:00 [ OFF ]
20:00 [ OFF ] 21:00 [ OFF ] 22:00 [ OFF ] 23:00 [ OFF ]

----- check system -----
MAIN CPU BUS      [ OK ]
FAN               [ OK ]
INPUT AIR TEMPERATURE [ OK ]
OPTICS MODULE TEMPERATURE [ OK ]
AROUND LAMP TEMPERATURE [ OK ]
```

- Mail with the contents shown below is sent when an error has occurred.

```
=== Panasonic projector report(ERROR) ===
Projector Type      : DZ****
Serial No          : SW1234567

----- check system -----
MAIN CPU BUS      [ OK ]
FAN               [ OK ]
INPUT AIR TEMPERATURE [ OK ]
OPTICS MODULE TEMPERATURE [ OK ]
AROUND LAMP TEMPERATURE [ OK ]
LAMP1 REMAIN TIME [ OK ]
LAMP2 REMAIN TIME [ FAILED ]
LAMP1 STATUS      [ OK ]
LAMP2 STATUS      [ OK ]
APERTURE(CONTRAST-SHUTTER) [ OK ]
INPUT AIR TEMP.SENSOR [ OK ]
OPTICS MODULE TEMP.SENSOR [ OK ]
AROUND LAMP TEMP.SENSOR [ OK ]
BATTERY           [ OK ]
AIRFLOW SENSOR    [ OK ]
COVER OPEN        [ OK ]
BRIGHTNESS SENSOR [ OK ]
ACF UNIT          [ OK ]
FILTER REMAIN     [ OK ]
AC POWER          [ OK ]
(Error code 01 00 00 00 00 00 00)

Input air temperature : 18 degC / 64 degF
Optics module temperature : 20 degC / 68 degF
Around lamp temperature : 25 degC / 77 degF
SET RUNTIME           2000 H
POWER ON              100 times
LAMP1 ON              100 times
LAMP1 LOW             0 H
LAMP1 HIGH           2000 H
LAMP1 REMAIN         0 H
LAMP2 ON              0 times
LAMP2 LOW            0 H
LAMP2 HIGH           0 H
LAMP2 REMAIN         2000 H

----- Remaining filter -----
QUANTITY             100 %
APPROX. TIME         10000 H

----- Current status -----
MAIN VERSION         1.00
NETWORK VERSION      1.00
```

Adjust clock page

Click [Detailed set up], then [Adjust clock] to display the Adjust clock page.

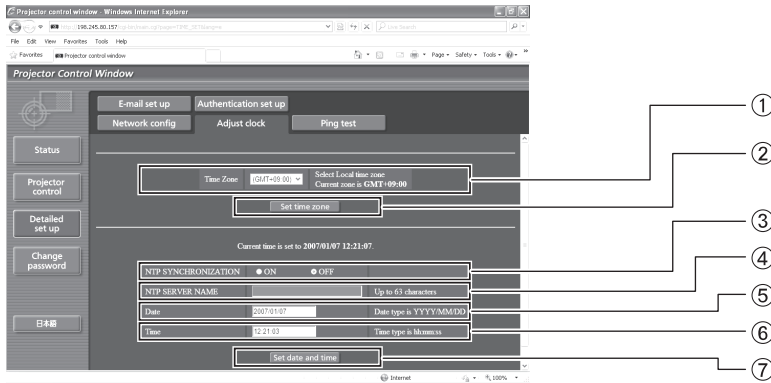

- ① Time zone selection
- ② Button to update time zone setting
- ③ Turn this [ON] to set the date and time automatically.
- ④ When setting the date and time automatically, input the IP address or name of the NTP server. (When inputting the server name, the DNS server must be set.)
- ⑤ New date field
- ⑥ New time field
- ⑦ Button to update time and date settings

Note

- If the time becomes incorrect immediately after setting the correct time, then the battery needs to be changed. Contact the dealer where you bought the projector to have the battery changed.

Network config page

Click [Detailed set up], then [Network config] to display the Network config page.

- If [Network config] is clicked, the "CAUTION!" screen is displayed.
- If the [Next] button is clicked, the current settings are displayed.
- If the [Change] button is clicked, the following setting change screen is displayed.

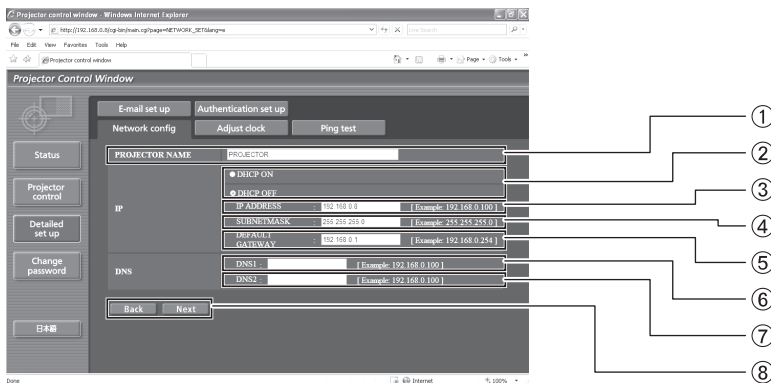

- ① Enter the name of the projector here. Enter the host name here if it is required when the DHCP server is going to be used, for instance.
- ② Set this to ON to enable the DHCP client function.
- ③ Enter the IP address if DHCP server is not used.
- ④ Enter the SUBNET MASK if DHCP server is not used.
- ⑤ Enter the gateway address if DHCP server is not used.
- ⑥ DNS server address (primary) field
Available input characters:
Numeric characters (0 - 9), period (.)
(Example: 192.168.0.253)
- ⑦ DNS server address (secondary) field
Available input characters:
Numeric characters (0 - 9), period (.)
(Example: 192.168.0.254)
- ⑧ When all options are filled, click [NEXT]. The confirmation screen will be displayed. Click [Submit] button to update.

Monitor Lamp indicators

Managing the indicated problems

If a problem should occur with the projector, the indicators will inform you. Manage the indicated problems as follow.

Attention

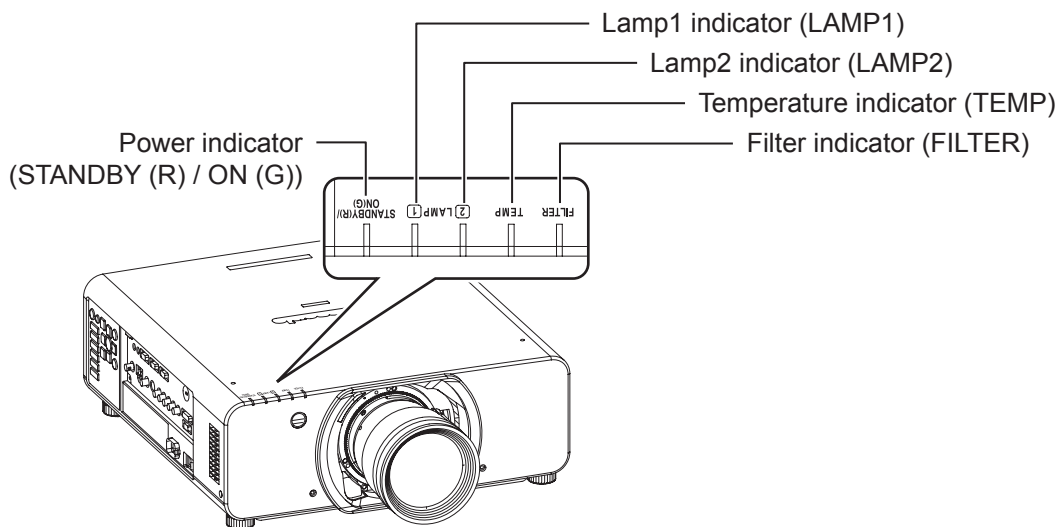

LAMP1/LAMP2 indicator

Lamp indication	Information	Check point	Remedial measure
Lighting in red	Indicates the time for replacing the lamp unit.	<ul style="list-style-type: none"> Did you notice a "REPLACE LAMP" message on the screen when turning on the projector power supply? 	<ul style="list-style-type: none"> This lamp monitor lights up when the lamp unit used hours have reached 2 800 hours (when [HIGH] is selected as the [LAMP POWER] setting). Request the dealer to replace the lamp unit.
Blinking in red (once)	Lamp unit is not installed.	<ul style="list-style-type: none"> Check the lamp unit compartment. 	<ul style="list-style-type: none"> Install the lamp unit. When lamp unit is installed and still having the indicator lights, contact to the dealer.
Blinking in red (3 times)	Error is detected in the lamp circuit.	<ul style="list-style-type: none"> Did you turn the power back on immediately after turning it off? 	<ul style="list-style-type: none"> Wait until the lamp has cooled off, and then turn on the power.
		<ul style="list-style-type: none"> Some error has arisen in the lamp circuit. Check for fluctuation (or drop) in the source voltage. 	<ul style="list-style-type: none"> Turn off the MAIN POWER switch using the procedure on page 40 and consult the dealer.

Note

- If no problem is found or the problem remains, do not turn on the projector. Instead contact your dealer.

TEMP indicator

Lamp indication	Information	Check point	Remedial measure
Lighting in red	Warm-up status	<ul style="list-style-type: none"> Did you turn on the power when the ambient temperature was lower than approx. 0 °C (32 °F)? 	<ul style="list-style-type: none"> Wait about 5 minutes in the current status. Install the unit in a location having an ambient temperature from 0 °C (32 °F) - 45 °C (113 °F).
	High temperature inside. (WARNING)		<ul style="list-style-type: none"> Remove the object that is blocking the ventilation port.
Blinking in red (once)	The filter is excessively dirty and the ventilation is poor.	<ul style="list-style-type: none"> Check the ventilation port is blocked. Is the room air temperature too high? Is the filter indicator lighted? 	<ul style="list-style-type: none"> Move the projector to a temperature of 0 °C (32 °F) - 45 °C (113 °F) and the humidity of 20 % to 80 % (no condensation).
Blinking in red (twice)	High temperature inside. (Standby condition)		<ul style="list-style-type: none"> Turn off the MAIN POWER switch using the procedure on page 40 and replace the ACF unit.
Blinking in red (3 times)	Cooling fan has been stopped.	—	<ul style="list-style-type: none"> Turn off the MAIN POWER switch using the procedure on page 40 and consult the dealer.

Note

- If no problem is found or the problem remains, do not turn on the projector. Instead contact your dealer.

FILTER indicator

Lamp indication	Information	Check point	Remedial measure
Lighting in red	The ACF unit has run out.	<ul style="list-style-type: none"> Check the [REMAINING FILTER] of [STATUS] in [PROJECTOR SETUP] menu. (➔page 84) 	<ul style="list-style-type: none"> Replace the ACF unit.
Blinking in red	The ACF unit is not installed.	<ul style="list-style-type: none"> Check the ACF unit compartment. 	<ul style="list-style-type: none"> Replace the ACF unit.
Lighting in orange	The ACF unit remains few. The remaining use time of the ACF unit is approximately 200 hours.	<ul style="list-style-type: none"> Check the [REMAINING FILTER] of [STATUS] in [PROJECTOR SETUP] menu. (➔page 84) 	<ul style="list-style-type: none"> Request the dealer to purchase the new ACF unit.
Blinking in orange	The ACF unit cannot operate properly.	<ul style="list-style-type: none"> Is foreign object blocking the ACF unit operation? 	<ul style="list-style-type: none"> Remove the foreign object from the ACF unit. When the foreign object still remained, contact the dealer.

Note

- If no problem is found or the problem remains, do not turn on the projector. Instead contact your dealer.
- When the ACF unit is not installed, the filter indicator will blink in red and the power will turn off in 10 minutes.
- When the FILTER indicator is flashing green, the Auto Cleaning Filter (ACF) is normally rolling up.
- When the ACF unit is operating, operational sound may be heard.
- The usable time after lighting of the orange lamp may be shortened in a dusty environment. The time of about 200 hours is for reference only. Contact the dealer to purchase the new ACF unit earlier.
- If the projector is used at elevations higher than 1 400 m above sea level with the [HIGH ALTITUDE MODE] at [OFF], the lamp life or life of other components will be shortened.
- Before the FILTER indicator blinks in orange when operational malfunction, mechanical sound of the clutch may be heard.
- If the Smoke Cut Filter is installed, the green lamp, which takes longer to turn ON/OFF, will flash.
- If the filter is running low, only one lamp lights even if [DUAL] is selected. The lamps will light as normal once the filter has been replaced and the residual filter has been reset.

Replacement

Before replacing the unit

- Turn off the POWER switch of the projector in proper way and disconnect the power plug from the wall outlet. (➡pages 39, 41)
- Be sure to observe the procedure “Powering off the projector” (➡page 41) when performing power supply operation.

Replacing the unit

■ ACF (Auto Cleaning Filter) unit

ACF unit is an optional accessory.

You can check the remaining amount of the ACF unit in [REMAINING FILTER] of [STATUS] in PROJECTOR SETUP menu. (➡page 84)

- Contact an Authorized Service Center to purchase a Replacement filter unit (ET-ACF310).

■ Procedure of ACF unit replacement

- 1) Loosen “ACF cover fixing screw” (1 screw) until the screws turn freely and remove the “ACF cover”.

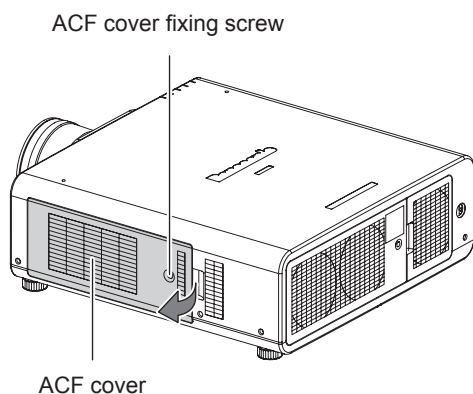

- 2) Slide out the “ACF unit” from the projector slowly.

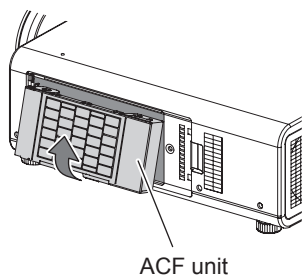

- When you replace the “ACF unit”, clean the compartment and/or the air exhaust port if you need to.

- 3) Insert the new “ACF unit” into the compartment in correct direction and slightly push until it clicks.

- 4) Attach the “ACF cover” and tighten “ACF cover fixing screw” (1 screw) securely.

- 5) Select [FILTER COUNTER RESET] in [PROJECTOR SETUP] menu, and press <ENTER> button. (➡page 86)

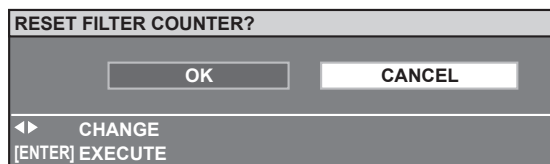

- 6) Press <> to select [OK], and press <ENTER> button.

Note

- When the ACF unit is not installed, the filter indicator will blink in red and the power will turn off in 10 minutes. (The time before the power is turned off is indicated by the unit of 1 minute.)
- The replacement timing of the ACF depends on environment of usage.
- When resetting is performed, the filter will be wound.
- The part numbers of accessories and separately sold components are subject to change without notice.
- Always install the ACF unit when using the projector.

Attention

- When installing the ACF unit, take care not to touch the filter surface.
- Be sure to install the ACF unit when using the projector.
- The ACF unit to be replaced should be an unused product.

Lamp unit

The LAMP unit is consumable product. You can check the duration of usage time using [LAMP1/LAMP2] of [STATUS] (➔page 84) in the [PROJECTOR SETUP] menu.

Replacement of the lamp unit should be carried out by a qualified technician.

Contact the dealer to purchase a replacement lamp unit (ET-LAD310:1 bulb unit, ET-LAD310W: 2 bulb units).

Precautions on lamp unit replacement

- Handle the lamp unit with special care as the lamp is made of glass. Dropping or giving it a shock may cause it to burst or damaged.
- Phillips screwdriver is necessary when replacing a lamp unit.
- When replacing the lamp unit, be sure to hold it by the handle.
- The lamp may burst. Replace the lamp unit carefully so that the broken pieces of the lamp glass will not scatter. When the projector is mounted on the ceiling, do not work directly under the projector or put your face closer to the projector.
- For disposition of used lamps, request an industrial waste disposal contractor.

Attention

- Do not attempt replacement with an unauthorized lamp unit.
- The part numbers of accessories and separately sold components are subject to change without notice.
- Wait for more than 1 hour and make sure the lamp unit and the surroundings are cooled enough.
- Prior to replacing the lamp unit, allow it to cool down to prevent the risk of burns, damage and other hazards.

When to replace the lamp unit

When the lamp is consumed, the brightness may decrease over time. 3 000 hours of use is the replacing time as a rough guide, and that might be shortened by the usage conditions, characteristics of the lamp unit or environmental conditions. Therefore, it is strongly recommended for the user to keep a spare lamp. If the lamp unit has not been replaced after 3 000 hours of operation have elapsed, the power will turn off automatically approximately 10 minutes after it is turned on.

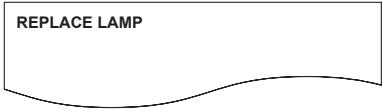
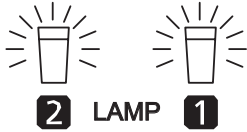
	On screen	LAMP indicator
		
Over 2 800 hours	[REPLACE LAMP] is displayed on the upper left of the screen for 30 seconds. Press any button to clear the screen, or disappears after 30 seconds.	Lights in red.
Over 3 000 hours	[REPLACE LAMP] is displayed on the upper left of the screen, and it will stay until you respond. To clear the screen, press any button.	

Note

- The guide times, 3 000 hours, are rough estimates based on certain conditions and are not a guaranteed time.

Replacement

Procedure of lamp unit replacement

Attention

- When the projector is mounted in the ceiling, do not work directly under the projector or put your face close to the projector.
- The lamp unit and the lamp unit cover must be attached correctly and securely. Failure to do so, the projector will not be turned on for the protection circuit.
- If the lamp unit is not installed smoothly, remove it and then install it again. If it is pushed in forcibly, its connector may be broken.

- 1) Turn the main power OFF, following the procedures described in “Powering off the projector” (➔ page 41), disconnect the power plug from the AC power source, and wait for one hour or more. Then check that the lamp unit has cooled down.
- 2) Turn the “lamp unit cover fixing screw” (1 piece) with a Phillips-head screwdriver until it is fully loosened, and then hold the “lamp unit cover” securely and open it in the direction of the arrow.

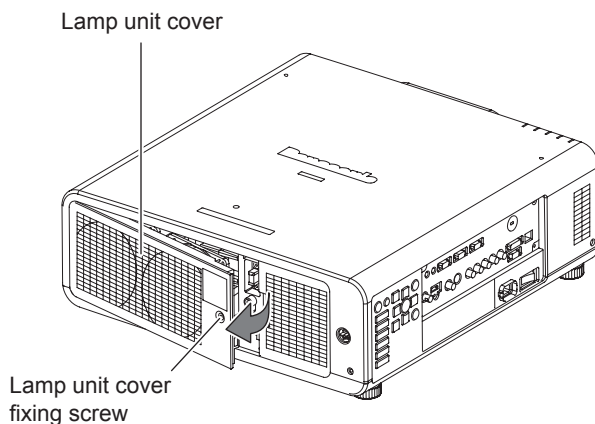

- 3) Use a Phillips screwdriver to loosen the “Lamp unit cover fixing screw” (4 screws) for the lamp unit to be replaced until the screws turn freely. Hold the “Handle” of the “Lamp unit” and gently pull the lamp unit out from the projector.

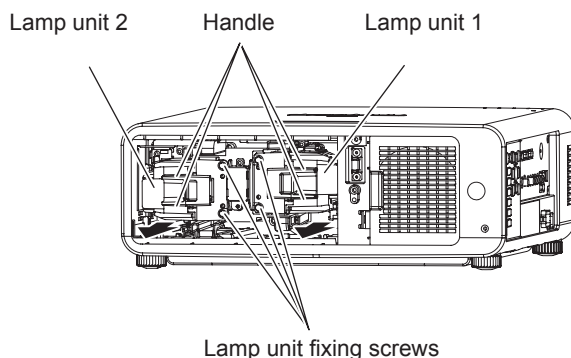

- 4) Replace the new LAMP unit in correct direction.

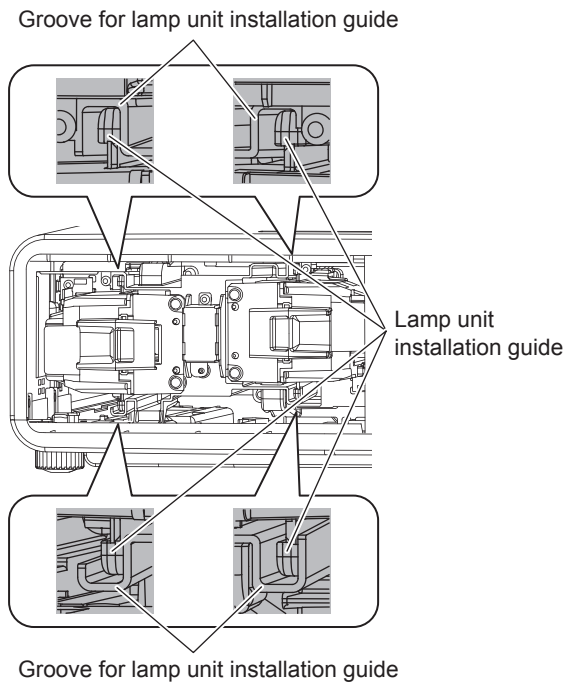

- 5) Use a Phillips screwdriver to securely tighten the 2 “Lamp unit cover fixing screw” for each lamp unit.
- 6) Close the “lamp unit cover” and tighten the “lamp unit cover fixing screw” (1 piece) securely with a Phillips-head screwdriver in the reverse order to Step 2).

Note

- When the lamp unit is replaced, the duration of usage time will be reset to “0”.

Troubleshooting

Should any problem persist, contact your dealer.

Problem	Cause	Reference page
Power does not turn on.	● The power cord may not be connected.	—
	● The <MAIN POWER> switch is turned off.	41
	● No electric supply is at the wall outlet.	—
	● The circuit breakers have tripped.	—
	● [LAMP1/LAMP2 indicator] or [TEMP indicator] is lit or flashes.	108, 109
	● The lamp unit cover has not been securely installed.	112
No picture appears.	● The video signal input source may not be connected to a terminal properly.	35
	● The input selection setting may not be correct.	47
	● The [BRIGHTNESS] adjustment setting may be at the minimum setting.	54
	● The input source which is connected to the projector may have a problem.	—
	● The [SHUTTER] function may be in use.	47
	● If the [Power indicator] flashes in red, consult your dealer.	—
The picture is fuzzy.	● The lens focus may not have been set correctly.	42
	● The projector may not be at the correct distance from the screen.	23
	● The lens may be dirty.	16
	● The projector may be tilted too much.	—
The color is pale or grayish.	● [COLOR] or [TINT] adjustment may be incorrect.	54
	● The input source which is connected to the projector may not be adjusted correctly.	—
	● RGB cable is damaged.	—
The remote control does not operate.	● The batteries may be weak.	—
	● The batteries may not have been inserted correctly.	18
	● The remote control signal receptor on the projector may be obstructed.	18
	● The remote control unit may be out of the operation range.	18
	● Strong light such as fluorescent shine onto the signal receptor.	18
	● [REMOTE CONTROLLER] of [CONTROL DEVICE SETUP] in SECURITY menu is [DISABLE].	94
	● Is the remote 2 (REMOTE2 IN) terminal used for external control?	121
	● The remote control ID setting is incorrect.	21, 76
On screen menu does not appear.	● ON SCREEN button on the remote control may have been pressed and cleared.	47
The control buttons of the projector do not operate.	● [CONTROL PANEL] of [CONTROL DEVICE SETUP] in SECURITY menu is [DISABLE].	94
	● Is the remote 2 (REMOTE2 IN) terminal used for external control?	121
The picture does not display correctly.	● [SYSTEM SELECTOR] may not have been set correctly.	58
	● There may be a problem with the VCR or other signal source.	—
	● A signal which is not compatible with the projector is being input.	123

Troubleshooting

Problem	Cause	Reference page
Picture from a computer does not appear.	<ul style="list-style-type: none"> ● The cable may be longer than the optional cable. ● The external video output from a laptop computer may not be correct. (You may be able to change the external output settings by pressing the [Fn] + [F3] or [Fn] + [F10] keys simultaneously. The actual method varies depending on the type of computer; refer to the documentation provided with your computer for further details.) 	<p style="text-align: center;">—</p> <p style="text-align: center;">—</p>
Picture from a computer DVI-D graphic board does not appear.	<ul style="list-style-type: none"> ● [DVI-D IN] setting in [DISPLAY OPTION] menu may be incorrect setting. ● The graphic board driver of the computer needs to be updated to the latest version. ● The computer may need to be restarted after switching [DVI-D IN] setting in [DISPLAY OPTION] menu of the projector correctly. 	<p style="text-align: center;">73</p> <p style="text-align: center;">—</p> <p style="text-align: center;">73</p>
Projection suddenly became darker.	<ul style="list-style-type: none"> ● Has the filter been used up? (When the filter has been used up, the projector is not shut down but is automatically switched to a [LOW] lamp output mode using one lamp.) 	<p style="text-align: center;">109</p>

Technical Information

PJLink protocol

The network function of the projector supports PJLink class 1, and the PJLink protocol can be used to perform projector setting and projector status query operations from a computer.

Control commands

The following table lists the PJLink protocol commands that can be used to control the projector.

Command	Control details	Notes
POWR	Power supply control	Parameters 0 = Standby 1 = Power ON
POWR ?	Power supply status query	Parameters 0 = Standby 1 = Power ON 2 = Cool-down in progress 3 = Warm-up in progress
INPT	Input selection	Parameters
INPT ?	Input selection query	11 = RGB1 12 = RGB2 21 = VIDEO 22 = S-VIDEO 31 = DVI-D 32 = HDMI 33 = SDI (PT-DZ110XE/PT-DS100XE only)
AVMT	Shutter control	Parameters
AVMT ?	Shutter mode query	30 = Shutter mode off (picture mute canceled) 31 = Shutter mode on (picture mute)
ERST ?	Error status query	Parameters 1st byte : Indicates fan errors, range 0 - 2 2nd byte : Indicates lamp errors, range 0 - 2 3rd byte : Indicates temperature errors, range 0 - 2 4th byte : Indicates cover open errors, range 0 - 2 5th byte : Indicates filter errors, range 0 - 2 6th byte : Indicates other errors, range 0 - 2 Definitions for each value from 0 to 2 are as follows. 0 = No error known 1 = Warning 2 = Error
LAMP ?	Lamp status query	Parameters 1st digits (1 - 5 digits) : Lamp 1 cumulative operating time 2nd digit : 0 = Lamp 1 off, 1 = Lamp 1 on 3rd digits (1 - 5 digits) : Lamp 2 cumulative operating time 4th digit : 0 = Lamp 2 off, 1 = Lamp 2 on
INST ?	Input selection list query	The following are returned as parameters. "11 12 21 22 31 32" (PT-DW90XE only) "11 12 21 22 31 32 33" (PT-DZ110XE/PT-DS100XE only)
NAME ?	Projector name query	The name set for [PROJECTOR NAME] in [NETWORK SETUP] is returned.
INF1 ?	Manufacturer name query	"Panasonic" is returned.
INF2 ?	Model name query	"DZ110", "DS100" or "DW90" is returned.
INF0 ?	Other information query	Information such as version number is returned.
CLSS ?	Class information query	"1" is returned.

PJLink security authorization

When using PJLink with security authorization, either of the password set for administrator privileges and the password set for user privileges with Web browser control can be used as the password for PJLink.

When using PJLink without security authorization, set use without the password for administrator privileges and the password for user privileges of Web browser control.

- For specifications regarding PJLink, refer to the Japan Business Machine and Information System Industries Association website.
URL <http://pjlink.jbmia.or.jp/>

Control commands via LAN

■ When WEB Control administrator rights password is set (Protect mode)

<Connection method>

1) Obtain the IP address and port number (Initial set value = 1024) of the projector and make a request for connection to the projector.

You can obtain both IP address and port number from the menu screen of the projector.

IP address : Obtain from MAIN MENU ⇒ [NETWORK] ⇒ [NETWORK STATUS]

Port No. : Obtain from MAIN MENU ⇒ [NETWORK] ⇒ [NETWORK CONTROL] ⇒ [COMMAND PORT]

2) There is a response from the projector.

Response data

Data section	Blank	Mode	Blank	Random number section	Termination symbol
"NTCONTROL" (ASCII string)	' '	'1'	' '	"zzzzzzzz" (ASCII code hexadecimal number)	(CR) 0x0d
9 bytes	1 byte	1 byte	1 byte	8 bytes	1 byte

Mode : 1 = Protect mode

3) Generate a 32-byte hash value from the following data using MD5 algorithm.

"xxxxxx:yyyyy:zzzzzzzz"

xxxxxx : Administrator rights user name for WEB CONTROL
(Default user name is "admin1")

yyyyy : Password of above administrator rights user
(Default password is "panasonic")

zzzzzzzz : 8-byte random number obtained in Step 2)

<Command transmission method>

Transmit using the following command format.

Transmitted data

Header		Data section	Termination symbol
Hash value (See above <Connection method>)	'0' 0x30	'0' 0x30	Control command (ASCII string) (CR) 0x0d
32 bytes	1 byte	1 byte	Undefined length 1 byte

Receive data

Header		Data section	Termination symbol
'0' 0x30	'0' 0x30	Control command (ASCII string)	(CR) 0x0d
1 byte	1 byte	Undefined length	1 byte

Error response

Error message	Termination symbol
"ERR1" Undefined control command	(CR) 0x0d
"ERR2" Out of parameter range	
"ERR3" Busy state or no-acceptable period	
"ERR4" Timeout or no-acceptable period	
"ERR5" Wrong data length	
"ERRA" Password mismatch	
4 bytes	1 byte

■ When WEB Control administrator rights password is not set (Non-protect mode)

<Connection method>

1) Obtain the IP address and port number (Initial set value = 1024) of the projector and make a request for connection to the projector.

You can obtain both IP address and port number from the menu screen of the projector.

IP address : Obtain from MAIN MENU ⇒ [NETWORK] ⇒ [NETWORK STATUS]

Port number : Obtain from MAIN MENU ⇒ [NETWORK] ⇒ [NETWORK CONTROL] ⇒ [COMMAND PORT]

2) There is a response from the projector.

Response data

Data section	Blank	Mode	Termination symbol
"NTCONTROL" (ASCII string) 9 bytes	' ' 0x20 1 byte	'0' 0x30 1 byte	(CR) 0x0d 1 byte

Mode : 0 = Non-protect mode

<Command transmission method>

Transmit by the following command format.

Transmitted data

Header		Data section	Termination symbol
'0' 0x30 1 byte	'0' 0x30 1 byte	Control command (ASCII string) Undefined length	(CR) 0x0d 1 byte

Receive data

Header		Data section	Termination symbol
'0' 0x30 1 byte	'0' 0x30 1 byte	Control command (ASCII string) Undefined length	(CR) 0x0d 1 byte

Error response

Error message	Termination symbol
"ERR1"	(CR)
"ERR2"	0x0d
"ERR3"	
"ERR4"	
"ERR5"	
"ERRA"	
4 bytes	1 byte

Technical Information

Serial terminal

The serial connector which is on the connector panel of the projector conforms to the RS-232C interface specification, so that the projector can be controlled by a personal computer which is connected to this connector.

■ Connection

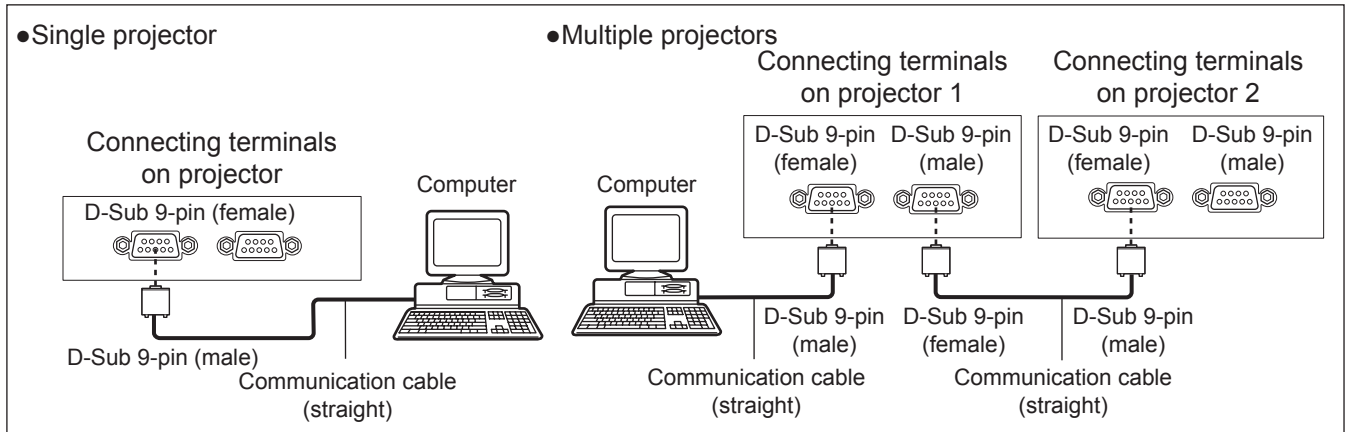

■ Pin assignments and signal names

D-Sub 9-pin (female) Outside view	Pin No.	Signal name	Contents
		①	—
②		TXD	Transmitted data
③		RXD	Received data
④		—	Connected internally
⑤		GND	Earth
⑥		—	NC
⑦		CTS	Connected internally
⑧		RTS	
⑨		—	NC

D-Sub 9-pin (male) Outside view	Pin No.	Signal name	Contents
		①	—
②		RXD	Received data
③		TXD	Transmitted data
④		—	NC
⑤		GND	Earth
⑥		—	NC
⑦		RTS	Connected internally
⑧		CTS	
⑨		—	NC

■ Communication conditions (Factory setting)

Signal level	RS-232C-compliant
Sync. method	Asynchronous
Baud rate	9 600 bps
Parity	None

Character length	8 bits
Stop bit	1 bit
X parameter	None
S parameter	None

Basic format

Transmission from the computer begins with STX, then the ID, command, parameter, and ETX are sent in this order. Add parameters according to the details of control.

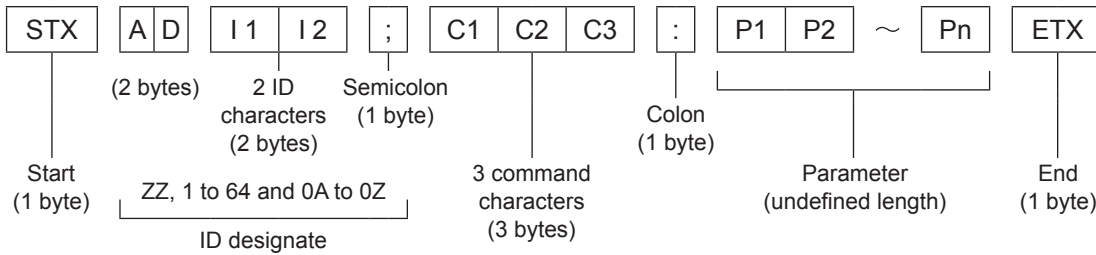

*: When sending commands without parameters, a colon (:) is not necessary.

Basic format (with sub command)

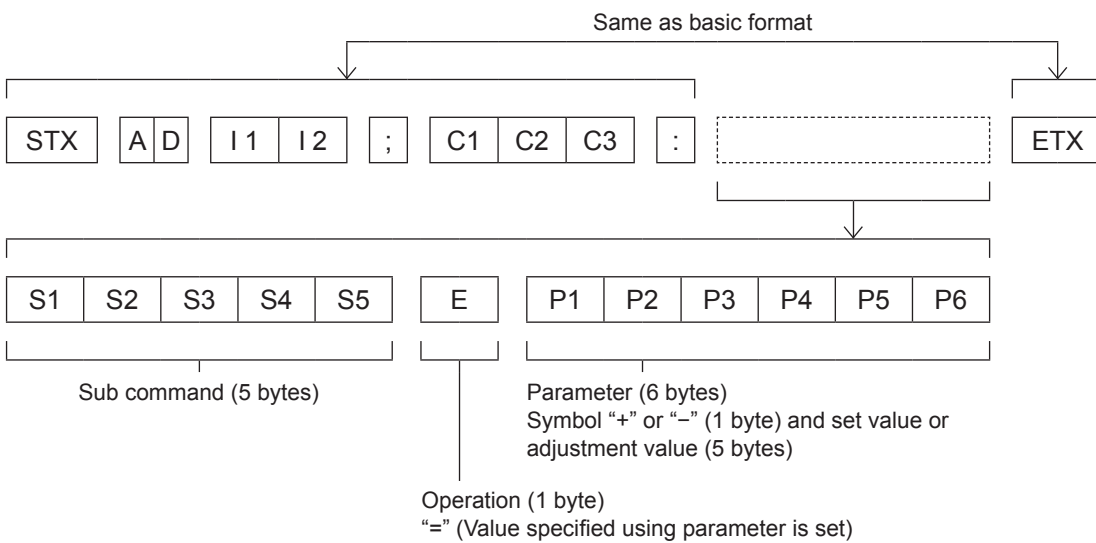

*: When transmitting a command which does not need a parameter, the operation (E) and parameter are not necessary.

Attention

- No command can be sent or received for 60 seconds after the lamp starts lighting. Try sending any command after that period has elapsed.
- When transmitting multiple commands, be sure to wait until 0.5 seconds has elapsed after receiving the response from the projector before sending the next command.

Note

- When the command can not be executed, the [ER401] status is sent from the projector to the personal computer.
- When the wrong parameter is sent, the [ER402] status is sent from the projector to the personal computer.
- Projector ID supported on the RS-232C interface is ZZ (ALL) and a group of 1 to 64 and 0A to 0Z.
- If a command is sent with a projector ID specified, the projector will return answer back only in the following cases:
If it coincides with the projector ID
If the ID specification is ALL and responding (ID ALL) is [ON]
If the ID specification is Group and responding (ID Group) is [ON]
- The "STX" character code is 02 and the "ETX" character code is 03.

Technical Information

Cable specifications

<When connected to a computer>

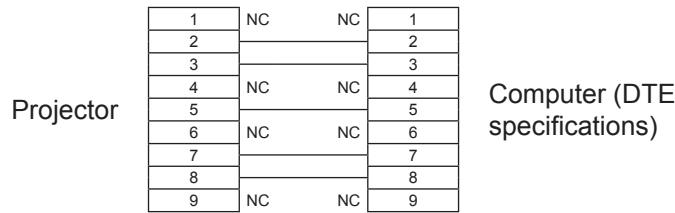

Control commands

When controlling the projector from a computer, the following commands are available:

<Projector control command>

Command	Control contents	Notes
PON	Power [ON]	To see if the power is [ON], use the [Power query] command.
POF	Power [OFF]	
QPW	Power query	000 = Standby 001 = Power [ON]
IIS	Switch input modes	VID = VIDEO SVD = S-VIDEO RG1 = RGB1 RG2 = RGB2 DVI = DVI-D SDI = SDI (PT-DZ110XE/PT-DS100XE only) HD1 = HDMI
QSL	Query for active lamp mode	0 = DUAL 1 = SINGLE 2 = LAMP1 3 = LAMP2 * [SINGLE] will use the lamp (LAMP 1 or LAMP 2) with shorter operating hours.
LPM	Active lamp mode	0 = DUAL 1 = SINGLE 2 = Only LAMP1 is on 3 = Only LAMP2 is on * [SINGLE] will use the lamp (LAMP1 or LAMP2) with shorter operating hours.
OLP	Lamp power setting	0 = HIGH 1 = LOW
QLP	Query for lamp output setting	0 = HIGH 1 = LOW
Q\$L	Query for lamp usage time	1 = LAMP1 2 = LAMP2 Response is 0000 - 3000 (Unit in hours: Number of equivalent hours for lamp output being set to [HIGH])
OSH	Shutter	0 = End 1 = Execute
QSH	Query for shutter state	0 = End 1 = Execute
VSE	Switch aspect	0 = DEFAULT/VID AUTO/VID AUTO (PRI.) 1 = 4 : 3 2 = 16 : 9 5 = THROUGH 6 = HV FIT 9 = H FIT 10 = V FIT 20 = S1 AUTO 30 = VID AUTO
QSE	Query for aspect setting	0 = DEFAULT/VID AUTO/VID AUTO (PRI.) 1 = 4 : 3 2 = 16 : 9 5 = THROUGH 6 = HV FIT 9 = H FIT 10 = V FIT 20 = S1 AUTO 30 = VID AUTO
OPP	Execute P IN P	0 = OFF 1 = USER1 2 = USER2 3 = USER3
QPP	Query for P IN P setting	0 = OFF 1 = USER1 2 = USER2 3 = USER3
QFI	Query for filter	6 = Residual (ratio), Response is 000 - 100 (Unit: %)
OCS	Switch sub memory	01 - 96 = Sub memory number
QSB	Query for sub memory state	01 - 96 = Sub memory number

<Lens control command>

Command	Sub command	Contents	Remarks
VXX	LNSI2	Lens H shift	+00000 = Fine adjustment 1+, +00001 = Fine adjustment 1-, +00100 = Fine adjustment 2+, +00101 = Fine adjustment 2-, +00200 = Rough adjustment +, +00201 = Rough adjustment -
VXX	LNSI3	Lens V shift	
VXX	LNSI4	Lens focus	
VXX	LNSI5	Lens zoom	

REMOTE 2 IN terminal

Using the [REMOTE 2 IN] terminal provided on the connection terminals of the main unit, it is possible to operate the projector from a control panel etc. furnished in a distant location where infrared remote control signal cannot be received.

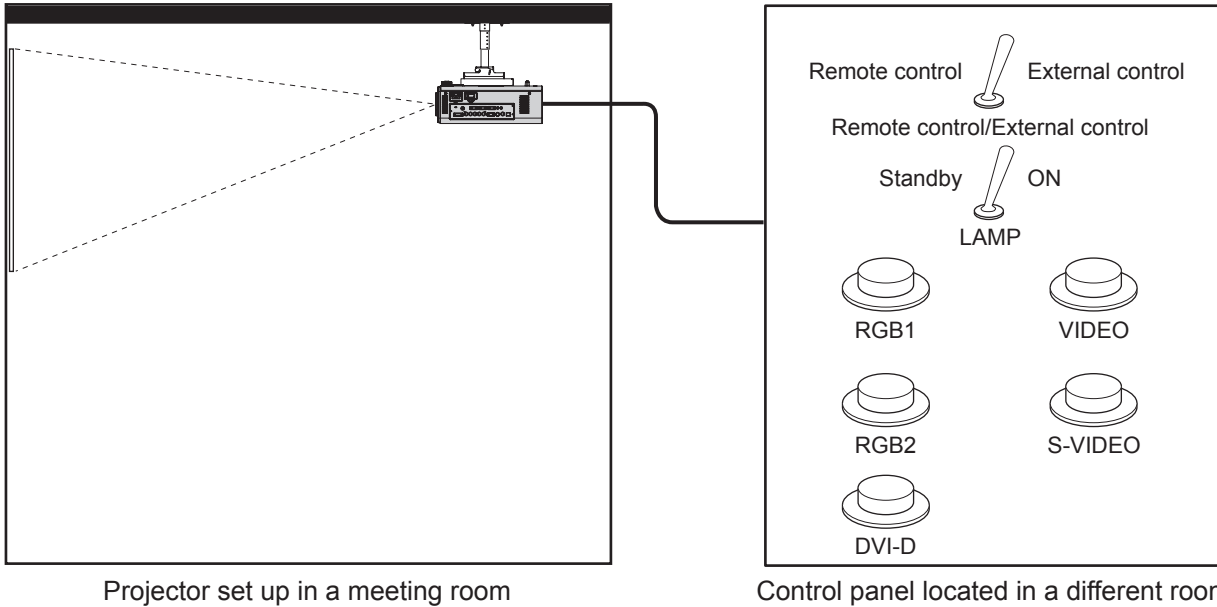

Projector set up in a meeting room

Control panel located in a different room

Pin assignments and control

D-Sub 9-pin (Outside view)	Pin No.	Signal name	Open (H)	Short (L)
	①	GND	—	GND
	②	POWER	OFF	ON
	③	RGB1	Other	RGB1
	④	RGB2	Other	RGB2
	⑤	VIDEO	Other	VIDEO
	⑥	S-VIDEO	Other	S-VIDEO
	⑦	DVI	Other	DVI
	⑧	SHUTTER	OFF	ON
	⑨	RST/SET	Controlled by remote control	Controlled by external contact

Attention

- Be sure to short-circuit Pins ① and ⑨ when controlling.
- When pin ① and pin ⑨ are short-circuited, the following buttons on the projector's control panel and on the remote control cannot be used.
 <POWER ON (I)> button, <SHUTTER> button
 In addition, the RS-232C commands and network functions that correspond to these functions cannot be used either.
- When pin ① and pin ⑨ are short-circuited and then any one of pins ③ to ⑦ is short-circuited to pin ①, the following buttons on the projector's control panel and on the remote control cannot be used.
 <POWER> button, <INPUT SELECT> buttons (RGB1, RGB2, DVI-D, SDI, VIDEO, S-VIDEO), <SHUTTER> button
 In addition, the RS-232C commands and network functions that correspond to these functions cannot be used either.
- The above is explanation in the case where "REMOTE2 MODE" of "PROJECTOR SETUP" (▶ page 85) is set to "STANDARD".

Technical Information

Two window display combination list

Subwindow Main window		RGB1		RGB2		VIDEO input	S-VIDEO input	DVI		HDMI		SDI ^{*3}
		RGB input	YP _B P _R input	RGB input	YP _B P _R input			Moving image system ^{*1}	RGB system ^{*2}	Moving image system ^{*1}	RGB system ^{*2}	
RGB1	RGB input			○	○	○	○	○	○	○	○	○
	YP _B P _R input			○	×	×	×	×	○	×	○	×
RGB2	RGB input	○	○			○	○	○	○	○	○	○
	YP _B P _R input	○	×			×	×	×	○	×	○	×
VIDEO input		○	×	○	×		×	×	○	×	×	×
S-VIDEO input		○	×	○	×	×		×	○	×	×	×
DVI	Moving image system ^{*1}	○	×	○	×	×	×			×	○	×
	RGB system ^{*2}	○	○	○	○	○	○			○	○	○
HDMI	Moving image system ^{*1}	○	×	○	×	×	×	×	○			×
	RGB system ^{*2}	○	○	○	○	×	×	○	○			×
SDI ^{*3}		○	×	○	×	×	×	×	○	×	×	

○ : P IN P (Picture in Picture) combination is possible

×

*1 : Only 480p, 576p, 720/60p, 720/50p, 1 080/60i, 1 080/50i, 1 080/24sF, 1 080/24p, 1 080/25p, 1 080/30p, 1 080/50p, and 1 080/60p are supported.

*2 : VGA (640 × 480) - WUXGA (1 920 × 1 200)

non-interlace signal, Dot clock frequency : 25 MHz - 162 MHz

(The WUXGA signals support only VESA CVT-RB (Reduced Blanking) signals.)

*3 : PT-DZ110XE/PT-DS100XE only

Note

- If the horizontal resolution of the input signal of the sub window is 1 280 pixels or above, the picture quality of the sub window may be lowered.

Restoring the MENU LOCK PASSWORD to default

- ① Press <AUTO SETUP> button for more than 2 seconds.
- ② Press ▼ for more than 2 seconds.

List of compatible signals

The following table specifies the types of signals compatible with the projector.

Format : V = VIDEO, S = S-VIDEO, D = DVI, H : HDMI, R : RGB, Y : YP_BP_R, SDI *

Mode	Display resolution (dots)	Scanning frequency		Dot clock frequency (MHz)	Format	PnP *1				
		H (kHz)	V (Hz)			RGB2	DVI-D EDID1	DVI-D EDID2	DVI-D EDID3	HDMI
NTSC/NTSC4.43/ PAL-M/PAL60	720 × 480i	15.7	59.9	—	V/S					
PAL/PAL-N/SECAM	720 × 576i	15.6	50.0	—	V/S					
525i (480i)	720 × 480i	15.7	59.9	13.5	R/Y/SDI					
625i (576i)	720 × 576i	15.6	50.0	13.5	R/Y/SDI					
525p (480p)	720 × 483	31.5	59.9	27.0	D/H/R/Y		○		○	○
625p (576p)	720 × 576	31.3	50.0	27.0	D/H/R/Y		○		○	○
1 125 (1 080)/60i *2	1 920 × 1 080i	33.8	60.0	74.3	D/H/R/Y/SDI		○		○	○
1 125 (1 080)/50i	1 920 × 1 080i	28.1	50.0	74.3	D/H/R/Y/SDI		○		○	○
1 125 (1 080)/24p	1 920 × 1 080	27.0	24.0	74.3	D/H/R/Y/SDI		○		○	○
1 125 (1 080)/24sF	1 920 × 1 080i	27.0	24.0	74.3	D/H/R/Y/SDI					
1 125 (1 080)/25p	1 920 × 1 080	28.1	25.0	74.3	D/H/R/Y/SDI		○		○	
1 125 (1 080)/30p	1 920 × 1 080	33.8	30.0	74.3	D/H/R/Y/SDI					
1 125 (1 080)/60p	1 920 × 1 080	67.5	60.0	148.5	D/H/R/Y		○		○	○
1 125 (1 080)/50p	1 920 × 1 080	56.3	50.0	148.5	D/H/R/Y		○		○	○
750 (720)/60p	1 280 × 720	45.0	60.0	74.3	D/H/R/Y/SDI		○		○	○
750 (720)/50p	1 280 × 720	37.5	50.0	74.3	D/H/R/Y/SDI		○		○	○
VESA400	640 × 400	31.5	70.1	25.2	D/H/R					
	640 × 400	37.9	85.1	31.5	D/H/R					
VGA480	640 × 480	31.5	59.9	25.2	D/H/R	○	○	○	○	○
	640 × 480	35.0	66.7	30.2	D/H/R					
	640 × 480	37.9	72.8	31.5	D/H/R	○		○	○	○
	640 × 480	37.5	75.0	31.5	D/H/R	○		○	○	○
	640 × 480	43.3	85.0	36.0	D/H/R					
SVGA	800 × 600	35.2	56.3	36.0	D/H/R	○		○	○	○
	800 × 600	37.9	60.3	40.0	D/H/R	○		○	○	○
	800 × 600	48.1	72.2	50.0	D/H/R	○		○	○	○
	800 × 600	46.9	75.0	49.5	D/H/R	○		○	○	○
	800 × 600	53.7	85.1	56.3	D/H/R					
MAC16	832 × 624	49.7	74.6	57.3	D/H/R	○		○	○	○
XGA	1 024 × 768	39.6	50.0	51.9	D/H/R					
	1 024 × 768	48.4	60.0	65.0	D/H/R	○		○	○	○
	1 024 × 768	56.5	70.1	75.0	D/H/R	○		○	○	○
	1 024 × 768	60.0	75.0	78.8	D/H/R	○		○	○	○
	1 024 × 768	65.5	81.6	86.0	D/H/R					
	1 024 × 768	68.7	85.0	94.5	D/H/R					
	1 024 × 768	80.0	100.0	105.0	D/H/R					
	1 024 × 768	96.7	120.0	130.0	D/H/R					
MXGA	1 152 × 864	53.7	60.0	81.6	D/H/R					
	1 152 × 864	64.0	71.2	94.2	D/H/R					
	1 152 × 864	67.5	74.9	108.0	D/H/R					
	1 152 × 864	76.7	85.0	121.5	D/H/R					
MAC21	1 152 × 870	68.7	75.1	100.0	D/H/R	○		○	○	○
1 280 × 720	1 280 × 720	37.1	49.8	60.5	D/H/R					
	1 280 × 720	44.8	59.9	74.5	D/H/R					
1 280 × 768	1 280 × 768	39.6	49.9	65.3	D/H/R					
	1 280 × 768	47.8	59.9	79.5	D/H/R					
	1 280 × 768 *3	47.4	60.0	68.3	D/H/R					
	1 280 × 768	60.3	74.9	102.3	D/H/R					
	1 280 × 768	68.6	84.8	117.5	D/H/R					

*: PT-DZ110XE/PT-DS100XE only

Technical Information

Mode	Display resolution (dots)	Scanning frequency		Dot clock frequency (MHz)	Format	PnP *1				
		H (kHz)	V (Hz)			RGB2	DVI-D EDID1	DVI-D EDID2	DVI-D EDID3	HDMI
1 280 × 800	1 280 × 800	41.3	50.0	68.0	D/H/R					
	1 280 × 800	49.7	59.8	83.5	D/H/R					
	1 280 × 800 *3	49.3	59.9	71.0	D/H/R					
	1 280 × 800	62.8	74.9	106.5	D/H/R					
	1 280 × 800	71.6	84.9	122.5	D/H/R					
MSXGA	1 280 × 960	60.0	60.0	108.0	D/H/R					
SXGA	1 280 × 1 024	52.4	50.0	88.0	D/H/R					
	1 280 × 1 024	64.0	60.0	108.0	D/H/R	○		○	○	○
	1 280 × 1 024	72.3	66.3	125.0	D/H/R					
	1 280 × 1 024	78.2	72.0	135.1	D/H/R					
	1 280 × 1 024	80.0	75.0	135.0	D/H/R	○		○	○	○
1 366 × 768	1 366 × 768	47.7	59.8	84.8	D/H/R	○ *4		○ *4	○ *4	○ *4
	1 366 × 768	39.6	49.9	69.0	D/H/R					
SXGA+	1 400 × 1 050	54.1	50.0	99.9	D/H/R					
	1 400 × 1 050	64.0	60.0	108.0	D/H/R					
	1 400 × 1 050	65.2	60.0	122.6	D/H/R	○		○	○	○
	1 400 × 1 050	65.3	60.0	121.8	D/H/R					
	1 400 × 1 050	78.8	72.0	149.3	D/H/R					
WXGA+	1 440 × 900	55.9	59.9	106.5	D/H/R					
	1 440 × 900	46.3	49.9	86.8	D/H/R					
UXGA60	1 600 × 1 200	75.0	60.0	162.0	D/H/R	○		○	○	○
WSXGA+	1 680 × 1 050	65.3	60.0	146.3	D/H/R					
	1 680 × 1 050	54.1	50.0	119.5	D/H/R					
1 920 × 1 080	1 920 × 1 080	55.6	49.9	141.5	D/H/R					
	1 920 × 1 080 *3	66.6	59.9	138.5	D/H/R					
	1 920 × 1 080 *6	67.2	60.0	173.0	R					
WUXGA	1 920 × 1 200	61.8	49.9	158.3	D/H/R					
	1 920 × 1 200 *3	74.0	60.0	154.0	D/H/R	○		○	○ *5	○ *5
	1 920 × 1 200 *6	74.6	59.9	193.3	R					

*1 : Where marked “○” signals indicates in Plug and Play is compatible with EDID of projector. Unmarked signals in Plug and Play may also be compliant if input terminals are written in the format list. Where Plug and Play is unmarked and nothing is written in the format list, difficulties in projecting image may occur even when computer and projector appear to have same resolution.

*2 : If a signal of 1 125 (1 035)/60i is input, it will be displayed as a signal of 1 125 (1 080)/60i.

*3 : VESA CVT-RB (Reduced Blanking) compatible.

*4 : PT-DW90XE only

*5 : PT-DZ110XE only

*6 : Some loss of data occurs to make projection easier.

Note

- The number of display dots of the PT-DZ110XE is 1 920 × 1 200, and the number of display dots of the PT-DS100XE is 1 400 × 1 050.

A signal of a different resolution than the above data is converted to the number of display dots and then displayed.

- The “i” appearing after the resolution indicates an interlaced signal.
- Flicker (line flicker) may be caused in images if interlace is connected.

Specifications

Model No.		PT-DZ110XE	PT-DS100XE	PT-DW90XE
Power supply		AC220 V-240V 50 Hz/60 Hz		
Power consumption		920 W	900 W	
		When [STANDBY MODE] is [ECO] : Approx. 0.3 W When [STANDBY MODE] is [NORMAL] : Approx. 8 W		
Amps		5.0 A	4.8 A	
DLP chip	Panel size	0.96 inch (aspect ratio 16 : 10)	0.95 inch (aspect ratio 4 : 3)	0.85 inch (aspect ratio 16 : 9)
	Display system	Three-unit DLP chip, DLP type		
	Number of pixels	2 304 000 pixels (1 920 × 1 200 dots) × 3	1 470 000 pixels (1 400 × 1 050 dots) × 3	1 049 088 pixels (1 366 × 768 dots) × 3
Lens		Option		
Projection lamp		2 bulbs × 355 W UHM lamp		
Optical output *1		10 600 lm (ANSI)		9 600 lm (ANSI)
Applicable scanning frequency *2	For RGB signal	H : 15 kHz - 100 kHz, V : 24 Hz - 120 Hz PIAS (Panasonic Intelligent Auto Scanning) system		
		Dot clock frequency Less than 162 MHz		
	For YP _B P _R signal	[480i] H: 15.73 kHz, V: 59.94 Hz [480p] H: 31.5 kHz, V: 59.94 Hz [720/50p] H: 37.5 kHz, V: 50 Hz [1 035/60i] H: 33.75 kHz, V: 60 Hz [1 080/60i] H: 33.75 kHz, V: 60 Hz [1 080/25p] H: 28.13 kHz, V: 25 Hz [1 080/30p] H: 33.75 kHz, V: 30 Hz [1 080/50p] H: 56.25 kHz, V: 50 Hz	[576i] H: 15.63 kHz, V: 50 Hz [576p] H: 31.25 kHz, V: 50 Hz [720/60p] H: 45 kHz, V: 60 Hz [1 080/50i] H: 28.13 kHz, V: 50 Hz [1 080/24p] H: 27 kHz, V: 24 Hz [1 080/24sF] H: 27 kHz, V: 48 Hz [1 080/60p] H: 67.5 kHz, V: 60 Hz	
	For video signal (S-video included)	H : 15.75 kHz/15.63 kHz, V : 50 Hz/60 Hz		
	For DVI-D/HDMI signal	480p, 576p, 720/60p, 720/50p, 1 080/60p, 1 080/50p, 1 080/60i, 1 080/50i, 1 080/24sF, 1 080/30p, 1 080/25p, 1 080/24p ● Displayable resolution : VGA - WUXGA (non-interlace) ● Dot clock frequency : 25 MHz - 162 MHz		
For SDI signal	SMPTE259M compatible: [480i], [576i] SMPTE292M compatible: [720/60p], [720/50p], [1 035/60i], [1 080/60i], [1 080/50i], [1 080/25p], [1 080/24p], [1 080/24sF], [1 080/30p]		—	
Color system		7 standards (NTSC/NTSC4.43/PAL/PAL-N/PAL-M/SECAM/PAL60)		
Screen size		70 inch - 600 inch *3		
Screen aspect ratio		16 : 10	4 : 3	16 : 9
Projection scheme		Menu-selectable from front/rear/ceiling mount, and floor mounting		
Contrast ratio		10 000 : 1 (when [DYNAMIC IRIS] has been set to [3])		
Terminals	RGB1 IN	1 set, BNC × 5 [RGB signal] 0.7 V [p-p] 75 Ω (G-SYNC : 1.0 [p-p] 75 Ω) HD/SYNC TTL high impedance, automatic positive/negative polarity compatible VD TTL high impedance, automatic positive/negative polarity compatible [YP _B P _R signal] Y : 1.0 V [p-p] Synchronization signal included, P _B P _R : 0.7 V [p-p] 75 Ω		
	RGB2 IN	1 set of high density, D-sub 15-pin (female) [RGB signal] 0.7 V [p-p] 75 Ω (G-SYNC : 1.0 [p-p] 75 Ω) HD/SYNC TTL high impedance, automatic positive/negative polarity compatible VD TTL high impedance, automatic positive/negative polarity compatible [YP _B P _R signal] Y : 1.0 V [p-p] Synchronization signal included, P _B P _R : 0.7 V [p-p] 75 Ω		

Specifications

Model No.		PT-DZ110XE	PT-DS100XE	PT-DW90XE
Terminals	VIDEO IN	1 set, BNC, 1.0 V [p-p] 75 Ω		
	S-VIDEO IN	1 set, Mini DIN 4-pin, Y: 1.0 V [p-p], C: 0.286 V [p-p] 75 Ω, compatible with S1 signal		
	DVI-D IN	1 set, DVI-D 24-pin (Single link), DVI 1.0 compatible, HDCP compatible		
	HDMI IN	1 set, HDMI 19-pin (HDCP/Deep color compatible)		
	SDI IN	1 set, BNC, Y/CB/CR/4 : 2 : 2, 10 bits SMPTE259M/SMPTE292M compatible	—	
	SERIAL IN/OUT	1 set, D-sub 9-pin, RS-232C compatible, computer control use		
	REMOTE 1 IN/OUT	1 set, M3 pin jack, wired remote control use, multiple connection use		
	REMOTE 2 IN	1 set, D-sub 9-pin, external control use		
	LAN	1 set, RJ-45, network connection use, PLink compatible, 10 Base-T/100Base-TX		
Power cord length		3.0 m		
Cabinet		Moulded plastic		
Dimensions		Width : 530 mm (20 7/8"), Length : 200 mm (7 7/8"), Height : 548.5 mm (21 19/32") (540 mm (21 1/4") : not including surface projection parts)		
Weight		Approx. 24.0 kg (52.9 lbs.) *4		
Operating environment		Temperature *5 : 0 °C to 45 °C Humidity : 10 % to 80 % (no condensation)		
Remote control	Power supply	DC 3 V (AA/R6 battery × 2)		
	Operating range	Approx. 30 m (98'5") (when operated directly in front of signal receptor)		
	Weight	134 g (4.7 ozs.) (including batteries)		
	Dimensions	Width : 51 mm (2"), Length : 176 mm (6 15/16"), Height : 28 mm (1 3/32")		
Options	Ceiling bracket	For high ceiling : ET-PKD310H For low ceiling : ET-PKD310S Ceiling Mount Attachment : ET-PAD310		
	Projection lens	ET-D75LE6, ET-D75LE1, ET-D75LE2, ET-D75LE3, ET-D75LE4 ET-D75LE5, ET-D75LE8 ET-D75LE10, ET-D75LE20, ET-D75LE30		
	Lens Motor Cover	ET-D75MC1		
	Replacement Lamp Unit	ET-LAD310 (1 bulb), ET-LAD310W (2 bulbs)		
	Replacement filter unit	ET-ACF310		
	Smoke Cut Filter	ET-SFD310		
	Frame	ET-PFD310		

- *1 : Measurement, measuring conditions and method of notation all comply with ISO21118 international standards.
- *2 : For details of video signals that can be projected using this projector, refer to "List of compatible signals" (➔page 123).
- *3 : If ET-D75LE5 is installed, screen size is 70 inches - 300 inches.
- *4 : This is the average value. It may differ depending on each product.
- *5 : When using this projector at high elevations 1 400 - 2 700 m (4 593 - 8 858 ft) sea level, temperature will be 5 °C lower than this higher limit.
When a Smoke Cut Filter is used, the ambient temperature is 0 °C to 35 °C. However, use at high altitudes is not possible.

- The part numbers of accessories and separately sold components are subject to change without notice.

Specifications

Dimensions

<Unit : mm>

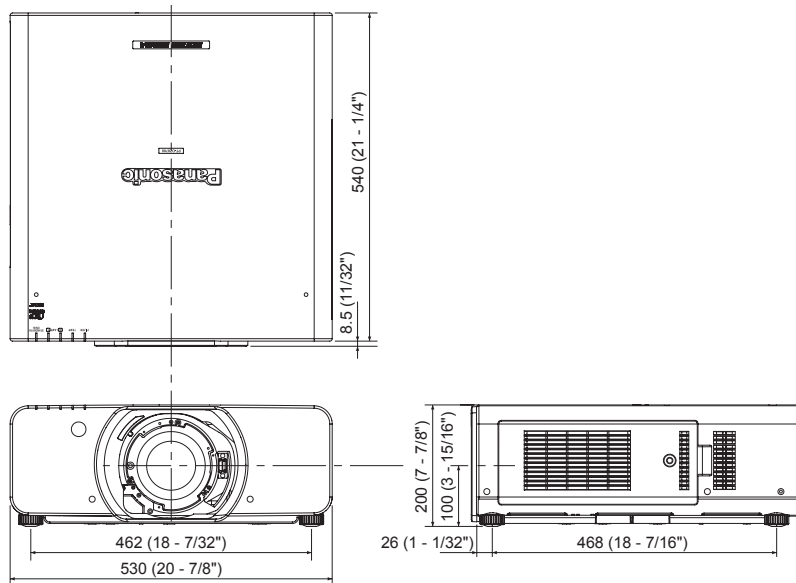

About brand

Trademark Acknowledgement

- Microsoft® and its logos, Windows®, Windows® XP, Windows Vista®, Windows® 7, and Internet Explorer® are the registered trademarks or trademarks of Microsoft Corporation in the United States and/or other countries.
- Macintosh, Mac OS and Safari are the trademarks of Apple Inc. registered in the United States and other countries.
- PJLink™ is a pending trademark in Japan, the United States, and other countries and regions.
- HDMI, the HDMI logo and High-Definition Multimedia Interface are the trademarks or registered trademarks of HDMI Licensing LLC.
- Other types of names such as company names and product names appearing in this instruction manual are trademarks or registered trademarks of their respective holders.
The ® and TM marks are not indicated in this instruction manual.

Ceiling mount bracket safeguards

When installing the ceiling mount bracket to the projector, install the accessory Drop-prevention bracket (Safety cables) to the projector.

(The projector will still be safe if they are not used, however they will help prevent the possibility of accidents caused by the projector falling down if the screws happen to become loose.)

Ceiling bracket : For high ceiling : ET-PKD310H, For low ceiling : ET-PKD310S,
Ceiling Mount Attachment : ET-PAD310

Installation work of the ceiling mount bracket should only be carried by a qualified technician according to the following procedure.

- Panasonic takes no responsibility for any losses or damage occurring as a result of using a ceiling mount bracket not manufactured by Panasonic, or if damage to the projector occurs as a result of an inappropriate location used for installing the ceiling mount bracket, even if the projector's warranty period has not yet expired.
- Use a torque screwdriver or similar tool to tighten the screws. Do not use tools such as electric screwdrivers or impact screwdrivers.
- An unused ceiling mount bracket should be removed promptly by qualified technician.
- Do not use the screw holes of the front leg adjusters for the projector installation.
- Do not attach the safety cable to the burglar hook port and suspend the projector on it.
- For how to install wire ropes to the ceiling, see the installation manual for the ceiling mount bracket.
- For details, see the installation manual for the ceiling mount bracket.
- The part numbers of accessories and separately sold components are subject to change without notice.

Attachment procedure

- 1) Turn the projector upside down and place it gently on a soft cloth.
- 2) Put the plain washer on the wire rope fixing screw.
- 3) Put the wire rope through the wire rope fixing screw.
- 4) Install the wire rope fixing screws to the projector and tighten them.
 - Install the wire ropes to the 2 places in a similar manner.

Wire rope fixing screw: M6 x L20.
Tightening torque of fixing screw: 4 ± 0.5 Nm

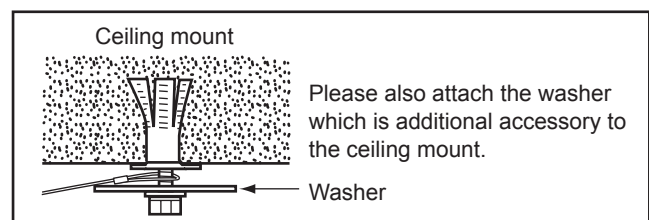
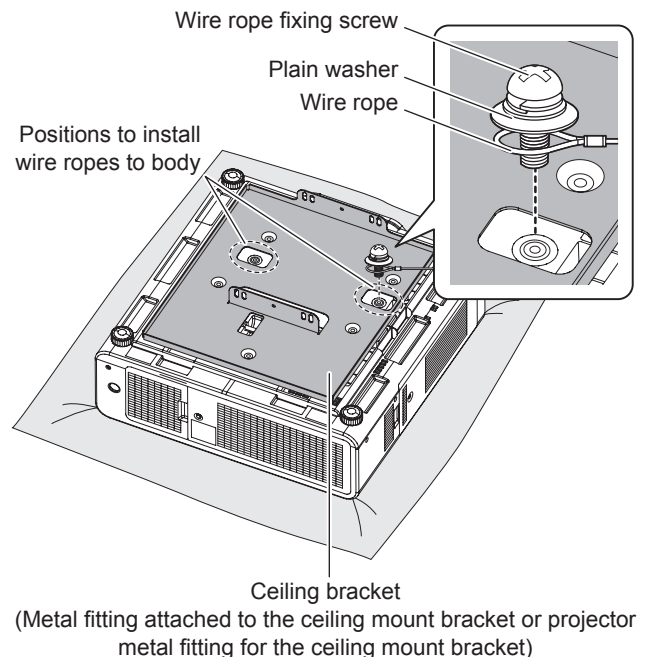

Attention

- Do not use other than the provided Wire rope fixing screw (x2), washers (x4) and Safety cables (x2).
- Install the wire ropes so that they do not sag between the installation portions on the body and those on the ceiling.

Index

A			
About brand	127		
Accessories	17		
ADVANCED MENU	64		
ASPECT	59		
AUTO SETUP	72		
AUTO SETUP function	48		
AUTO SIGNAL	72		
B			
BACK COLOR	75		
BLANKING	64		
BRIGHTNESS	54		
BRIGHTNESS CONTROL	78		
C			
Ceiling mount bracket	128		
CLAMP POSITION	65		
CLOCK PHASE	61		
COLOR	54		
COLOR MATCHING	69		
COLOR TEMPERATURE	55		
Connecting			
AV equipment	36		
Before connection to the projector	35		
Computers	37		
Connecting the power cord	39		
CONTRAST	54		
Control commands via LAN	116		
CONTROL DEVICE SETUP	94		
COOLING CONDITION	77		
D			
DATE AND TIME	85		
DIGITAL CINEMA REALITY	64		
Dimensions	127		
Direct power off function	41		
Display language	68		
DISPLAY LANGUAGE menu	68		
DISPLAY OPTION menu	69		
DISPLAY SETTING	93		
DVI-D IN	73		
DYNAMIC IRIS	57		
E			
EDGE BLENDING	65		
F			
FILTER COUNTER RESET	86		
FILTER indicator	109		
FOCUS			
Adjusting	42		
FRAME DELAY	67		
FREEZE	75		
Front leg adjusters	34		
FUNCTION	48, 85		
G			
GAMMA	56		
GEOMETRY	61		
H			
HDMI IN	74		
HIGH ALTITUDE MODE	76		
I			
Important Safety Notice	2		
INITIALIZE	87		
INPUT RESOLUTION	65		
Input signal	47		
INSTALLATION	76		
Internal test pattern	48		
K			
KEystone	63		
L			
LAMP indicator	108		
LAMP POWER	78		
LAMP RELAY	77		
LAMP SELECT	77		
LARGE SCREEN CORRECTION	70		
LENS CALIBRATION	86		
Lens position	43		
List of compatible signals	123		
LOAD ALL USER DATA	87		
M			
MAIN MENU	51		
Managing the indicated problems	108		
MENU LOCK	93		
MENU LOCK PASSWORD	122		
Menu Navigation	50		
N			
Navigating through the menu	50		
NETWORK menu	95		
NOISE REDUCTION	57		
NO SIGNAL SHUT-OFF	85		
O			
On-screen display	47, 74		
P			
Picture Aspect ratio	49		
PICTURE menu	53		
PICTURE MODE	53		
P IN P function	88		
P IN P menu	88		
PJLink protocol	115		
POSITION menu	59		
Powering off the projector	41		
Powering up the projector	40		
Precautions with regard to safety	9		
Projecting	42		
Projection lens	38		
Projection method	22		
Projector body	19		
PROJECTOR ID	76		
PROJECTOR SETUP menu	76		
R			
RASTER POSITION	67		
REMOTE 2 IN terminal	121		
REMOTE2 MODE	85		
Remote control	18		
Replacement	110		
RGB IN	73		
RS-232C	83		
S			
SAVE ALL USER DATA	87		
SCHEDULE	82		
SCREEN SETTING	70		
Screen size and throw distance	23		
SDI IN	74		
SECURITY menu	92		
SECURITY PASSWORD	92		
Selecting the input signal	42		
Serial terminal	118		
SERVICE PASSWORD	87		
Setting projector ID number to remote control	21		
Setting up	22		
SHARPNESS	57		
SHIFT	59		
SHUTTER function	47		
SIGNAL LIST	90		
Registering a signal	90		
SIGNAL LIST menu	90		
Specifications	125		
STANDBY MODE	82		
STARTUP LOGO	75		
STATUS	84		
STATUS function	47		
Sub memory	91		
SUB MENU	51		
SYSTEM DAYLIGHT VIEW	56		
SYSTEM SELECTOR	58		
T			
Technical Information	115		
TEMP indicator	109		
TEST PATTERN	89		
TEST PATTERN menu	89		
TINT	54		
Troubleshooting	113		
Two window display combination	122		
W			
WAVEFORM MONITOR	71		
Wired remote control	21		
Z			
ZOOM	60		

EEE Yönetmeliğine Uygundur.
EEE Complies with Directive of Turkey.



Panasonic Corporation

Web Site : <http://panasonic.net/avc/projector/>
© Panasonic Corporation 2010

F0710-10710
TQBJ0342