

# HITACHI

Liquid Crystal Projector

## CPS317/CPX327/EDS3170/EDX3270

(CPS317W/CPX327W/EDS3170/EDX3270)

### USER'S MANUAL Vol.1 Basic

Please read this user's manual thoroughly to ensure correct usage through understanding.

### BEDIENUNGSANLEITUNG Teil 1 Grundlagen

Bitte lesen Sie diese Benutzerhandbuch zugunsten der korrekten Bedienung aufmerksam.

### MANUEL D'UTILISATION Vol.1 Fondements

Nous vous recommandons de lire attentivement ce manuel pour bien assimiler le fonctionnement de l'appareil.

### MANUALE D'ISTRUZIONI Vol.1 Informazioni di base

Vi preghiamo voler leggere attentamente il manuale d'istruzioni in modo tale da poter comprendere quanto riportato ai fini di un corretto utilizzo del proiettore.

### MANUAL DE USUARIO Vol.1 Básico

Lea cuidadosamente este manual del usuario para poder utilizar correctamente el producto.

### GEbruIKSAANWIJZING Vol.1 Basis

Lees voor het gebruik alstublieft deze handleiding aandachtig door, om volledig profijt te hebben van de uitgebreide mogelijkheden.

### BRUKERHÅNDBOK Vol.1 Grunnleggende

Vennligst les denne bruksanvisningen grundig for å være garantert driftssikker bruk.

### INSTRUÇÕES DO PROPRIETÁRIO Vol.1 Básico

Para assegurar o uso correto do equipamento, por favor leia atentamente este manual do utilizador.

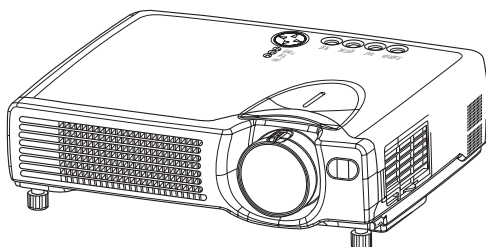

ENGLISH

DEUTSCH

FRANÇAIS

ITALIANO

ESPAÑOL

NEDERLANDS

NORSK

PORTGÊS

# USER'S MANUAL Vol.1 (Basic)

Thank you for purchasing this projector.

**WARNING** • Please read the accompanying manual “SAFETY INSTRUCTIONS” and this “USER'S MANUAL” thoroughly to ensure correct usage through understanding. After reading, store this instruction manual in a safe place for future reference.

ENGLISH

- NOTE** • The information in this manual is subject to change without notice.
- The manufacturer assumes no responsibility for any errors that may appear in this manual
  - The reproduction, transmission or use of this document or contents is not permitted without express written authority.

### TRADEMARK ACKNOWLEDGEMENT :

- PS/2, VGA and XGA are registered trademarks of the International Business Machines Corporation.
- Apple, Mac and ADB are registered trademarks of Apple Computer, Inc.
- VESA and SVGA are trademarks of the Video Electronics Standard Association.
- Windows is a registered trademark of Microsoft Corporation.
- All other trademarks are the property of their respective owners.

## CONTENTS

|                                     | Page |                                      | Page |
|-------------------------------------|------|--------------------------------------|------|
| <b>PROJECTOR FEATURES</b> .....     | 2    | <b>CORRECTING KEYSTONE</b>           |      |
| <b>PREPARATIONS</b> .....           | 2    | <b>DISTORTIONS</b> .....             | 20   |
| <b>PART NAMES</b> .....             | 4    | <b>USING THE MAGNIFY</b>             |      |
| <b>SETTING UP</b>                   |      | <b>FEATURE</b> .....                 | 21   |
| <b>THE PROJECTOR</b> .....          | 6    | <b>FREEZING THE SCREEN</b> .....     | 21   |
| <b>CONNECTING</b>                   |      | <b>SIGNAL SEARCHING</b> .....        | 22   |
| <b>YOUR DEVICES</b> .....           | 8    | <b>SELECTING THE ASPECT</b>          |      |
| <b>USING THE REMOTE</b>             |      | <b>RATIO</b> .....                   | 22   |
| <b>CONTROL</b> .....                | 13   | <b>TEMPORARILY BLANKING</b>          |      |
| <b>TURNING ON THE POWER</b> .....   | 14   | <b>THE SCREEN</b> .....              | 22   |
| <b>TURNING OFF THE POWER</b> .....  | 16   | <b>USING THE MENU</b>                |      |
| <b>ADJUSTING THE VOLUME</b> .....   | 17   | <b>FUNCTIONS</b> .....               | 23   |
| <b>TEMPORARILY MUTING</b>           |      | <b>OPERATING THE PC SCREEN</b> ..... | 24   |
| <b>THE SOUND</b> .....              | 17   | <b>THE LAMP</b> .....                | 25   |
| <b>ADJUSTING THE POSITION</b> ..... | 18   | <b>THE AIR FILTER</b> .....          | 27   |
| <b>USING THE AUTOMATIC</b>          |      | <b>OTHER CARE</b> .....              | 29   |
| <b>ADJUSTMENT FEATURE</b> .....     | 19   | <b>REGULATORY NOTICES</b> .....      | 30   |

## PROJECTOR FEATURES

This liquid crystal projector is used to project various computer signals as well as NTSC / PAL / SECAM video signals onto a screen. Little space is required for installation and large images can easily be realized.

### ● **Ultra High Brightness**

Crisp, ultra-bright presentations is achieved by using a UHB (ultra high brightness) lamp and a highly efficient optical system

### ● **Partial Magnification Function**

Interesting parts of images can be magnified for closer viewing

### ● **Keystone Distortion Correction**

Quick correction of distorted images electrically

### ● **Whisper Mode Equipped**

Special mode is available for reducing projector noise to achieve quieter operation

## PREPARATIONS

Your projector should come with the items shown below. Check to make sure that all the items are included. Contact your dealer if anything is missing.

**NOTE** • Keep the original packing material for future reshipment.

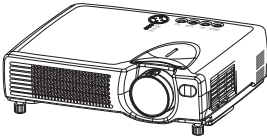

**Projector  
(with Lens Cap)**



**Power cord  
(US Type)**

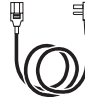

**Power cord  
(UK Type)**

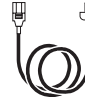

**Power cord  
(Europe Type)**



**User's Manuals  
(Vol.1/Vol.2)  
Safety Instructions**

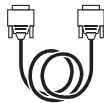

**RGB cable**



**Video/Audio cable**



**USB mouse  
cable**



**Soft carrying case**



**Two AA batteries  
(for the remote  
control)**

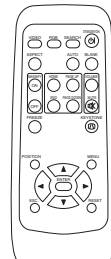

**Remote control**

## 1 Connect your devices to the projector

Connect your computer, VCR and/or other devices you will be using to the projector.

## 2 Insert the batteries into the remote control

13

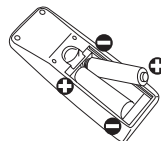

## 3 Connect the power cord

- (1) Connect the connector of the electrical power cord to the AC inlet of the main unit.
- (2) Firmly plug the power cord's plug into the outlet

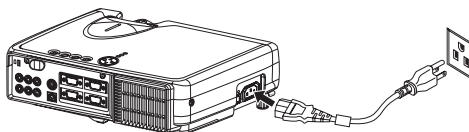



# THE REMOTE CONTROL

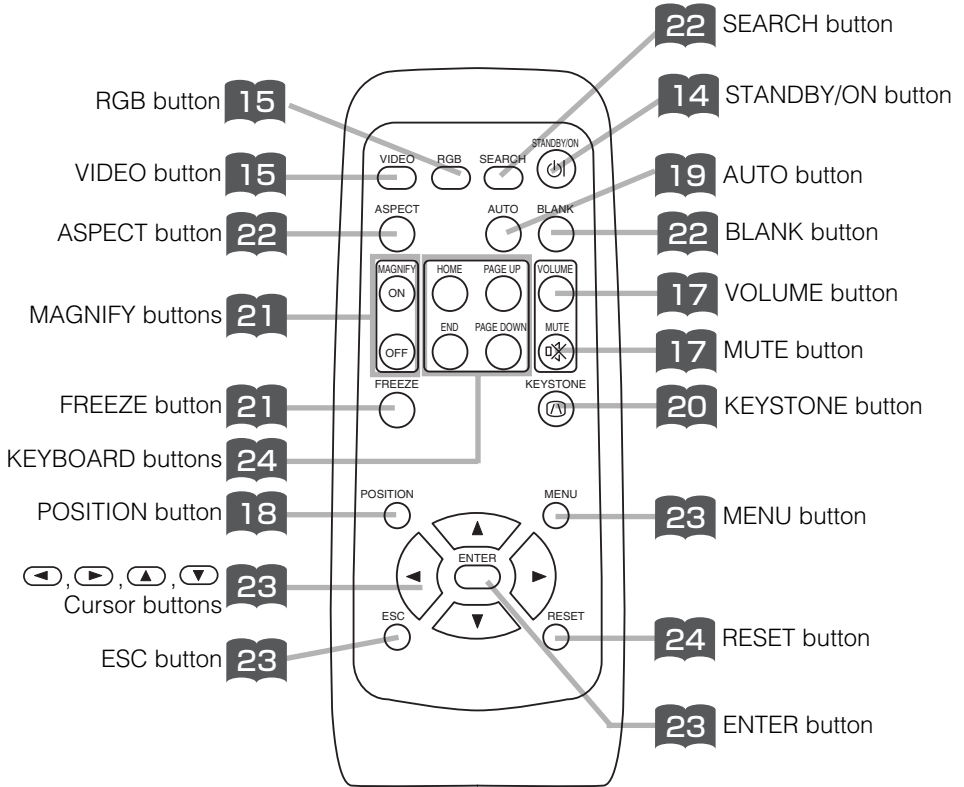

# SETTING UP THE PROJECTOR

- CAUTION** • Install the projector in a suitable environment according to instructions of the accompanying manual “SAFETY INSTRUCTIONS” and this manual.
- If you press the elevator buttons without holding the projector, the projector might crash down, overturn, smash your fingers and possibly result in malfunction. To prevent damaging the projector and injuring yourself, ALWAYS HOLD THE PROJECTOR whenever using the elevator buttons to adjust the elevator feet.

## *Adjusting the Projector's Elevator Feet*

You can use the elevator feet to make adjustments if the surface on which you need to set the projector is uneven or if you otherwise need to adjust the angle of projection. The adjustment range of the elevator feet is 0 to 9 degrees.

### **1 Press and hold in the elevator buttons**

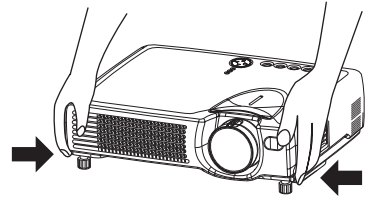

### **2 Raise or lower the projector to the desired height and then release the elevator buttons**

When you release the elevator buttons, the elevator feet will lock into position.

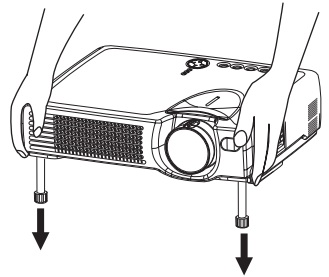

### **3 As necessary, you can also finely adjust the height of the projector by twisting the elevator feet by hand**

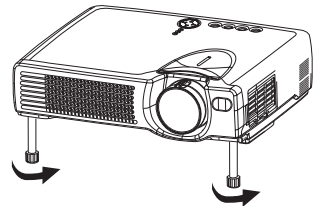

*and Projection*

determine the s

**W**



**W**





## CONNECTING YOUR DEVICES

*Devices You Can Connect to the Projector  
(Refer to this section for planning your device configuration to use for your presentation.)*

**CAUTION** • Incorrect connecting could result in fire or electrical shock. Please read this manual and the separate “SAFETY INSTRUCTIONS”.

**ATTENTION** Precautions to observe when connecting other devices to the projector

- Whenever attempting to connect other devices to the projector, please thoroughly read the manual of each device to be connected.
- **TURN OFF ALL DEVICES** prior to connecting them to the projector. Attempting to connect a live device to the projector may generate extremely loud noises or other abnormalities that may result in malfunction and/or damage to the device and/or projector. Refer to the “TECHNICAL” of the USER’S MANUAL (Vol.2) for the pin assignment of connectors and RS-232C communication data.
- Make sure that you connect devices to the correct port. Incorrect connection may result in malfunction and/or damage to the device and/or projector.
- A component cable and some other cables have to be used with core set. Use the accessory cable or a designated-type cable for the connection. For cables that have a core only at one end, connect the core to the projector.
- Secure the screws on the connectors and tighten.



Indicates the corresponding reference page

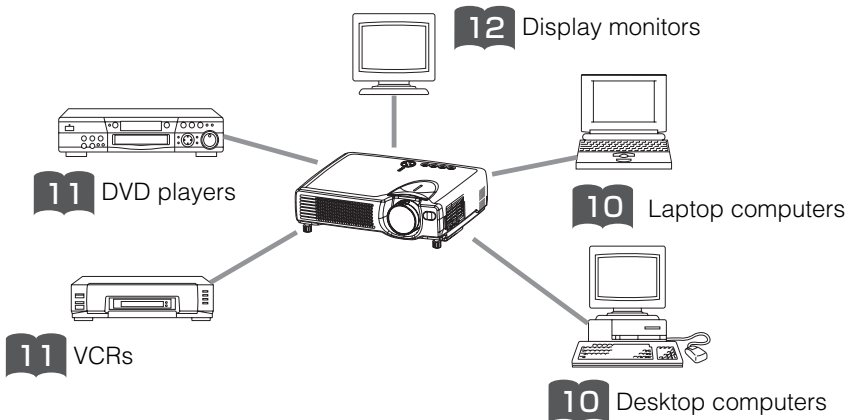

## Ports and Cables

Refer to the table below to find out which projector port and cable to use for connecting a given device. Use this table for determining which cables to prepare.

| Function              | Projector Port                                 | Connection Cables                                                                              |
|-----------------------|------------------------------------------------|------------------------------------------------------------------------------------------------|
| RGB input             | RGB IN 1                                       | Accessory RGB cable or optional RGB cable with D-sub 15-pin shrink jack and inch thread screws |
|                       | RGB IN 2                                       |                                                                                                |
| RGB output            | RGB OUT                                        |                                                                                                |
| USB mouse control     | USB                                            | Accessory USB cable                                                                            |
| PS/2 mouse control    | CONTROL                                        | Optional PS/2 mouse cable                                                                      |
| ADB mouse control     |                                                | Optional ADB mouse cable                                                                       |
| Serial mouse control  |                                                | Optional serial mouse cable                                                                    |
| RS-232C communication |                                                | Optional RS-232C cable                                                                         |
| S-video input         | S-VIDEO IN                                     | Optional S-video cable with mini DIN 4-pin jack                                                |
| Video input           | VIDEO IN                                       | Accessory audio/video cable                                                                    |
| Component video input | COMPONENT VIDEO Y                              | Optional component video cable                                                                 |
|                       | COMPONENT VIDEO C <sub>B</sub> /P <sub>B</sub> |                                                                                                |
|                       | COMPONENT VIDEO C <sub>R</sub> /P <sub>R</sub> |                                                                                                |
| Audio input           | AUDIO IN L                                     | Accessory audio/video cable or optional audio cable with RCA jack                              |
|                       | AUDIO IN R                                     |                                                                                                |

### **NOTE** About Plug-and-Play Capability

- This projector is compatible with VESA DDC 1/2B. Plug-and-Play can be achieved by connecting this projector to computers that are VESA DDC (display data channel) compatible. Please take advantage of this function by connecting the accessory RGB cable to the RGB IN 1 port (DDC 1/2B compatible). Plug-and-Play may not work properly if any other type of connection is attempted.
- Plug-and-Play is a system composed of the computer, its operating system and peripheral equipment (i.e. display devices).
- Please use the standard drivers as this projector is a Plug-and-Play monitor.
- Plug-and-Play may not function properly with some type of computers. Use the RGB IN 2 port if Plug-and-Play does not function correctly.

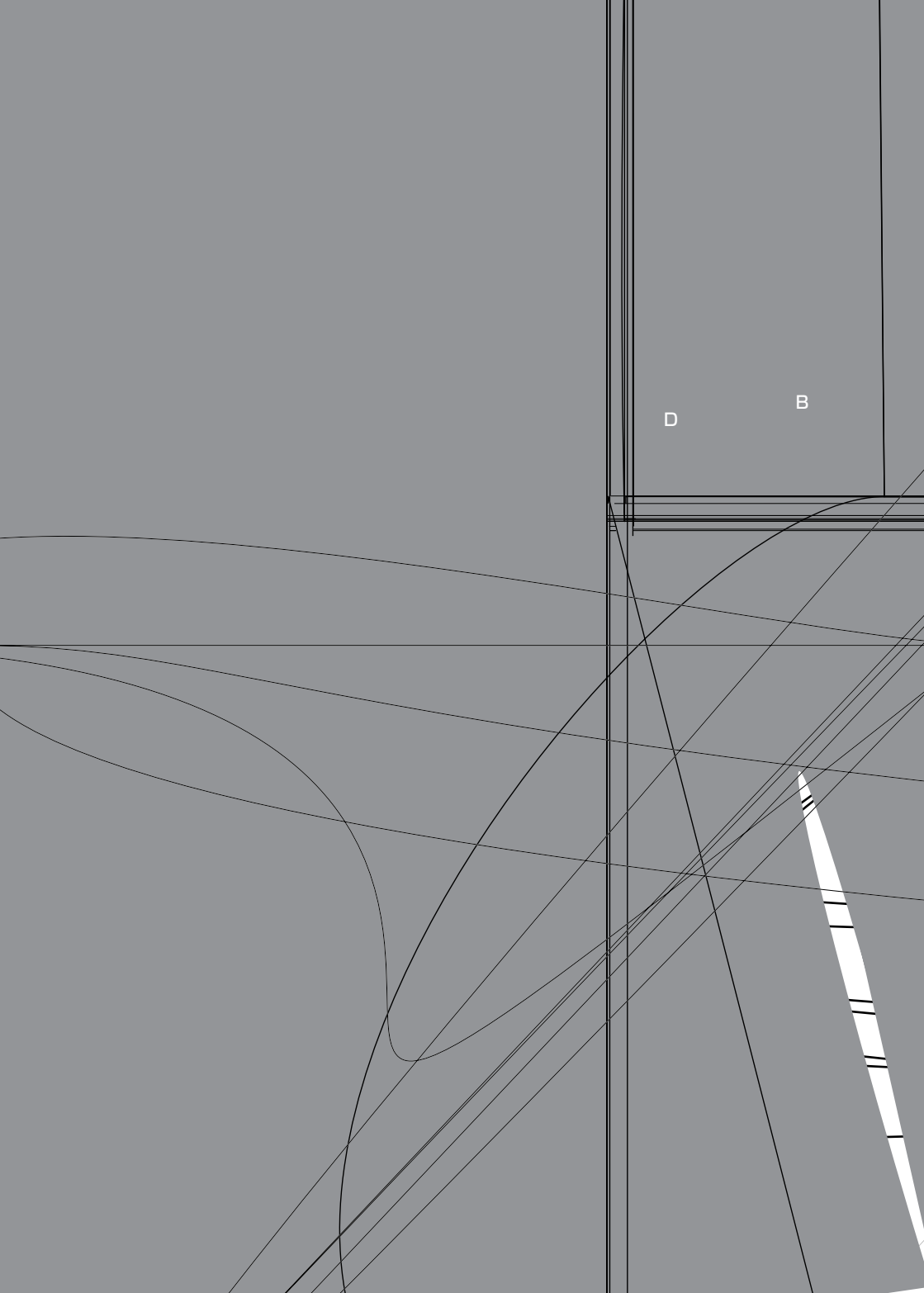

D

B

# Connecting to a DVD Player

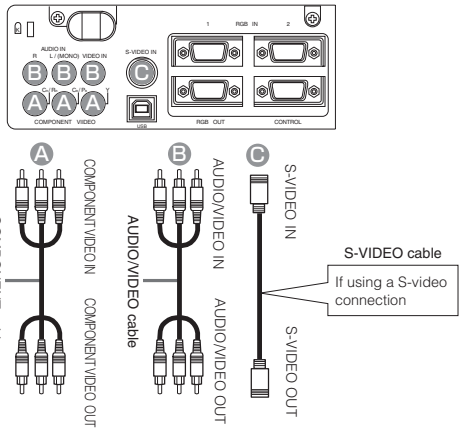

S-VIDEO cable  
If using a S-video connection

If using a component video connection      If using an audio/video connection

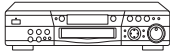

**DVD player**

# Connecting to a VCR

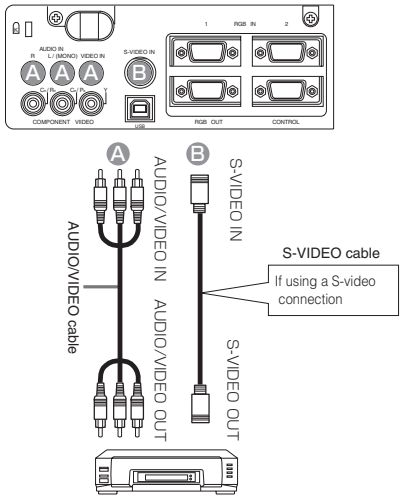

S-VIDEO cable  
If using a S-video connection



**VCR**

# CONNECTING YOUR DEVICES (continued)

## Connecting to a Display Monitor

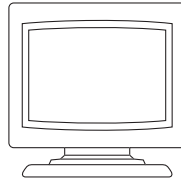
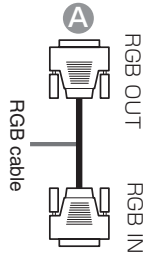
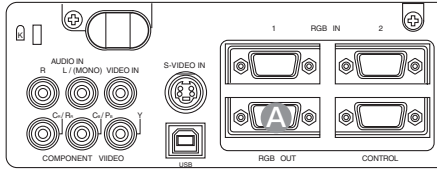

**Display monitor**

face.

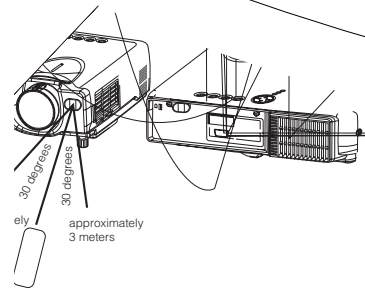





**6 Use the zoom ring to adjust the screen size**

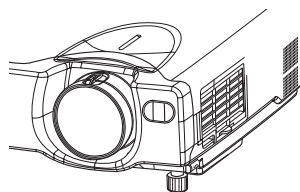



# TURNING OFF THE POWER

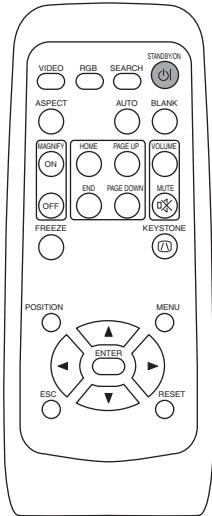

**Control panel**

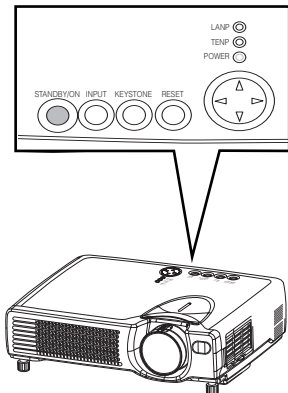

## NOTE

- Except in emergencies, follow the above-mentioned procedure for turning power off.

## 1 Press the **STANDBY/ON** button (control panel or remote control)

The message "Power off?" will appear on the screen for approximately 5 seconds.



## 2 Press the **STANDBY/ON** button again (control panel or remote control)

Press the STANDBY/ON button again while the "Power off?" message is visible. The projector lamp goes off and starts cooling down. The POWER indicator blinks orange while the lamp cools down. (Pressing the STANDBY/ON button while the POWER indicator is blinking orange has no effect.)

The system goes into the STANDBY mode after cooling down and the POWER indicator stops blinking orange and then lights to solid orange.



## 3 Check that the **POWER** indicator stops blinking and lights to solid orange. Switch the power switch to [O] (OFF).

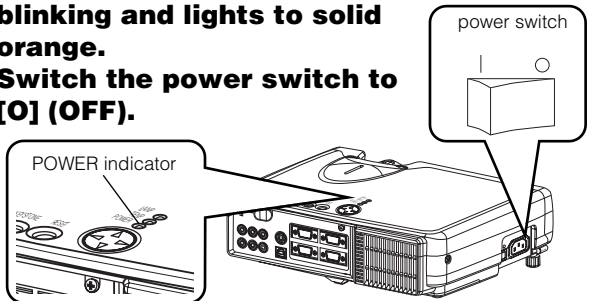

## 4 Confirm that the **POWER** indicator has gone off and then attach the lens cap.

When the projector has completed powering down, the POWER indicator will go off.

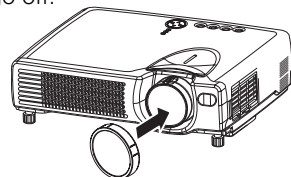

# ADJUSTING THE VOLUME

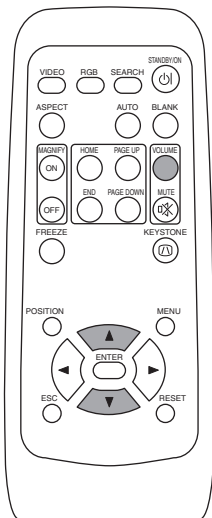

## 1 Press the **VOLUME** button

As illustrated on the right, a dialog will appear on the screen to aid you in adjusting the volume.

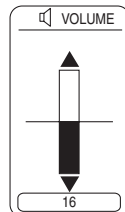

ENGLISH

## 2 Press the **▲**, **▼** buttons to adjust the volume

Press the VOLUME button again to close the dialog and complete this operation. (Even if you don't do anything, the dialog will automatically disappear after a few seconds.)



Press this to increase the volume



Press this to decrease the volume

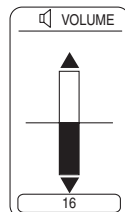

# TEMPORARILY MUTING THE SOUND

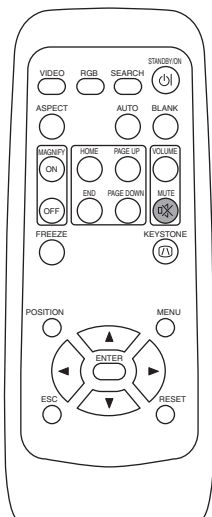

## 1 Press the **MUTE** button

As illustrated on the right, a dialog will appear on the screen indicating that you have muted the sound. Press the VOLUME button to close the dialog. (Even if you don't do anything, the dialog will automatically disappear after a few seconds.)

Press the MUTE button again to restore the sound.

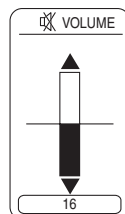

# ADJUSTING THE POSITION

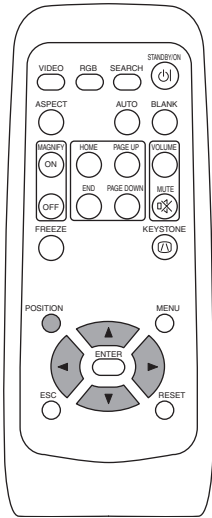

## 1 Press the **POSITION** button

As illustrated on the right, a dialog will appear on the screen to aid you in adjusting the position.



## 2 Use the **←, →, ▲, ▼** buttons to adjust the position

When you want to initialize the position, press the RESET button during adjustment.

Press the POSITION button again to close the dialog and complete this operation. (Even if you don't do anything, the dialog will automatically disappear after a few seconds.)

This function is only available for RGB IN 1/2 input.

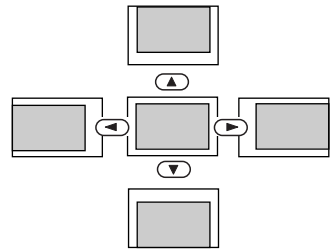

# USING THE AUTOMATIC ADJUSTMENT FEATURE

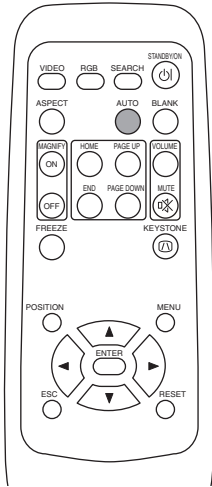

## 1 Press the AUTO button



### Automatic Adjustment for RGB Input

Horizontal position (H. POSIT), vertical position (V. POSIT), clock phase (H. PHASE) and horizontal size (H. SIZE) are automatically adjusted.

Make sure that the application window is set to its maximum size prior to attempting to use this feature. Dark pictures may still be incorrectly adjusted. Use a bright screen when adjusting.

### Automatic Adjustment for Video Input

The signal type best suited for the respective input signal is selected automatically.

This feature is available only if VIDEO is set to AUTO in the INPUT menu.

#### NOTE

The automatic adjustment operation requires approximately 10 seconds. Also, please note that it may not function correctly with some input signals.

# CORRECTING KEYSTONE DISTORTIONS

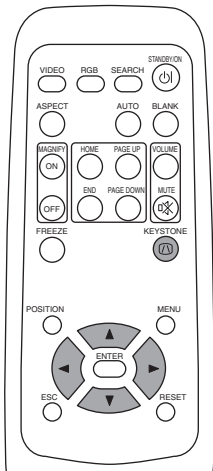

## 1 Press the **KEYSTONE** button

As illustrated on the right, a dialog will appear on the screen to aid you in correcting the distortion.

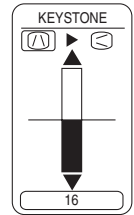

## 2 Use the **◀, ▶** buttons to select the direction of distortion to correct (◀/▶)



## 3 Use the **▲, ▼** buttons to correct the distortion

Press the KEystone button again to close the dialog and complete this operation. (Even if you don't do anything, the dialog will automatically disappear after a few seconds.)



### NOTE

- This function may not work well with some types of input signals.
- The adjustable range for correcting keystone distortions will vary with the type of input signal.

# USING THE MAGNIFY FEATURE

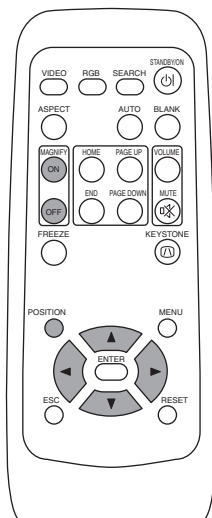

## 1 Press the **MAGNIFY (ON)** button

The projector enters MAGNIFY mode.



## 2 Press the **POSITION** button, then use the **←, →, ↑, ↓** buttons to select the area to enlarge and then press the **POSITION** button again to confirm your selection



## 3 Press the **↑, ↓** buttons to zoom in and out of the selected area.

Press the MAGNIFY (OFF) button to exit MAGNIFY mode and restore the screen to normal. (The projector will also automatically exit MAGNIFY mode if there is a change in the input signal's state.)



### NOTE

The projector will automatically exit from MAGNIFY mode if either the INPUT SELECT, AUTO, ASPECT or VIDEO feature is used, or, if there is a change in the input signal's state.

# FREEZING THE SCREEN

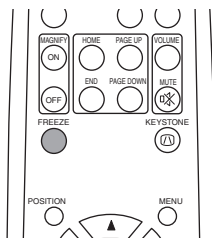

## 1 Press the **FREEZE** button

The [II] icon appears and the screen will freeze at the current image. Press the FREEZE button again and the [▶] appears as the projector exits FREEZE mode.



### NOTE

- The projector will automatically exit from FREEZE mode if either the POSITION, VOLUME, MUTE, AUTO, BLANK ON/OFF or MENU ON/OFF feature is used, or, if there is a change in the input signal's state.
- If the projector continues projecting the same image for a long time (i.e. you forget to exit FREEZE mode), the image might possibly remain as an afterimage. Do not leave the projector in FREEZE mode for too long.

# SIGNAL SEARCHING

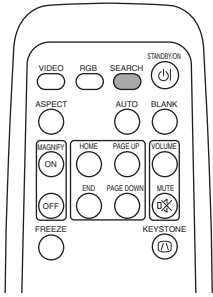

## 1 Press the **SEARCH** button

When you press the SEARCH button, the projector begins searching for input signals. If it detects an input signal, the search will cease and the projector will project the detected signal. If the projector is unable to find an input signal at any of its ports, it will return to the state it was in prior to the search.

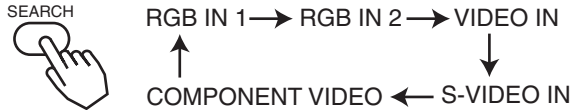

# SELECTING THE ASPECT RATIO

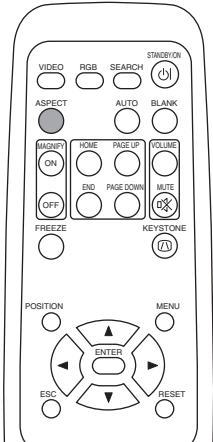

## 1 Press the **ASPECT** button



RGB IN 1, RGB IN 2, COMPONENT VIDEO  
(HDTV signals : 1125i (1035i/1080i), 750p)

4:3 ↔ 16:9

VIDEO IN, S-VIDEO IN, COMPONENT VIDEO  
(Non-HDTV signals : 525i, 525p, 625i)

4:3 → 16:9 → SMALL  
↑

# TEMPORARILY BLANKING THE SCREEN

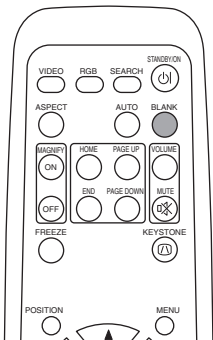

## 1 Press the **BLANK** button

The input signal screen is shut off, and a blank screen appears. You can set the blank screen using the menu (from the SCREEN menu, select BLANK). Press the BLANK button again to remove the blank screen, and return to the input signal screen.



# USING THE MENU FUNCTIONS

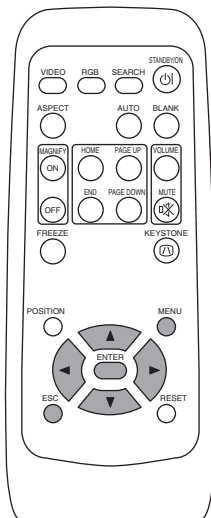

## 1 Press the MENU button

The menu display appears on the screen. The projector has the following menus: MAIN, PICTURE 1, PICTURE 2, INPUT, SCREEN, and OPTION. Select a menu using the / buttons. The current settings of the items that can be manipulated via the selected menu appear.



## 2 Select a menu using the / buttons, then press the or ENTER button.

The display of the selected menu appears.

[ex. Adjusting SHARPNESS]

Use the / buttons to select PICTURE 1, then press the or ENTER button.

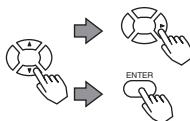

| MENU      |                |
|-----------|----------------|
| MAIN      | COLOR BAL R -1 |
| PICTURE-1 | COLOR BAL B +1 |
| PICTURE-2 | SHARPNESS -1   |
| INPUT     | COLOR +1       |
| SCREEN    | TINT -1        |
| OPTION    |                |
| SELECT    |                |

## 3 Select an item using the / buttons, then press the or ENTER button.

The operation display of the selected item appears. To adjust a numerical value, press the or ENTER button again to switch to the single menu (small display showing only the operation display area).

[ex. Adjusting SHARPNESS]

Use the / buttons to select SHARPNESS, then press the or ENTER button.

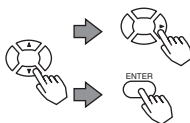

| MENU      |             |
|-----------|-------------|
| MAIN      | COLOR BAL R |
| PICTURE-1 | COLOR BAL B |
| PICTURE-2 | SHARPNESS   |
| INPUT     | COLOR       |
| SCREEN    | TINT        |
| OPTION    |             |
| SELECT    |             |

## 4 Press the / buttons to adjust the level.

Press the MENU button to hide the menu and finish your operation. Alternatively, press the or ESC button to return to the previous display.

[ex. Adjusting SHARPNESS]

Use the / buttons to adjust the SHARPNESS.





# OPERATING THE PC SCREEN

You can use the remote control as a simplified mouse or keyboard.

**CAUTION** Caution: Mistaken use of the mouse/keyboard control could damage your equipment.

- Only connect to a PC.
- Before connecting, read the manuals of the device you will connect.
- Do not unplug the connector cables while the computer is operating.

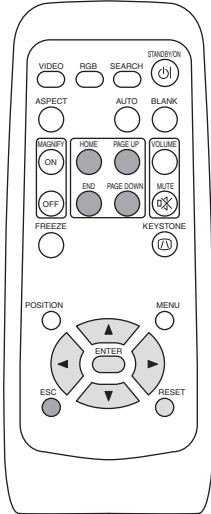

## PS/2, ADB, Serial Mouse Control

1. Turn off the projector and PC power, and connect the projector's CONTROL terminal to the computer via the mouse cable.
  2. If a USB cable is connected, disconnect it. If a USB cable is connected, the USB control function is given priority, and mouse control from the CONTROL terminal will not function.
  3. Turn on the projector power, then the computer.
- The functions in the table below can be controlled. If you have difficulty with control, restart the computer (either from the software or by pressing the restart button).

| Available Functions    | Remote Control Operation |
|------------------------|--------------------------|
| Move Pointer           | Use ◀ ▶ ▲ ▼ buttons      |
| Left click with mouse  | Press ENTER button       |
| Right click with mouse | Press RESET button       |

## USB Mouse/Keyboard Control

1. Connect the projector's USB terminal to the computer using a USB cable.
- The functions in the table below can be controlled.

| Available Functions            | Remote Control Operation |
|--------------------------------|--------------------------|
| Move Pointer                   | Use ◀ ▶ ▲ ▼ buttons      |
| Left click with mouse          | Press ENTER button       |
| Right click with mouse         | Press RESET button       |
| Press keyboard's HOME key      | Press HOME button        |
| Press keyboard's END key       | Press END button         |
| Press keyboard's PAGE UP key   | Press PAGE UP button     |
| Press keyboard's PAGE DOWN key | Press PAGE DOWN button   |
| Press keyboard's ESC key       | Press ESC button         |

## NOTES

- It may not be possible to control notebook PCs, and other computers with built-in pointing devices (e.g. track balls), using this remote control. In this case, before connecting go into BIOS (system setup) and select external mouse, and disable the pointing devices. In addition, the mouse may not function if the computer does not have the needed utility program. See your computer's hardware manual for details.
- The USB control can be used with Windows 95 OSR 2.1 or higher. It may not be possible to use the remote control, depending on the computer's configurations and mouse drivers.
- The USB control can only be used for the functions listed above. You cannot do things like press two buttons at once (for instance, pressing two buttons at the same time to move the mouse pointer diagonally).
- This function is not available while the lamp is warming up (the POWER indicator flashes green), while adjusting the volume and display, correcting for trapezoidal distortion, zooming in on the screen, using the BLANK function, or displaying the menu screen.

# THE LAMP



**HIGH VOLTAGE  
HIGH TEMPERATURE  
HIGH PRESSURE**

ENGLISH

Before replacing the lamp, check the serial number of the replacement lamp bulb (sold separately: DT00511 for CP-S317/DT00521 for CP-X327), then contact your local dealer. Before replacing the lamp, turn off the power, and unplug the power cord, then wait at least 45 minutes, in order to ensure that the lamp is properly cooled. Removing the lamp bulb while it is still hot could cause burns, or cause the lamp bulb to burst.

**⚠ WARNING** The LCD projector uses a glass lamp bulb. It is a mercury lamp with high internal pressure. High-pressure mercury lamps can break with a loud bang, or burn out, if jolted or scratched, or through wear over time. Each lamp has a different lifetime, and some may burst or burn out soon after you start using them. In addition, when the bulb bursts, it is possible for shards of glass to fly into the lamp housing, and for gas containing mercury to escape from the projector's vent holes.

- Handle with care: jolting or scratching could cause the lamp bulb to burst during use.
- If the replace lamp indicator (see "Related Messages" (Vol.2 ) and "Regarding the indicator Lamps" (Vol.2 )) comes on, replace the lamp as soon as possible. Using the lamp for long periods of time, or past the replacement date, could cause it to burst. Do not use old (used) lamps; this is a cause of breakage.
- If the lamp breaks soon after the first time it is used, it is possible that there are electrical problems elsewhere besides the lamp. If this happens, contact your local dealer.
- If the lamp should break (it will make a loud bang when it does), ventilate the room well, and make sure not to breathe the gas that comes out of the projector vents, or get it in your eyes or mouth.
- If the lamp should break (it will make a loud bang when it does), unplug the power cord from the outlet, and make sure to request a replacement lamp from your local dealer. Note that shards of glass could damage the projector's internals, or cause injury during handling, so please do not try to clean the projector or replace the lamp yourself.
- Obey local ordinances when disposing of used lamps. In most cases, it is possible to dispose of used bulbs in the same manner as used glass bottles, but in some cases, bulbs are sorted separately.
- Do not use the projector with the lamp cover removed.

THE LAMP (continued)

*Replacing the Lamp*

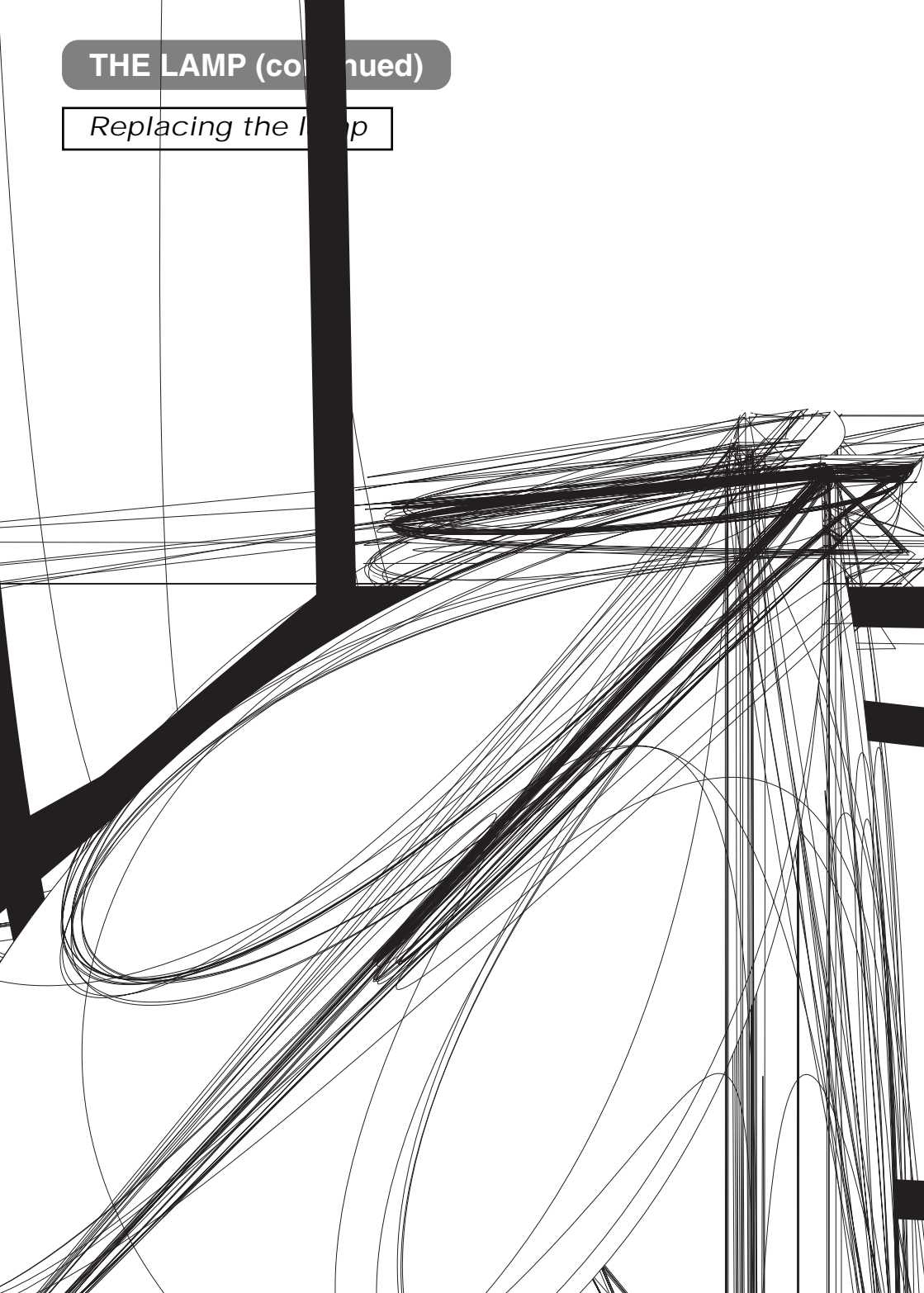

# THE AIR FILTER

## *Caring for the air filter*

The air filter should be cleaned about every 100 hours. If the LAMP indicator and TEMP indicator blink red simultaneously, or a message prompts you to clean the air filter when you turn on the unit, the filter needs to be cleaned. (See "Related Messages" (Vol.2 **7**) and "Regarding the Indicator Lamps" (Vol.2 **8**) for details.)

ENGLISH

### **1 Turn off the projector, and unplug the power cord**

### **2 Apply a vacuum cleaner to the top of the air filter cover to clean the air filter**

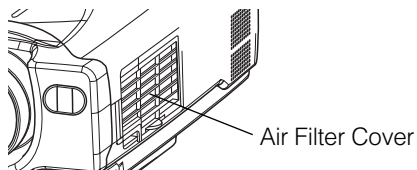

### **3 Turn on the projector, and use the menu to reset the filter timer**

- To reset the air filter timer, from the OPTION menu, select FILTER TIME.

## THE AIR FILTER (continued)

### *Replacing the air filter*

If the soiling will not come off the air filter, or it becomes damaged, then it needs to be replaced. Please contact your local dealer, after confirming the model of your separately sold replacement air filter. (See "Optional Parts" on Vol.2 10.)

**1 Turn off the projector, and unplug the power cord. Prepare a new air filter (one specified for your projector)**

**2 Remove the air filter cover and air filter**

**3 Insert the new filter, and replace the filter cover**

**4 Turn on the projector power, and using the menu, reset the filter timer**

- To reset the lamp timer, from the OPTION menu, select FILTER TIME.

**ATTENTION** • Make sure to turn off the power and unplug the power cord before caring for the unit. Please carefully read "Safety Instructions", in order to care for your projector correctly.

- Do not use with air filter cover removed.
- If the air filter becomes clogged by dust or the like, internal temperature rises and could cause malfunction. The power is automatically turned off in order to prevent the unit from overheating internally.

### **Caring for the inside of the projector :**

In order to ensure the safe use of your projector, please have it cleaned and inspected by your local dealer about once every 2 years. Never try to care for the inside of the unit yourself. Doing so is dangerous.

### **Caring for the lens :**

Lightly wipe the lens with a commercially available lens-cleaning wipe. Do not touch the lens directly with your hand.

### **Caring for the cabinet and remote control transmitter :**

Wipe lightly with gauze or a soft cloth. If soiling is severe, dip a soft cloth in water or a neutral cleanser diluted in water, and wipe lightly after wringing well. Then, wipe lightly with a soft, dry cloth.

**ATTENTION** • Make sure to turn off the power and unplug the power cord before caring for the unit. Please carefully read "Safety Instructions" in this manual, in order to care for your projector correctly.

- Do not use cleaners or chemicals other than those listed above, including benzene and paint thinner.
- Do not use aerosols or sprays.
- Do not polish or wipe with hard objects.

# REGULATORY NOTICES

## FCC Statement Warning

**WARNING:** This equipment has been tested and found to comply with the limits for a Class B digital device, pursuant to Part 15 of the FCC Rules. These limits are designed to provide reasonable protection against harmful interference in a residential installation. This equipment generates, uses, and can radiate radio frequency energy and, if not installed and used in accordance with the instructions, may cause harmful interference to radio communications. However, there is no guarantee that interference will not occur in a particular installation. If this equipment does cause harmful interference to radio or television reception, which can be determined by turning the equipment off and on, the user is encouraged to try to correct the interference by one or more of the following measures:

- Reorient or relocate the receiving antenna.
- Increase the separation between the equipment and receiver.
- Connect the equipment into an outlet on a circuit different from that to which the receiver is connected.
- Consult the dealer or an experienced radio/TV technician for help.

**INSTRUCTIONS TO USERS:** This equipment complies with the requirements of FCC (Federal Communication Commission) equipment provided that the following conditions are met.

The cables may have to be used with the core set to the projector side. Use the cables which are included with the projector or specified.

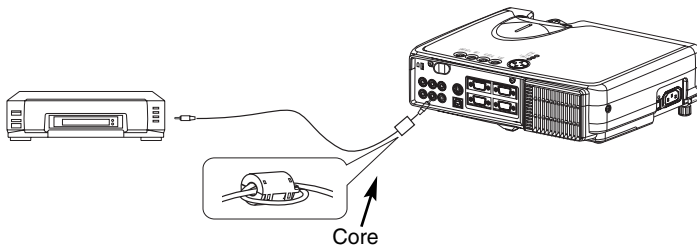

**CAUTION:** Changes or modifications not expressly approved by the party responsible for compliance could void the user's authority to operate the equipment.

## For the Customers in CANADA

**NOTICE:** This Class B digital apparatus complies with Canadian ICES-003.

## Pour les utilisateurs au Canada

**AVIS:** Cet appareil numérique de la Classe B est conforme à la norme NMB-003 du Canada.

# HITACHI

Liquid Crystal Projector

## CPS317/CPX327/EDS3170/EDX3270

(CPS317W/CPX327W/EDS3170/EDX3270)

### USER'S MANUAL Vol.2 Extended

Please read this user's manual thoroughly to ensure correct usage through understanding.

### BEDIENUNGSANLEITUNG Teil 2 Fortsetzung

Bitte lesen Sie diese Benutzerhandbuch zugunsten der korrekten Bedienung aufmerksam.

### MANUEL D'UTILISATION Vol.2 Développé

Nous vous recommandons de lire attentivement ce manuel pour bien assimiler le fonctionnement de l'appareil.

### MANUALE D'ISTRUZIONI Vol.2 Ampliato

Vi preghiamo voler leggere attentamente il manuale d'istruzioni in modo tale da poter comprendere quanto riportato ai fini di un corretto utilizzo del proiettore.

### MANUAL DE USUARIO Vol.2 Ampliado

Lea cuidadosamente este manual del usuario para poder utilizar correctamente el producto.

### GEBRUIKSAANWIJZING Vol.2 Uitgebreid

Lees voor het gebruik alstublieft deze handleiding aandachtig door, om volledig profijt te hebben van de uitgebreide mogelijkheden.

### BRUKERHÅNDBOK Vol.2 Utvidet

Vennligst les denne bruksanvisningen grundig for å være garantert driftssikker bruk.

### NSTRUÇÕES DO PROPRIETÁRIO Vol.2 Continuação

Para assegurar o uso correto do equipamento, por favor leia atentamente este manual do utilizador.

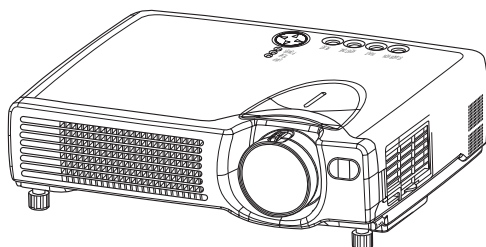

ENGLISH

DEUTSCH

FRANÇAIS

ITALIANO

ESPAÑOL

NEDERLANDS

NORSK

PORTUGÊS

TECHNICAL



# USER'S MANUAL Vol.2 (Extended)

Thank you for purchasing this projector.

**WARNING** • Please read the accompanying manual “SAFETY INSTRUCTIONS” and this “USER'S MANUAL” thoroughly to ensure correct usage through understanding. After reading, store this instruction manual in a safe place for future reference.

**NOTE** • The information in this manual is subject to change without notice.

- The manufacturer assumes no responsibility for any errors that may appear in this manual
- The reproduction, transmission or use of this document or contents is not permitted without express written authority.

### TRADEMARK ACKNOWLEDGEMENT :

- PS/2, VGA and XGA are registered trademarks of the International Business Machines Corporation.
- Apple, Mac and ADB are registered trademarks of Apple Computer, Inc.
- VESA and SVGA are trademarks of the Video Electronics Standard Association.
- Windows is a registered trademark of Microsoft Corporation.
- All other trademarks are the property of their respective owners.

## CONTENTS

|                                                                      | Page      |
|----------------------------------------------------------------------|-----------|
| <b>MULTIFUNCTIONAL SETTINGS .....</b>                                | <b>2</b>  |
| <b>WHAT TO DO WHEN YOU THINK A MACHINE DEFECT HAS OCCURRED .....</b> | <b>7</b>  |
| <b>SPECIFICATIONS .....</b>                                          | <b>10</b> |
| <b>WARRANTY AND AFTER-SERVICE.....</b>                               | <b>11</b> |

.....  
For "TECHNICAL" see the end of this manual.

# MULTIFUNCTIONAL SETTINGS

This device has 6 separate menus: **MAIN, PICTURE 1, PICTURE 2, INPUT, SCREEN, OPTION.** Each of these menus is operated using the same methods. The basic operations of these menus are as follows.

**Menu screen display :** Press the "MENU" button.

**Menu selection :** Choose a menu name using the  $\triangle$  /  $\nabla$  button, and press the  $\rightarrow$  button or the ENTER button.

**Item selection :** Choose an item using the  $\triangle$  /  $\nabla$  button, and press the  $\rightarrow$  button or the ENTER button.

**Return menu to last previous screen:** Press the  $\leftarrow$  button or the ESC button.

**Execution of settings and/or adjustments:** Operate by using the  $\triangle$  /  $\nabla$  button. (For further details, read the explanation for each separate menu.)

**Initialization of settings and/or adjustments:** During operation, press the RESET button. (Note that items whose functions are performed simultaneously with the operation of clock phase, language selection, automatic adjustment, etc., cannot be initialized.)

**End menu operations:** Press the MENU button, or do not perform any operation for several seconds.

## MAIN Menu

With the MAIN menu, the seven items shown in the Table below can be performed.

Perform each operation in accordance with the instructions in the Table.

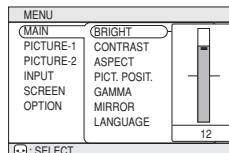

Example : MAIN Menu (BRIGHT)

## MAIN Menu

| Item               | Description                                                                                                                                                                                                                                                                                                                                                                                                                                                                                                               |
|--------------------|---------------------------------------------------------------------------------------------------------------------------------------------------------------------------------------------------------------------------------------------------------------------------------------------------------------------------------------------------------------------------------------------------------------------------------------------------------------------------------------------------------------------------|
| <b>BRIGHT</b>      | <b>Adjust Brightness:</b> Light $\triangle$ $\leftrightarrow$ $\nabla$ Dark                                                                                                                                                                                                                                                                                                                                                                                                                                               |
| <b>CONTRAST</b>    | <b>Adjust Contrast:</b> Strong $\triangle$ $\leftrightarrow$ $\nabla$ Weak                                                                                                                                                                                                                                                                                                                                                                                                                                                |
| <b>ASPECT</b>      | <b>Select Aspect Ratio:</b><br>At RGB Input or Hi-Vision 1125i(1035i/1080i)/750p of COMPONENT VIDEO Input:<br>4:3 $\nabla$ $\leftrightarrow$ $\triangle$ 16:9<br>At VIDEO Input, S-VIDEO Input or 525i/525p/625i of COMPONENT VIDEO Input:<br>4:3 $\nabla$ $\leftrightarrow$ $\triangle$ 16:9 $\nabla$ $\leftrightarrow$ $\triangle$ SMALL<br>• The SMALL picture may not be displayed correctly with certain input signals.                                                                                              |
| <b>PICT.POSIT.</b> | <b>Select Picture Position (for 16:9/SMALL Picture):</b><br>TOP $\nabla$ $\leftrightarrow$ $\triangle$ CENTER $\nabla$ $\leftrightarrow$ $\triangle$ BOTTOM                                                                                                                                                                                                                                                                                                                                                               |
| <b>GAMMA</b>       | <b>Select Gamma Mode:</b><br>NORMAL $\nabla$ $\leftrightarrow$ $\triangle$ CINEMA $\nabla$ $\leftrightarrow$ $\triangle$ DYNAMIC                                                                                                                                                                                                                                                                                                                                                                                          |
| <b>MIRROR</b>      | <b>Select Mirror Status:</b><br>NORMAL $\nabla$ $\leftrightarrow$ $\triangle$ H:INVERT $\nabla$ $\leftrightarrow$ $\triangle$ V:INVERT $\nabla$ $\leftrightarrow$ $\triangle$ H&V:INVERT                                                                                                                                                                                                                                                                                                                                  |
| <b>LANGUAGE</b>    | <b>Select Menu Language:</b><br>ENGLISH $\nabla$ $\leftrightarrow$ $\triangle$ FRANÇAIS $\nabla$ $\leftrightarrow$ $\triangle$ DEUTSCH $\nabla$ $\leftrightarrow$ $\triangle$ ESPAÑOL<br>$\nabla$ $\leftrightarrow$ $\triangle$ ITALIANO $\nabla$ $\leftrightarrow$ $\triangle$ NORSK $\nabla$ $\leftrightarrow$ $\triangle$ NEDERLANDS $\nabla$ $\leftrightarrow$ $\triangle$<br>日本語 $\triangle$ $\leftrightarrow$ $\nabla$ POTUGUÊS $\nabla$ $\leftrightarrow$ $\triangle$ 中文 $\nabla$ $\leftrightarrow$ $\triangle$ 한글 |

## PICTURE 1 Menu

With the PICTURE 1 menu, the five items shown in the Table below can be performed. Perform each operation in accordance with the instructions in the Table.

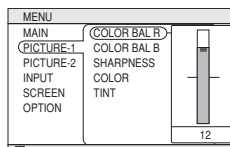

Example : PICTURE1 Menu (COLOR BAL R)

### PICTURE1 Menu

| Item        | Description                                                                  |
|-------------|------------------------------------------------------------------------------|
| COLOR BAL R | <b>Adjust Red Color Balance:</b> Dark ▲ ⇄ ▼ Light                            |
| COLOR BAL B | <b>Adjust Blue Color Balance:</b> Dark ▲ ⇄ ▼ Light                           |
| SHARPNESS   | <b>Adjust Sharpness (for VIDEO/S-VIDEO):</b> Clear ▲ ⇄ ▼ Soft                |
| COLOR       | <b>Adjust COLOR (for VIDEO/S-VIDEO/COMPONENT VIDEO):</b><br>Dark ▲ ⇄ ▼ Light |
| TINT        | <b>Adjust Tint (for VIDEO/S-VIDEO):</b> Green ▲ ⇄ ▼ Red                      |

## PICTURE 2 Menu

With the PICTURE 2 menu, the five items shown in the Table below can be performed. Perform each operation in accordance with the instructions in the Table.

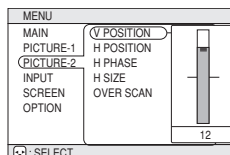

Example : PICTURE2 Menu (V POSITION)

### PICTURE2 Menu

| Item       | Description                                                                                                                                                                                                        |
|------------|--------------------------------------------------------------------------------------------------------------------------------------------------------------------------------------------------------------------|
| V POSITION | <b>Adjust Vertical Position (for RGB):</b> Up ▲ ⇄ ▼ Down                                                                                                                                                           |
| H POSITION | <b>Adjust Horizontal Position (for RGB):</b> Left ▲ ⇄ ▼ Right                                                                                                                                                      |
| H PHASE    | <b>Adjust Horizontal Phase (for RGB/COMPONENT VIDEO):</b><br>Right ▲ ⇄ ▼ Left<br>• Adjust to eliminate flicker.                                                                                                    |
| H SIZE     | <b>Adjust Horizontal Size (for RGB):</b> Large ▲ ⇄ ▼ Small<br>• If the horizontal size adjustment is excessive, the image may not be displayed correctly. In such a case, initialize H SIZE with the RESET button. |
| OVER SCAN  | <b>Select Over-scan Ratio (for VIDEO/S-VIDEO/COMPONENT VIDEO):</b><br>LARGE ▼ ⇄ ▲ MIDDLE ▼ ⇄ ▲ SMALL<br>• It is recommended to select SMALL to avoid flicker at the lower part of the picture.                     |

# MULTIFUNCTIONAL SETTINGS (continued)

## INPUT Menu

With the INPUT menu, the four items shown in the Table below can be performed. With inputting of RGB IN 1 and RGB IN 2 signals, the horizontal and vertical frequencies of the signals will be displayed on the initial screen of the INPUT menu.

Perform each operation in accordance with the instructions in the Table.

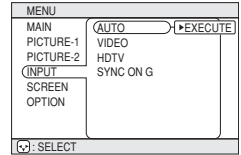

Example : INPUT Menu (AUTO)

## INPUT Menu

| Item             | Description                                                                                                                                                                                                                                                                                                                                                                                                                                                                                                                                                                                                                                                                                                                                                                                                                                     |
|------------------|-------------------------------------------------------------------------------------------------------------------------------------------------------------------------------------------------------------------------------------------------------------------------------------------------------------------------------------------------------------------------------------------------------------------------------------------------------------------------------------------------------------------------------------------------------------------------------------------------------------------------------------------------------------------------------------------------------------------------------------------------------------------------------------------------------------------------------------------------|
| <b>AUTO</b>      | <p><b>Auto Adjust (for RGB):</b> Automatically adjusts H POSITION, V POSITION, H PHASE, and H SIZE. Use this function with the maximum window size.</p> <p><b>Auto Adjust (for VIDEO/S-VIDEO):</b> Automatically selects the proper VIDEO mode for the current input signal. This function is active only when the AUTO mode is selected for the item VIDEO. Refer to the description for the item VIDEO below.</p> <ul style="list-style-type: none"> <li>• This function may not be available with a PAL60 signal and certain other signals.</li> <li>• The AUTO mode operation requires approximately 10 seconds.</li> <li>• For COMPONENT VIDEO, the signal type is identified automatically even if this function is inactive. For a HDTV signal, refer to the item HDTV below.</li> </ul>                                                 |
| <b>VIDEO</b>     | <p><b>Select Mode of Signal Type (for VIDEO/S-VIDEO):</b><br/>           AUTO (▼) ⇔ (▲) NTSC (▼) ⇔ (▲) PAL (▼) ⇔ (▲) SECAM (▼) ⇔ (▲) NTSC4.43 (▼) ⇔ (▲) M-PAL (▼) ⇔ (▲) N-PAL</p> <p>Selecting AUTO mode activates and performs the AUTO function for VIDEO/S-VIDEO. It automatically selects the proper mode from among those above. Use this function if the image becomes unstable with VIDEO/S-VIDEO. (e.g. The image becomes irregular, or lacks color.)</p> <ul style="list-style-type: none"> <li>• AUTO mode may not function correctly with a PAL60 signal and certain other signals.</li> <li>• The AUTO mode operation requires approximately 10 seconds.</li> <li>• For COMPONENT VIDEO, the signal type is identified automatically even if this function is inactive. For a HDTV signal, refer to the item HDTV below.</li> </ul> |
| <b>HDTV</b>      | <p><b>Select HDTV Signal Mode:</b><br/>           1080i (▼) ⇔ (▲) 1035i</p> <ul style="list-style-type: none"> <li>• If the selected HDTV mode is incompatible with the input signal, the picture may be distorted.</li> </ul>                                                                                                                                                                                                                                                                                                                                                                                                                                                                                                                                                                                                                  |
| <b>SYNC ON G</b> | <p><b>On/Off SYNC ON G Mode:</b><br/>           TURN ON (▼) ⇔ (▲) TURN OFF</p> <p>Selecting TURN ON turns on the SYNC ON G mode. The SYNC ON G mode allows reception of SYNC on G.</p> <ul style="list-style-type: none"> <li>• In the SYNC ON G mode, the picture may be distorted with certain input signals. In such a case, remove the signal connector so that no signal is received and turn SYNC ON G off, and then reconnect the signal.</li> </ul>                                                                                                                                                                                                                                                                                                                                                                                     |

# SCREEN Menu

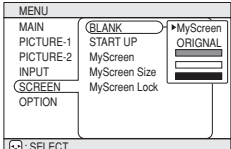

Example : SCREEN Menu (BLANK)

With the SCREEN menu, the five items shown in the Table below can be performed. Please perform each operation in accordance with the instructions in the Table.

## SCREEN Menu

| Item                 | Description                                                                                                                                                                                                                                                                                                                                                                                                                                                                                                                                                                                                                                                                                                                                                                                                                                                                                                                                                                                                                                                                                                                                                                                                                                                                                                                                                                                                                                                                                                                                            |
|----------------------|--------------------------------------------------------------------------------------------------------------------------------------------------------------------------------------------------------------------------------------------------------------------------------------------------------------------------------------------------------------------------------------------------------------------------------------------------------------------------------------------------------------------------------------------------------------------------------------------------------------------------------------------------------------------------------------------------------------------------------------------------------------------------------------------------------------------------------------------------------------------------------------------------------------------------------------------------------------------------------------------------------------------------------------------------------------------------------------------------------------------------------------------------------------------------------------------------------------------------------------------------------------------------------------------------------------------------------------------------------------------------------------------------------------------------------------------------------------------------------------------------------------------------------------------------------|
| <b>BLANK</b>         | <p><b>Selection of BLANK Screen:</b><br/>                     MyScreen (▼) ⇄ (▲) ORIGINAL (▼) ⇄ (▲) [TV icon] (▼) ⇄ (▲) [TV icon] (▼) ⇄ (▲) [TV icon]</p> <p>The BLANK Screen may be voluntarily selected. The BLANK Screen is displayed when the screen has been erased (i.e., made to vanish) by manipulating the BLANK button (please refer to the "Temporarily Blanking the Screen" section of the separate booklet, Vol. 1 (Basic)).</p> <p><b>MyScreen:</b> Using the MyScreen category (see this Table, below), one can register a desired screen (or screens). At the time of factory shipment, this is set as a non-patterned (plain) blue color screen.</p> <p><b>ORIGINAL:</b> Existing standard screens. Please make confirmation using the actual screen(s).</p> <p><b>Option screens:</b> Various colored non-patterned (plain) screens displayed within the Menus.</p> <ul style="list-style-type: none"> <li>The MyScreen and the ORIGINAL Screen will each change to a non-patterned (plain) black color screen several minutes after being displayed.</li> </ul>                                                                                                                                                                                                                                                                                                                                                                                                                                                                     |
| <b>START UP</b>      | <p><b>Selection of START UP Screen:</b><br/>                     MyScreen (▼) ⇄ (▲) ORIGINAL (▼) ⇄ (▲) TURN OFF</p> <p>The START UP Screen may be voluntarily selected. The START UP Screen is displayed when no signal has been inputted, or when spec signals are being inputted.</p> <p><b>MyScreen:</b> Using the MyScreen category (see this Table, below), one can register a desired screen (or screens). At the time of factory shipment, this is set as a non-patterned (plain) blue color screen.</p> <p><b>ORIGINAL:</b> Existing standard screens. Please make confirmation using the actual screen(s).</p> <p><b>TURN OFF:</b> A non-patterned (plain) blue color screen.</p> <ul style="list-style-type: none"> <li>The MyScreen and the ORIGINAL Screen will each change to the BLANK Screen several minutes after being displayed.</li> </ul>                                                                                                                                                                                                                                                                                                                                                                                                                                                                                                                                                                                                                                                                                          |
| <b>MyScreen</b>      | <p><b>Registration of MyScreen:</b><br/>                     When this item is executed, the MyScreen Menu for registration of MyScreen for the BLANK Screen and the START UP Screen is displayed. When operations are performed in accordance with this Menu, one can "cut" and register desired screens from among the received images within the display.</p> <ol style="list-style-type: none"> <li>After the "Do you start capturing this picture?" message has been displayed, pressing the ESC (or RESET) button interrupts execution of the MyScreen. When the ENTER button is pressed, the picture becomes static (no longer moves), and a frame for picture cutting, as well as the message that follows below, appear. Please press the button when the screen you want to register is currently being displayed.</li> <li>When the "Move the capture area as you want." message has been displayed, pressing the ESC (or RESET) button will eliminate the static state of the picture, and operations can be performed again from operation 1. The frame can be moved using the (◀), (▶), (▲), (▼) buttons. After designating the screen you want to register, pressing the ENTER button will initiate screen registration. The registration process takes approximately 1 minute to complete.</li> <li>When the registration has been completed, the screen of the registered MyScreen, plus the message, "MyScreen registration is finished," will be displayed for several seconds, after which the operation is terminated.</li> </ol> |
| <b>MyScreen Size</b> | <p><b>Selection of MyScreen display size:</b><br/>                     x1 (▼) ⇄ (▲) FULL</p>                                                                                                                                                                                                                                                                                                                                                                                                                                                                                                                                                                                                                                                                                                                                                                                                                                                                                                                                                                                                                                                                                                                                                                                                                                                                                                                                                                                                                                                           |
| <b>MyScreen Lock</b> | <p><b>Invalidation of MyScreen registration function:</b><br/>                     TURN ON (▼) ⇄ (▲) TURN OFF</p> <p>When TURN ON is selected, the MyScreen category (see this Table, above) cannot be executed; in this way, one can prohibit rewrites ("writeovers") of the MyScreen.</p>                                                                                                                                                                                                                                                                                                                                                                                                                                                                                                                                                                                                                                                                                                                                                                                                                                                                                                                                                                                                                                                                                                                                                                                                                                                            |

# MULTIFUNCTIONAL SETTINGS (continued)

## OPTION Menu

With the OPTION menu, the five items shown in the Table below can be performed.

Please perform each operation in accordance with the instructions in the Table.

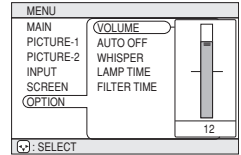

Example : OPTION Menu (VOLUME)

## OPTION Menu

| Item               | Description                                                                                                                                                                                                                                                                                                                                                                                                                                                                                                                                                                                                                                                                                                                                                                                                                                            |
|--------------------|--------------------------------------------------------------------------------------------------------------------------------------------------------------------------------------------------------------------------------------------------------------------------------------------------------------------------------------------------------------------------------------------------------------------------------------------------------------------------------------------------------------------------------------------------------------------------------------------------------------------------------------------------------------------------------------------------------------------------------------------------------------------------------------------------------------------------------------------------------|
| <b>VOLUME</b>      | <b>Adjust Volume:</b> High (▲) ⇔ (▼) Low                                                                                                                                                                                                                                                                                                                                                                                                                                                                                                                                                                                                                                                                                                                                                                                                               |
| <b>AUTO OFF</b>    | <b>Adjust AUTO OFF Time:</b><br>Long (MAX. 99 min.) (▼) ⇔ (▲) Short (Min. 1 min.) (▼) ⇔ (▲) (DISABLE: 0 min.)<br>The system automatically enters the standby mode if no signal is received within the set time. This function is inactive when DISABLE (0 min.) is selected.                                                                                                                                                                                                                                                                                                                                                                                                                                                                                                                                                                           |
| <b>WHISPER</b>     | <b>Select WHISPER Mode:</b><br>NORMAL (▼) ⇔ (▲) WHISPER<br>When WHISPER is selected the WHISPER mode is activated. In the WHISPER mode, acoustic noise and screen brightness are reduced.                                                                                                                                                                                                                                                                                                                                                                                                                                                                                                                                                                                                                                                              |
| <b>LAMP TIME</b>   | <b>Refer to LAMP TIME:</b> When set, this function displays the total time the projector lamp has been used since new.<br><b>Reset LAMP TIME [Use this function only when the lamp has been replaced!]:</b><br>Depress the RESET button for at least 3 seconds while lamp time is being displayed. The reset menu will then appear. After you replace the lamp with a new lamp, select RESET on the menu with the (▲) button. <ul style="list-style-type: none"> <li>Do not reset the lamp time unless you have replaced the lamp. And, always reset the lamp time when replacing the lamp. The message functions will not operate properly if the lamp time is not reset correctly.</li> <li>Before replacing the lamp, carefully read the descriptions headed "THE LAMP".</li> </ul>                                                                 |
| <b>FILTER TIME</b> | <b>Refer to FILTER TIME:</b> This function displays the total time the air-filter has been used since new.<br><b>Reset FILTER TIME [Use this function only when the filter is cleaned or replaced!]:</b><br>Depress the RESET button for at least 3 seconds while lamp time is being displayed. The reset menu will then appear. After you replace the filter, select RESET on the menu with the (▲) button.<br>DEFAULT (▲) ⇔ (▼) CANCEL <ul style="list-style-type: none"> <li>Do not reset the filter time unless you have cleaned or replaced the filter. And, always reset the filter time when cleaning or replacing the filter. The message functions will not operate properly if the filter time is not reset correctly.</li> <li>Before cleaning or replacing the filter, carefully read the descriptions headed "THE AIR FILTER".</li> </ul> |

# WHAT TO DO WHEN YOU THINK A MACHINE DEFECT HAS OCCURRED

## Related Messages

When the unit's power is ON, messages such as those shown below may be displayed. When any such message is displayed on the screen, please respond as described below.

| Message                                                                                                                             | Description                                                                                                                                                                                                                                                                                                                                                                                                        |
|-------------------------------------------------------------------------------------------------------------------------------------|--------------------------------------------------------------------------------------------------------------------------------------------------------------------------------------------------------------------------------------------------------------------------------------------------------------------------------------------------------------------------------------------------------------------|
| <b>CHANGE THE LAMP<br/>AFTER REPLACING LAMP,<br/>RESET THE LAMP TIMER.</b><br>(Note 1)                                              | Lamp usage time is approaching 2,000 hours. (Note 2)<br>Preparation of a new lamp, and an early lamp change, is recommended. After you have changed the lamp, please be sure to reset the lamp timer.                                                                                                                                                                                                              |
| <b>CHANGE THE LAMP<br/>AFTER REPLACING LAMP,<br/>RESET THE LAMP TIMER.<br/>THE POWER WILL TURN OFF<br/>AFTER ** hr.</b><br>(Note 1) | Lamp usage time is approaching 2,000 hours. A lamp change within ** hours is recommended. (Note 2)<br>When lamp usage reaches 2,000 hours, the power will automatically be turned OFF. Please change the lamp by referring to "THE LAMP" in Vol.1 (Basic). After you have changed the lamp, please be sure to reset the lamp timer.                                                                                |
| <b>CHANGE THE LAMP<br/>AFTER REPLACING LAMP,<br/>RESET THE LAMP TIMER.<br/>THE POWER WILL TURN OFF<br/>AFTER 0 hr.</b>              | As lamp use has reached 2,000 hours, the power will soon be automatically turned OFF. (Note 2)<br>Please immediately turn the power OFF, and follow the instructions in the "THE LAMP" section of the separate booklet, Vol.1 (Basic).<br>After you have changed the lamp, please be sure to reset the lamp timer.                                                                                                 |
| <b>CLEAN THE AIR FILTER<br/>AFTER CLEANING AIR FILTER,<br/>RESET THE FILTER TIMER.</b>                                              | A note of precaution when cleaning the air filter.<br>After cleaning the filter, operate FILTER TIME of the OPTION Menu, and perform reset of the filter timer.                                                                                                                                                                                                                                                    |
| <b>NO INPUT IS DETECTED<br/>ON ***</b>                                                                                              | There is no input signal.<br>Please confirm the signal input connection, and the status of the signal source.                                                                                                                                                                                                                                                                                                      |
| <b>SYNC IS OUT OF RANGE</b><br>ON *** <input type="text" value="fh"/> *****kHz <input type="text" value="fv"/> *****Hz              | The horizontal or vertical wavelength of the inputted signal is outside of the response parameters of this unit. Please confirm the specs for this unit or the signal source specs.                                                                                                                                                                                                                                |
| <b>CHECK THE AIR FLOW</b>                                                                                                           | The internal portion temperature is rising. Please turn the power OFF, and allow the unit to cool down for approximately 20 minutes. After having confirmed the following items, then please reset the power to ON. <ul style="list-style-type: none"> <li>• Is there blockage of the air passage aperture?</li> <li>• Is the air filter dirty?</li> <li>• Does the peripheral temperature exceed 35°C?</li> </ul> |

### NOTES

Note 1: Although this message will be automatically disappeared after around 3 minutes, it will be reappeared every time the power is turned ON.

Note 2: Lamps have a finite product life. Lamps are characterized by the fact that, after long hours of usage, a lamp will no longer light up, or the lamp will break or burst, etc. This unit is equipped with an automatic shut-down function, such that the power will automatically be turned OFF when lamp usage time has reached 2,000 hours. Please be aware, however, that among lamp types, there are major differences in product lifetimes; a lamp may thus fail to light even prior to the functioning of the automatic shut-down function of this unit.

## Regarding the Indicator Lamps

Lighting and flashing of the POWER indicator, the LAMP indicator, and the TEMP indicator have the meanings as described in the Table below. Please respond in accordance with the instructions within the Table.

| POWER indicator                    | LAMP indicator                          | TEMP indicator           | Description                                                                                                                                                                                                                                                                                                                                                                                                                                                                                                      |
|------------------------------------|-----------------------------------------|--------------------------|------------------------------------------------------------------------------------------------------------------------------------------------------------------------------------------------------------------------------------------------------------------------------------------------------------------------------------------------------------------------------------------------------------------------------------------------------------------------------------------------------------------|
| The orange lamp is lighted         | Turned OFF (Not lighted)                | Turned OFF (Not lighted) | The STANDBY mode is set                                                                                                                                                                                                                                                                                                                                                                                                                                                                                          |
| Flashing of the green lamp         | Turned OFF                              | Turned OFF               | The unit is warming up. Please wait.                                                                                                                                                                                                                                                                                                                                                                                                                                                                             |
| The green lamp is lighted          | Turned OFF                              | Turned OFF               | The unit is in an ON state. Ordinary operations may be performed.                                                                                                                                                                                                                                                                                                                                                                                                                                                |
| Flashing of the orange lamp        | Turned OFF                              | Turned OFF               | The unit is cooling down. Please wait.                                                                                                                                                                                                                                                                                                                                                                                                                                                                           |
| Blinking of the red lamp           | -                                       | -                        | The unit is cooling down. Please wait.<br>A certain error has been detected. Wait until the POWER indicator lamp has finished flashing, and then perform the proper response measure using the item descriptions below as reference.                                                                                                                                                                                                                                                                             |
| The red lamp is lighted, or blinks | The red lamp is lighted                 | Turned OFF               | The lamp does not light.<br>There is a possibility that the interior portion has become heated. Turn the power OFF and wait approximately 20 minutes. After the main unit has cooled down, please confirm whether or not there is blockage of the air passage aperture, whether or not the filter is dirty, and/or whether or not the peripheral temperature exceeds 35°C, etc. After performing any needed maintenance, turn the power ON again; if the same display is displayed, then please change the lamp. |
| The red lamp is lighted, or blinks | Blinking of the red lamp                | Turned OFF               | Either there is no lamp and/or lamp cover, or either of these has not been properly fixed (attached). Turn the power OFF and wait approximately 45 minutes. After the main unit has sufficiently cooled down, please make confirmation of the attachment state of the lamp and lamp cover. After performing any needed maintenance, turn the power ON again; if the same display is displayed, then please contact a sales store or a service company.                                                           |
| The red lamp is lighted, or blinks | Turned OFF                              | Blinking of the red lamp | The cooling fan is not operating. Turn the power OFF and wait approximately 20 minutes. After the main unit has cooled down, please make confirmation that no foreign matter has become caught in the fan, etc. After performing any needed maintenance, turn the power ON again; if the same display is displayed, then please contact a sales store or a service company.                                                                                                                                      |
| The red lamp is lighted, or blinks | Turned OFF                              | The red lamp is lighted  | There is a possibility that the interior portion has become heated. Turn the power OFF and wait approximately 20 minutes. After the main unit has cooled down, please confirm whether or not there is blockage of the air passage aperture, whether or not the filter is dirty, and/or whether or not the peripheral temperature exceeds 35°C, etc. After performing any needed maintenance, turn the power ON again; if the same display is displayed, then please contact a sales store or a service company.  |
| The green lamp is lighted          | Alternative blinking with the red lamp  |                          | There is a possibility that the interior portion has become overcooled. Please use the unit within the usage temperature parameters (0°C to 35°C). After performing any needed maintenance, turn the power ON again; if the same display is displayed, then please contact a sales store or a service company.                                                                                                                                                                                                   |
| The green lamp is lighted          | Simultaneous blinking with the red lamp |                          | This is a notification that it is time to clean the filter.<br>After cleaning the filter, operate the FILTER TIME portion of the OPTION Menu, and perform reset of the FILTER TIME.                                                                                                                                                                                                                                                                                                                              |

### NOTE

When the interior portion has become overheated, for safety purposes, the power source is automatically turned OFF, and the indicator lamps may also be turned OFF. Press the "○" (power OFF) side of the main power switch, and wait for approximately 20 minutes. Please then use the unit only after having first confirmed that the unit has sufficiently cooled down.



## Phenomena That May Easily Be Mistaken for Machine Defects

Before requesting repair, check in accordance with the following chart.  
If the situation cannot be corrected, then contact your dealer.

| Phenomenon                                               | Cases not involving a machine defect                                                                    | Items to be confirmed                                                                                                                                                                       | Reference Page(s)   |
|----------------------------------------------------------|---------------------------------------------------------------------------------------------------------|---------------------------------------------------------------------------------------------------------------------------------------------------------------------------------------------|---------------------|
| Power does not come ON                                   | The main power source is not ON.                                                                        | Turn on the main power.                                                                                                                                                                     | Vol.1-3, 14         |
|                                                          | The electrical power cord is not plugged in.                                                            | Correctly connect the power cord.                                                                                                                                                           |                     |
|                                                          | The main power source has been interrupted during operation, such as by a power outage (blackout), etc. | Be sure to press the "O" (power OFF) side of the main power switch, and leave this OFF for approximately 20 minutes. After the unit has sufficiently cooled down, turn ON the power source. | Vol.1-14            |
| No sound or pictures are outputted                       | The input changeover settings are mismatched.                                                           | Select the input signal, and correct the settings.                                                                                                                                          | Vol.1-15            |
|                                                          | No signal is being inputted.                                                                            | Correctly connect the connection cord.                                                                                                                                                      | Vol.1-10, 11        |
| Pictures are displayed, but no sounds are heard          | The electrical wiring to this unit is not correctly connected.                                          | Correctly connect the connection cord.                                                                                                                                                      | Vol.1-10, 11        |
|                                                          | The volume setting has been set at (or adjusted to) an extremely low level.                             | Adjust the VOLUME setting to a higher level.                                                                                                                                                | Vol.1-17            |
|                                                          | The MUTE mode is the current setting.                                                                   | Press the MUTE button to release (change) the MUTE mode setting.                                                                                                                            | Vol.1-17            |
| Sounds are heard, but no pictures are displayed          | The electrical wiring to this unit is not correctly connected.                                          | Correctly connect the connection cord.                                                                                                                                                      | Vol.1-10, 11        |
|                                                          | The brightness setting has been set at (or adjusted to) an extremely low level.                         | Adjust the BRIGHT setting to a brighter level.                                                                                                                                              | Vol.2-2             |
|                                                          | The lens cap has not been removed.                                                                      | Remove the lens cap.                                                                                                                                                                        | Vol.1-14            |
| Colors have a faded-out appearance<br>Color tone is poor | Color depth setting or color tone setting                                                               | Perform picture adjustments by changing the COLOR BAL R, the COLOR BAL B, and/or the TINT settings, etc.                                                                                    | Vol.2-3             |
| Pictures appear dark                                     | The brightness setting and/or contrast setting has not been properly adjusted.                          | Perform picture adjustments by changing the BRIGHT and/or CONTRAST settings, etc.                                                                                                           | Vol.2-2             |
|                                                          | The WHISPER mode is the current setting.                                                                | Change (by releasing) from the WHISPER mode.                                                                                                                                                | Vol.2-6             |
|                                                          | Lamp is approaching the end of its product lifetime.                                                    | Exchange the old lamp with a new lamp.                                                                                                                                                      | Vol.1-25, 26        |
| Pictures appear blurry                                   | Either the FOCUS setting or the H PHASE is not properly adjusted.                                       | Adjust the FOCUS and H PHASE settings.                                                                                                                                                      | Vol.1-15<br>Vol.2-3 |

### NOTE

Although bright spots or dark spots may appear on the screen, this is a unique characteristic of liquid crystal displays, and such do not constitute or imply a machine defect.

# SPECIFICATIONS

**NOTE** • This specifications are subject to change without notice.

| Item                    |                         | Specification                                                                                                                                                                                                                                                                                                                                                                                                                                                                                                   |                     |                       |                     |                       |                       |                     |                 |                |                   |                         |                 |                |                         |            |
|-------------------------|-------------------------|-----------------------------------------------------------------------------------------------------------------------------------------------------------------------------------------------------------------------------------------------------------------------------------------------------------------------------------------------------------------------------------------------------------------------------------------------------------------------------------------------------------------|---------------------|-----------------------|---------------------|-----------------------|-----------------------|---------------------|-----------------|----------------|-------------------|-------------------------|-----------------|----------------|-------------------------|------------|
| Product name            |                         | Liquid crystal projector                                                                                                                                                                                                                                                                                                                                                                                                                                                                                        |                     |                       |                     |                       |                       |                     |                 |                |                   |                         |                 |                |                         |            |
| Liquid crystal panel    | Panel size              | 1.8 cm (0.7 type)                                                                                                                                                                                                                                                                                                                                                                                                                                                                                               |                     |                       |                     |                       |                       |                     |                 |                |                   |                         |                 |                |                         |            |
|                         | Drive system            | TFT active matrix                                                                                                                                                                                                                                                                                                                                                                                                                                                                                               |                     |                       |                     |                       |                       |                     |                 |                |                   |                         |                 |                |                         |            |
|                         | Pixels                  | CP-S317 : 480,000 pixels (800 horizontal x600 vertical)<br>CP-X327 : 786,432 pixels (1024 horizontal x 768 vertical)                                                                                                                                                                                                                                                                                                                                                                                            |                     |                       |                     |                       |                       |                     |                 |                |                   |                         |                 |                |                         |            |
| Lens                    |                         | Zoom lens F=1.7 ~ 2.1 f=36.8 ~ 47.8 mm                                                                                                                                                                                                                                                                                                                                                                                                                                                                          |                     |                       |                     |                       |                       |                     |                 |                |                   |                         |                 |                |                         |            |
| Lamp                    |                         | 150 W UHB                                                                                                                                                                                                                                                                                                                                                                                                                                                                                                       |                     |                       |                     |                       |                       |                     |                 |                |                   |                         |                 |                |                         |            |
| Speaker                 |                         | 1.0W                                                                                                                                                                                                                                                                                                                                                                                                                                                                                                            |                     |                       |                     |                       |                       |                     |                 |                |                   |                         |                 |                |                         |            |
| Power supply            |                         | AC100 ~ 120V, 2.7A / AC220 ~ 240V, 1.3A                                                                                                                                                                                                                                                                                                                                                                                                                                                                         |                     |                       |                     |                       |                       |                     |                 |                |                   |                         |                 |                |                         |            |
| Power consumption       |                         | 240W                                                                                                                                                                                                                                                                                                                                                                                                                                                                                                            |                     |                       |                     |                       |                       |                     |                 |                |                   |                         |                 |                |                         |            |
| Temperature range       |                         | 0 ~ 35°C (Operating)                                                                                                                                                                                                                                                                                                                                                                                                                                                                                            |                     |                       |                     |                       |                       |                     |                 |                |                   |                         |                 |                |                         |            |
| Size                    |                         | 295 (W) x 87.5 (H) x237 (D) mm                                                                                                                                                                                                                                                                                                                                                                                                                                                                                  |                     |                       |                     |                       |                       |                     |                 |                |                   |                         |                 |                |                         |            |
| Weight (mass)           |                         | 2.7 kg                                                                                                                                                                                                                                                                                                                                                                                                                                                                                                          |                     |                       |                     |                       |                       |                     |                 |                |                   |                         |                 |                |                         |            |
| Terminal                |                         | <table border="0"> <tr> <td><b>RGB Terminal</b></td> <td><b>AUDIO Terminal</b></td> </tr> <tr> <td>RGB IN(1, 2) .....2</td> <td>AUDIO IN(R, L) .....1</td> </tr> <tr> <td><b>VIDEO Terminal</b></td> <td><b>OUT Terminal</b></td> </tr> <tr> <td>VIDEO IN .....1</td> <td>RGB OUT .....1</td> </tr> <tr> <td>S-VIDEO IN .....1</td> <td><b>CONTROL Terminal</b></td> </tr> <tr> <td>COMPONENT VIDEO</td> <td>CONTROL .....1</td> </tr> <tr> <td>(Y, Cb/Pb,Cr/Pr) .....1</td> <td>USB .....1</td> </tr> </table> | <b>RGB Terminal</b> | <b>AUDIO Terminal</b> | RGB IN(1, 2) .....2 | AUDIO IN(R, L) .....1 | <b>VIDEO Terminal</b> | <b>OUT Terminal</b> | VIDEO IN .....1 | RGB OUT .....1 | S-VIDEO IN .....1 | <b>CONTROL Terminal</b> | COMPONENT VIDEO | CONTROL .....1 | (Y, Cb/Pb,Cr/Pr) .....1 | USB .....1 |
| <b>RGB Terminal</b>     | <b>AUDIO Terminal</b>   |                                                                                                                                                                                                                                                                                                                                                                                                                                                                                                                 |                     |                       |                     |                       |                       |                     |                 |                |                   |                         |                 |                |                         |            |
| RGB IN(1, 2) .....2     | AUDIO IN(R, L) .....1   |                                                                                                                                                                                                                                                                                                                                                                                                                                                                                                                 |                     |                       |                     |                       |                       |                     |                 |                |                   |                         |                 |                |                         |            |
| <b>VIDEO Terminal</b>   | <b>OUT Terminal</b>     |                                                                                                                                                                                                                                                                                                                                                                                                                                                                                                                 |                     |                       |                     |                       |                       |                     |                 |                |                   |                         |                 |                |                         |            |
| VIDEO IN .....1         | RGB OUT .....1          |                                                                                                                                                                                                                                                                                                                                                                                                                                                                                                                 |                     |                       |                     |                       |                       |                     |                 |                |                   |                         |                 |                |                         |            |
| S-VIDEO IN .....1       | <b>CONTROL Terminal</b> |                                                                                                                                                                                                                                                                                                                                                                                                                                                                                                                 |                     |                       |                     |                       |                       |                     |                 |                |                   |                         |                 |                |                         |            |
| COMPONENT VIDEO         | CONTROL .....1          |                                                                                                                                                                                                                                                                                                                                                                                                                                                                                                                 |                     |                       |                     |                       |                       |                     |                 |                |                   |                         |                 |                |                         |            |
| (Y, Cb/Pb,Cr/Pr) .....1 | USB .....1              |                                                                                                                                                                                                                                                                                                                                                                                                                                                                                                                 |                     |                       |                     |                       |                       |                     |                 |                |                   |                         |                 |                |                         |            |
| Optional Parts          |                         | Lamp: CP-S317=DT00511, CP-X327=DT00521<br>Air Filter: MU01691<br>* For others, consult your dealer.                                                                                                                                                                                                                                                                                                                                                                                                             |                     |                       |                     |                       |                       |                     |                 |                |                   |                         |                 |                |                         |            |

## Dimension Diagram

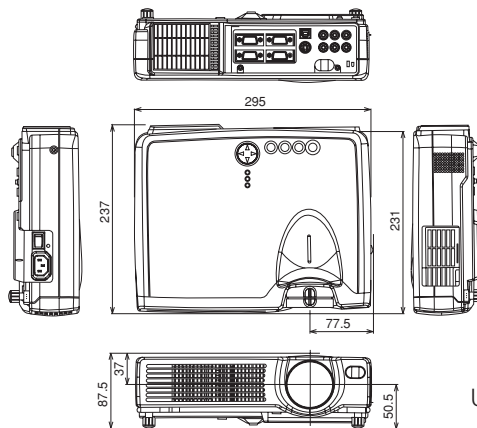

Unit : mm

## WARRANTY AND AFTER-SERVICE

If a problem occurs with the equipment, first refer to the **7** “WHAT TO DO WHEN YOU THINK A MACHINE DEFECT HAS OCCURRED” section and run through the suggested checks. If this does not resolve the problem contact your dealer or service company. They will tell you what warranty condition is applied.

# TECHNICAL

## SIGNAL CONNECTOR PIN ASSIGNMENT

RGB IN [1]/[2]  
RGB OUT



D-sub 15-pin Shrink

S-VIDEO

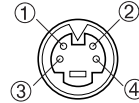

Mini Din 4-pin

| Pin No | Signal            | Pin No | Signal                    |
|--------|-------------------|--------|---------------------------|
| 1      | Video input Red   | 9      | -                         |
| 2      | Video input Green | 10     | Ground                    |
| 3      | Video input Blue  | 11     | -                         |
| 4      | -                 | 12     | RGB IN [1]: SDA (DDC)     |
| 5      | Ground            |        | RGB IN [2]: -             |
| 6      | Ground Red        |        | RGB OUT : -               |
| 7      | Ground Green      | 13     | H. sync./ Composite sync. |
| 8      | Ground Blue       | 14     | Vertical sync             |
|        |                   | 15     | RGB IN [1]: SCL (DDC)     |
|        |                   |        | RGB IN [2]: -             |
|        |                   |        | RGB OUT : -               |

| Mini Din 4-pin |                                                                                                                     |
|----------------|---------------------------------------------------------------------------------------------------------------------|
| Pin No         | Signal                                                                                                              |
| 1              | Color:<br>0.286Vp-p (NTSC, burst signal),<br>75Ω terminator<br>0.3Vp-p (PAL/SECAM, burst signal),<br>75Ω terminator |
| 2              | Brightness:<br>1.0Vp-p, 75Ω terminator                                                                              |
| 3              | Ground                                                                                                              |
| 4              | Ground                                                                                                              |

| signal             | Terminal        | Specification                                                                                                                                                 |                                                                                                                                                                                          |
|--------------------|-----------------|---------------------------------------------------------------------------------------------------------------------------------------------------------------|------------------------------------------------------------------------------------------------------------------------------------------------------------------------------------------|
| RGB signal input   | RGB IN (1, 2)   | Video: Analog 0.7Vp-p, 75Ω terminator (positive)<br>H/V. sync.: TTL level (positive/negative)<br>Composite sync.: TTL level<br>D-sub 15-pin shrink jack       |                                                                                                                                                                                          |
| Video signal input | VIDEO IN        | 1.0Vp-p, 75Ω terminator, RCA jack                                                                                                                             |                                                                                                                                                                                          |
|                    | COMPONENT VIDEO | S-VIDEO IN                                                                                                                                                    | Brightness signal: 1.0Vp-p, 75Ω terminator<br>Color signal: 0.286Vp-p (NTSC, burst signal), 75Ω terminator<br>0.300Vp-p (PAL/SECAM, burst signal), 75Ω terminator<br>Mini DIN 4-pin jack |
|                    |                 | Y                                                                                                                                                             | 1.0 Vp-p, 75 Ω Terminator (Positive)                                                                                                                                                     |
|                    |                 | Cb/Pb                                                                                                                                                         | 0.7 Vp-p, 75 Ω Terminator (Positive)                                                                                                                                                     |
|                    | Cr/Pr           | 0.7 Vp-p, 75 Ω Terminator (Positive)                                                                                                                          |                                                                                                                                                                                          |
| Audio signal input | AUDIO IN (R, L) | 200mVrms, 50 kΩ (max. 3.0Vp-p)<br>RCA jack                                                                                                                    |                                                                                                                                                                                          |
| Signal output      | RGB OUT         | Video: Analog 0.7Vp-p, 75Ω output impedance (positive)<br>H/V. sync.: TTL level (positive/negative)<br>Composite sync.: TTL level<br>D-sub 15-pin shrink jack |                                                                                                                                                                                          |

## EXAMPLE OF COMPUTER SIGNAL

| Resolution<br>H × V | fH (kHz) | fV (Hz) | Rating | Signal mode | Display mode |          |
|---------------------|----------|---------|--------|-------------|--------------|----------|
|                     |          |         |        |             | CP-S317      | CP-X327  |
| 720 × 400           | 37.9     | 85.0    | VESA   | TEXT        | Zoom in      | Zoom in  |
| 640 × 480           | 31.5     | 59.9    | VESA   | VGA (60Hz)  | Zoom in      | Zoom in  |
| 640 × 480           | 35.0     | 66.7    |        | Mac13"mode  | Zoom in      | Zoom in  |
| 640 × 480           | 37.9     | 72.8    | VESA   | VGA (72Hz)  | Zoom in      | Zoom in  |
| 640 × 480           | 37.5     | 75.0    | VESA   | VGA (75Hz)  | Zoom in      | Zoom in  |
| 640 × 480           | 43.3     | 85.0    | VESA   | VGA (85Hz)  | Zoom in      | Zoom in  |
| 800 × 600           | 35.2     | 56.3    | VESA   | SVGA (56Hz) |              | Zoom in  |
| 800 × 600           | 37.9     | 60.3    | VESA   | SVGA (60Hz) |              | Zoom in  |
| 800 × 600           | 48.1     | 72.2    | VESA   | SVGA (72Hz) |              | Zoom in  |
| 800 × 600           | 46.9     | 75.0    | VESA   | SVGA (75Hz) |              | Zoom in  |
| 800 × 600           | 53.7     | 85.1    | VESA   | SVGA (85Hz) |              | Zoom in  |
| 832 × 624           | 49.7     | 74.5    |        | Mac16"mode  | Zoom out     | Zoom in  |
| 1024 × 768          | 48.4     | 60.0    | VESA   | XGA (60Hz)  | Zoom out     |          |
| 1024 × 768          | 56.5     | 70.1    | VESA   | XGA (70Hz)  | Zoom out     |          |
| 1024 × 768          | 60.0     | 75.0    | VESA   | XGA (75Hz)  | Zoom out     |          |
| 1024 × 768          | 68.7     | 85.0    | VESA   | XGA (85Hz)  | Zoom out     |          |
| 1152 × 864          | 67.5     | 75.0    | VESA   | SXGA (75Hz) | Zoom out     | Zoom out |
| 1280 × 960          | 60.0     | 60.0    | VESA   | SXGA (60Hz) | Zoom out     | Zoom out |
| 1280 × 1024         | 64.0     | 60.0    | VESA   | SXGA (60Hz) | Zoom out     | Zoom out |
| 1280 × 1024         | 80.0     | 75.0    | VESA   | SXGA (75Hz) | Zoom out     | Zoom out |
| 1280 × 1024         | 91.2     | 85.0    | VESA   | SXGA (85Hz) | Zoom out     | Zoom out |
| 1600 × 1200         | 75.0     | 60.0    | VESA   | UXGA (60Hz) | Zoom out     | Zoom out |

- NOTE** • Some computers may have multiple display screen modes. Use of some of these modes will not be possible with this projector.
- Be sure to check jack type, signal level, timing and resolution before connecting this projector to a computer.
  - Depending on the input signal, full-size display may not be possible in some cases. Refer to the number of display pixels above.
  - This projector will display up to UXGA (1600X1200) resolution signals but the image will be rescaled to the native resolution of the projector. Best display performance is achieved when the signal input resolution is the same as the native resolution of the projector.
  - The image may not be displayed correctly when the input sync. signal is "Composite Sync." or "Sync. on G".

# INITIAL SET SIGNALS

The following signals are used for the initial settings.

The signal timing of some computer models may be different. In such case, refer to adjust the V.POSIT and H.POSIT of the menu.

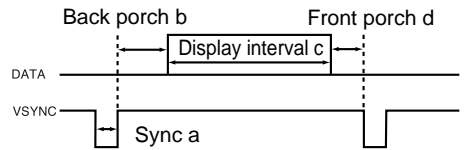
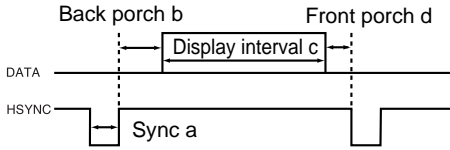

| Computer / Signal | Horizontal signal timing (μs) |     |      |     |
|-------------------|-------------------------------|-----|------|-----|
|                   | a                             | b   | c    | d   |
| TEXT              | 2.0                           | 3.0 | 20.3 | 1.0 |
| VGA (60Hz)        | 3.8                           | 1.9 | 25.4 | 0.6 |
| Mac 13"mode       | 2.1                           | 3.2 | 21.2 | 2.1 |
| VGA (72Hz)        | 1.3                           | 3.8 | 20.3 | 1.0 |
| VGA (75Hz)        | 2.0                           | 3.8 | 20.3 | 0.5 |
| VGA (85Hz)        | 1.6                           | 2.2 | 17.8 | 1.6 |
| SVGA (56Hz)       | 2.0                           | 3.6 | 22.2 | 0.7 |
| SVGA (60Hz)       | 3.2                           | 2.2 | 20.0 | 1.0 |
| SVGA (72Hz)       | 2.4                           | 1.3 | 16.0 | 1.1 |
| SVGA (75Hz)       | 1.6                           | 3.2 | 16.2 | 0.3 |
| SVGA (85Hz)       | 1.1                           | 2.7 | 14.2 | 0.6 |
| Mac 16"mode       | 1.1                           | 3.9 | 14.5 | 0.6 |
| XGA (60Hz)        | 2.1                           | 2.5 | 15.8 | 0.4 |
| XGA (70Hz)        | 1.8                           | 1.9 | 13.7 | 0.3 |
| XGA (75Hz)        | 1.2                           | 2.2 | 13.0 | 0.2 |
| XGA (85Hz)        | 1.0                           | 2.2 | 10.8 | 0.5 |
| 1152x864 (75Hz)   | 1.2                           | 2.4 | 10.7 | 0.6 |
| 1280x960 (60Hz)   | 1.0                           | 2.9 | 11.9 | 0.9 |
| 1280x1024 (60Hz)  | 1.0                           | 2.3 | 11.9 | 0.4 |
| 1280x1024 (75Hz)  | 1.1                           | 1.8 | 9.5  | 0.2 |
| 1280x1024 (85Hz)  | 1.0                           | 1.4 | 8.1  | 0.4 |
| 1600x1200 (60Hz)  | 1.2                           | 1.9 | 9.9  | 0.4 |

| Computer / Signal | Vertical signal timing (lines) |    |      |    |
|-------------------|--------------------------------|----|------|----|
|                   | a                              | b  | c    | d  |
| TEXT              | 3                              | 42 | 400  | 1  |
| VGA (60Hz)        | 2                              | 33 | 480  | 10 |
| Mac 13"mode       | 3                              | 39 | 480  | 3  |
| VGA (72Hz)        | 3                              | 28 | 480  | 9  |
| VGA (75Hz)        | 3                              | 16 | 480  | 1  |
| VGA (85Hz)        | 3                              | 25 | 480  | 1  |
| SVGA (56Hz)       | 2                              | 22 | 600  | 1  |
| SVGA (60Hz)       | 4                              | 23 | 600  | 1  |
| SVGA (72Hz)       | 6                              | 23 | 600  | 37 |
| SVGA (75Hz)       | 3                              | 21 | 600  | 1  |
| SVGA (85Hz)       | 3                              | 27 | 600  | 1  |
| Mac 16"mode       | 3                              | 39 | 624  | 1  |
| XGA (60Hz)        | 6                              | 29 | 768  | 3  |
| XGA (70Hz)        | 6                              | 29 | 768  | 3  |
| XGA (75Hz)        | 3                              | 28 | 768  | 1  |
| XGA (85Hz)        | 3                              | 36 | 768  | 1  |
| 1152x864 (75Hz)   | 3                              | 32 | 864  | 1  |
| 1280x960 (60Hz)   | 3                              | 36 | 960  | 1  |
| 1280x1024 (60Hz)  | 3                              | 38 | 1024 | 1  |
| 1280x1024 (75Hz)  | 3                              | 37 | 1024 | 2  |
| 1280x1024 (85Hz)  | 3                              | 44 | 1024 | 1  |
| 1600x1200 (60Hz)  | 3                              | 46 | 1200 | 1  |

# CONNECTION TO THE MOUSE CONTROL

## ADB Mouse

CONTROL Terminal  
D-sub 15-pin shrink jack

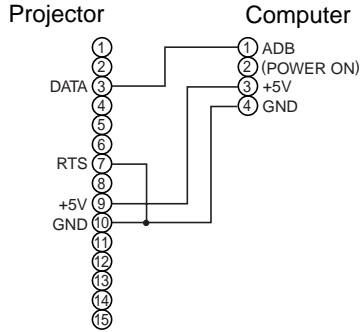

Mouse jack  
Mini DIN 4-pin



## Serial Mouse

CONTROL Terminal  
D-sub 15-pin shrink jack

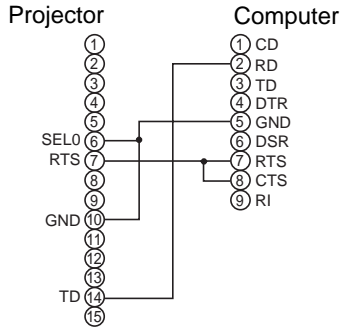
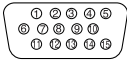

Mouse jack  
D-sub 9-pin

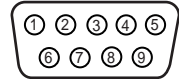

## USB Mouse

USB jack  
(B type)

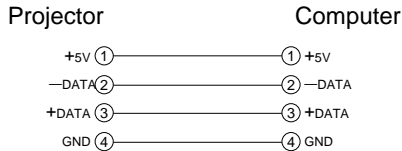

USB cable

USB jack  
(A type)



## PS/2 Mouse

CONTROL Terminal  
D-sub 15-pin shrink jack

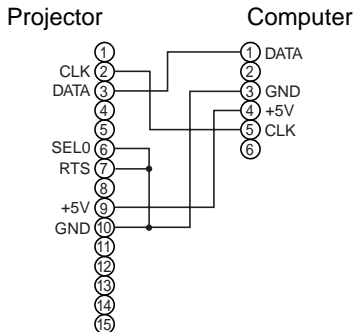
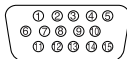

Mouse jack  
Mini DIN 6-pin

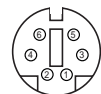

# RS-232C COMMUNICATION

- (1) Turn off the projector and computer power supplies and connect with the RS-232C cable.
- (2) Turn on the computer power supply and after the computer has started up, turn on the projector power supply.

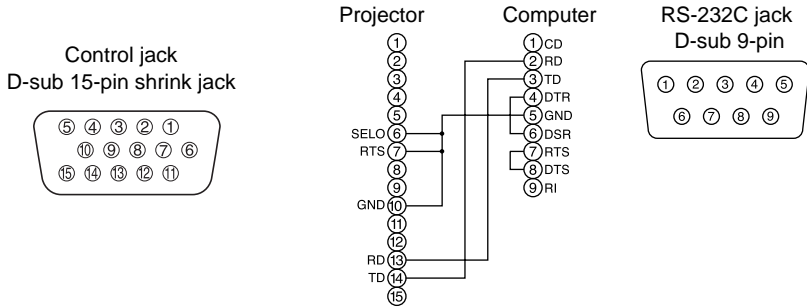

## Communications setting

19200bps, 8N1

### 1 Protocol

Consist of header (7 bytes) + command data (6 bytes).

### 2 Header

BE + EF + 03 + 06 + 00 + CRC\_low + CRC\_high

CRC\_low : Lower byte of CRC flag for command data.

CRC\_high : Upper byte of CRC flag for command data.

### 3 Command data

Command data chart

| byte_0 | byte_1 | byte_2 | byte_3 | byte_4       | byte_5 |
|--------|--------|--------|--------|--------------|--------|
| Action |        | Type   |        | Setting code |        |
| low    | high   | low    | high   | low          | high   |

Action (byte\_0 - 1)

| Action | Classification | Content                              |
|--------|----------------|--------------------------------------|
| 1      | SET            | Change setting to desired value.     |
| 2      | GET            | Read projector internal setup value. |
| 4      | INCREMENT      | Increment setup value by 1.          |
| 5      | DECREMENT      | Decrement setup value by 1.          |
| 6      | EXECUTE        | Run a command.                       |



# RS-232C COMMUNICATION (continued)

## Requesting projector status (Get command)

- (1) Send the request code Header + Command data ('02H'+ '00H'+ type (2 bytes) + '00H'+ '00H') from the computer to the projector.
- (2) The projector returns the response code '1DH'+ data (2 bytes) to the computer.

## Changing the projector settings (Set command)

- (1) Send the setting code Header + Command data ('01H'+ '00H'+ type (2 bytes) + setting code (2 bytes)) from the computer to the projector.
- (2) The projector changes the setting based on the above setting code.
- (3) The projector returns the response code '06H' to the computer.

## Using the projector default settings (Reset Command)

- (1) The computer sends the default setting code Header + Command data ('06H'+ '00H'+ type (2 bytes) + '00H'+ '00H') to the projector.
- (2) The projector changes the specified setting to the default value.
- (3) The projector returns the response code '06H' to the computer.

## Increasing the projector setting value (Increment command)

- (1) The computer sends the increment code Header + Command data ('04H'+ '00H'+ type (2 bytes) + '00H'+ '00H') to the projector.
- (2) The projector increases the setting value on the above setting code.
- (3) The projector returns the response code '06H' to the computer.

## Decreasing the projector setting value (Decrement command)

- (1) The computer sends the decrement code Header + Command data ('05H'+ '00H'+ type (2 bytes) + '00H'+ '00H') to the projector.
- (2) The projector decreases the setting value on the above setting code.
- (3) The projector returns the response code '06H' to the computer.

## When a command sent by the projector cannot be understood by the computer

When the command sent by the projector cannot be understood, the error command '15H' is returned by the computer. Some times, the projector ignores RS-232C commands during other works. If the error command '15H' is returned, please send the same command again.

## When data sent by the projector cannot be practice

When the command sent by the projector cannot be practiced, the the error code '1cH' + 'xxxxH' is returned.

When the data length is greater than indicated by the data length code, the projector will ignore the excess data code.

Conversely, when the data length is shorter than indicated by the data length code, an error code will be returned to the projector.

- NOTE**
- Operation cannot be guaranteed when the projector receives an undefined command or data.
  - Provide an interval of at least 40ms between the response code and any other code.
  - The projector outputs test data when the power supply is switched ON, and when the lamp is lit. Ignore this data.
  - Commands are not accepted during warm-up.

# Command data chart

| Names            | Operation type | Header     |    |    |     | Command data |      |              |    |    |    |    |    |    |    |
|------------------|----------------|------------|----|----|-----|--------------|------|--------------|----|----|----|----|----|----|----|
|                  |                |            |    |    | CRC | Action       | Type | Setting code |    |    |    |    |    |    |    |
| Blank Color      | Set            | Blue       | BE | EF | 03  | 06           | 00   | CB           | D3 | 01 | 00 | 00 | 30 | 03 | 00 |
|                  |                | White      | BE | EF | 03  | 06           | 00   | 6B           | D0 | 01 | 00 | 00 | 30 | 05 | 00 |
|                  |                | Black      | BE | EF | 03  | 06           | 00   | 9B           | D0 | 01 | 00 | 00 | 30 | 06 | 00 |
|                  |                | MyScreen   | BE | EF | 03  | 06           | 00   | FB           | CA | 01 | 00 | 00 | 30 | 20 | 00 |
|                  | ORIGNAL        | BE         | EF | 03 | 06  | 00           | FB   | E2           | 01 | 00 | 00 | 30 | 40 | 00 |    |
|                  | Get            | BE         | EF | 03 | 06  | 00           | 08   | D3           | 02 | 00 | 00 | 30 | 00 | 00 |    |
| Mirror           | Set            | Normal     | BE | EF | 03  | 06           | 00   | C7           | D2 | 01 | 00 | 01 | 30 | 00 | 00 |
|                  |                | H Inverse  | BE | EF | 03  | 06           | 00   | 57           | D3 | 01 | 00 | 01 | 30 | 01 | 00 |
|                  |                | V Inverse  | BE | EF | 03  | 06           | 00   | A7           | D3 | 01 | 00 | 01 | 30 | 02 | 00 |
|                  | H&V Inverse    | BE         | EF | 03 | 06  | 00           | 37   | D2           | 01 | 00 | 01 | 30 | 03 | 00 |    |
|                  | Get            | BE         | EF | 03 | 06  | 00           | F4   | D2           | 02 | 00 | 01 | 30 | 00 | 00 |    |
| Freeze           | Set            | Normal     | BE | EF | 03  | 06           | 00   | 83           | D2 | 01 | 00 | 02 | 30 | 00 | 00 |
|                  |                | Freeze     | BE | EF | 03  | 06           | 00   | 13           | D3 | 01 | 00 | 02 | 30 | 01 | 00 |
|                  | Get            | BE         | EF | 03 | 06  | 00           | B0   | D2           | 02 | 00 | 02 | 30 | 00 | 00 |    |
| Startup          | Set            | ORIGNAL    | BE | EF | 03  | 06           | 00   | 0B           | D2 | 01 | 00 | 04 | 30 | 00 | 00 |
|                  |                | OFF        | BE | EF | 03  | 06           | 00   | 9B           | D3 | 01 | 00 | 04 | 30 | 01 | 00 |
|                  |                | MyScreen   | BE | EF | 03  | 06           | 00   | CB           | CB | 01 | 00 | 04 | 30 | 20 | 00 |
|                  | Get            | BE         | EF | 03 | 06  | 00           | 38   | D2           | 02 | 00 | 04 | 30 | 00 | 00 |    |
| Language         | Set            | English    | BE | EF | 03  | 06           | 00   | F7           | D3 | 01 | 00 | 05 | 30 | 00 | 00 |
|                  |                | Français   | BE | EF | 03  | 06           | 00   | 67           | D2 | 01 | 00 | 05 | 30 | 01 | 00 |
|                  |                | Deutsch    | BE | EF | 03  | 06           | 00   | 97           | D2 | 01 | 00 | 05 | 30 | 02 | 00 |
|                  |                | Español    | BE | EF | 03  | 06           | 00   | 07           | D3 | 01 | 00 | 05 | 30 | 03 | 00 |
|                  |                | Italiano   | BE | EF | 03  | 06           | 00   | 37           | D1 | 01 | 00 | 05 | 30 | 04 | 00 |
|                  |                | Norsk      | BE | EF | 03  | 06           | 00   | A7           | D0 | 01 | 00 | 05 | 30 | 05 | 00 |
|                  |                | Nederlands | BE | EF | 03  | 06           | 00   | 57           | D0 | 01 | 00 | 05 | 30 | 06 | 00 |
|                  |                | Português  | BE | EF | 03  | 06           | 00   | C7           | D1 | 01 | 00 | 05 | 30 | 07 | 00 |
|                  |                | 日本語        | BE | EF | 03  | 06           | 00   | 37           | D4 | 01 | 00 | 05 | 30 | 08 | 00 |
|                  | 中文             | BE         | EF | 03 | 06  | 00           | A7   | D5           | 01 | 00 | 05 | 30 | 09 | 00 |    |
| 한글               | BE             | EF         | 03 | 06 | 00  | 57           | D5   | 01           | 00 | 05 | 30 | 0A | 00 |    |    |
|                  | Get            | BE         | EF | 03 | 06  | 00           | C4   | D3           | 02 | 00 | 05 | 30 | 00 | 00 |    |
| Magnify          | Get            | BE         | EF | 03 | 06  | 00           | 7C   | D2           | 02 | 00 | 07 | 30 | 00 | 00 |    |
|                  | Increment      | BE         | EF | 03 | 06  | 00           | 1A   | D2           | 04 | 00 | 07 | 30 | 00 | 00 |    |
|                  | Decrement      | BE         | EF | 03 | 06  | 00           | CB   | D3           | 05 | 00 | 07 | 30 | 00 | 00 |    |
| Auto off         | Get            | BE         | EF | 03 | 06  | 00           | 08   | 86           | 02 | 00 | 10 | 31 | 00 | 00 |    |
|                  | Increment      | BE         | EF | 03 | 06  | 00           | 6E   | 86           | 04 | 00 | 10 | 31 | 00 | 00 |    |
|                  | Decrement      | BE         | EF | 03 | 06  | 00           | BF   | 87           | 05 | 00 | 10 | 31 | 00 | 00 |    |
| Brightness Reset | Execute        | BE         | EF | 03 | 06  | 00           | 58   | D3           | 06 | 00 | 00 | 70 | 00 | 00 |    |
| Contrast Reset   | Execute        | BE         | EF | 03 | 06  | 00           | A4   | D2           | 06 | 00 | 01 | 70 | 00 | 00 |    |
| V.Position Reset | Execute        | BE         | EF | 03 | 06  | 00           | E0   | D2           | 06 | 00 | 02 | 70 | 00 | 00 |    |

## Command data chart (continued)

| Names                 | Operation type |                                                                                                                                                                                                                                      | Header |          |          | Command data |        |       |              |
|-----------------------|----------------|--------------------------------------------------------------------------------------------------------------------------------------------------------------------------------------------------------------------------------------|--------|----------|----------|--------------|--------|-------|--------------|
|                       |                |                                                                                                                                                                                                                                      |        |          |          | CRC          | Action | Type  | Setting code |
| H.Position Reset      | Execute        |                                                                                                                                                                                                                                      | BE EF  | 03 06    | 00 IC D3 | 06 00        | 03 70  | 00 00 |              |
| H.Size Reset          | Execute        |                                                                                                                                                                                                                                      | BE EF  | 03 06    | 00 68 D2 | 06 00        | 04 70  | 00 00 |              |
| Color Balance R Reset | Execute        |                                                                                                                                                                                                                                      | BE EF  | 03 06    | 00 94 D3 | 06 00        | 05 70  | 00 00 |              |
| Color Balance B Reset | Execute        |                                                                                                                                                                                                                                      | BE EF  | 03 06    | 00 D0 D3 | 06 00        | 06 70  | 00 00 |              |
| Sharpness Reset       | Execute        |                                                                                                                                                                                                                                      | BE EF  | 03 06    | 00 C4 D0 | 06 00        | 09 70  | 00 00 |              |
| Color Reset           | Execute        |                                                                                                                                                                                                                                      | BE EF  | 03 06    | 00 80 D0 | 06 00        | 0A 70  | 00 00 |              |
| Tint Reset            | Execute        |                                                                                                                                                                                                                                      | BE EF  | 03 06    | 00 7C D1 | 06 00        | 0B 70  | 00 00 |              |
| Keystone_V Reset      | Execute        |                                                                                                                                                                                                                                      | BE EF  | 03 06    | 00 08 D0 | 06 00        | 0C 70  | 00 00 |              |
| Keystone_H Reset      | Execute        |                                                                                                                                                                                                                                      | BE EF  | 03 06    | 00 98 D8 | 06 00        | 20 70  | 00 00 |              |
| Auto Adjust           | Execute        |                                                                                                                                                                                                                                      | BE EF  | 03 06    | 00 91 D0 | 06 00        | 0A 20  | 00 00 |              |
| Lamp Time Reset       | Execute        |                                                                                                                                                                                                                                      | BE EF  | 03 06    | 00 58 DC | 06 00        | 30 70  | 00 00 |              |
| Filter Time Reset     | Execute        |                                                                                                                                                                                                                                      | BE EF  | 03 06    | 00 98 C6 | 06 00        | 40 70  | 00 00 |              |
| Blank on/off          | Set            | off                                                                                                                                                                                                                                  | BE EF  | 03 06    | 00 FB D8 | 01 00        | 20 30  | 00 00 |              |
|                       |                | on                                                                                                                                                                                                                                   | BE EF  | 03 06    | 00 6B D9 | 01 00        | 20 30  | 01 00 |              |
|                       | Get            | BE EF                                                                                                                                                                                                                                | 03 06  | 00 C8 D8 | 02 00    | 20 30        | 00 00  |       |              |
| Error Status          | Get            |                                                                                                                                                                                                                                      | BE EF  | 03 06    | 00 D9 D8 | 02 00        | 20 60  | 00 00 |              |
|                       |                | (Example of Return)<br>00 00    01 00    02 00    03 00<br>(Normal) (Cover-error) (Fan-error) (Lamp-error)<br>04 00    05 00    06 00    07 00    0800<br>(Temp-error) (Air flow-error) (Lamp-Time-over) (Cool-error) (Filter-Error) |        |          |          |              |        |       |              |
| Power                 | Set            | OFF                                                                                                                                                                                                                                  | BE EF  | 03 06    | 00 2A D3 | 01 00        | 00 60  | 00 00 |              |
|                       |                | ON                                                                                                                                                                                                                                   | BE EF  | 03 06    | 00 BA D2 | 01 00        | 00 60  | 01 00 |              |
|                       | Get            | BE EF                                                                                                                                                                                                                                | 03 06  | 00 19 D3 | 02 00    | 00 60        | 00 00  |       |              |
| Input Source          | Set            | RGB1                                                                                                                                                                                                                                 | BE EF  | 03 06    | 00 FE D2 | 01 00        | 00 20  | 00 00 |              |
|                       |                | RGB2                                                                                                                                                                                                                                 | BE EF  | 03 06    | 00 3E D0 | 01 00        | 00 20  | 04 00 |              |
|                       |                | Video                                                                                                                                                                                                                                | BE EF  | 03 06    | 00 6E D3 | 01 00        | 00 20  | 01 00 |              |
|                       |                | SVideo                                                                                                                                                                                                                               | BE EF  | 03 06    | 00 9E D3 | 01 00        | 00 20  | 02 00 |              |
|                       |                | Component                                                                                                                                                                                                                            | BE EF  | 03 06    | 00 AE D1 | 01 00        | 00 20  | 05 00 |              |
|                       | Get            | BE EF                                                                                                                                                                                                                                | 03 06  | 00 CD D2 | 02 00    | 00 20        | 00 00  |       |              |
| Volume                | Get            |                                                                                                                                                                                                                                      | BE EF  | 03 06    | 00 31 D3 | 02 00        | 01 20  | 00 00 |              |
|                       | Increment      |                                                                                                                                                                                                                                      | BE EF  | 03 06    | 00 57 D3 | 04 00        | 01 20  | 00 00 |              |
|                       | Decrement      |                                                                                                                                                                                                                                      | BE EF  | 03 06    | 00 86 D2 | 05 00        | 01 20  | 00 00 |              |
| Mute                  | Set            | Normal                                                                                                                                                                                                                               | BE EF  | 03 06    | 00 46 D3 | 01 00        | 02 20  | 00 00 |              |
|                       |                | Mute                                                                                                                                                                                                                                 | BE EF  | 03 06    | 00 D6 D2 | 01 00        | 02 20  | 01 00 |              |
|                       | Get            | BE EF                                                                                                                                                                                                                                | 03 06  | 00 75 D3 | 02 00    | 02 20        | 00 00  |       |              |
| Brightness            | Get            |                                                                                                                                                                                                                                      | BE EF  | 03 06    | 00 89 D2 | 02 00        | 03 20  | 00 00 |              |
|                       | Increment      |                                                                                                                                                                                                                                      | BE EF  | 03 06    | 00 EF D2 | 04 00        | 03 20  | 00 00 |              |
|                       | Decrement      |                                                                                                                                                                                                                                      | BE EF  | 03 06    | 00 3E D3 | 05 00        | 03 20  | 00 00 |              |

| Names                               | Operation type |         | Header |          |       | Command data |        |       |              |
|-------------------------------------|----------------|---------|--------|----------|-------|--------------|--------|-------|--------------|
|                                     |                |         |        |          |       | CRC          | Action | Type  | Setting code |
| Contrast                            | Get            |         | BE EF  | 03 06 00 | FD D3 | 02 00        | 04 20  | 00 00 |              |
|                                     | Increment      |         | BE EF  | 03 06 00 | 9B D3 | 04 00        | 04 20  | 00 00 |              |
|                                     | Decrement      |         | BE EF  | 03 06 00 | 4A D2 | 05 00        | 04 20  | 00 00 |              |
| Color Balance R                     | Get            |         | BE EF  | 03 06 00 | 01 D2 | 02 00        | 05 20  | 00 00 |              |
|                                     | Increment      |         | BE EF  | 03 06 00 | 67 D2 | 04 00        | 05 20  | 00 00 |              |
|                                     | Decrement      |         | BE EF  | 03 06 00 | B6 D3 | 05 00        | 05 20  | 00 00 |              |
| Color Balance B                     | Get            |         | BE EF  | 03 06 00 | 45 D2 | 02 00        | 06 20  | 00 00 |              |
|                                     | Increment      |         | BE EF  | 03 06 00 | 23 D2 | 04 00        | 06 20  | 00 00 |              |
|                                     | Decrement      |         | BE EF  | 03 06 00 | F2 D3 | 05 00        | 06 20  | 00 00 |              |
| Keystone_V                          | Get            |         | BE EF  | 03 06 00 | B9 D3 | 02 00        | 07 20  | 00 00 |              |
|                                     | Increment      |         | BE EF  | 03 06 00 | DF D3 | 04 00        | 07 20  | 00 00 |              |
|                                     | Decrement      |         | BE EF  | 03 06 00 | 0E D2 | 05 00        | 07 20  | 00 00 |              |
| Keystone_H                          | Get            |         | BE EF  | 03 06 00 | E9 D0 | 02 00        | 0B 20  | 00 00 |              |
|                                     | Increment      |         | BE EF  | 03 06 00 | 8F D0 | 04 00        | 0B 20  | 00 00 |              |
|                                     | Decrement      |         | BE EF  | 03 06 00 | 5E D1 | 05 00        | 0B 20  | 00 00 |              |
| Aspect                              | Set            | 4:3     | BE EF  | 03 06 00 | 9E D0 | 01 00        | 08 20  | 00 00 |              |
|                                     |                | 16:9    | BE EF  | 03 06 00 | 0E D1 | 01 00        | 08 20  | 01 00 |              |
|                                     |                | Small   | BE EF  | 03 06 00 | FE D1 | 01 00        | 08 20  | 02 00 |              |
|                                     | Get            |         | BE EF  | 03 06 00 | AD D0 | 02 00        | 08 20  | 00 00 |              |
| Picture Position at 16 : 9 or Small | Set            | Default | BE EF  | 03 06 00 | 62 D1 | 01 00        | 09 20  | 00 00 |              |
|                                     |                | Bottom  | BE EF  | 03 06 00 | F2 D0 | 01 00        | 09 20  | 01 00 |              |
|                                     |                | Top     | BE EF  | 03 06 00 | 02 D0 | 01 00        | 09 20  | 02 00 |              |
|                                     | Get            |         | BE EF  | 03 06 00 | 51 D1 | 02 00        | 09 20  | 00 00 |              |
| V.Position                          | Get            |         | BE EF  | 03 06 00 | 0D 83 | 02 00        | 00 21  | 00 00 |              |
|                                     | Increment      |         | BE EF  | 03 06 00 | 6B 83 | 04 00        | 00 21  | 00 00 |              |
|                                     | Decrement      |         | BE EF  | 03 06 00 | BA 82 | 05 00        | 00 21  | 00 00 |              |
| H.Position                          | Get            |         | BE EF  | 03 06 00 | F1 82 | 02 00        | 01 21  | 00 00 |              |
|                                     | Increment      |         | BE EF  | 03 06 00 | 97 82 | 04 00        | 01 21  | 00 00 |              |
|                                     | Decrement      |         | BE EF  | 03 06 00 | 46 83 | 05 00        | 01 21  | 00 00 |              |
| H.Size                              | Get            |         | BE EF  | 03 06 00 | B5 82 | 02 00        | 02 21  | 00 00 |              |
|                                     | Increment      |         | BE EF  | 03 06 00 | D3 82 | 04 00        | 02 21  | 00 00 |              |
|                                     | Decrement      |         | BE EF  | 03 06 00 | 02 83 | 05 00        | 02 21  | 00 00 |              |
| H.Phase                             | Get            |         | BE EF  | 03 06 00 | 49 83 | 02 00        | 03 21  | 00 00 |              |
|                                     | Increment      |         | BE EF  | 03 06 00 | 2F 83 | 04 00        | 03 21  | 00 00 |              |
|                                     | Decrement      |         | BE EF  | 03 06 00 | FE 82 | 05 00        | 03 21  | 00 00 |              |
| Sharpness                           | Get            |         | BE EF  | 03 06 00 | F1 72 | 02 00        | 01 22  | 00 00 |              |
|                                     | Increment      |         | BE EF  | 03 06 00 | 97 72 | 04 00        | 01 22  | 00 00 |              |
|                                     | Decrement      |         | BE EF  | 03 06 00 | 46 73 | 05 00        | 01 22  | 00 00 |              |
| Color                               | Get            |         | BE EF  | 03 06 00 | B5 72 | 02 00        | 02 22  | 00 00 |              |
|                                     | Increment      |         | BE EF  | 03 06 00 | D3 72 | 04 00        | 02 22  | 00 00 |              |
|                                     | Decrement      |         | BE EF  | 03 06 00 | 02 73 | 05 00        | 02 22  | 00 00 |              |

## Command data chart (continued)

| Names         | Operation type |           | Header |          |          |       | Command data |        |      |
|---------------|----------------|-----------|--------|----------|----------|-------|--------------|--------|------|
|               |                |           |        |          |          |       | CRC          | Action | Type |
| Tint          | Get            |           | BE EF  | 03 06    | 00 49 73 | 02 00 | 03 22        | 00 00  |      |
|               | Increment      |           | BE EF  | 03 06    | 00 2F 73 | 04 00 | 03 22        | 00 00  |      |
|               | Decrement      |           | BE EF  | 03 06    | 00 FE 72 | 05 00 | 03 22        | 00 00  |      |
| Video Format  | Set            | Auto      | BE EF  | 03 06    | 00 9E 75 | 01 00 | 00 22        | 0A 00  |      |
|               |                | NTSC      | BE EF  | 03 06    | 00 FE 71 | 01 00 | 00 22        | 04 00  |      |
|               |                | PAL       | BE EF  | 03 06    | 00 6E 70 | 01 00 | 00 22        | 05 00  |      |
|               |                | SECAM     | BE EF  | 03 06    | 00 6E 75 | 01 00 | 00 22        | 09 00  |      |
|               |                | NTSC 4.43 | BE EF  | 03 06    | 00 5E 72 | 01 00 | 00 22        | 02 00  |      |
|               |                | M-PAL     | BE EF  | 03 06    | 00 FE 74 | 01 00 | 00 22        | 08 00  |      |
|               | N-PAL          | BE EF     | 03 06  | 00 0E 71 | 01 00    | 00 22 | 07 00        |        |      |
|               | Get            |           | BE EF  | 03 06    | 00 0D 73 | 02 00 | 00 22        | 00 00  |      |
| HDTV          | Set            | 1080i     | BE EF  | 03 06    | 00 F2 73 | 01 00 | 05 22        | 00 00  |      |
|               |                | 1035i     | BE EF  | 03 06    | 00 62 72 | 01 00 | 05 22        | 01 00  |      |
|               | Get            |           | BE EF  | 03 06    | 00 C1 73 | 02 00 | 05 22        | 00 00  |      |
| Sync on G     | Set            | off       | BE EF  | 03 06    | 00 CB D0 | 01 00 | 08 30        | 01 00  |      |
|               |                | on        | BE EF  | 03 06    | 00 5B D1 | 01 00 | 08 30        | 00 00  |      |
|               | Get            |           | BE EF  | 03 06    | 00 68 D1 | 02 00 | 08 30        | 00 00  |      |
| WHISPER       | Set            | NORMAL    | BE EF  | 03 06    | 00 3B 23 | 01 00 | 00 33        | 00 00  |      |
|               |                | WHISPER   | BE EF  | 03 06    | 00 AB 22 | 01 00 | 00 33        | 01 00  |      |
|               | Get            |           | BE EF  | 03 06    | 00 08 23 | 02 00 | 00 33        | 00 00  |      |
| GAMMA         | Set            | NORMAL    | BE EF  | 03 06    | 00 C7 F0 | 01 00 | A1 30        | 00 00  |      |
|               |                | CINEMA    | BE EF  | 03 06    | 00 57 F1 | 01 00 | A1 30        | 01 00  |      |
|               |                | DYNAMIC   | BE EF  | 03 06    | 00 A7 F1 | 01 00 | A1 30        | 02 00  |      |
|               | Get            |           | BE EF  | 03 06    | 00 F4 F0 | 02 00 | A1 30        | 00 00  |      |
| Over Scan     | Set            | Large     | BE EF  | 03 06    | 00 C2 71 | 01 00 | 09 22        | 02 00  |      |
|               |                | Middle    | BE EF  | 03 06    | 00 32 71 | 01 00 | 09 22        | 01 00  |      |
|               |                | Small     | BE EF  | 03 06    | 00 A2 70 | 01 00 | 09 22        | 00 00  |      |
|               | Get            |           | BE EF  | 03 06    | 00 91 70 | 02 00 | 09 22        | 00 00  |      |
| MyScreen Size | Set            | Full      | BE EF  | 03 06    | 00 43 D6 | 01 00 | 12 30        | 00 00  |      |
|               |                | X1        | BE EF  | 03 06    | 00 D3 D7 | 01 00 | 12 30        | 01 00  |      |
|               | Get            |           | BE EF  | 03 06    | 00 70 D6 | 02 00 | 12 30        | 03 00  |      |
| MyScreen Lock | Set            | off       | BE EF  | 03 06    | 00 3B EF | 01 00 | C0 30        | 00 00  |      |
|               |                | on        | BE EF  | 03 06    | 00 AB EE | 01 00 | C0 30        | 01 00  |      |
|               | Get            |           | BE EF  | 03 06    | 00 08 EF | 02 00 | C0 30        | 00 00  |      |
| Lamp Time     | Get            |           | BE EF  | 03 06    | 00 C2 FF | 02 00 | 90 10        | 00 00  |      |
| Filter Time   | Get            |           | BE EF  | 03 06    | 00 C2 F0 | 02 00 | A0 10        | 00 00  |      |

# HITACHI

Hitachi, Ltd. Tokyo, Japan  
International Sales Division  
THE HITACHI ATAGO BUILDING,  
No. 15-12 Nishi Shinbashi, 2-Chome,  
Minato-Ku, Tokyo 105-8430, Japan.  
Tel: 03 35022111

## HITACHI EUROPE LTD.

Dukes Meadow  
Millboard Road  
Bourne End  
Buckinghamshire  
SL8 5XF

### UNITED KINGDOM

Tel: 01628 643000

Fax: 01628 643400

Email: [consumer-service@hitachi-eu.com](mailto:consumer-service@hitachi-eu.com)

## HITACHI EUROPE S.A.

364, Kifissias Ave. & 1, Delfon Str.  
152 33 Chalandri  
Athens

### GREECE

Tel: 1-6837200

Fax: 1-6835694

Email: [service.hellas@hitachi-eu.com](mailto:service.hellas@hitachi-eu.com)

## HITACHI EUROPE GmbH

Munich Office  
Dornacher Strasse 3  
D-85622 Feldkirchen bei München

### GERMANY

Tel: +49 -89-991 80-0

Fax: +49 - 89 - 991 80 -224

Hotline: +49 - 180 - 551 25 51 (12ct/min.)

Email: [HSE-DUS.Service@Hitachi-eu.com](mailto:HSE-DUS.Service@Hitachi-eu.com)

## HITACHI EUROPE S.A.

Gran Via Carlos III, 101 - 1  
08028 Barcelona

### SPAIN

Tel: 93 409 2550

Fax: 93 491 3513

Email: [rplan@hitachi-eu.com](mailto:rplan@hitachi-eu.com)

## HITACHI EUROPE AB