

Makita

アメリカ

Cordless Ratchet Wrench

With 3/8" Square Drive Socket Adapter

MODEL 6912D

MODEL 6912DW

With Fast Charger

INSTRUCTION MANUAL

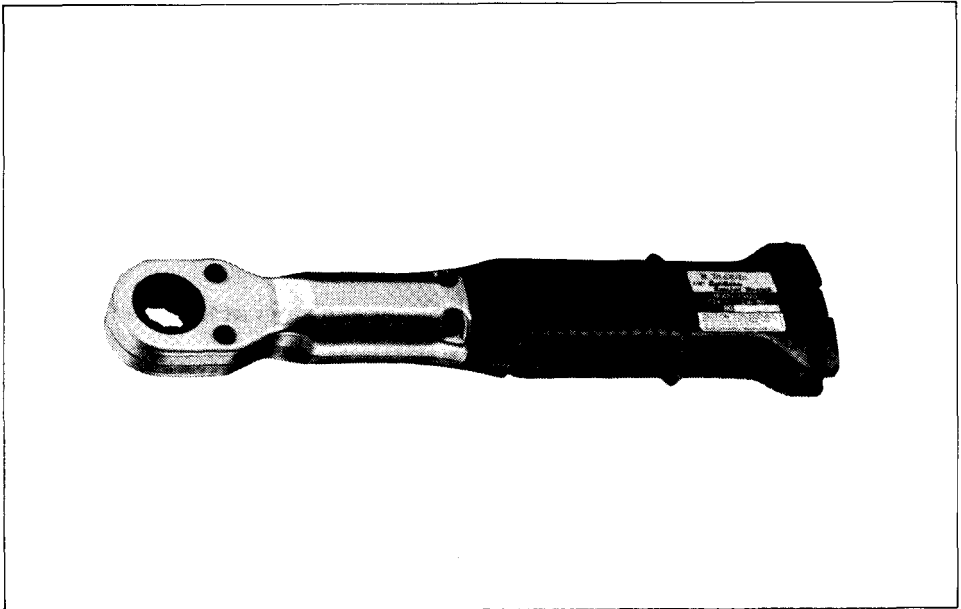

SPECIFICATIONS

Capacities	No load speed (RPM)	Tightening torque	Overall length	Net weight
Bolt size				
12 mm (1/2")	400	38 kg · cm (2.7 ft · lbs)	322 mm (12-11/16")	0.85 kg (1.9 lbs)
• Battery Cartridge 7000		• Model DC7100 Fast Charger		
Voltage	Charging time	Input	Output	
7.2 V	1 Hr.	A.C. only 50 Hz – 60 Hz	D.C. 7.2 V	

- * Manufacturer reserves the right to change specifications without notice.
- * Note: Specifications may differ from country to country.

IMPORTANT SAFETY INSTRUCTIONS

(For All Tools)

WARNING: WHEN USING ELECTRIC TOOLS, BASIC SAFETY PRECAUTIONS SHOULD ALWAYS BE FOLLOWED TO REDUCE THE RISK OF FIRE, ELECTRIC SHOCK, AND PERSONAL INJURY, INCLUDING THE FOLLOWING:

READ ALL INSTRUCTIONS.

1. **KEEP WORK AREA CLEAN.** Cluttered areas and benches invite injuries.
2. **CONSIDER WORK AREA ENVIRONMENT.** Don't use power tools in damp or wet locations. Keep work area well lit. Don't expose power tools to rain. Don't use tool in presence of flammable liquids or gases.
3. **KEEP CHILDREN AWAY.** All visitors should be kept away from work area. Don't let visitors contact tool or extension cord.
4. **STORE IDLE TOOLS.** When not in use, tools should be stored in dry, and high or locked-up place – out of reach of children.
5. **DON'T FORCE TOOL.** It will do the job better and safer at the rate for which it was intended.
6. **USE RIGHT TOOL.** Don't force small tool or attachment to do the job of a heavy-duty tool. Don't use tool for purpose not intended.
7. **DRESS PROPERLY.** Don't wear loose clothing or jewelry. They can be caught in moving parts. Rubber gloves and non-skid footwear are recommended when working outdoors. Wear protective hair covering to contain long hair.
8. **USE SAFETY GLASSES.** Also use face or dust mask if cutting operation is dusty.
9. **DON'T ABUSE CORD.** Never carry tool by cord or yank it to disconnect from receptacle. Keep cord from heat, oil, and sharp edges.
10. **SECURE WORK.** Use clamps or a vise to hold work. It's safer than using your hand and it frees both hands to operate tool.
11. **DON'T OVERREACH.** Keep proper footing and balance at all times.
12. **MAINTAIN TOOLS WITH CARE.** Keep tools sharp and clean for better and safer performance. Follow instructions for lubricating and changing accessories. Inspect tool cords periodically and if damaged, have repaired by authorized service facility. Inspect extension cords periodically and replace if damaged. Keep handles dry, clean, and free from oil and grease.
13. **DISCONNECT TOOLS.** When not in use, before servicing, and when changing accessories, such as blades, bits, cutters.

14. **REMOVE ADJUSTING KEYS AND WRENCHES.** Form habit of checking to see that keys and adjusting wrenches are removed from tool before turning it on.
15. **AVOID UNINTENTIONAL STARTING.** Don't carry plugged-in tool with finger on switch. Be sure switch is OFF when plugging in.
16. **OUTDOOR USE EXTENSION CORDS.** When tool is used outdoors, use only extension cords intended for use outdoors and so marked.
17. **STAY ALERT.** Watch what you are doing, use common sense. Don't operate tool when you are tired.
18. **CHECK DAMAGED PARTS.** Before further use of the tool, a guard or other part that is damaged should be carefully checked to determine that it will operate properly and perform its intended function. Check for alignment of moving parts, binding of moving parts, breakage of parts, mounting, and any other conditions that may affect its operation. A guard or other part that is damaged should be properly repaired or replaced by an authorized service center unless otherwise indicated elsewhere in this instruction manual. Have defective switches replaced by authorized service center. Don't use tool if switch does not turn it on and off.
19. **GUARD AGAINST ELECTRIC SHOCK.** Prevent body contact with grounded surfaces. For example; pipes, radiators, ranges, refrigerator enclosures.
20. **REPLACEMENT PARTS.** When servicing, use only identical replacement parts.

VOLTAGE WARNING: Before connecting the tool to a power source (receptacle, outlet, etc.) be sure the voltage supplied is the same as that specified on the nameplate of the tool. A power source with voltage greater than that specified for the tool can result in **SERIOUS INJURY** to the user — as well as damage to the tool. If in doubt, **DO NOT PLUG IN THE TOOL.** Using a power source with voltage less than the nameplate rating is harmful to the motor.

IMPORTANT SAFETY INSTRUCTIONS

1. **SAVE THESE INSTRUCTIONS** – This manual contains important safety and operating instructions for battery charger.
2. Before using battery charger, read all instructions and cautionary markings on (1) battery charger, (2) battery, and (3) product using battery.
3. **CAUTION** – To reduce risk of injury, charge only MAKITA Battery 7000. Other types of batteries may burst causing personal injury and damage.
4. Do not expose charger to rain or snow.
5. Use of an attachment not recommended or sold by the battery charger manufacturer may result in a risk of fire, electric shock, or injury to persons.
6. To reduce risk of damage to electric plug and cord, pull by plug rather than cord when disconnecting charger.
7. Make sure cord is located so that it will not be stepped on, tripped over, or otherwise subjected to damage or stress.
8. An extension cord should not be used unless absolutely necessary. Use of improper extension cord could result in a risk of fire and electric shock. If extension cord must be used, make sure:
 - a. That pins on plug of extension cord are the same number, size, and shape as those of plug on charger;
 - b. That extension cord is properly wired and in good electrical condition; and
 - c. That wire size is at least as large as the one specified in the table below.

TABLE 1
RECOMMENDED MINIMUM AWG SIZE FOR
EXTENSION CORDS FOR BATTERY CHARGERS

Length of Cord (Feet)	25	50	100	150
AWG Size of Cord	18	18	18	16

9. Do not operate charger with damaged cord or plug – replace them immediately.
10. Do not operate charger if it has received a sharp blow, been dropped, or otherwise damaged in any way; take it to a qualified serviceman.
11. Do not disassemble charger or battery cartridge; take it to a qualified serviceman when service or repair is required. Incorrect reassembly may result in a risk of electric shock or fire.
12. To reduce risk of electric shock, unplug charger from outlet before attempting any maintenance or cleaning. Turning off controls will not reduce this risk.

ADDITIONAL SAFETY RULES FOR CHARGER & BATTERY CARTRIDGE

- 1. Do not charge Battery Cartridge when temperature is BELOW 10°C (50°F) or ABOVE 40°C (104°F).**
- 2. Do not attempt to use a step-up transformer, an engine generator or DC power receptacle.**
- 3. Do not allow anything to cover or clog the charger vents.**
- 4. Always cover the battery terminals with the battery cover when the battery cartridge is not used.**
- 5. A battery short can cause a large current flow, overheating, possible burns and even a breakdown.**
 - (1) Do not touch the terminals with any conductive material.**
 - (2) Avoid storing battery cartridge in a container with other metal objects such as nails, coins, etc.**
 - (3) Do not expose battery cartridge to water or rain.**
- 6. Do not store the tool and Battery Cartridge in locations where the temperature may reach or exceed 50°C (122°F).**
- 7. Do not incinerate the Battery Cartridge even if it is severely damaged or is completely worn out. The battery cartridge can explode in a fire.**

ADDITIONAL SAFETY RULES

- 1. Be aware that this tool is always in an operating condition, because it does not have to be plugged into an electrical outlet.**
- 2. Don't use or leave the tool in damp or wet locations.**
- 3. Don't use in rain.**
- 4. Check the socket carefully for cracks or damage before operation.**
- 5. To prevent bolts or nuts from being damaged, do not overtighten them.**

SAVE THESE INSTRUCTIONS.

Installing or removing battery cartridge

- Always switch off the tool before insertion or removal of the battery cartridge.
- To remove the battery cartridge, pull out the set plate on the tool and grasp both sides of the cartridge while withdrawing it from the barrel.
- To insert the battery cartridge, align the tongue on the battery cartridge with the groove in the housing and slip it into place. Snap the set plate back into place. Be sure to close the set plate fully before using the tool.

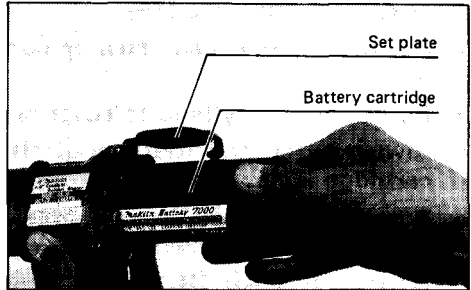

- Do not use force when inserting the battery cartridge. If the cartridge does not slide in easily, it is not being inserted correctly.

Charging

Plug the fast charger into your power source. Insert the battery cartridge so that the plus and minus terminals on the battery cartridge are on the same sides as their respective markings on the fast charger. Insert the cartridge fully into the port so that it rests on the charger port floor.

The charging light will come on and charging will begin. If the charging light does not come on, press the reset button. If the charging light goes out within 10 seconds even after pressing the reset button a couple of times, the battery cartridge is dead. (CAUTION: Wait for more than 5 seconds after the charging light goes out to press the reset button again.) Replace it with a new one. When the charging light goes out after about one hour, you may remove the fully charged battery cartridge.

After charging, unplug the charger from the power source.

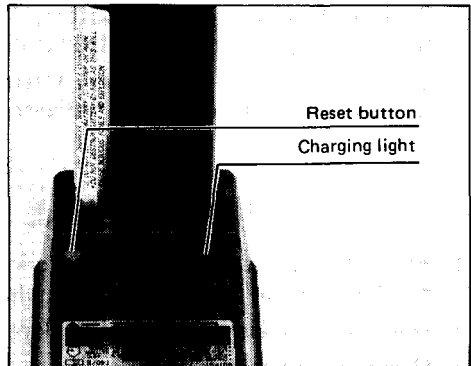

CAUTION:

- Your new battery cartridge is not charged. You will need to charge it before use.
- If you try to charge a cartridge from a just-operated tool, sometimes the charging light will not come on. If this occurs, let the cartridge cool off for a while. Then re-insert it and try to charge it once more.
- When you charge a new battery cartridge or a battery cartridge which has not been used for a long period, it may not accept a full charge. This is a normal condition and does not indicate a problem. You can recharge the battery cartridge fully after discharging it almost completely a couple of times.
- If you wish to charge two battery cartridges, allow 15 minutes between chargings on the fast charger.

Installing socket adapter

When you wish to use a smaller size socket, install the socket adapter.

To install it, insert the socket adapter into the socket in the tool, making sure that the tightening direction matches the arrow on the tool.

To loosen the nut or bolt, turn the tool over (upside-down) and insert the socket adapter into the socket in the tool.

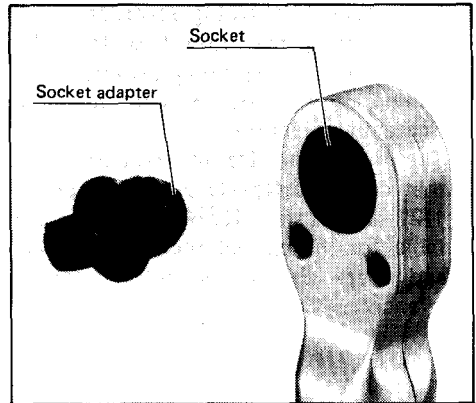

Switch action

To start the tool, simply depress the switch lever. Release the switch lever to stop.

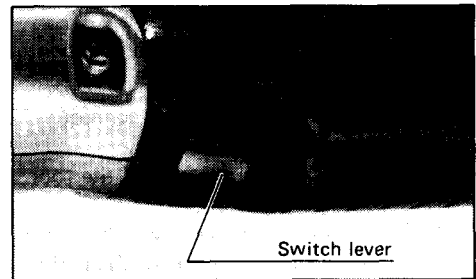

CAUTION:

Before inserting the battery cartridge into the tool, always check to see that the switch lever actuates properly and returns to the "OFF" position when released.

Operation

1. Motor-driven semi-tightening operation

Make sure that the tightening direction matches the arrow on the tool. Hold the tool by the grip area and place the socket over the nut or bolt. Turn the tool on and continue to tighten until the torque limiter actuates, then turn the tool off.

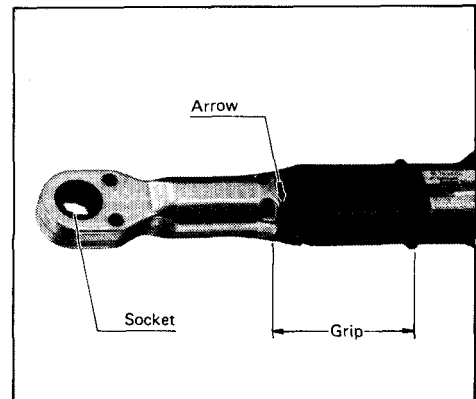

CAUTION:

When operating the tool, be sure to place the socket over the nut or bolt securely.

2. Final manual tightening operation

After turning the tool off, perform the final manual tightening operation by pulling on the tool grip in the same tightening direction.

The maximum size of standard bolts that can be tightened with this tool is 1/2" (socket size: 13/16"). Refer to the table for the correct tightening torque and check the torque with a torque wrench.

Standard bolt size	Tightening torque	Socket size
M8	115 kg . cm (8.3 ft . lbs.)	13 mm
M10	230 kg . cm (16.6 ft . lbs.)	17 mm
M12	400 kg . cm (28.9 ft . lbs.)	19 mm
5/16"	115 kg . cm (8.3 ft . lbs.)	9/16"
3/8"	185 kg . cm (13.4 ft . lbs.)	21/32"
7/16"	296 kg . cm (21.4 ft . lbs.)	3/4"
1/2"	439 kg . cm (31.7 ft . lbs.)	13/16"

CAUTION:

- When performing the final manual tightening operation, be sure to hold the grip area of the tool.
- Avoid the following abusive techniques. They can cause the nut or bolt to break as well as cause tool damage.
 - I) Gripping toward the end of the tool.
 - II) Stepping on the tool.
 - III) Strongly applying your weight to the tool.
 - IV) Attaching a pipe or bar to the end of the tool to create more force on the tool.
- During final tightening, if your hand does not feel an increasing force on the nut or bolt as you pull, the nut or bolt may already be tightened excessively. The nut or bolt may be very close to breaking. Replace the nut or bolt with a new one.

3. Loosening operation

To loosen the nut or bolt, turn the tool over (upside-down). Loosen the nut or bolt by pulling on the tool grip manually in the loosening direction. Then turn the tool on to quickly and efficiently remove the nut or bolt.

MAINTENANCE

CAUTION:

Always be sure that the tool is switched off and the battery cartridge is removed before attempting to perform inspection or maintenance.

To maintain product **SAFETY** and **RELIABILITY**, repairs, maintenance or adjustment should be performed by Makita Authorized or Factory Service Centers, always using Makita replacement parts.

ACCESSORIES

CAUTION:

These accessories or attachments are recommended for use with your Makita tool specified in this manual. The use of any other accessories or attachments might present a risk of injury to persons. The accessories or attachments should be used only in the proper and intended manner.

- **Fast charger**
Model DC7100
Part No. 113086-6



- **Charger 12V for car**
Model DC7112
Part No. 113109-0



- **Socket adapter 9.5**
(Square drive size 3/8")
Part No. 785404-4



- **Battery cartridge 7000**
Part No. 632002-4



- **Battery cover**
Part No. 414938-7



- **Socket adapter 12.7**
(Square drive size 1/2")
Part No. 785403-6



- **Battery holster**
Holster holds extra battery.
Part No. 823033-3C



CORDLESS RATCHET WRENCH Model 6912D

Type 1

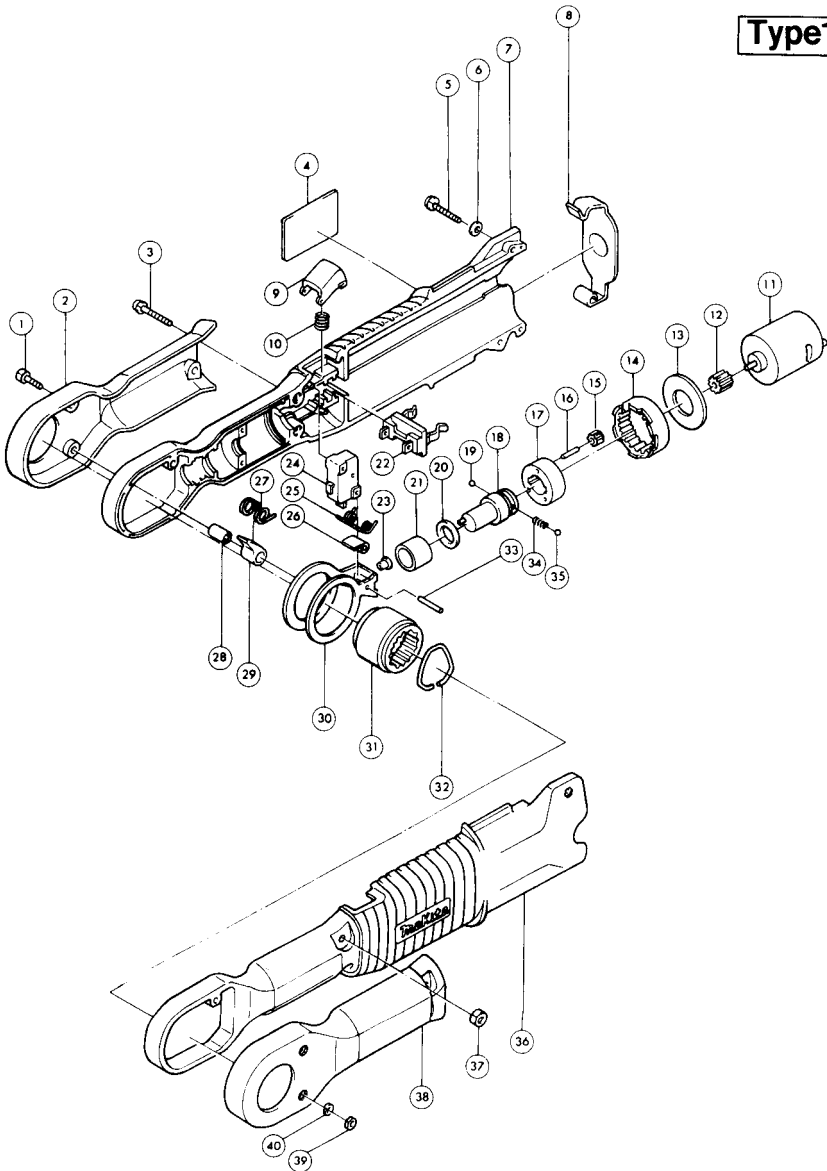

Note: The switch and other part configurations may differ from country to country.



ITEM NO.	NO. USED	DESCRIPTION	ITEM NO.	NO. USED	DESCRIPTION
MACHINE			MACHINE		
1	2	Hex. Socket Head Bolt M4x18	21	1	Needle Bearing 1015
2	1	Sub Housing R	22	1	Battery Holder
3	2	Hex. Socket Head Bolt M4x25 (With Washer)	23	1	Collar
4	1	Name Plate	24	1	Switch
5	2	Hex. Socket Head Bolt M4x25 (With Washer)	25	1	Torsion Spring 5
6	2	Flat Washer 4	26	1	Spring Pawl
7	1	Housing R	27	1	Torsion Spring 7
8	1	Set Plate	28	1	Sleeve 4
9	1	Switch Lever	29	1	Ratchet Pawl
10	1	Compression Spring 6	30	1	Ratchet Holder
11	1	Motor	31	1	Socket 21
12	1	Spur Gear 17	32	1	Ring Spring 18
13	1	Flat Washer 15	33	1	Pin 4
14	1	Internal Gear 49	34	1	Compression Spring 2.4
15	3	Spur Gear 16	35	1	Steel Ball 3.5
16	3	Pin 3	36	1	Housing L
17	1	Clutch Cam	37	4	Hex. Nut M4
18	1	Spindle	38	1	Sub Housing L
19	1	Steel Ball 3.5	39	2	Hex. Nut M4
20	1	Flat Washer 10	40	2	Spring Washer 4

Note: The switch and other part specifications may differ from country to country.

MAKITA LIMITED ONE YEAR WARRANTY

Warranty Policy

Every Makita tool is thoroughly inspected and tested before leaving the factory. It is warranted to be free of defects from workmanship and materials for the period of ONE YEAR from the date of original purchase. Should any trouble develop during this one-year period, return the COMPLETE tool, freight prepaid, to one of Makita's Factory or Authorized Service Centers. If inspection shows the trouble is caused by defective workmanship or material, Makita will repair (or at our option, replace) without charge.

This Warranty does not apply where:

- repairs have been made or attempted by others;
- repairs are required because of normal wear and tear;
- The tool has been abused, misused or improperly maintained;
- alterations have been made to the tool.

IN NO EVENT SHALL MAKITA BE LIABLE FOR ANY INDIRECT, INCIDENTAL OR CONSEQUENTIAL DAMAGES FROM THE SALE OR USE OF THE PRODUCT. THIS DISCLAIMER APPLIES BOTH DURING AND AFTER THE TERM OF THIS WARRANTY.

MAKITA DISCLAIMS LIABILITY FOR ANY IMPLIED WARRANTIES, INCLUDING IMPLIED WARRANTIES OF "MERCHANTABILITY" AND "FITNESS FOR A SPECIFIC PURPOSE," AFTER THE ONE-YEAR TERM OF THIS WARRANTY.

This Warranty gives you specific legal rights, and you may also have other rights which vary from state to state. Some states do not allow the exclusion or limitation of incidental or consequential damages, so the above limitation or exclusion may not apply to you. Some states do not allow limitation on how long an implied warranty lasts, so the above limitation may not apply to you.

Makita Corporation

3-11-8, Sumiyoshi-cho,
Anjo, Aichi 446 Japan

883549D065

PRINTED IN JAPAN

1992 - 5 - N