



# USES OF THIS PROJECTOR

## Features of MULTIMEDIA PROJECTOR SX50

Thank you for purchasing a Canon projector.

The MULTIMEDIA PROJECTOR SX50 is a high-performance, compact, lightweight (3.9 kg/8.6 lbs) projector which supports of SXGA+ resolution (1400 by 1050 dots).

This projector incorporates AISYS, a unique optical engine developed by Canon, allowing the data from the computer and the moving picture from the DVD player to be projected with a high degree of resolution.

### Major Features

#### <High Resolution and High Image Quality>

- ◆ Incorporation of AISYS, Canon's unique optical engine, achieves high resolution, high brightness, high contrast ratio, and best-in-class compactness.
- ◆ A high-resolution reflective liquid crystal panel ensures the display of smooth, beautiful images.
- ◆ 2500 lumens provides brilliant performance even in bright places.
- ◆ Native SXGA+ resolution ensures projection of a high-quality image in a wider projection area as compared with existing models.

#### <Adjustable Projection Angle and Easy Adjustment>

- ◆ A best-in-class 1.7X zoom aspheric lens can project a 100-inch image when placed 3 m (9.8') to 5 m (16.4') away.
- ◆ A newly designed adjustable foot allows you to adjust the vertical projection angle with ease.
- ◆ The "Horizontal and Vertical Keystone Adjustment Function" allows an image to be projected without trapezoidal distortion.
- ◆ The "Auto PC Adjustment Function" automatically makes optimum settings for the connected computer.
- ◆ You can adjust the image quality and make various settings simply by selecting items from the user-friendly menus.

#### <Fine Adjustment of Image Quality and Useful Functions>

- ◆ Four image modes including the sRGB mode are provided to project a variety of images from your computer and DVD player with the best image quality possible.
- ◆ You can project an image on a blackboard (dark green) with natural color.
- ◆ The "Six-axis Color Adjustment Function" allows you to make fine, precise color adjustments.
- ◆ The "Memorized Color Correction Function" can reproduce the colors in our memory vividly, just how we remember them.
- ◆ The "Dynamic Gamma Function" automatically adjusts the balance of contrast.
- ◆ You can customize the logo displayed at the startup or during standby.
- ◆ A password function is provided to prevent unauthorised use.
- ◆ A compact and easy-to-use wireless remote control is supplied to allow you to:
  - Perform all functions of this projector.
  - Operate the mouse on the projected computer screen.
  - Control the projector in a dark room with light-up buttons.
- ◆ The wireless remote control supports functions useful for presentation.
  - "D. ZOOM" (magnification value is displayable) allows you to zoom in or out of a desired portion of an image.
  - "SPOT" (spotlight) allows you to point to a specific portion of an image during presentation.
  - "P-TIMER" shows the elapsed time of presentation.
  - "NO SHOW" allows you to black out an image temporarily.

### COPYRIGHT NOTICE

- ◆ Microsoft, Windows, Windows Me, Windows 2000 and Windows XP are registered trademarks of the U.S. Microsoft Corporation in the U.S. and other countries.
- ◆ XGA, SXGA, SXGA+, and UXGA are U.S. registered trademarks of IBM Corporation.
- ◆ Macintosh is a trademark of the U.S. Apple Computer, Inc. registered in U.S. and other countries.
- ◆ Other company names and product names are registered trademarks or trademarks of the respective companies.

# LOOKING IN THE INDEX

## **Be Sure to Read before Use.**

This section describes important safety and operating instructions.

**SAFETY INSTRUCTIONS**

## **Learning the Names of Parts**

This section describes names of parts. Be sure to read this section.

**BEFORE USE**

## **Setting up the Projector**

This section describes preparations for installing the projector. Be sure to read this section.

**INSTALLING THE PROJECTOR**

## **Projecting an Image from the Computer**

This section describes the procedure for projecting an image from the computer connected to the projector.

**PROJECTING AN IMAGE FROM THE COMPUTER**

## **Learning the Functions Available during Projection**

This section describes the useful functions available during projection. Read this section as required.

**USEFUL FUNCTIONS AVAILABLE DURING PROJECTION**

## **Projecting an Image from AV Equipment**

This section describes the procedure for projecting an image from a digital still camera, digital camcorder, or other AV equipment.

**PROJECTING AN IMAGE FROM AV EQUIPMENT**

## **Menu Functions**

This section describes the functions listed in the menus.

**SETTING UP FUNCTIONS USING MENUS**

## **Projector Maintenance**

This section describes how to clean the projector and replace consumable parts.

**MAINTENANCE**

## **Troubleshooting**

Please read this section if your projector is not performing properly.

**TROUBLESHOOTING**

# SUPPLIED MANUALS AND SYMBOLS USED IN THIS MANUAL

## Supplied Manuals

### User's Manual



This manual provides detailed information about how to use this projector. Read this manual thoroughly to make the most of this projector and ensure safety.

### Quick Start Guide

This guide shows an outline flowchart of the work necessary to make a presentation using this projector.

## Symbols of Buttons

This projector can be operated using buttons on the remote control or main unit. The remote control allows you to use all functions of the projector; however, the buttons on the main unit allow you to use only often-used functions.

In this manual, buttons are indicated by symbols. The symbol of a button on the remote control is shown in  and the symbol of a button on the main unit is shown in . At the beginning of each operational procedure, the position of the button used to perform the operation is described with an illustration.

**1 Press the [MENU] button.**  
The Menu window appears.  
- To close the Menu window, press the [MENU] button again.



Indicates the button on the control on the main unit.

Indicates the button on the remote control.

The screenshot shows the menu window for 'ANALOG RGB-1' with the following settings:

| Setting               | Value       |
|-----------------------|-------------|
| Auto PC adj.          |             |
| Input signal settings |             |
| Input signal select   | 1280 x 1024 |
| Screen settings       | Full screen |
| Menu position         |             |
| User screen settings  |             |
| Image flip H/V        | None        |

## Symbols Used in This Manual

Meanings of the following symbols used in this manual are as follows:



A precaution about operation or restriction is given here.



An important matter that you should be aware of before operation or a useful tip is provided here.

# TABLE OF CONTENTS

|   |           |
|---|-----------|
| <b>USES OF THIS PROJECTOR</b> .....                           | <b>2</b>  |
| <b>LOOKING IN THE INDEX</b> .....                             | <b>3</b>  |
| <b>SUPPLIED MANUALS AND SYMBOLS<br/>IN THIS MANUAL</b> .....  | <b>4</b>  |
| <b>TABLE OF CONTENTS</b> .....                                | <b>5</b>  |
| <b>SAFETY INSTRUCTIONS</b> .....                              | <b>6</b>  |
| <hr/>   |           |
| <b>BEFORE USE</b> .....                                       | <b>14</b> |
| Supplied Accessories .....                                    | 14        |
| Part Names .....  | 15        |
| <hr/>   |           |
| <b>INSTALLING THE PROJECTOR</b> .....                         | <b>20</b> |
| Determining the Distance to the Screen .....                  | 20        |
| <hr/>   |           |
| <b>PROJECTING AN IMAGE FROM<br/>THE COMPUTER</b> .....        | <b>23</b> |
| Connecting the Projector to the Computer..                    | 23        |
| Starting Projection.....                                      | 26        |
| Adjusting the Image .....                                     | 30        |
| Turning Off the Projector.....                                | 35        |
| Setting up the Power Management<br>Function .....             | 36        |
| <hr/>   |           |
| <b>USEFUL FUNCTIONS AVAILABLE<br/>DURING PROJECTION</b> ..... | <b>37</b> |
| Blacking Out an Image Temporarily .....                       | 37        |
| Making an Image Larger/Smaller.....                           | 38        |
| Showing the Elapsed Time .....                                | 39        |
| Indicating a Position with a Spotlight .....                  | 39        |
| Freezing the Picture.....                                     | 40        |
| Muting the Sound/Adjusting the Volume .....                   | 40        |
| Operating the Mouse Using the Remote<br>Control .....         | 41        |

|  |           |
|--|-----------|
| <b>PROJECTING AN IMAGE FROM<br/>AV EQUIPMENT</b> ..... | <b>42</b> |
| Connecting the Projector to AV<br>Equipment.....       | 42        |
| Starting Projection.....                               | 44        |
| Adjusting the Image .....                              | 48        |

|   |           |
|---|-----------|
| <b>SETTING UP FUNCTIONS USING<br/>MENUS</b> ..... | <b>49</b> |
| Using Menus .....                                 | 49        |
| Display Settings Menu .....                       | 52        |
| Image Adj. Menu.....                              | 62        |
| System Settings Menu .....                        | 69        |

|   |           |
|---|-----------|
| <b>MAINTENANCE</b> .....                    | <b>75</b> |
| Cleaning the Projector .....                | 75        |
| Cleaning and Replacing the Air Filter ..... | 76        |
| Replacing the Lamp .....                    | 77        |

|   |           |
|---|-----------|
| <b>TROUBLESHOOTING</b> .....                          | <b>79</b> |
| Understanding the Warning Lamp Flash<br>Patterns..... | 79        |
| Symptoms and Solutions .....                          | 80        |

|   |           |
|---|-----------|
| <b>APPENDIX</b> .....   | <b>84</b> |
| Computer Signal Types.....  | 84        |
| Relationship between Screen Size and<br>Projection Distance ..... | 85        |
| Menu Configuration.....   | 86        |
| Glossary .....  | 88        |
| Specifications.....   | 90        |

\* “Display Settings Menu”, “Image Adj. Menu” and “System Settings Menu” have detailed contents on their title pages.

# SAFETY INSTRUCTIONS

Before operating this projector, read this manual thoroughly and operate the projector properly.

This projector provides many convenient features and functions. Operating the projector properly enables you to manage those features and maintains it in better condition for a considerable time.

Improper operation may result in not only shortening the product-life, but also malfunctions, fire hazard, or other accidents.

If your projector seems to operate improperly, read this manual again, check operations and cable connections and try the solutions in the "Troubleshooting" section in the end of this booklet. If the problem still persists, contact the dealer where you purchased the projector or the service center.



**CAUTION**  
**RISK OF ELECTRIC SHOCK**  
**DO NOT OPEN**



**CAUTION :** TO REDUCE THE RISK OF ELECTRIC SHOCK, DO NOT REMOVE COVER (OR BACK). NO USER-SERVICEABLE PARTS INSIDE EXCEPT LAMP REPLACEMENT. REFER SERVICING TO QUALIFIED SERVICE PERSONNEL.



THIS SYMBOL INDICATES THAT DANGEROUS VOLTAGE CONSTITUTING A RISK OF ELECTRIC SHOCK IS PRESENT WITHIN THIS UNIT.



THIS SYMBOL INDICATES THAT THERE ARE IMPORTANT OPERATING AND MAINTENANCE INSTRUCTIONS IN THE OWNER'S MANUAL WITH THIS UNIT.

**CAUTION**

Not for use in a computer room as defined in the Standard for the Protection of Electronic Computer/Data Processing Equipment, ANSI/NFPA 75.

**Safety Precaution**

**WARNING : TO REDUCE THE RISK OF FIRE OR ELECTRIC SHOCK, DO NOT EXPOSE THIS APPLIANCE TO RAIN OR MOISTURE.**

- This projector produces intense light from the projection lens. Do not stare directly into the lens as possible. Eye damage could result. Be especially careful that children do not stare directly into the beam.
- Install the projector in a proper position. If not, it may result in a fire hazard.
- Provide appropriate space on the top, sides and rear of the projector cabinet for allowing air circulation and cooling the projector. Minimum clearance must be maintained. If the projector is to be built into a compartment or similarly enclosed, the minimum distances must be maintained. Do not cover the ventilation slot on the projector. Heat build-up can reduce the service life of your projector, and can also be dangerous.

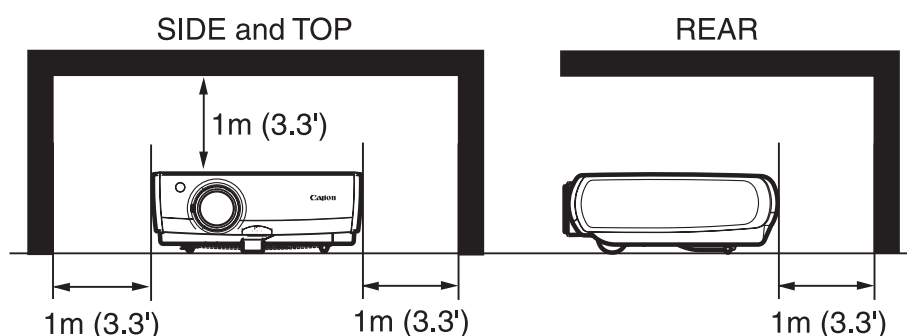

- Do not put any flammable object or spray can near the projector, hot air is exhausted from the ventilation holes.
- If the projector is not to be used for an extended time, unplug the projector from the power outlet.

## READ AND KEEP THIS OWNER'S MANUAL FOR LATER USE.

All the safety and operating instructions should be read before the product is operated.

Read all of the instructions given here and retain them for later use. Unplug this projector from AC power supply before cleaning. Do not use liquid or aerosol cleaners. Use a damp cloth for cleaning.

Follow all warnings and instructions marked on the projector.

For added protection to the projector during a lightning storm, or when it is left unattended and unused for long periods of time, unplug it from the wall outlet. This will prevent damage due to lightning and power line surges.

---

Do not expose this unit to rain or use near water... for example, in a wet basement, near a swimming pool, etc...

Do not use attachments not recommended by the manufacturer as they may cause hazards.

Do not place this projector on an unstable cart, stand, or table. The projector may fall, causing serious injury to a child or adult, and serious damage to the projector. Use only with a cart or stand recommended by the manufacturer, or sold with the projector. Wall or shelf mounting should follow the manufacturer's instructions, and should use a mounting kit approved by the manufacturers.

An appliance and cart combination should be moved with care. Quick stops, excessive force, and uneven surfaces may cause the appliance and cart combination to overturn.





Slots and openings in the back and bottom of the cabinet are provided for ventilation, to insure reliable operation of the equipment and to protect it from overheating.

The openings should never be covered with cloth or other materials, and the bottom opening should not be blocked by placing the projector on a bed, sofa, rug, or other similar surface. This projector should never be placed near or over a radiator or heat register.

This projector should not be placed in a built-in installation such as a book case unless proper ventilation is provided.

Never push objects of any kind into this projector through cabinet slots as they may touch dangerous voltage points or short out parts that could result in a fire or electric shock. Never spill liquid of any kind on the projector.

Do not install the projector near the ventilation duct of air-conditioning equipment.

This projector should be operated only from the type of power source indicated on the marking label. If you are not sure of the type of power supplied, consult your authorized dealer or local power company.

Do not overload wall outlets and extension cords as this can result in fire or electric shock. Do not allow anything to rest on the power cord. Do not locate this projector where the cord may be damaged by persons walking on it.

Do not attempt to service this projector yourself as opening or removing covers may expose you to dangerous voltage or other hazards. Refer all servicing to qualified service personnel.

Unplug this projector from wall outlet and refer servicing to qualified service personnel under the following conditions:

- a. When the power cord or plug is damaged or frayed.
- b. If liquid has been spilled into the projector.
- c. If the projector has been exposed to rain or water.
- d. If the projector does not operate normally by following the operating instructions. Adjust only those controls that are covered by the operating instructions as improper adjustment of other controls may result in damage and will often require extensive work by a qualified technician to restore the projector to normal operation.
- e. If the projector has been dropped or the cabinet has been damaged.
- f. When the projector exhibits a distinct change in performance-this indicates a need for service.

When replacement parts are required, be sure the service technician has used replacement parts specified by the manufacturer that have the same characteristics as the original part. Unauthorized substitutions may result in fire, electric shock, or injury to persons.

Upon completion of any service or repairs to this projector, ask the service technician to perform routine safety checks to determine that the projector is in safe operating condition.

## AC POWER CORD REQUIREMENT

The AC Power Cord supplied with this projector meets the requirement for use in the country you purchased it.

### AC Power Cord for the United States and Canada :

AC Power Cord used in the United States and Canada is listed by the Underwriters Laboratories (UL) and certified by the Canadian Standard Association (CSA).

AC Power Cord has a grounding-type AC line plug. This is a safety feature to be sure that the plug will fit into the power outlet. Do not try to defeat this safety feature. Should you be unable to insert the plug into the outlet, contact your electrician.

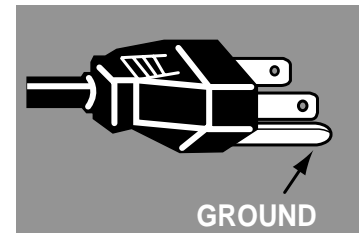

**THE SOCKET-OUTLET SHOULD BE INSTALLED NEAR THE EQUIPMENT AND EASILY ACCESSIBLE.**

### NOTE FOR CUSTOMERS IN THE US

(Hg) LAMP(S) INSIDE THIS PRODUCT CONTAIN MERCURY AND MUST BE RECYCLED OR DISPOSED OF ACCORDING TO LOCAL, STATE OR FEDERAL LAWS.

## **Federal Communication Commission Notice**

Multimedia Projector, Model : SX50

This device complies with Part 15 of the FCC Rules. Operation is subject to the following two conditions:

- (1) This device may not cause harmful interference, and
- (2) this device must accept any interference received, including interference that may cause undesired operation.

Note : This equipment has been tested and found to comply with the limits for a Class B digital device, pursuant to part 15 of the FCC Rules. These limits are designed to provide reasonable protection against harmful interference in a residential installation. This equipment generates, uses and can radiate radio frequency energy and, if not installed and used in accordance with the instructions, may cause harmful interference to radio communications. However, there is no guarantee that interference will not occur in a particular installation. If this equipment does cause harmful interference to radio or television reception, which can be determined by turning the equipment off and on, the user is encouraged to try to correct the interference by one or more of the following measures :

- Reorient or relocate the receiving antenna.
- Increase the separation between the equipment and receiver.
- Connect the equipment into an outlet on a circuit different from that to which the receiver is connected.
- Consult the dealer or an experienced radio/TV technician for help.

The cable with the ferrite core provided with the projector must be used with this equipment in order to comply with Class B limits in Subpart B of Part 15 of the FCC rules.

Use of shielded cable is required to comply with class B limits in Subpart B of Part 15 of FCC Rules.

Do not make any changes or modifications to the equipment unless otherwise specified in the instructions. If such changes or modifications should be made, you could be required to stop operation of the equipment.

Canon U.S.A., Inc.

One Canon Plaza, Lake Success, NY 11042, U.S.A.

Tel No. (516)328-5600

## **Canadian Radio Interference Regulations**

This Class B digital apparatus meets all requirements of the Canadian Interference-Causing Equipment Regulations.



## LAMP HANDLING PRECAUTIONS

This projector uses a high-pressure mercury lamp which must be handled carefully and properly as mentioned below.

- A lamp may explode with a loud sound or burn out due to a shock, scratch, or expiration of lifetime.
- The lamp life may differ from lamp to lamp and according to the environment of use. There is not guarantee of the same lifetime for each lamp. Some lamps may fail or terminate their life in a shorter period of time than other similar lamps.
- A lamp gradually becomes darker with time of use.
- If the projector indicates that the lamp should be replaced (i.e., the LAMP REPLACE indicator lights up twice), chances of explosion become higher. Replace the lamp with a new one immediately.
- Always keep your face away from the exhaust vent so that you do not suffer from the gas and broken shards of the lamp.



### IF A LAMP EXPLODES

If a lamp explodes, the gas and broken shards may scatter inside the projector and they may come out of the exhaust vent. The gas contains toxic mercury. Open windows and doors for ventilation.

If you inhale the gas or the shards of the broken lamp enter your eyes or mouth, consult the doctor immediately.

If a lamp explodes, its shards may scatter inside the projector. Ask the Canon service representative to clean and check the inside of the projector and replace the lamp.



### DISPOSAL OF WASTE LAMP

Dispose of the mercury lamp of the projector according to the local regulation just like the fluorescent lamp.

## CARRYING/TRANSPORTING THE PROJECTOR

This projector is a precision machine. Do not give a strong shock to the projector or turn it down.

Thoroughly read “Use Caution When Carrying or Transporting the Projector” below and install the lens cap before carrying the projector. When transporting the projector by train or airplane, use a highly crashworthy transport case.

### Use Caution When Carrying or Transporting the Projector

The carrying bag is intended for protection from dust and scratches on the surface of the cabinet, and it is not designed to protect the projector from external shocks. When carrying the projector with it put in the carrying bag, do not give a shock to it, drop it, or place anything on it. Do not transport the projector through a courier or transport service with the carrying bag. The projector can damage.

# INSTALLATION PRECAUTIONS

Ensure that the projector is installed with a minimum distance of 1 m (3.3') from its left, right, rear, and top panels to the neighboring object such as a wall.

## Pay Attention to Hot Air from Exhaust Vent

Hot air is exhausted from the exhaust vent. Do not place any object near the exhaust vent.

- Do not put any spray can near the vent. The internal pressure increases due to heat, resulting in explosion.
- Do not put any metallic object. It may become hot, resulting in an accident or injury.
- Do not put anything such as a plant pot.
- Do not put anything that may deform or deteriorate due to heat.
- Do not put an audience seat near the exhaust vent.

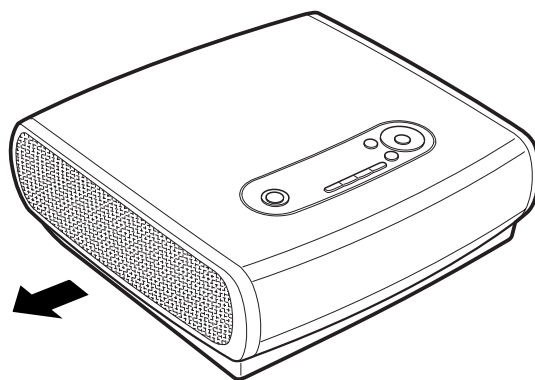

Do not put anything that may deform or discolor due to heat on the projector. The area around the exhaust vent and the cabinet above the exhaust vent become hot. Do not touch these areas, or you may get burnt. Especially, keep children away from these areas.

## Do Not Use in the Following Environments

Do not install the projector in a humid or dusty place or a place where there is much oily smoke or cigarette smoke. Optical parts such as a lens and mirror are stained, resulting in poor picture.

Do not use the projector in a place where the temperature becomes very high or low.

|                                      |                                     |
|--------------------------------------|-------------------------------------|
| Operating temperature: +5°C to +35°C | Storage temperature: -10°C to +60°C |
|--------------------------------------|-------------------------------------|

## Pay Attention to Condensation

If the projector is carried from a cold place to a warm place or the room temperature is raised rapidly, dew may form on the lens and mirror due to the moisture in the atmosphere, resulting in a blurred picture. Wait until dew evaporates and a normal picture is shown.

## Install the Projector at Proper Position

Install the projector properly. Improper installation may cause troubles and accidents.

- Do not tilt the projector more than 20 degrees above and below.
- Do not point the projector up.
- Do not point the projector down.
- Do not put the projector on either side.

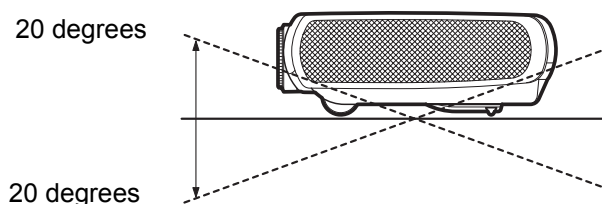

Do not tilt the projector more than 20 degrees above and below.

# BEFORE USE

## Supplied Accessories

Check whether the following accessories are supplied with the projector.

Remote control

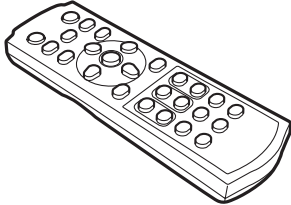

Batteries (type AAA, two)  
for remote control

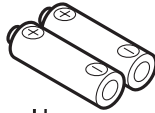

Computer connection cable  
(DVI/Mini D-sub, 15-pin) (1.8m/5.9')

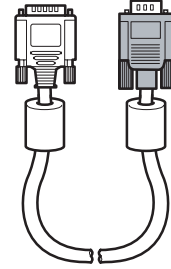

USB cable (1.8m/5.9')

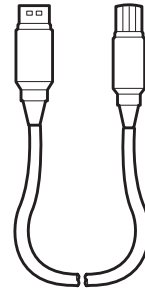

Power cord (2m/6.6')

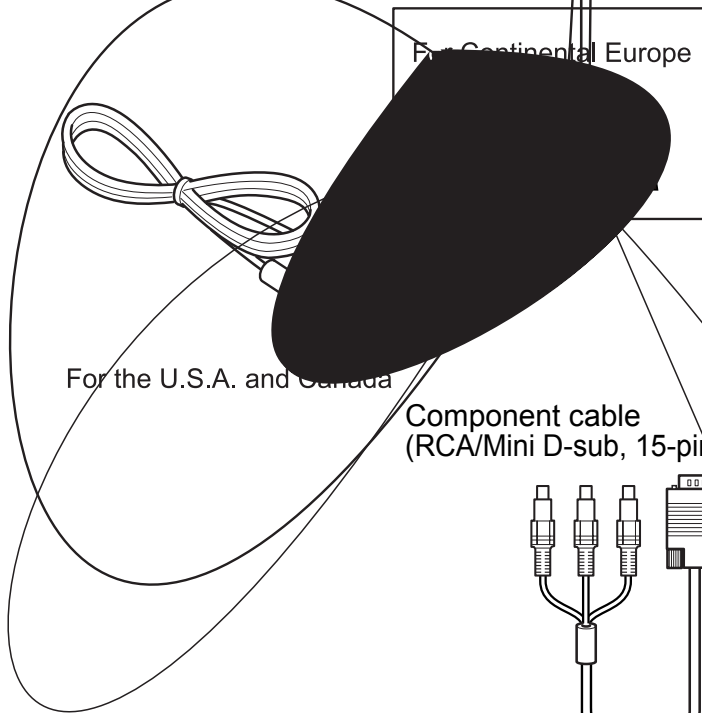

For Continental Europe

For the U.S.A. and Canada

Component cable  
(RCA/Mini D-sub, 15-pin) (0.4m/1.3')

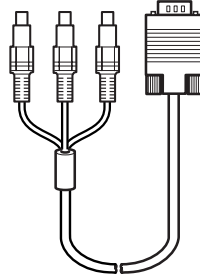

User's Manual  
Quick Start Guide  
Warranty card

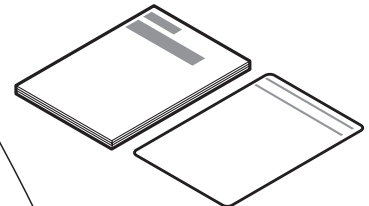

Lens cap



Carrying bag (P12)

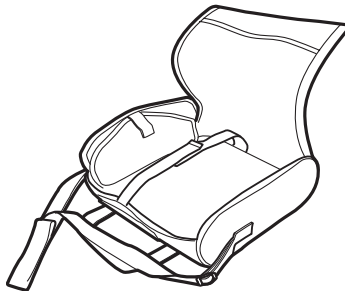

Lens cap strap

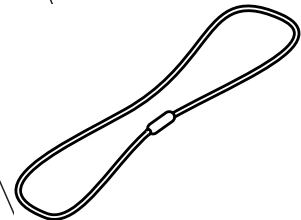

Tie the lens cap to the projector with the supplied strap. For the procedure, see page 92.



- When the projector is not in use, attach the lens cap to protect the lens from dust and other foreign objects.
- Be sure to attach the ferrite core to the power cord.









# Top Control

BEFORE USE

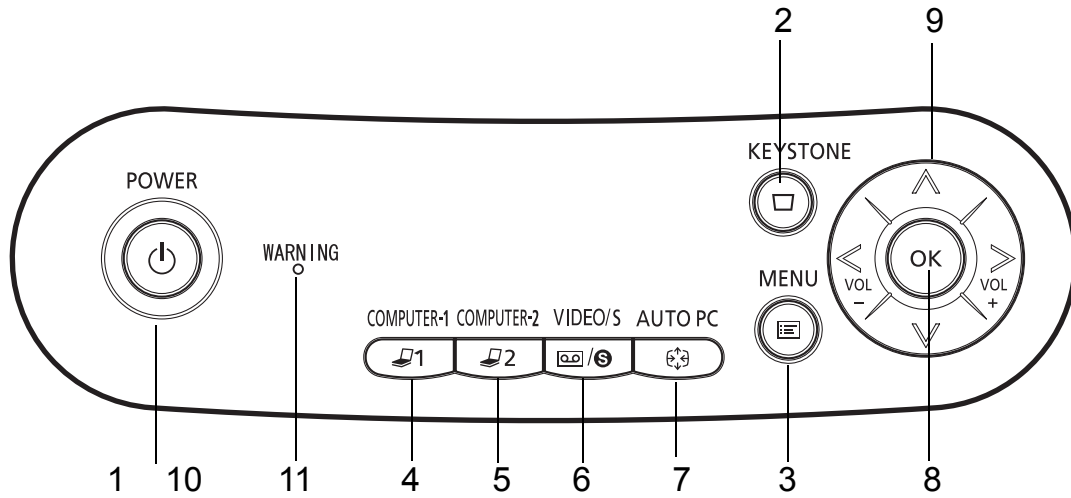

- 1 POWER button (P27, 45)**  
Turns the projector on or off.
- 2 KEYSTONE button (P31)**  
Corrects keystone distortion.
- 3 MENU button (P50)**  
Displays a menu.
- 4 COMPUTER-1 button (P28, 46)**  
Selects the image input from the DVI-I/RGB IN-1 terminal.  
Pressing this button continuously allows you to select an input signal (DIGITAL RGB or ANALOG RGB-1).
- 5 COMPUTER-2 button (P28, 46)**  
Selects the image input from the RGB IN-2/ COMPONENT IN/RGB OUT terminal.  
Pressing this button continuously allows you to select an input signal (ANALOG RGB-2 or COMPONENT).
- 6 VIDEO/S button (P46)**  
Select the image input from the VIDEO IN terminal or S-VIDEO terminal.  
Pressing this button continuously allows you to select input signals (VIDEO or S-VIDEO).
- 7 AUTO PC button (P29)**  
When ANALOG RGB-1 or ANALOG RGB-2 is selected, performs the auto PC adjustment to adjust the tracking, total number of dots, and image position automatically.
- 8 OK button (P51)**  
Determines the item selected from the menu.
- 9 POINTER button (P50)**  
Selects the upper, lower, left, or right item in the menu. The left and right buttons are also used as volume control buttons.
- 10 POWER indicator (P27)**  
Indicates the projector status.  
When stays red: The projector can be turned on.  
When flashing red: The projector is being turned off (the lamp is being cooled).  
When stays green: The projector is on.  
When flashing green: The projector is being turned on.
- 11 WARNING lamp (P79)**  
Flashes red when a problem has been detected.

## Input Terminals on Main Unit

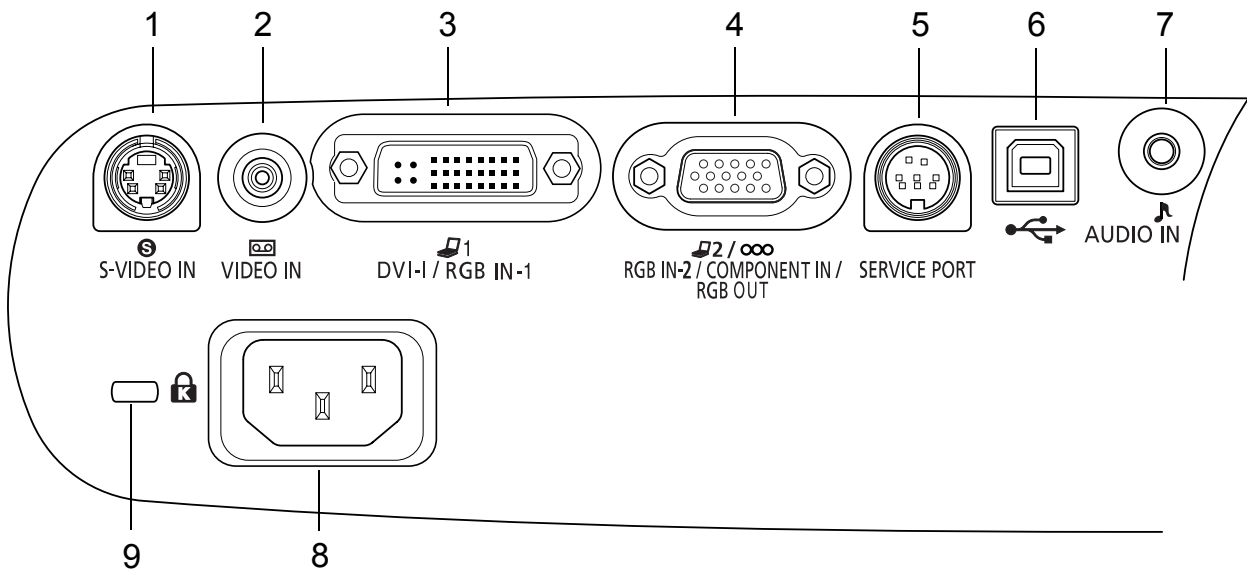

### 1 S-VIDEO IN terminal (P42)

Receives an S-VIDEO signal from AV equipment.

### 2 VIDEO IN terminal (P42)

Receives a composite video signal from AV equipment.

### 3 DVI-I/RGB IN-1 terminal (P23, 42)

Receives a digital or analog RGB signal from the computer (DVI terminal).

### 4 RGB IN-2/COMPONENT IN/RGB OUT terminal (P23, 42)

Receives an analog RGB signal from the computer or receives a component picture signal from AV equipment (mini D-sub 15-pin terminal).

Also used to output an analog RGB signal by selecting an option from the menu.

### 5 SERVICE PORT jack

Exclusively used by the service personnel (it is not used normally).

### 6 USB terminal (P41)

Connected to the computer with a USB cable when the remote control is used as the mouse of the computer.

### 7 AUDIO IN terminal (P24, 43)

Receives an audio signal (stereo) from the computer or AV equipment.

### 8 Power cord socket (P26)

### 9 Antitheft lock hole

Allows you to connect an antitheft cable.

# INSTALLING THE PROJECTOR

## Determining the Distance to the Screen

The projected image size is determined by the distance between the projector lens and the screen.

Select the place where the desired image size is obtained according to the figure shown below.

The image size can be adjusted using the Zoom lever by the lens.

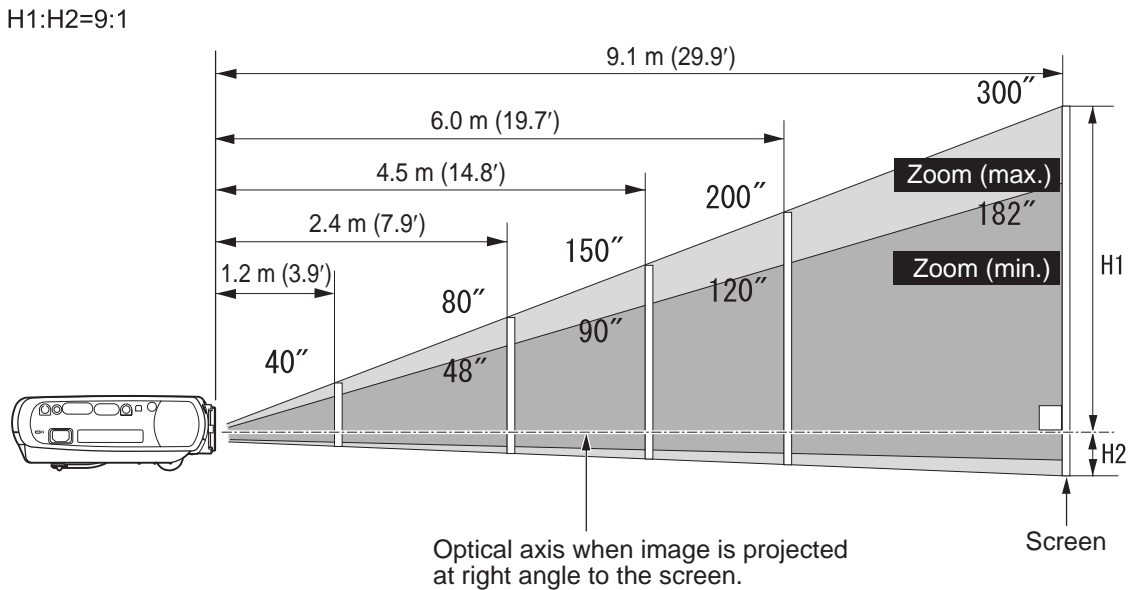

H1 and H2: H1 is the height of the screen from the intersection of optical axis and screen surface, and H2 is the height of the intersection when an image is projected at right angle to the screen.

| Screen size (W x H) cm            | 40"<br>81 x 61  | 60"<br>122 x 91 | 80"<br>163 x 122 | 100"<br>203 x 152 | 150"<br>305 x 229 | 182"<br>370 x 277 | 200"<br>406 x 305 | 250"<br>508 x 381 | 300"<br>610 x 457 |
|-----------------------------------|-----------------|-----------------|------------------|-------------------|-------------------|-------------------|-------------------|-------------------|-------------------|
| Projection distance<br>Zoom (max) | 2.0 m<br>(6.6') |                 |                  |                   |                   |                   | -                 | -                 | -                 |
| Projection distance<br>Zoom (min) | 1.2 m<br>(3.9') |                 |                  |                   |                   |                   |                   |                   |                   |
| H1                                | 55 cm<br>(1.8') | 40 cm<br>(1.3') | 53 cm<br>(1.7')  | 63 cm<br>(2.1')   | 95 cm<br>(3.1')   | 115 cm<br>(3.8')  | 130 cm<br>(4.3')  | 165 cm<br>(5.4')  | 200 cm<br>(6.6')  |
| H2                                | 81 x 61         | 122 x 91        | 163 x 122        | 203 x 152         | 305 x 229         | 370 x 277         | 406 x 305         | 508 x 381         | 610 x 457         |

- Install the projector at the position where the projection distance is about 1.2 m (3.9') to 9.1 m (29.9'). If the installation position is too close, the image is out of focus. If the installation position is too far, the screen becomes dark.
- The sizes in the above table have been obtained assuming that the aspect ratio is 4:3. They may vary from the actual sizes depending on the type of the projected image.



For the relationship between the screen size and projection distance, see the table on page 85.

## Determining the Installation Place

### Placing in Front of the Screen

Place the projector in front of the screen in such a manner that it is as perpendicular to the screen as possible.

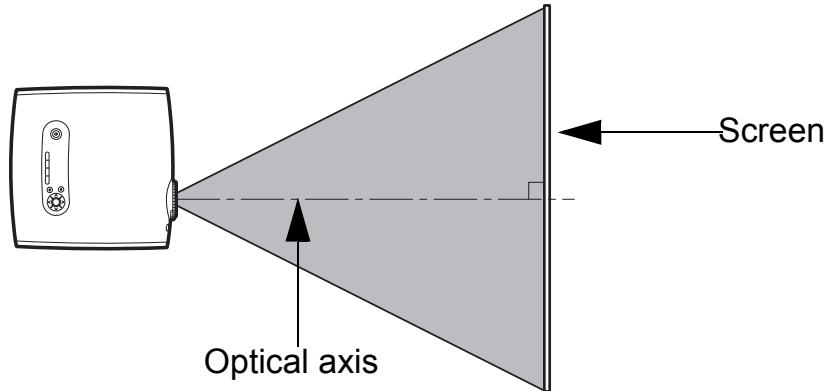

A slight error in the projection angle can be corrected using the KEYSTONE button. (P31)

### Placing on a Level Place

Place the projector on a level place.

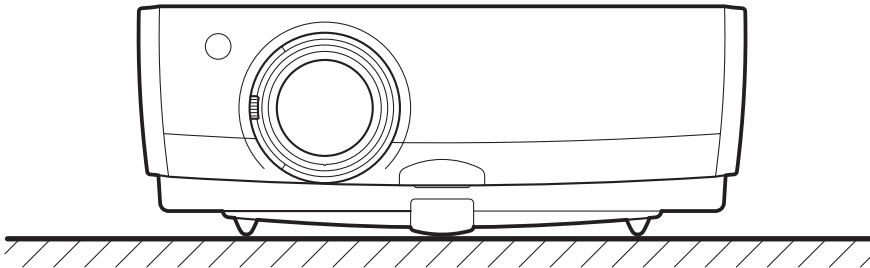

- Make sure that the installation place is free from any obstacle that may block the exhaust vent (fan) on the right side of the projector and the air intake vent (air filter) on the bottom of the projector.
- The screen must not be exposed to direct sunlight or light from lighting equipment. In a bright room, it is recommended to limit ambient lighting in order to improve the image quality.

## Note

This projector can be hung from the ceiling (Ceiling mounted) with it turned up side down. When a translucent screen is used, the projector can project an image from behind the screen (Rear).

When the projector is hung from the ceiling or projector projects an image from behind the screen, the image must be inverted vertically or horizontally. (P61)



When hanging the projector from the ceiling, optional brackets (part No. RS-CL01) are required.

## Adjusting the Projection Angle

The projection angle can be adjusted with the adjustable foot.

Before making this adjustment, connect the computer and AV equipment and project an image on the screen.

- 1 Lift the front of the projector and push the adjusting foot lock.**

The adjustable foot extends with the spring force.

- 2 Adjust the projection angle while pushing the adjustable foot lock, and then release the lock.**

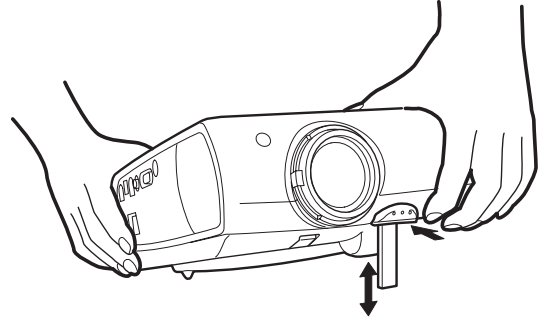

- With the adjustable foot, the projection angle can be adjusted up to 10 degrees. Adjust the longitudinal tilt of the projector to +/-20 degrees or less. If the tilt is more than 20 degrees above and below, a lamp problem can result.

### If Keystone Distortion is Large

Extending the adjustable foot too far causes keystone distortion (the projected picture is trapezoidal). If the distortion is large, adjust the height of the pedestal of the projector.

The keystone distortion can be corrected using the KEYSTONE button. (P31)

Keystone distortion of image

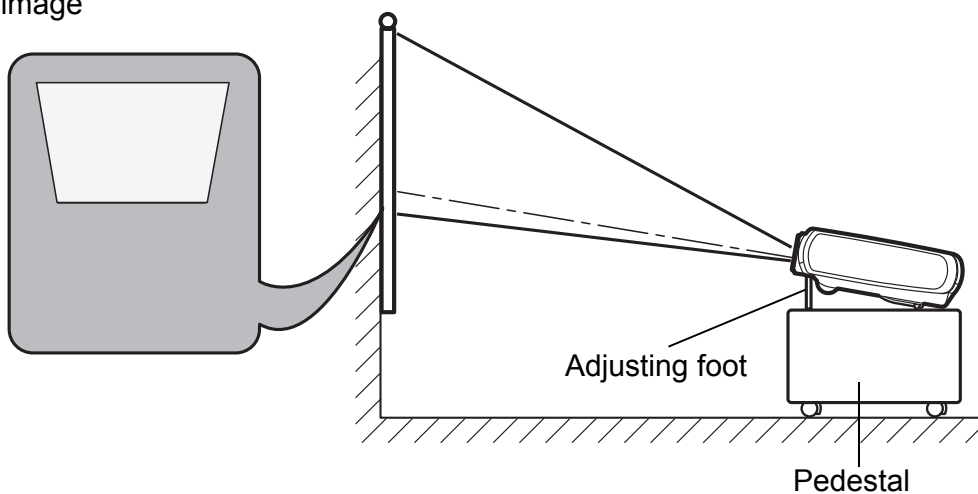

# PROJECTING AN IMAGE FROM THE COMPUTER

## Connecting the Projector to the Computer

Connect the projector to the computer.

### Connecting to Video Terminals

- Before connecting cables, turn off both the projector and computer.
- Images may be improperly projected with digital RGB signals in 1280 x 1024 or 1400 x 1050 depending on the type of computer or DVI cable.
- The USB terminal is used to use the remote control just like the computer mouse. Images cannot be projected simply by connecting the USB cable.

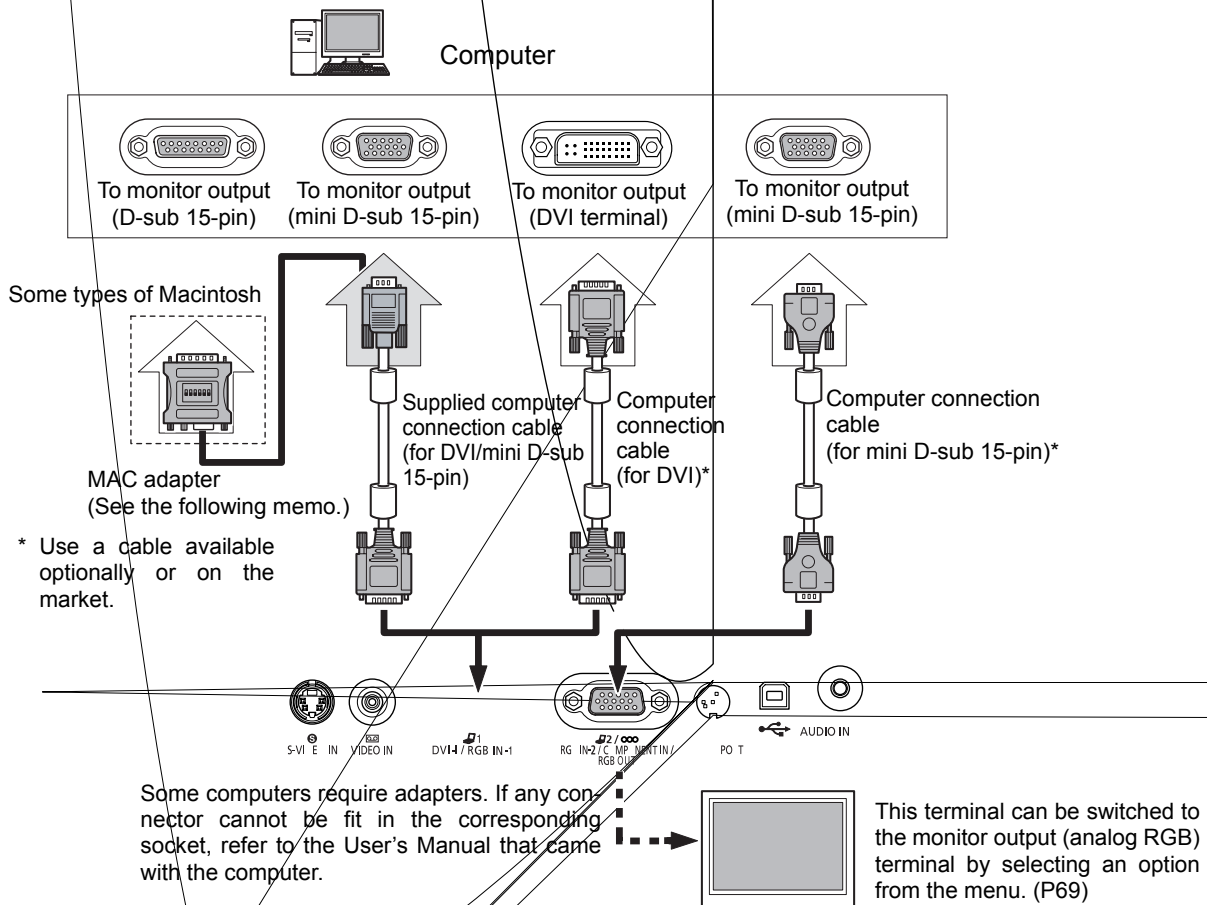

PROJECTING AN IMAGE FROM THE COMPUTER

To ensure projection of high-resolution high-quality images, use of high-performance cables is recommended.

### MAC Adapter (part No. LV-AD02)

For the Macintosh having a D-sub 15-pin (standard) terminal for monitor output, use a MAC adapter. Set the slide switches (1-6) on the adapter depending on the Macintosh mode as shown below.

|                       | 1   | 2  | 3   | 4   | 5   | 6   |
|-----------------------|-----|----|-----|-----|-----|-----|
| 13" MODE (640 x 480)  | ON  | ON | OFF | OFF | OFF | OFF |
| 16" MODE (832 x 624)  | OFF | ON | OFF | ON  | OFF | OFF |
| 19" MODE (1024 x 768) | OFF | ON | ON  | OFF | OFF | OFF |
| 21" MODE (1152 x 870) | ON  | ON | ON  | ON  | OFF | OFF |

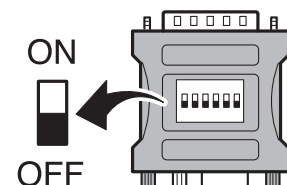

## Connecting to Audio Terminals

 Before connecting cables, turn off both the projector and computer.

Connect audio cables as required.

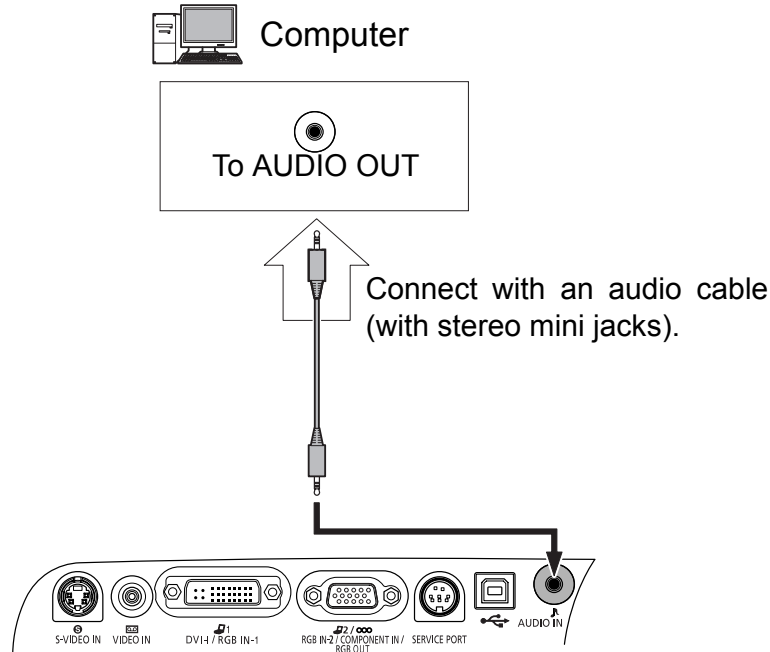

-  Use an audio cable without a built-in resistor. Using an audio cable with a built-in resistor turns down the sound.
- The built-in speaker is monaural.
- The speaker plays the sound from the equipment which the audio cable is connected to.

## Projecting the Image from the Notebook Computer

No image is projected if the external monitor output is turned off on the personal computer side.

To turn on the external monitor output, press the [LCD] or [VGA] function key while pressing the Fn key on the keyboard of the personal computer.

The following table shows relationships between personal computer manufacturers and key combinations.

|           |            |              |         |            |             |
|-----------|------------|--------------|---------|------------|-------------|
| FUJITSU   | All series | [Fn] + [F10] | HITACHI | All series | [Fn] + [F7] |
| SONY      | All series | [Fn] + [F7]  | COMPAQ  | PRESARIO   | [Fn] + [F7] |
| Panasonic | All series | [Fn] + [F3]  |         | ARMADA     | [Fn] + [F4] |
| SHARP     | All series | [Fn] + [F5]  | DELL    | All series | [Fn] + [F8] |
| TOSHIBA   | All series | [Fn] + [F5]  | GATEWAY | All series | [Fn] + [F3] |
| NEC       | All series | [Fn] + [F3]  | SOTEC   | All series | [Fn] + [F3] |
| IBM       | All series | [Fn] + [F3]  | akia    | All series | [Fn] + [F2] |

 For the key combination of the computer series not listed in the above table, refer to the User's Manual that came with the computer.



## Determining the Output Resolution of the Computer

To make the most of the display performance of this projector, set output signal resolution of the computer to an optimum value. If the resolution set on the computer is low, the quality of the projected image is poor.

The procedure for adjusting the resolution is as follows:

### Windows XP

1. Open the [Start] menu and select Control Panel.
2. In the Control Panel window, double-click the [Display] icon to display the Display Properties window.
3. Select the [Settings] tab and move the slider to select "1400 by 1050 pixels". If this resolution is not available, select the highest resolution under 1400 by 1050.
4. Click the [OK] button.

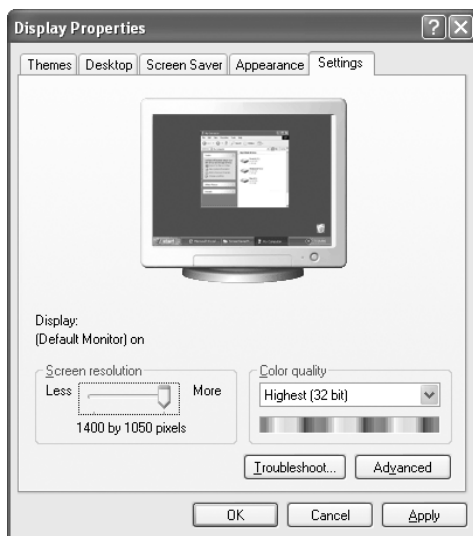

### Macintosh OSX

1. Open the Apple Menu and select [System Environment Setting].
2. In the System Environment Setting window, click the [Displays] icon to display the Display window.
3. Select the [Display] tab and select "1400 x 1050" from the [Resolution] list. If this setting is not available, select the highest resolution under 1400 x 1050.
4. Close the windows.

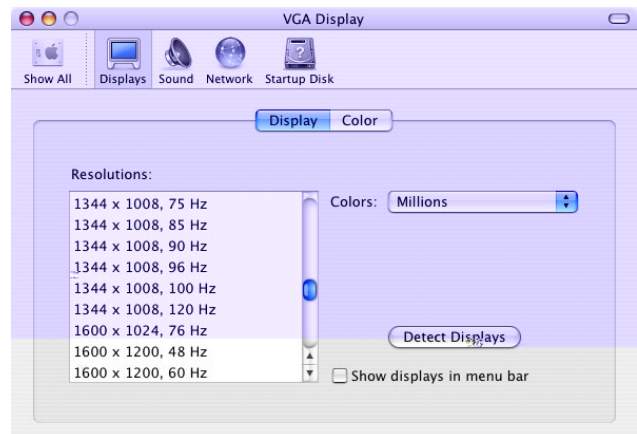

- Select a screen mode according to the aspect ratio corresponding to the selected resolution (4:3 for 1400 by 1050 dots). (P33)
- If the display resolution of the computer is set to SXGA (1280 by 1024 dots) or WXGA (1360 by 768 dots), select [True size] as the screen mode.

# Starting Projector

## Connecting the Power Cord

Before connecting the power cord

### Buttons Used Here

Remote control

Top

Connect the power cord and turn on the projector.

**Insert the power cord plug into the power cord connection socket.**

Be sure to insert the power cord as far as it will go.

**Insert the power plug.**

The [POWER] indicator flashes red. It stays lit when the projector is ready for power-on operation.

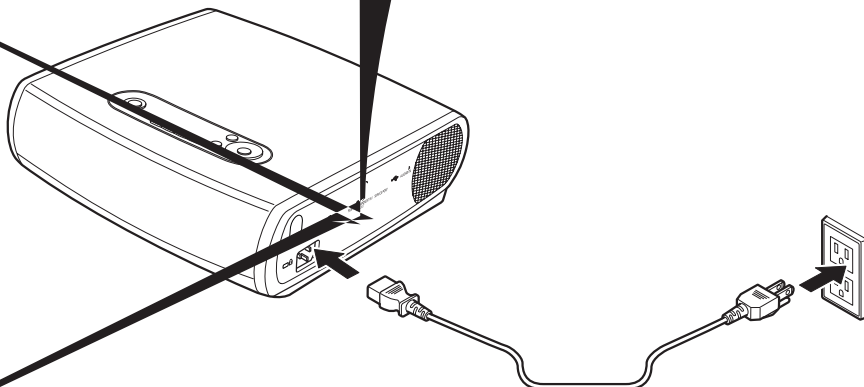



Caution

Connect the ground terminal of the power plug to the ground level in order to use the projector safely. Otherwise, the operating computer may cause electromagnetic radiation problems and poor reception by TV and radio.

### Unplug the Power Cord When the Projector is Not in Use

The projector constantly consumes about 6W power even when the Power button is turned off. To ensure safety and power saving, remove the power plug from the AC outlet when the projector is not used for an extended period of time.

## Turning On the Projector



Once the projector is turned off, it cannot be turned on for about 60 seconds. Wait until the lamp cooling period ends and the [POWER] indicator lights red.

1

**Make sure that the [POWER] indicator lights red.**

2

**Press the [POWER] button.**

The [POWER] indicator first blinks green and then turns lit green.

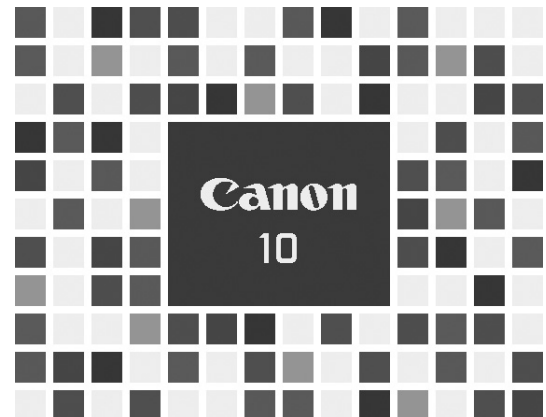
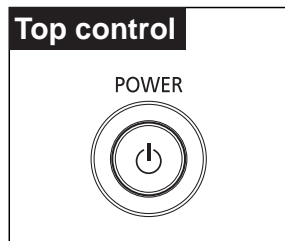
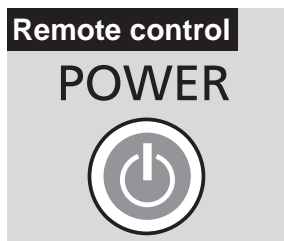

The Opening window is displayed for about 20 seconds and the along with the countdown timer.

To project an image immediately, press the [OK] button.



- Canceling the Countdown Function Performed at the Start ( P61)
- Displaying a Unique Logo on the Opening Screen (P59, 60)
- If a password entry screen appears, enter the password. (P71)

## 3

**Select a video terminal of the computer.**

To input images from the DVI-I/RGB IN-1 terminal, select the [COMPUTER-1] button. To input images from the RGB IN-2/COMPONENT/RGB OUT terminal, select the [COMPUTER-2] button.

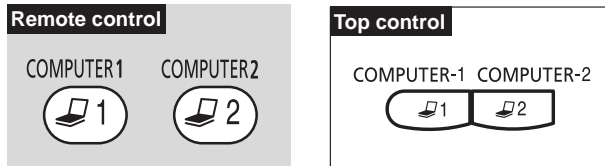

## 4

**Select a signal type.**

If images are not displayed correctly, press the button mentioned in step 3 repeatedly to select a desired input type. Pressing the [COMPUTER-1] button repeatedly allows you to select DIGITAL RGB and ANALOG RGB-1 alternately. Pressing the [COMPUTER-2] button repeatedly allows you to toggle between ANALOG RGB-2 and COMPONENT.

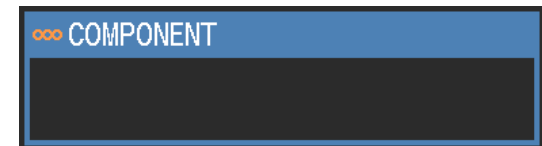
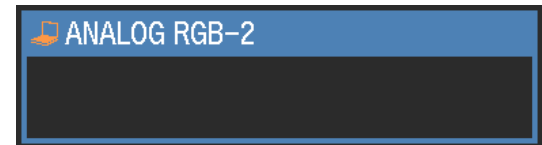
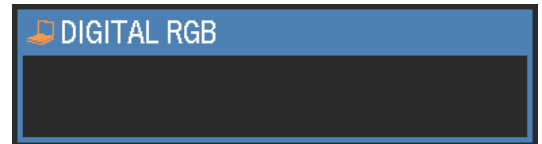

## Using the Auto PC Adjustment Function

This projector automatically selects a signal type (VGA, SVGA, XGA, SXGA, SXGA+, etc.) and makes optimum settings for the total number of dots and tracking depending on the connected computer (auto PC adjustment). (This function cannot be used when digital RGB is selected.)

When you switched to the computer mode using the [COMPUTER-1] or [COMPUTER-2] button, press the [AUTO PC] button. The auto PC adjustment becomes active to display images correctly.



For some computers, the auto PC adjustment does not work. In this case, you need to make settings (total dots, tracking, horizontal/vertical positions, horizontal/vertical pixels, etc.) for the input signal.



- The last used signal types are recorded for the [COMPUTER-1] and [COMPUTER-2] buttons respectively. When the projector is connected to the same computer, it can be used with the same settings as before simply by switching to the computer mode.
- For the settings for the input signal, refer to P52 to 57.

# Adjusting the Image

## Buttons Used Here

Remote control

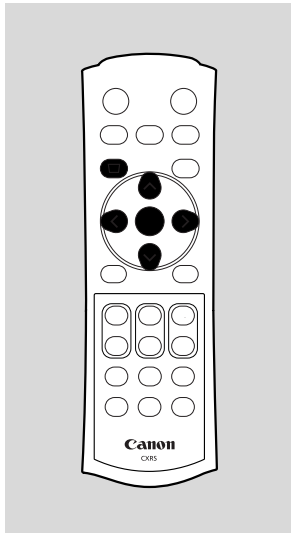

Top control

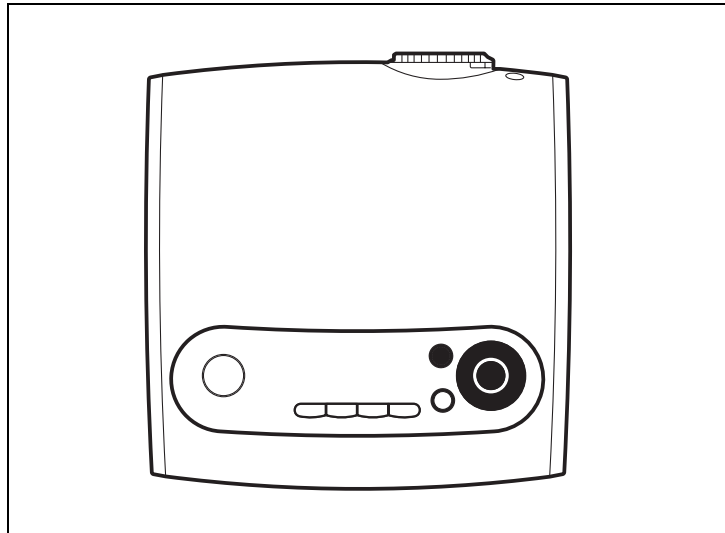

## Adjusting the Image Size

Move the Zoom lever to adjust the image size.

- If your desired image size is too large or small to adjust with the Zoom lever, change the projector installation position.

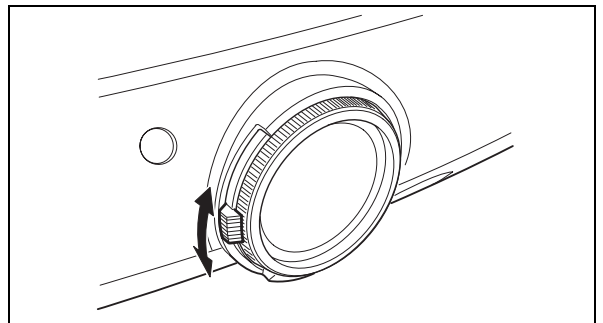

## Adjusting the Focus

Turn the Focus ring to the position where the projected image looks sharpest.

- If the projection distance is outside the range from about 1.2 m (3.9') to 9.1 m (29.9'), focus adjustment may be impossible. Adjust the projection distance.

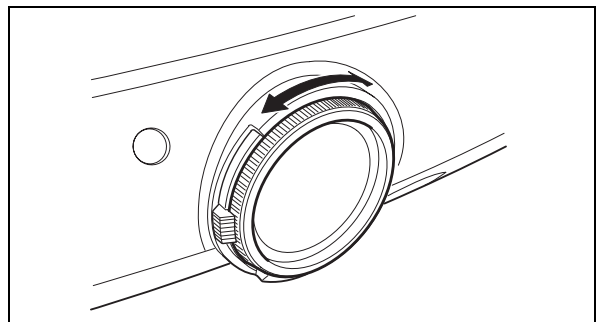

# Adjusting Keystone Distortion

If a projected picture has keystone distortion, correct it by using the keystone adjustment feature.

1

## Select Keystone Adjustment.

“Keystone adjustment” appears on the screen.

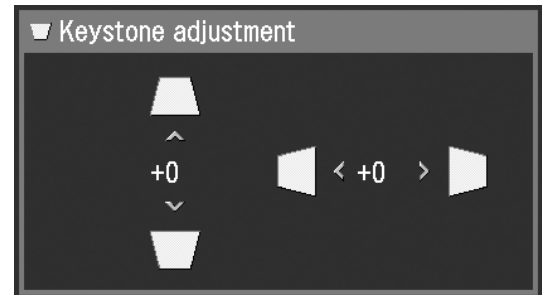
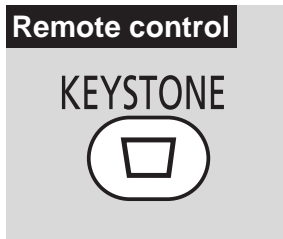

2

## Correct keystone distortion.

Keystone distortion must be corrected while “Keystone adjustment” is displayed on the screen. (“Keystone adjustment” disappears 10 seconds later.)

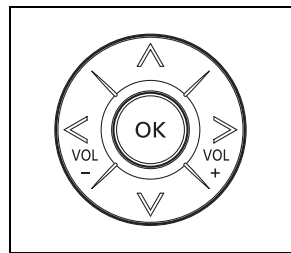
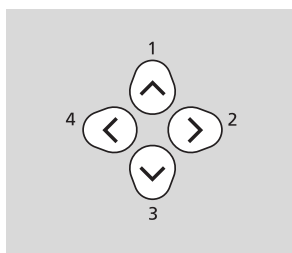

To reduce the length of the upper edge, press [^].

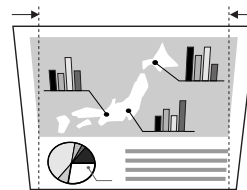

To reduce the length of the lower edge, press [v].

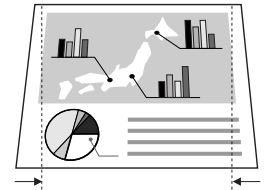

To reduce the length of the left edge, press [<].

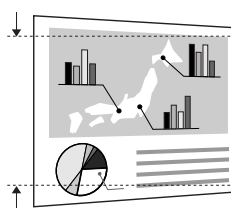

To reduce the length of the right edge, press [>].

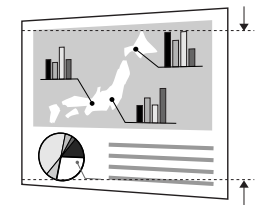

3

## Press the [OK] button.

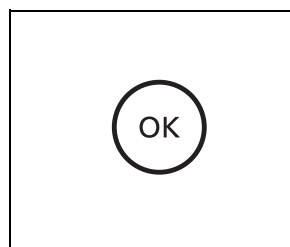
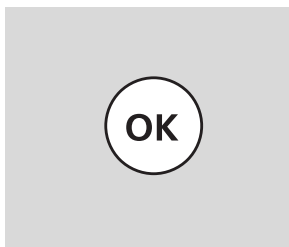



- The result of keystone adjustment is memorized. If the projector installation position is the same as before, keystone adjustment is not required.
- When Keystone Adjustment is selected, signals are processed digitally. The image may look different from the original one.
- The aspect ratio of the image may change when keystone is adjusted.
- Keystone can be adjusted vertically and horizontally within the range of +/-20 degrees. The amount of adjustment varies depending on the combination of the amount of optical zooming, input signal type, and adjustment direction (vertical or horizontal).
- If the keystone distortion is too large to adjust, move the projector installation position.
- To cancel the keystone adjustment, press the [KEYSTONE] button again to display [Keystone Reset]. Then, press the [OK] button.



## Selecting a Screen Mode

You can select one of four screen modes depending on the display resolution of your computer.

- A screen mode can be selected by selecting “Screen settings” from the menu. (P57)

### Full screen

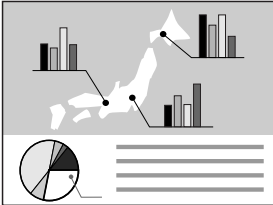

Select this to project an image displayed on the computer screen at a 4:3 aspect ratio (W:H) (SXGA+ [1400 by 1050 dots] or XGA [1024 by 768 dots]).

The image displayed on the computer screen at a 5:4 (W:H) aspect ratio is projected with it compressed vertically or horizontally.

### Normal

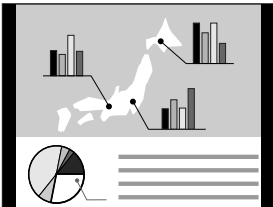

Select this to project an image displayed on the computer screen at a 5:4 (W:H) aspect ratio (SXGA) or on a wide screen of Macintosh. Since the image is projected with it fitted to either the width or length of the computer screen, the top and bottom portions or the leftmost and rightmost portions of the image are missing.

### Wide Screen

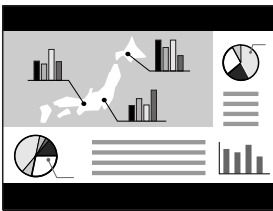

Select this to project an image displayed on the computer screen at a 16:9 (W:H) aspect ratio.

Since the image is projected with it fitted to the width of the computer screen, the top and bottom portions of the image are missing.

### True size



Select this if you want to project an image in its original size.

A clear image can be obtained because of no image processing.

This mode cannot be selected when the display resolution of the computer is larger than 1400 by 1050 pixels.



- If the display resolution of the computer is higher than 1400 by 1050 dots, select a lower resolution before starting projection.
- The upper, lower, left, and/or right portions of a projected image may be missing depending on the selected display mode.

## Selecting an Image Mode (Quality)

You can select one of four image modes. You can adjust the image quality (brightness, contrast, sharpness, gamma, color) as you like.

**1** Press the [IMAGE] button.



"IMAGE" appears on the screen, allowing you to select a desired image mode by pressing the [IMAGE] button repeatedly.

- [Standard]** Select this to project an image with a similar quality to that of the original image. An image is projected with a high regard for reproduction of white.
- [Presentation]** Select this to project an image with a similar quality to that of the original image. A bright and high-contrast image is projected.
- [Cinema]** Select this to project a moving picture. A picture is projected with a high regard for color tone reproduction.
- [sRGB]** Select this when you want to project an image from a sRGB-compatible digital camera. An image is projected in the display mode conforming to the sRGB Standard.



- The quality of the image projected in each image mode can be adjusted as follows. For the adjustment method, refer to "Image Adj. Menu." (P62)
  - Brightness Adjust this when the image is too bright or dark.
  - Contrast Adjust this to decrease or increase contrast of the entire image.
  - Sharpness Adjust this to soften or sharpen an image.
  - Gamma/Dynamic gamma Adjust this to obtain better balance of contrast.
  - Screen color correction/Advanced color adjustment Adjust this when color tones are different from those of the original image.
- The results of adjustments made by the user are saved for each of six types of input signals. Once they are saved, images can be projected with the same settings.
- An image mode can be selected by selecting "Image adj." from the menu. (P49, 62)

# Turning Off the Projector

- Turning off the projector again with the lamp in an unstable state shortly after turning on the projector may shorten the lamp life. Wait at least 5 minutes before turning off the projector again.
- Remove the AC power cord after the [POWER] indicator lights red after power-off. Removing the AC power cord immediately can damage the lamp and circuits.
- Using the projector for more than 24 hours continuously may shorten the life of the lamp and internal optical components. Turn off the projector at least once in 24 hours and give it a rest for about one hour.

 When the power is turned off, cooling of the lamp starts. Therefore, the projector cannot be turned on again for about 90 seconds.

1

**Press the [POWER] button.**

A confirmation message appears on the screen.

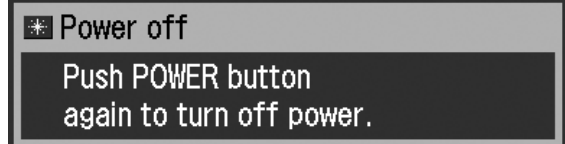
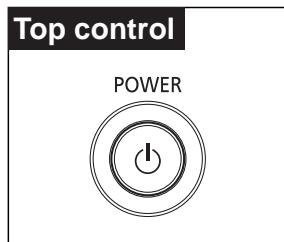
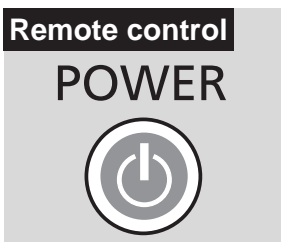

To continue projection, wait until the confirmation message disappears (about 4 seconds) or press a button other than the [POWER] button.

2

**Press the [POWER] button again while the confirmation message is displayed.**

The POWER indicator goes out and starts flashing red, starting to cool the lamp.

3

When the [POWER] indicator lights red in 90 seconds, remove the power cord from the AC outlet.

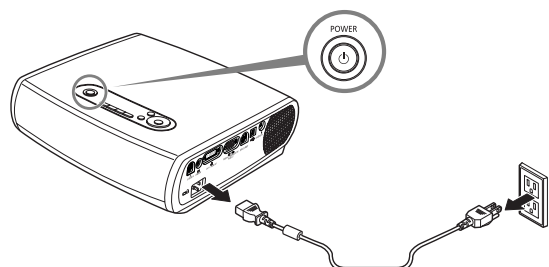

# Setting up the Power Management Function

If the projector receives no signal input within 30 seconds, a countdown timer appears. The lamp will turn off five minutes later and the projector will enter the power management mode selected in advance.

You can select one of the following power management modes from the menu. (P70)

## Ready mode

Select this mode to start projection immediately.

When the projector enters this mode, the lamp is turned off and its cooling starts. When the lamp has been cooled down, the [POWER] indicator starts flashing red and green to enter the ready status. Projection will restart if the input signal is reconnected or any button on the top control or remote control is pressed.

## Shutdown mode

Select this mode to turn off the projector automatically.

When the projector enters this mode, the lamp is turned off and its cooling starts. When the lamp has been cooled down, the [POWER] indicator stops flashing red and stays lit and the power is turned off.



When the lamp is being cooled in a power management mode (for 90 seconds), the projector is inoperative.



The power management function can be disabled (OFF).

# USEFUL FUNCTIONS AVAILABLE DURING PROJECTION

Let's take a look at the useful functions available when you make a presentation with a computer connected to the projector.

**Blacking Out an Image Temporarily**  
[NO SHOW] ..... P37

**Making an Image Larger/Smaller**  
[D.ZOOM] ..... P38

**Showing the Elapsed Time**  
[P-TIMER] ..... P39

**Pointing to a Position with a Spotlight**  
[SPOT] ..... P39

**Freezing a Image**  
[FREEZE] ..... P40

**Muting the Sound/Adjusting the Volume**  
[MUTE/VOL] ..... P40

**Operating the Mouse Using the Remote Control** ..... P41

## Blacking Out an Image Temporarily

[NO SHOW]

**Useful when:**

- You finished the presentation.
- You want to divert attendees' attention from the screen.

Black out the image temporarily.

### Blacking out an Image

Remote control

NO SHOW



The screen changes to black or blue.

### Showing the Image Again

NO SHOW



- A unique logo can be captured. (P59)
- The company logo can be shown while the image is blacked out. (P60)





## Showing the Elapsed Time

[P-TIMER]

### Useful when:

- You want to manage the proceedings of the presentation.

The timer indicating the elapsed time (00:00 to 59:59) is shown in the lower right corner just like the stopwatch.

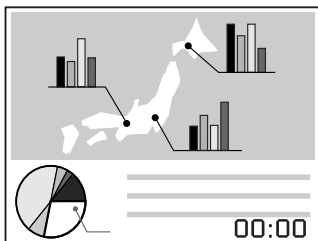

### Starting the Timer

Remote control

P-TIMER



Pressing this button once shows the timer and starts the timer.

### Stopping the Timer

P-TIMER



Pressing this button once again stops the timer.

### Canceling the P-TIMER function

P-TIMER



When you pressing this button once again, the timer disappears.

## Indicating a Position with a Spotlight

[SPOT]

### Useful when:

- You point to a portion of an image that should draw attendees' attention.

Point to a desired portion of the projected image with a pointer.

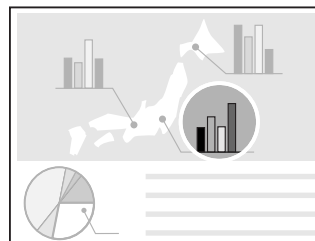

### Showing the Pointer

Remote control

SPOT



A pointer appears at the center of the screen and the image becomes dark excepting the pointer.

Multiple types of pointers are supported and you can select a desired pointer by pressing the [SPOT] button repeatedly.

### Moving the Pointer

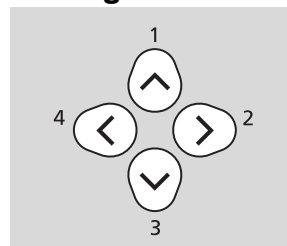

Move the pointer to a desired position.

To cancel the SPOT function, press the [OK] button.

The normal screen appears.

## Freezing the Picture

[FREEZE]

### Useful when:

- You want to perform a computer operation which is irrelevant to the proceedings of the presentation.
- You want to stop a moving image.

Freeze the moving image.

### Freezing an Image

Remote control

FREEZE



“FREEZE” icon is shown on the screen.

### Canceling the FREEZE function

FREEZE



To cancel the FREEZE function, press this button again.



The frozen image can be expanded or compressed.

## Muting the Sound/ Adjusting the Volume

[MUTE]

### Useful when:

- You want to mute the sound from the projector immediately.
- You want to adjust the volume level of the projector speaker.

Mute the sound temporarily or adjust the volume level.

### Muting the Sound

Remote control

MUTE



“MUTE” icon is shown on the screen.

### Canceling the MUTE function

MUTE



To cancel the MUTE function, press this button again.

Pressing the [VOL +/-] button also cancels the MUTE function.

### Adjusting the Volume

Remote control



Top control



Pressing the [+] / [-] button shows a Volume bar appears on the screen. (If the volume is not adjusted with the [+] / [-] button in about 4 seconds, the Volume bar disappears.)



The MUTE function can be used from both the remote control and top control.



## Operating the Mouse Using the Remote Control

### Useful when:

- You want to use the supplied remote control as the wireless mouse of the personal computer.

### Connecting the USB Cable

Make sure that both the computer and projector are turned off. Connect the supplied USB cable between the USB terminal on the computer and the USB terminal on the projector.

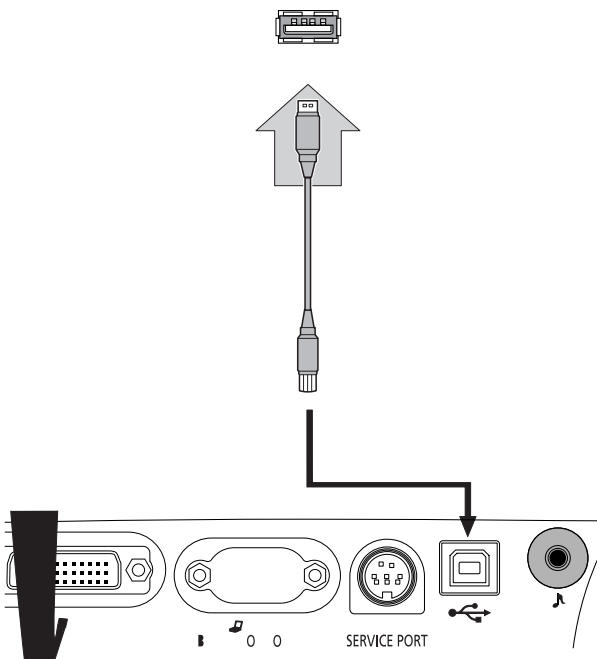

This function is available on Windows XP, Windows 2000, Windows Me, or Mac OS 9.2 and later.

# PROJECTING AN IMAGE FROM AV EQUIPMENT

## Connecting the Projector to AV Equipment

Connect the projector and AV equipment.

### Connecting to Video Terminals

Before connecting cables, turn off both the projector and computer.  
\*ART terminal is not supported.

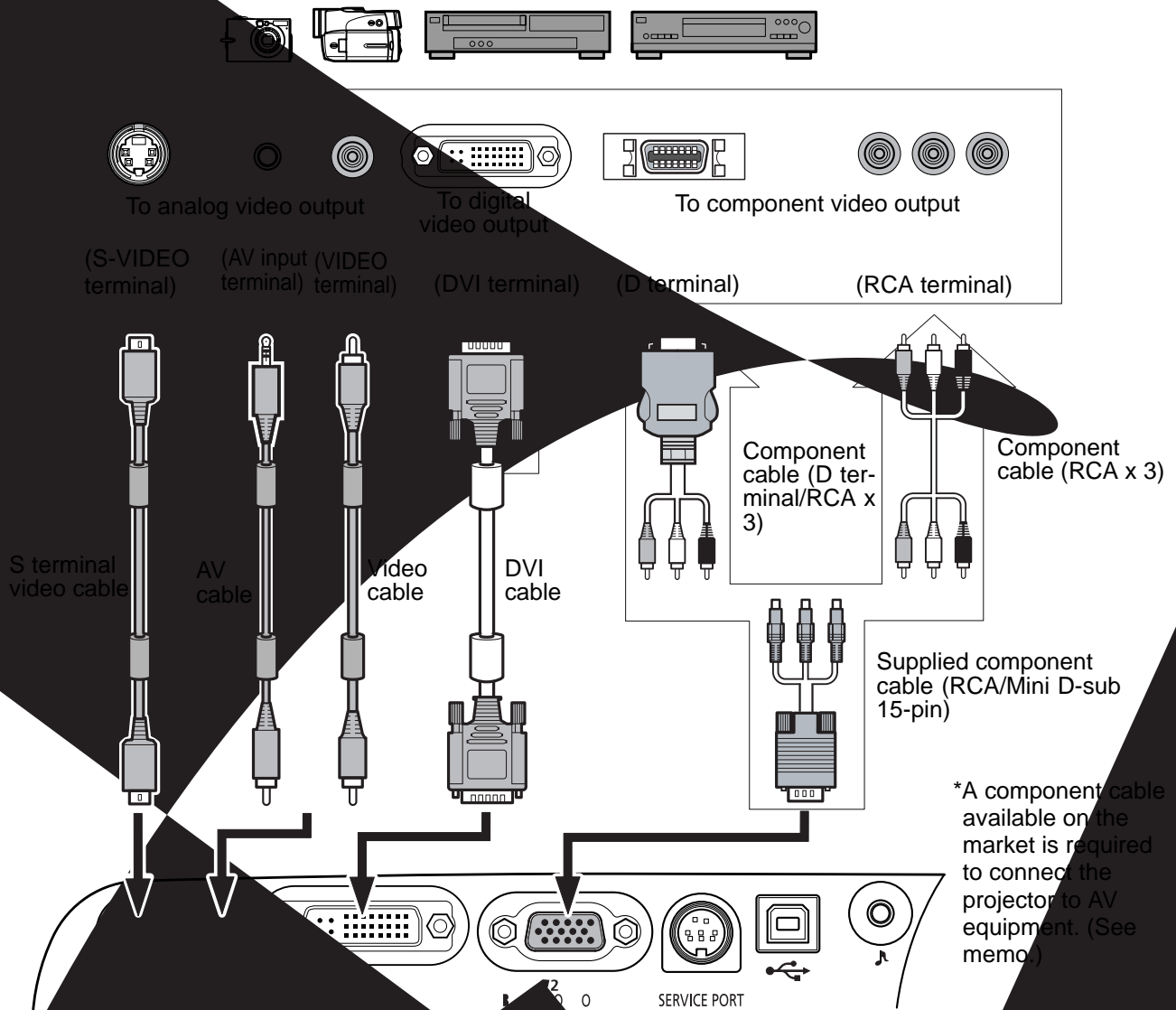

\*A component cable available on the market is required to connect the projector to AV equipment. (See memo.)

### About the Component Cable

The projector cannot be connected to AV equipment using only the supplied component cable (RCA/Mini D-sub 15-pin). Purchase either of the following cables according to the type of the terminal on the AV equipment:

- RCA terminal: RCA x 3/RCA x 3
- D-terminal: D-terminal/ RCA x 3

PROJECTING AN IMAGE FROM AV EQUIPMENT

## Connecting to Audio Terminals

Connect audio cables as required.

 Before connecting cables, turn off both the projector and computer.

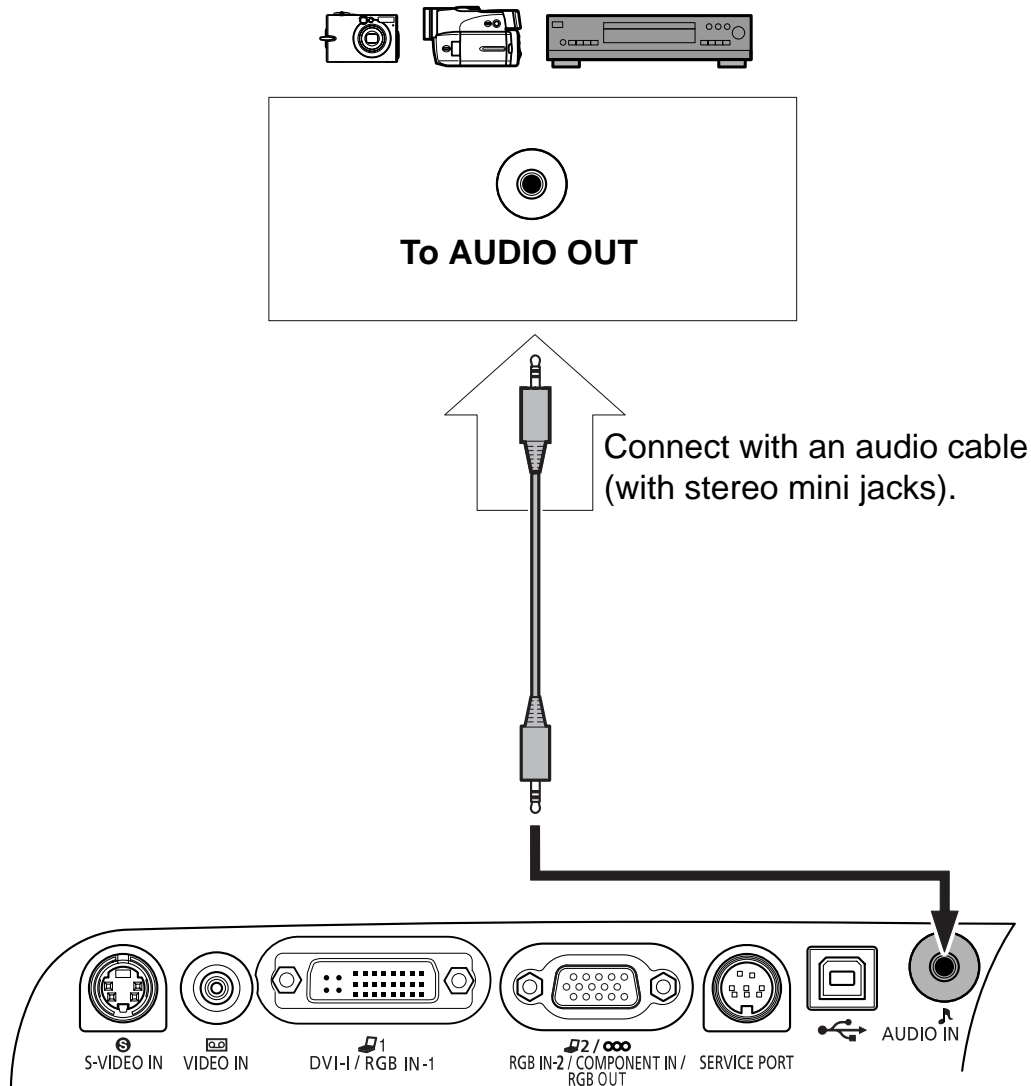

- Use an audio cable without a built-in resistor. Using an audio cable with a built-in resistor turns down the sound.
- The built-in speaker is monaural.
- The speaker issues the sound from the equipment to which an audio cable is connected.

# Starting Projection

Connect the power cord and turn on the projector.

- Before connecting the power cord, connect the projector to the AV equipment.
- Once the projector is turned off, it cannot be turned on for about 90 seconds. Wait until the lamp cooling period ends and the [POWER] indicator lights red.

 The projection method is basically the same as that used when the projector is connected to a computer. (P23) Lets take a look at only the topics specific to AV equipment.

## Buttons Used Here

Remote control

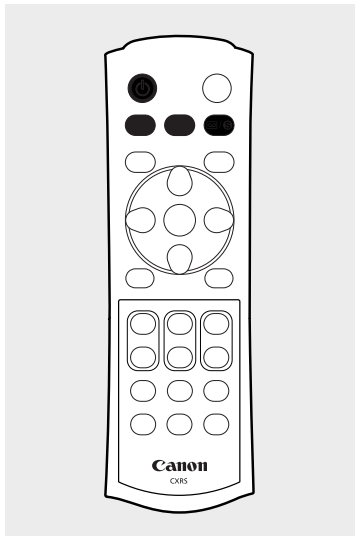

Top control

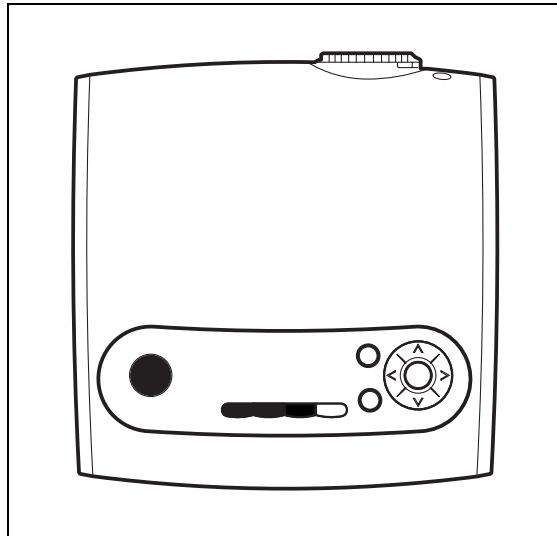

**Connect the power cord.**

**Make sure that the [POWER] indicator lights red.**

**Press the [POWER] button.**

The [POWER] indicator first blinks green and then turns lit green.

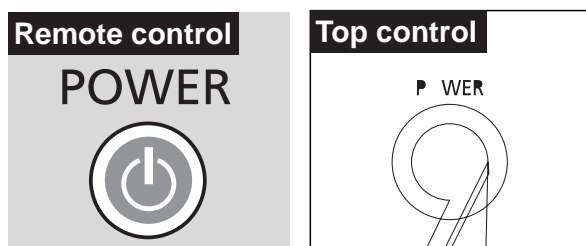

The Opening window is displayed for about 20 seconds along with the countdown timer.



- Canceling the Countdown Function Performed at the Start (61)
- Displaying a Unique Logo on the Opening Screen (59, 60)
- If a password entry screen appears, enter the password. (71)
- To project an image immediately, press the [OK] button.

# 4

## Select an AV terminal.

To input images from the DVI-I/RGB IN-1 terminal, select the [COMPUTER-1] button.

To input images from the RGB IN-2/COMPONENT/RGB OUT terminal, select the [COMPUTER-2] button.

To input image from the S-VIDEO IN terminal or VIDEO IN terminal, press the [VIDEO/S] button.

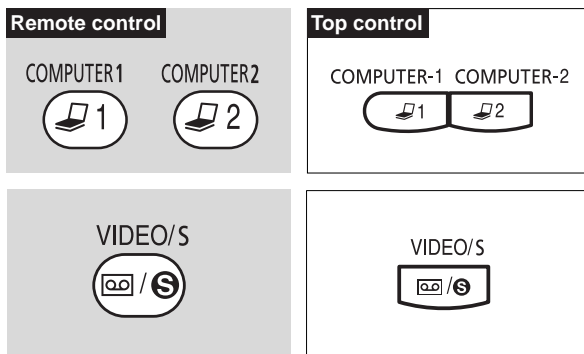

## 5 Select a signal type.

If images are not displayed correctly, press the button mentioned in step 4 repeatedly to select a desired input type.

Pressing the [COMPUTER-1] button repeatedly allows you to select DIGITAL RGB and ANALOG RGB-1 alternately.

Pressing the [COMPUTER-2] button repeatedly allows you to toggle between ANALOG RGB-2 and COMPONENT.

Pressing the [VIDEO/S] button repeatedly allows you to toggle between VIDEO and S-VIDEO.

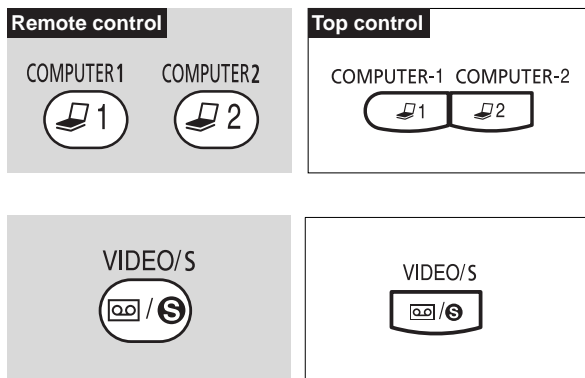

- This projector cannot project digital contents copy-protected by the HDCP technology.
- For the input signal selection method, refer to 56 and 57.

## 6 Play the AV equipment.

The image from the AV equipment appears.

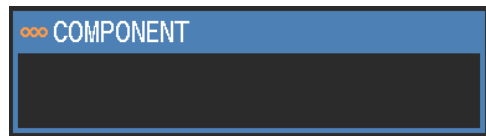
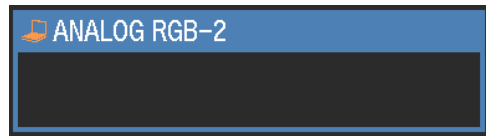

# Adjusting the Image

The image adjustment method is the same as that used when the projector is connected to a computer. Lets take a look at only the topics specific to AV equipment.

For other image adjustment methods, see P30.

## Selecting a Screen Mode

You can select one of three screen modes depending on your AV equipment, specifications of playback software, etc.

- A screen mode can be selected by selecting “Screen settings” from the menu. (58)

### ■ Normal (VIDEO, S-VIDEO and COMPONENT input only)

Select this if you want to project an image at a 4:3 aspect ratio (W:H).

4:3



### ■ Wide Screen (VIDEO, S-VIDEO and COMPONENT input only)

Select this if you want to project an image at a 16:9 aspect ratio (W:H).

16:9



For wide screen sizes, see the table on 85.

### ■ Auto (COMPONENT input only)

To switch between [Normal] and [Wide Screen] automatically depending on the image from the AV equipment, select [Auto].



- The upper, lower, left, and/or right portions of a projected image may be missing depending on the selected display mode
- When DIGITAL RGB or ANALOG RGB-1 is selected as the input signal type, the display mode is the same as that used when the projector is connected to the computer. (P33)



# SETTING UP FUNCTIONS USING MENUS

## Using Menus

Windows shown on the projector screen to allow you to set up the projector are called menus.

This projector supports the following three menus:

### Display Setting Menu

This menu is used to set input signals of the computer and AV equipment and make various settings related to display.

### Image Adjustment Menu

This menu is used to make various adjustments to the projected image.

### System Setting Menu

This menu is used to set various functions of the projector.

First, we will explain the typical procedure for handling menus. Next, we will give a detailed description of menu items.

## Symbols Indicating Item Categories

Menu items are classified into two categories, menu items used to project the image from the computer and menu items used to project the image from the AV equipment.



Menu item used when projecting an image from the computer.



Menu item used when projecting an image from AV equipment.

**D-RGB**

DIGITAL RGB input

**Component**

COMPONENT input

**A-RGB**

ANALOG RGB-1/-2 input

**Video/S-video**

VIDEO input/S-VIDEO input

**Press the [MENU] button.**

A menu window appears.

- To close the menu window, press the [MENU] button again.

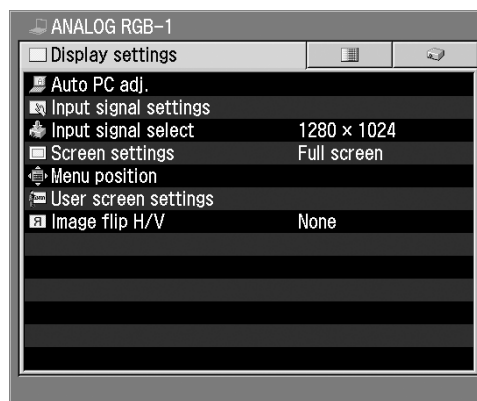
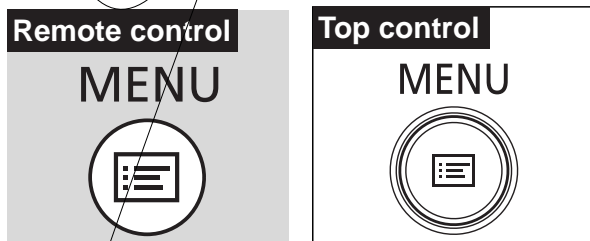

**Select the tab containing the item you want to set.**

Select the [Display settings], [Image Adj.], or [System settings] tab.

- The selected tab contains the items handled previously. To select another tab, press the [^] button repeatedly.

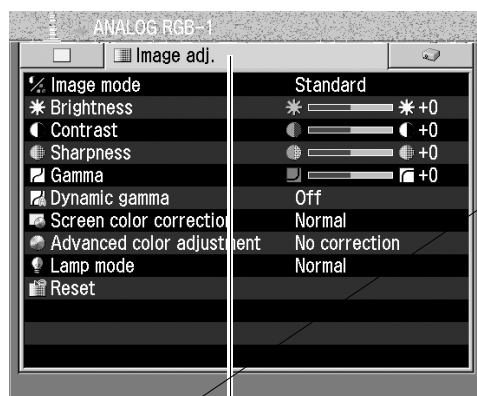

Selected item is highlighted in orange.

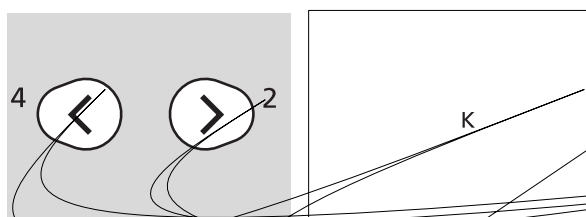

**Select the item you want to set.**



**Make a setting.**

Make an adjustment or choice. Select an item from the menu, make an adjustment using the slide bar, or make a setting in a different window according to the purpose of setting.

**Press the [OK] button.**

The setting takes effect.

Some menu items take effect at the time they are selected and some take effect when the [OK] button is pressed.

**When you finished setting the selected item, press the [MENU] button.**

The menu disappears.

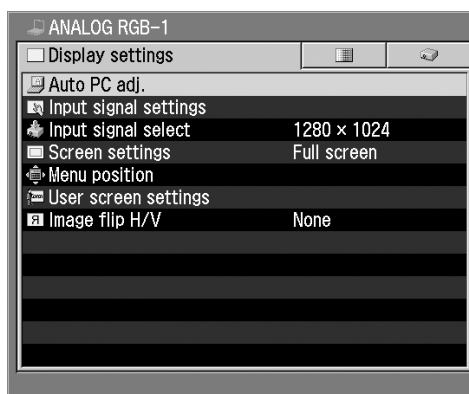

**Selecting from the Menu**  
(Example: Screen setup)

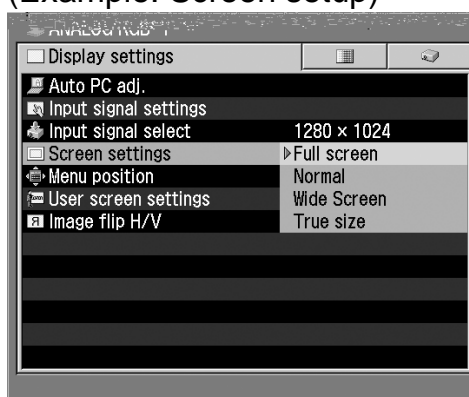

**Making an Adjustment Using the Slide Bar**

(Example : Adjustment of Contrast)

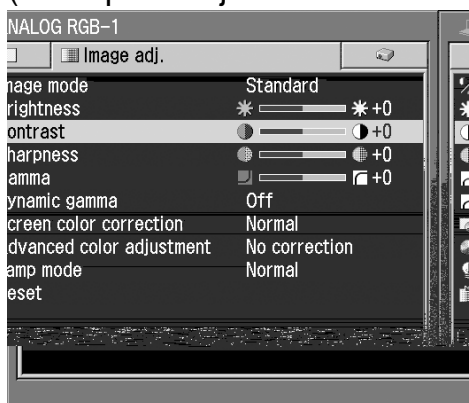

**Making a Setting in a Different Window**

(Example : Registration of User Logo)

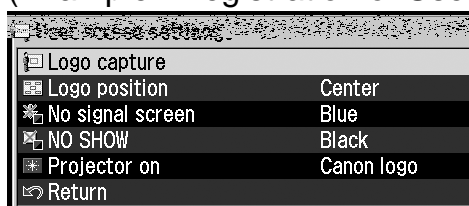

# Display Settings Menu

Make various settings related to input signals of the computer and AV equipment as well as the settings related to display.

|   |                                    |
|---|------------------------------------|
| Performing the auto pc adjustment           | [Auto pc adj.]..... P52            |
| Adjusting the total number of dots          | [Total dots]..... P53              |
| Adjusting the tracking                      | [Tracking] ..... P53               |
| Adjusting the horizontal position           | [Horizontal position] ..... P54    |
| Adjusting the vertical position             | [Vertical position] ..... P54      |
| Adjusting the number of horizontal pixels   | [Horizontal pixels] ..... P55      |
| Adjusting the number of vertical pixels     | [Vertical pixels] ..... P55        |
| Selecting an input signal type              | [Input signal select] .... P56, 57 |
| Selecting a Screen mode                     | [Screen settings] ..... P57, 58    |
| Selecting a menu position                   | [Menu position]..... P58           |
| Capturing a logo to be displayed            | [Logo capture] ..... P59           |
| Selecting a logo display position           | [Logo position]..... P59           |
| Displaying a logo (No signal input)         | [No signal screen] ..... P60       |
| Displaying a logo (No Show)                 | [No show screen] ..... P60         |
| Displaying a logo (Projector on)            | [Projector on]..... P61            |
| When Ceiling-mounted or for Rear Projection | [Image flip H/V] ..... P61         |

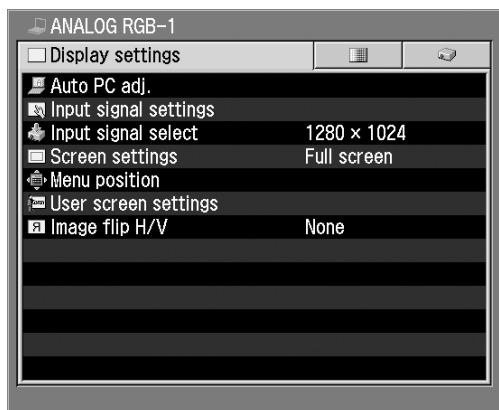

## Performing the Auto PC Adjustment

A-RGB

The projector automatically detects the input signal (ANALOG RGB) from the connected computer to make the optimum settings for the total number of dots, tracking, and so on.

Display settings

Auto PC Adj.

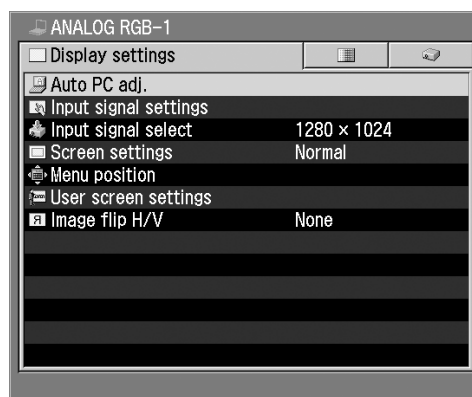

OK

Perform the auto PC adjustment function.



- Most computers can project an image optimally using an auto PC function.
- Signal types supported by the computers that can use the auto PC function are listed in the table on page 84.
- If an image cannot be projected correctly even with the auto PC function, manually specify the parameters ([Total dots] to [Vertical pixels]) for the next item [Input signal settings]. (P53 to P55)

## Adjusting the Total Number of Dots



A-RGB

Adjust the total number of horizontal dots.

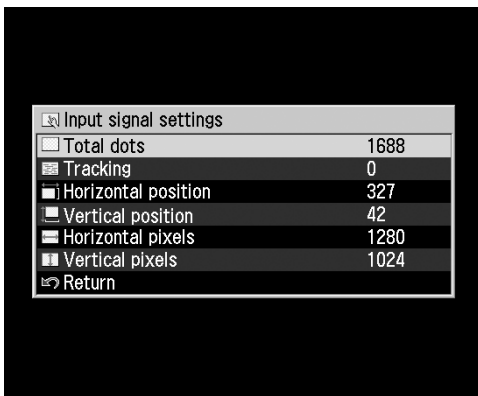
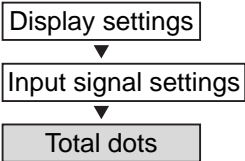

- > Increase the total number of dots.
- < Reduce the total number of dots.

This adjustment is required when the auto PC adjustment cannot project images correctly.

## Adjusting the Tracking



A-RGB

Adjust the tracking when the projected image flickers due to a tracking error.

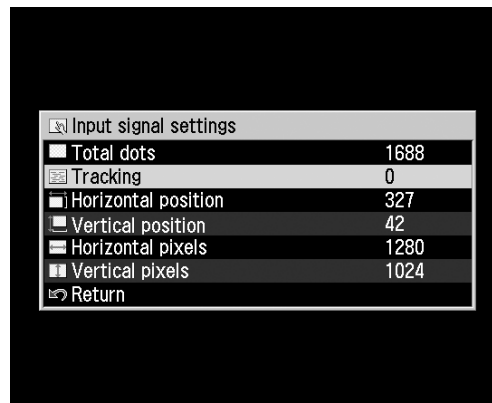
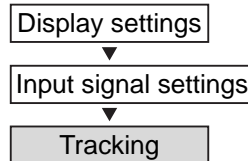

- > Increases the set value.
- < Decreases the set value.

This adjustment is required when the auto PC adjustment cannot project images correctly.

- The setting is recorded for the [ANALOG RGB-1] signal and [ANALOG RGB-2] signal separately.

## Adjusting the Horizontal Position



A-RGB

Adjust the horizontal position of the screen when the projected image is shifted horizontally.

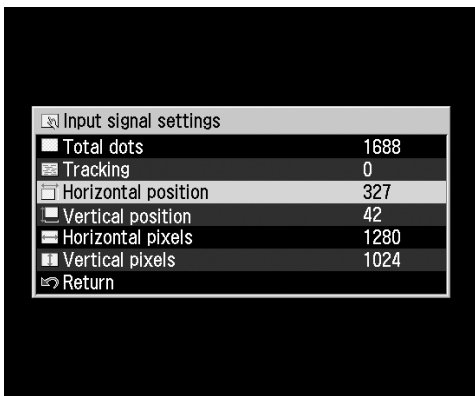
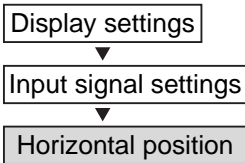

- > Moves the screen to the right.
- < Moves the screen to the left.



- This adjustment is required when the auto PC adjustment cannot project images correctly.
- The setting is recorded for the [ANALOG RGB-1] signal and [ANALOG RGB-2] signal separately.

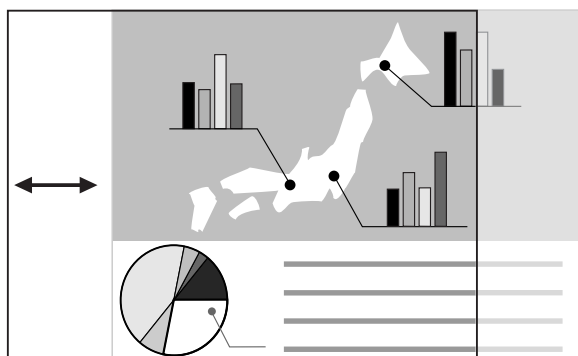

## Adjusting the Vertical Position



A-RGB

Adjust the vertical position of the screen when the projected image is shifted vertically.

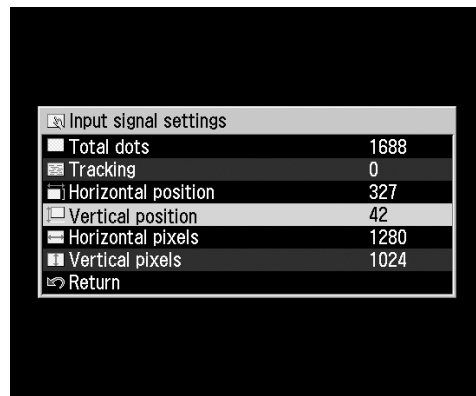
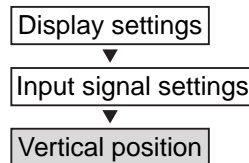

- > Moves the screen up.
- < Moves the screen down.



- This adjustment is required when the auto PC adjustment cannot project images correctly.
- The setting is recorded for the [ANALOG RGB-1] signal and [ANALOG RGB-2] signal separately.

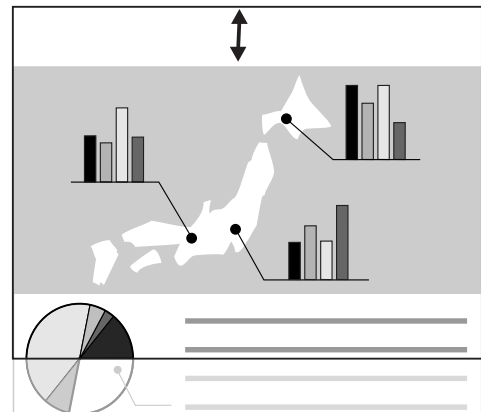

## Adjusting the Number of Horizontal Pixels



A-RGB

When the horizontal size of the screen is too large or small, adjust it to the screen size.

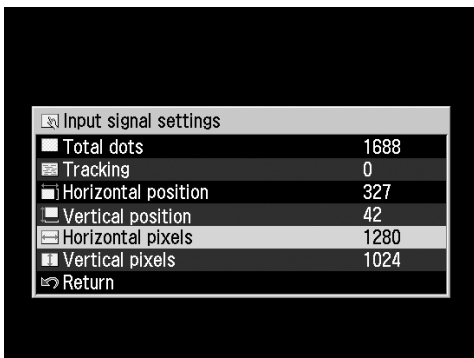
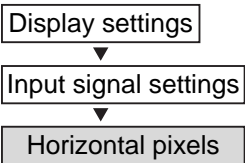

- > Increase the number of horizontal pixels.
- < Decrease the number of horizontal pixels.

- This adjustment is required when the auto PC adjustment cannot project images correctly.
- The setting is recorded for the [ANALOG RGB-1] signal and [ANALOG RGB-2] signal separately.

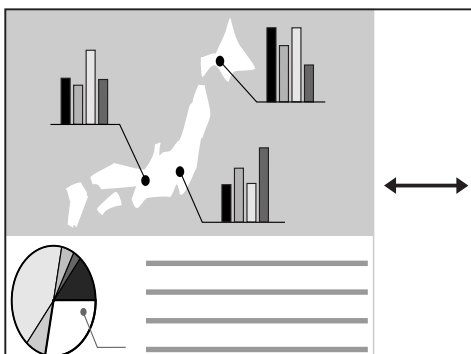

## Adjusting the Number of Vertical Pixels



A-RGB

When the vertical size of the screen is too large or small, adjust it to the screen size.

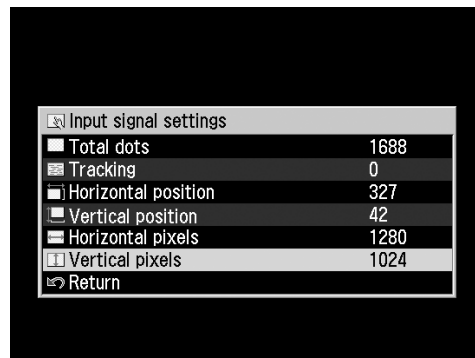
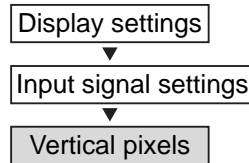

- > Increase the number of horizontal pixels.
- < Decrease the number of horizontal pixels.

- This adjustment is required when the auto PC adjustment cannot project images correctly.
- The setting is recorded for the [ANALOG RGB-1] signal and [ANALOG RGB-2] signal separately.

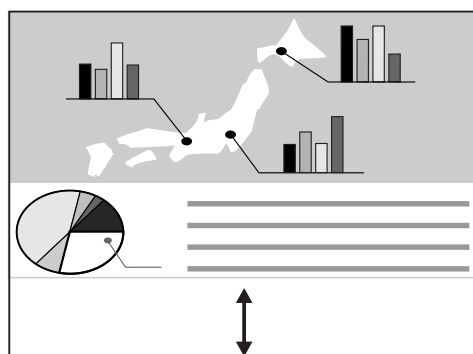

## Selecting an Input Signal Type (1)



A-RGB

When two or more types of input signals are found during execution of the auto PC adjustment function, select a correct input signal type.

Display settings

Input signal select

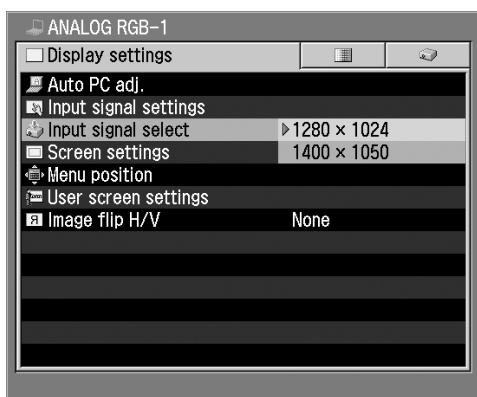

[1280 x 1024]  
[1400 x 1050]  
⋮

Select an input signal type suitable for the computer from the displayed signal types.



- Select an input signal type when the auto PC adjustment function cannot project images correctly and two or more signal types are found.
- For the signal types supported by this projector, see P84.

## Selecting an Input Signal Type (2)



Video/S-video

When images from AV equipment is not projected correctly (irregular color or no image), you can select an input signal type manually.

Display settings

Input signal select

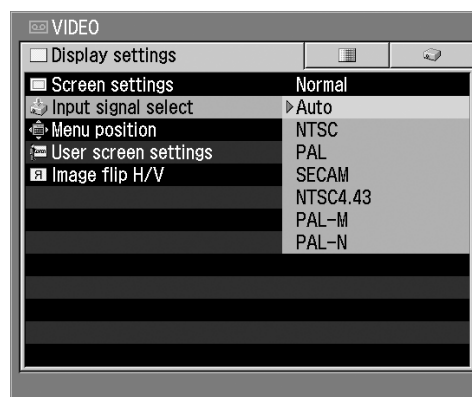

Auto  
NTSC  
PAL  
SECAM  
NTSC4.43  
PAL-M  
PAL-N

The input signal is automatically set. If images are not projected correctly in the Auto mode, select one of input signal types shown on the left.



Confirm the input signal type according to the User's Manual that came with the AV equipment connected.



## Selecting an Input Signal Type (3)



Component

When images from AV equipment is not projected correctly, you can select an input signal type manually.

Display settings

Input signal select

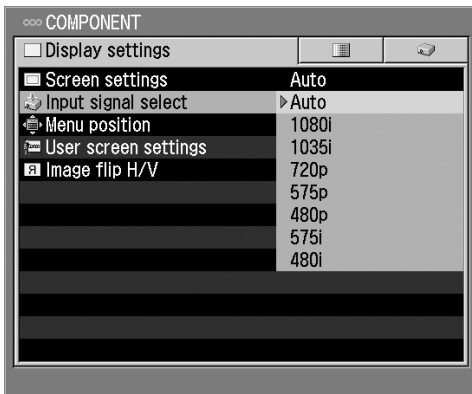

Auto

The video format is automatically set according to the input signal.

1080i

If images are not projected correctly in the Auto mode, select one of input signal types shown on the left.

1035i

720p

575p

480p

575i

480i



Confirm the input signal type according to the User's Manual that came with the AV equipment connected.

## Selecting a Screen Mode (1)



A-RGB D-RGB

When the projected image size is larger/smaller than the screen size.

Display settings

Screen settings

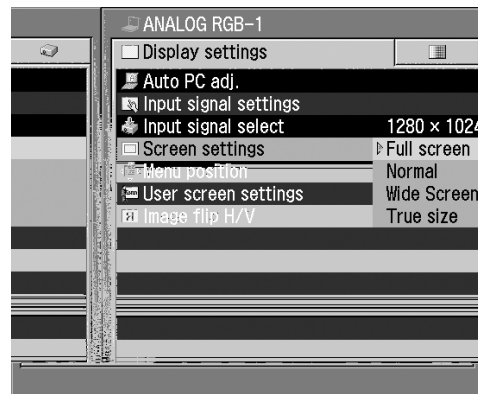

Full screen

An image from the computer is projected fully on the screen.

Normal

An image is projected in the maximum size with the aspect ratio unchanged.

Wide Screen

An image is projected at 16:9 aspect ratio with its width matching to the width of the screen.

True size

An image is projected in its original size (no enlargement/reduction).



- Set the display resolution of the computer to 1400 x 1050 dots or lower.
- When Full screen is selected, circles may become out of round depending on the display resolution of the computer.
- The upper, lower, left, and/or right portions of a projected image may be missing depending on the selected display mode.

## Selecting a Screen Mode (2)

Video/S-video Component



Select a screen mode according to the size of the image to be projected.

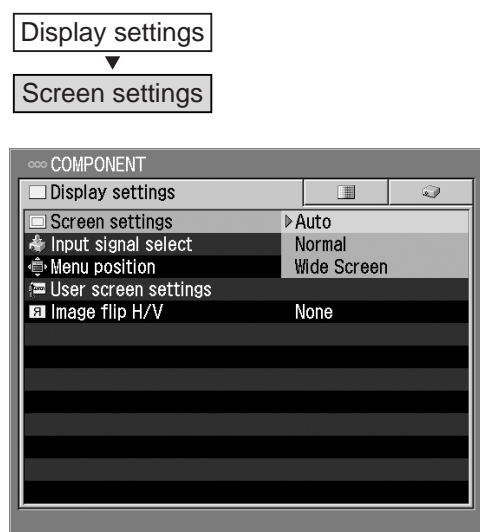

Auto

The screen mode is automatically switched between [Normal] and [Wide Screen] depending on the image from the AV equipment. This item is displayed when Component Input is selected to allow you to select it.

Normal

An image is projected at a 16:9 (W:H) aspect ratio (wide screen size).

Wide Screen

An image is projected at a 4:3 (W:H) aspect ratio (normal screen size).



The upper, lower, left, and/or right portions of a projected image may be missing depending on the selected display mode.

## Selecting a Menu Position

D-RGB A-RGB Video/S-video Component



You can select the position of the menu displayed on the screen.

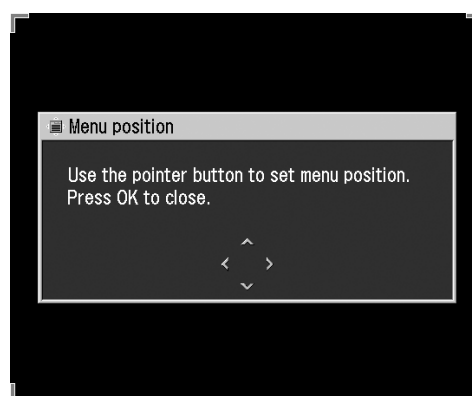
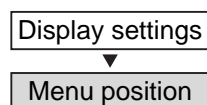

Using [^], [v], [<], and [>] buttons, move the menu position.



When the menu position is determined, press the [OK] button (the menu will disappear 30 seconds later if no button is pressed).

## Capturing a Logo to Be Displayed



D-RGB | A-RGB | Video/S-video | Component

A user's unique image (logo) can be displayed when the power is turned on, there is no input signal, or the image is blacked out temporarily.

Display settings

User screen settings

Logo capture

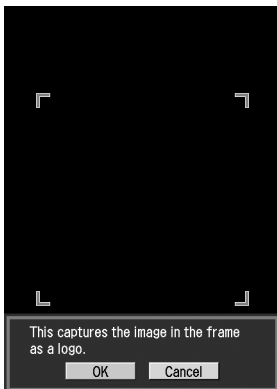

OK

The image to be captured is displayed on the screen. Place the red frame on the capture range and press [OK]. The image in the red frame will be captured.

Cancel

Cancel registration of the image.



- The image on only one screen can be captured.
- To display the captured image, select "Logo capture" on the "Projector on", "No signal", or "NO SHOW" screen.
- No image can be captured depending on the resolution and scan system you selected.

## Selecting a Logo Display Position



D-RGB | A-RGB | Video/S-video | Component

Select a logo display position. A logo can be displayed at the center or in a corner of a desired screen.

Display settings

User screen settings

Logo position

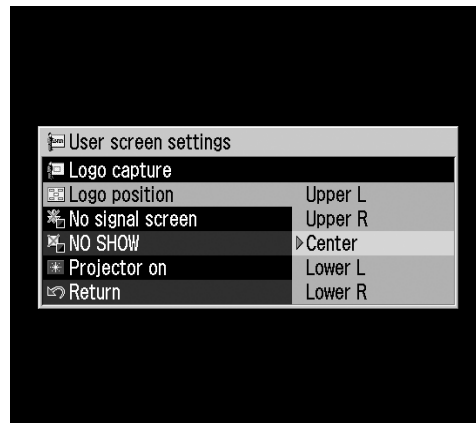

Upper L

Upper R

Center

Lower L

Lower R

Select a logo display position.

## Displaying a Logo (No signal screen)



A logo can be displayed on the screen when there is no input signal.

## Displaying a Logo (NO SHOW)

D-RGB | A-RGB |  | Compo

A logo can be displayed on the screen when the image is blacked out temporarily by pressing the [NO SHOW] button.

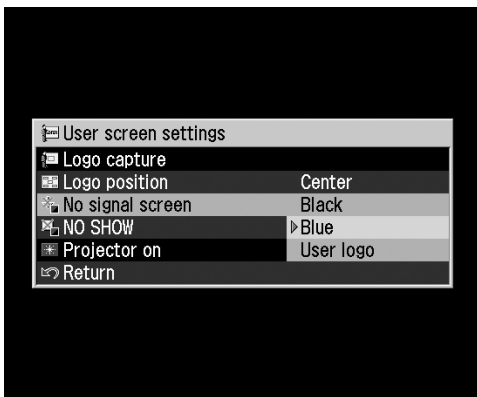

No logo is displayed (black screen).

No logo is displayed (blue-back).

The logo captured on the "Logo capture" screen is displayed.

"User logo" cannot be selected when no logo has been captured.

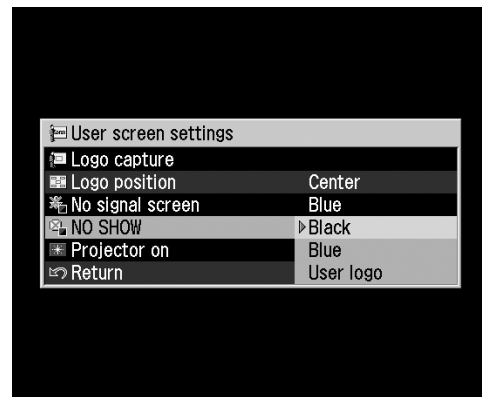

No logo is displayed (black screen).

No logo is displayed (blue-back).

The logo captured on the "Logo capture" screen is displayed.

"User logo" cannot be selected when no logo has been captured.

## Displaying a Logo (Projector on)



D-RGB A-RGB Video/S-video Component

A logo can be displayed from the moment the projector is turned on to the moment it is ready for projection.

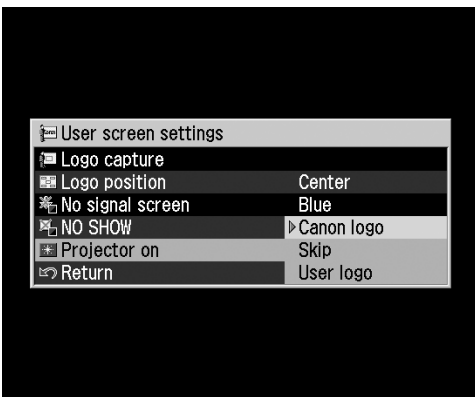
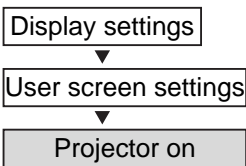

**Canon logo** The factory-captured Canon logo is displayed.

**Skip** An image is projected immediately after the projector is turned on.

**User logo** The logo captured on the "Logo capture" screen is displayed.

**!** "User logo" cannot be selected when no logo has been captured.

## When Ceiling-mounted or for Rear Projection



D-RGB A-RGB Video/S-video Component

Make this setting when the projector is hung from the ceiling or it projects an image on a transmissive screen.

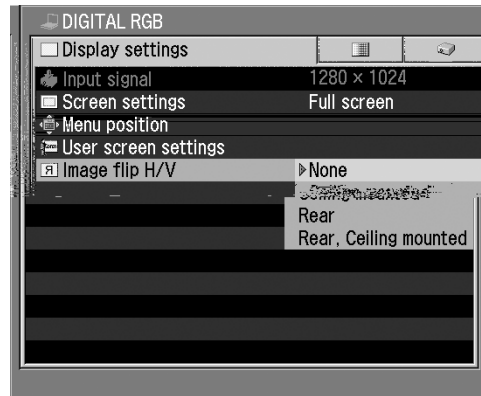
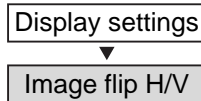

**None** An image is projected normally.

**Ceiling mounted** Select this when projecting an image with the projector hung from the ceiling. An image is projected with it inverted vertically.

**Rear** Select this when projecting an image from behind the screen. An image is projected with it inverted horizontally.

**Rear, Ceiling mounted** Select this when projecting an image from behind the screen with the projector hung from the ceiling. An image is projected with it inverted vertically and horizontally.

**!** When hanging the projector from the ceiling, optional brackets are required. Contact your Canon dealer.

None (Normal image) Ceiling mounted

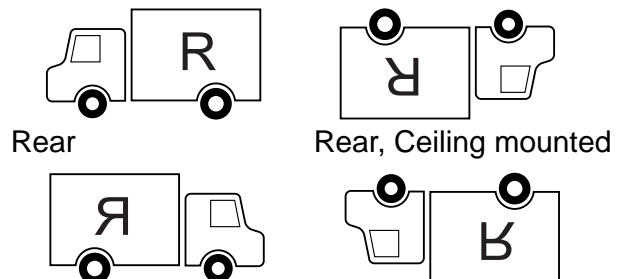

# Image Adj. Menu

The Image adj. menu is used to make various adjustments to the image to be projected.

**Selecting an Image Mode**  
 [Image mode]..... P62

**Adjusting the Brightness [Brightness]... P63**

**Adjusting the Contrast [Contrast]..... P63**

**Adjusting the Sharpness [Sharpness].... P64**

**Making a Gamma Correction [Gamma]... P64**

**Using the Dynamic Gamma Function**  
 [Dynamic Gamma] ..... P65

**Adjusting the Color Level [Color level]... P65**

**Adjusting the Color Balance**  
 [Color balance]..... P66

**Correcting the Screen Color**  
 [Screen color correction] ..... P66

**Making Advanced Color Adjustment**  
 [Advanced color adjustment] ..... P67

**Performing Progressive Processing**  
 [Progressive]..... P67

**Reducing the Lamp Brightness**  
 [Lamp mode] ..... P68

**Resetting the Image Settings [Reset] ..... P68**

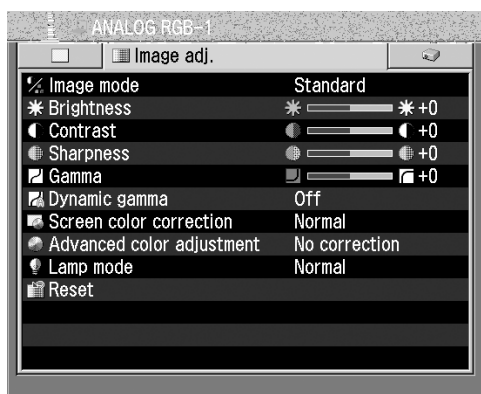

## Selecting an Image Mode



[D-RGB] [A-RGB] [Video/S-video] [Component]

When the color and brightness of the displayed image can be adjusted to match your source.

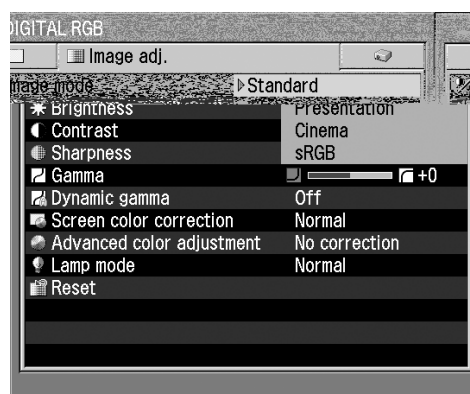
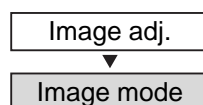

Standard

Select this to project an image with a similar quality to that of the original image. An image is projected with a high regard for reproduction of white.

Presentation

Select this to project an image with a similar quality to that of the original image. A bright and high-contrast image is projected.

Cinema

Select this to project a movie. A picture is projected with a high regard for color tone reproduction.

sRGB

Select this when you want to project an image from a sRGB-compatible digital camera. An image is projected in the display mode conforming to the sRGB Standard.



- The quality (brightness, contrast, etc.) of the image displayed in each image mode can be adjusted as desired.
- The results of adjustments made by the user for each mode are saved for each of six types of input signals.

## Adjusting the Brightness



D-RGB A-RGB Video/S-video Component

When the image is too bright or dark, adjust the brightness.

Image adj.

Brightness

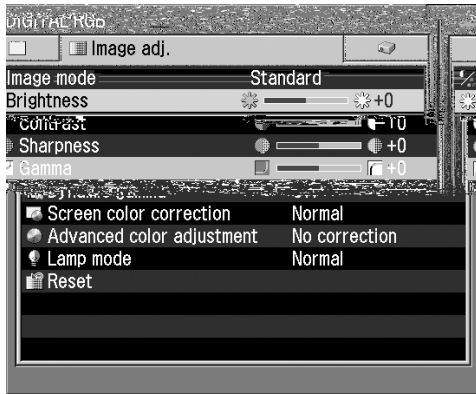

> The image becomes brighter.

< The image becomes darker.

 This setting is saved for the currently selected input signal and image mode.

## Adjusting the Contrast



D-RGB A-RGB Video/S-video Component

When you want to make the image more or less vivid, adjust the difference in tone between the lightest and darkest portions of the image.

Image adj.

Contrast

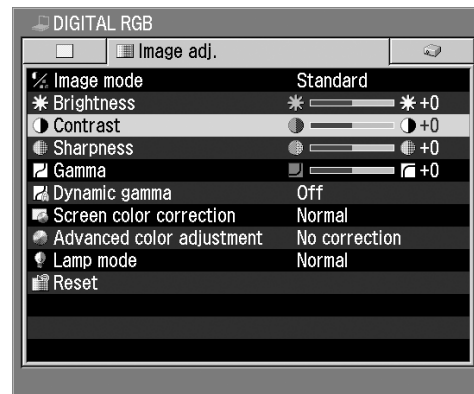

> The contrast increases. The image becomes more vivid.

< The contrast decreases. The image becomes less vivid.

 This setting is saved for the currently selected input signal and image mode.

## Adjusting the Sharpness

D-RGB A-RGB [ ] Component

When you want to make the image sharper or softer, adjust the sharpness of the image.

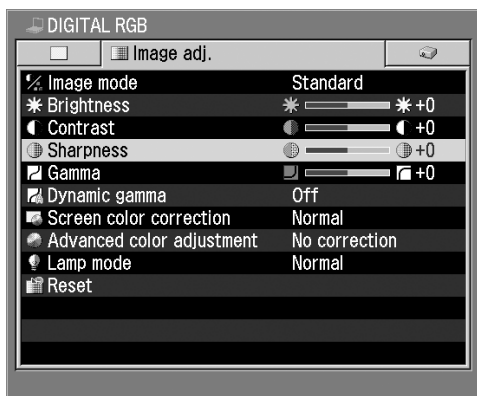

The image becomes sharp.

The image becomes soft.

- Sharpness can be adjusted in four steps in the plus or minus direction.
- This setting is saved for the currently selected input signal and image mode.



Dark and obscure parts become visible.

Light and obscure parts become visible.

This setting is saved for the currently selected input signal and image mode.



## Using the Dynamic Gamma Function



D-RGB A-RGB Video/S-video Component

The tone representation of light and dark areas is adjusted automatically.

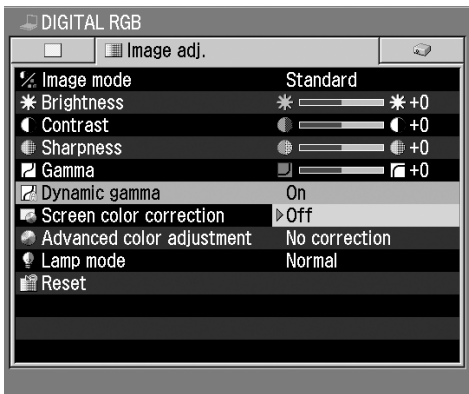
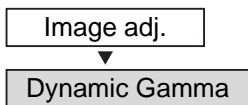

- On The dynamic gamma function is used.
- Off The dynamic gamma function is not used.



- An image is adjusted automatically so that the optimum image quality is attained in real time.
- This setting is saved for the currently selected input signal and image mode.

## Adjusting the Color Level



D-RGB A-RGB Video/S-video Component

When an image is too deep or pale in color, adjust the color level.

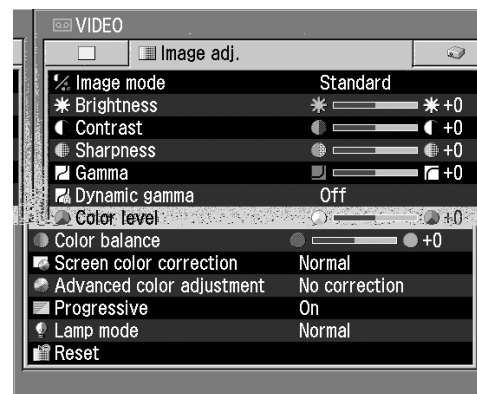

- > The image becomes deeper in color.
- < The image becomes paler in color.



- This setting is saved for the currently selected input signal and image mode.

## Adjusting the Color Balance



D-RGB A-RGB Video/S-video Component

When an image appears too red or green, adjust the color balance.

Image adj.

Color balance

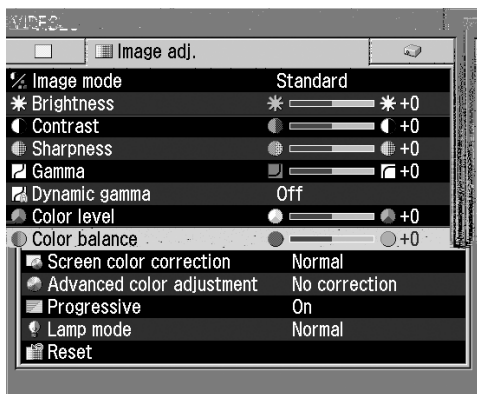

> The reddish image is corrected.

< The greenish image is corrected.



- You cannot adjust the color balance when the video format is PAL, PAL-M, PAL-N, or SECAM.
- This setting is saved for the currently selected input signal and image mode.

## Correcting the Screen Color



D-RGB A-RGB Video/S-video Component

Adjust the while balance so that white areas of the image are displayed correctly.

Image adj.

Screen color correction

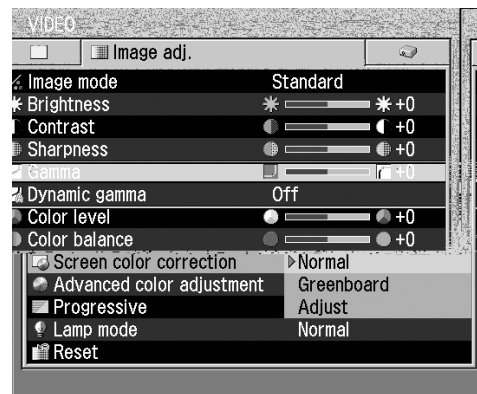

Normal

When a standard screen is used, an image is projected in a color tone similar to that of natural light.

Greenboard

When a greenboard (dark green) is used as a screen, an image is projected in an almost natural color tone.

Adjust

Adjust color tones of red, green, and blue with the level meter.

> The color tone of each color becomes lighter.

< The color tone of each color becomes darker.



This setting is saved for the currently selected input signal and image mode.

## Making Advanced Color Adjustment



D-RGB A-RGB Video/S-video Component

Adjust colors using the memorized color correction function and 6-axis color adjustment function.

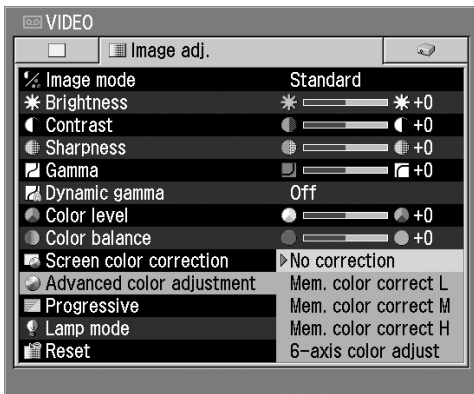
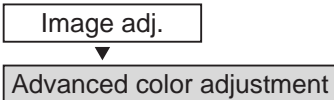

- No correction
- Mem. color correct L
- Mem. color correct M
- Mem. color correct H
- 6-axis color adjust

Color adjustment is not performed.

Colors (e.g., blue sky) in our memory can be adjusted in three steps so that they can be shown more vividly.

A 6-axis color adjustment box (RGB (red/green/black) and CMY (cyan/magenta/yellow)) is displayed to allow you to make fine adjustment of colors.

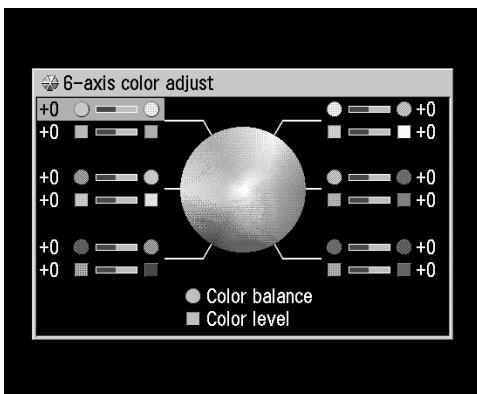

Select the "Color balance" or "Color level" bar using the [^] and [v] buttons, and then adjust colors using the [<] and [>] buttons.

This setting is saved for the currently selected input signal and image mode.

## Performing Progressive Processing



D-RGB A-RGB Video/S-video Component

When you want to project a high-quality image, use the progressive processing function.

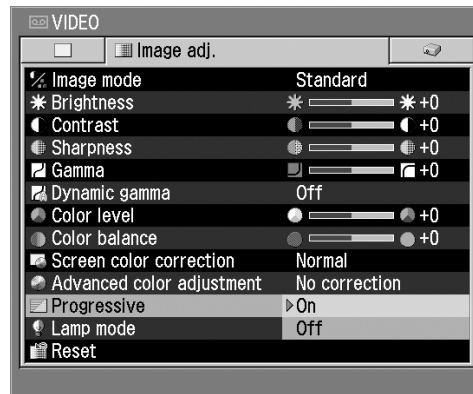

- On
- Off

Progressive processing is performed.

Progressive processing is not performed.



- This function cannot be used when the component signal is 1080i, 1035i, 720p, 575p, or 480p.
- This setting is saved for the currently selected input signal and image mode.
- Select [Off] when flickers and horizontal lines are noticeable on a fast-moving picture.

## Reducing the Lamp Brightness



D-RGB | A-RGB | Video/S-video | Component

When you want to make the image darker or you feel the fan noisy, reduce the lamp brightness.

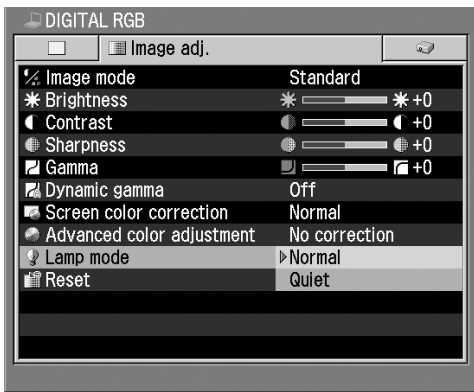
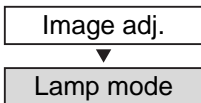

- An image is projected at the normal brightness level.
- The lamp brightness is reduced to make the fan quieter.

-  • Selecting [Quiet] allows you to reduce the power consumption of the lamp.

## Resetting the Image Settings



D-RGB | A-RGB | Video/S-video | Component

If you want to make all image settings from the beginning, you can reset the current settings to the factory defaults.

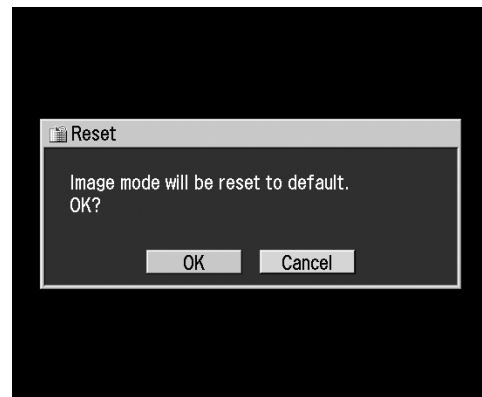

- All image settings are reset.
- Resetting is canceled.

-  Image settings are saved for each input signal and image mode. When [OK] is selected, the settings saved for the image mode of the currently selected input signal are reset.

# System Settings Menu

This menu is used to set various functions of this projector.

- Outputting an Image to a Monitor**  
[Terminal] ..... P69
- Selecting the Power Management Mode**  
[Power management mode] ..... P70
- Issuing a Beep**  
[Beep] ..... P70
- Prohibiting Projector Operation**  
[Key lock] ..... P71
- Registering a Password**  
[Register password] ..... P71
- Setting a Password**  
[Password settings] ..... P72
- Setting up the Remote Control**  
[Remote control] ..... P72
- Selecting a Display Language**  
[Language] ..... P73
- Resetting to Factory Defaults**  
[Factory defaults] ..... P73
- Resetting the Lamp Counter**  
[Lamp counter] ..... P74



## Outputting an Image to a Monitor

A-RGB

You can use the RGB IN-2/COMPONENT IN/RGB OUT terminal as an analog RGB terminal.

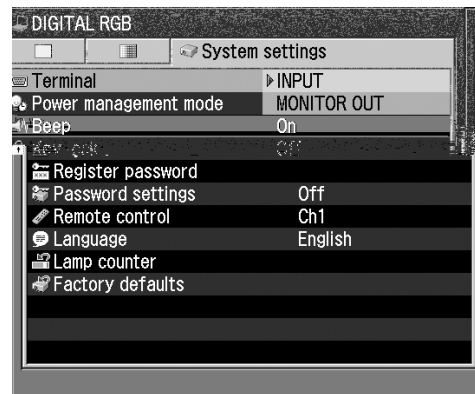
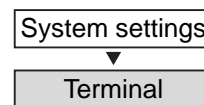

INPUT

The RGB IN-2/COMPONENT IN/RGB OUT terminal is used as an input terminal.

MONITOR OUT

The RGB IN-2/COMPONENT IN/RGB OUT terminal is used as an output terminal.



When [COMPUTER-2] is selected, a monitor output setting cannot be done even if [ANALOG RGB] is selected for the input signal. Press the [COMPUTER-1] button before making a monitor output setting.



An image can be output to a monitor through the RGB IN-2/COMPONENT IN/RGB OUT terminal only when [Computer-1] and [ANALOG RGB] are selected for the input signal.

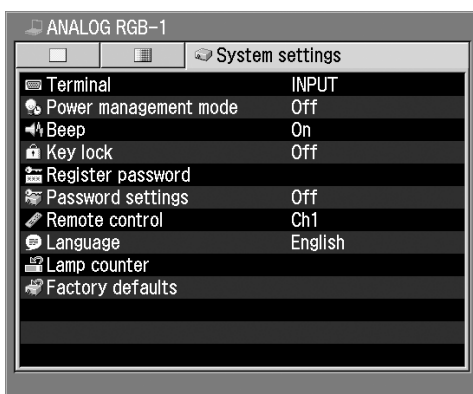

## Selecting the Power Management Mode



D-RGB A-RGB Video/S-video Component

When the projector is not used, the mercury lamp is turned off or the power is turned off automatically for power saving.

System settings

Power management mode

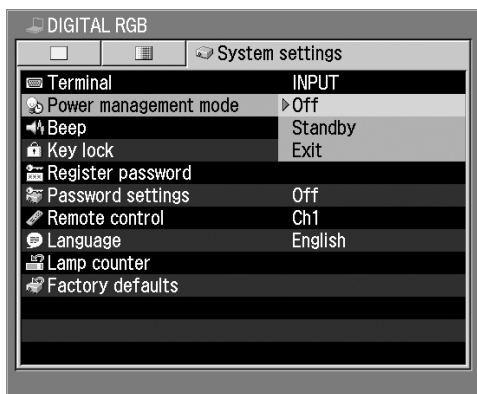

Off

The power management mode is not used.

Standby

The projector enters the power management mode. It restarts projection when a signal is input or an operation button is pressed.

Exit

The projector enters the exit mode, being turned off automatically.



For details on Power Management Mode, refer to P36.

## Issuing a Beep



D-RGB A-RGB Video/S-video Component

A beep can be sounded when the power is turned on/off or a button on the top control or remote control is pressed.

System settings

Beep

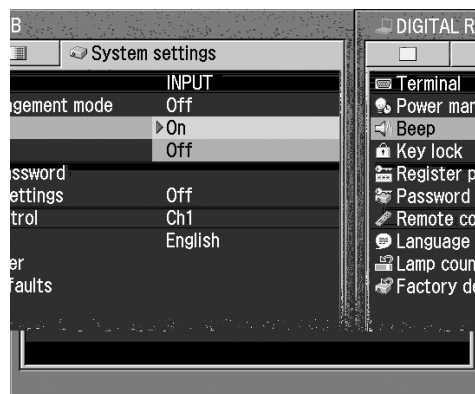

On

A beep is issued.

Off

A beep is not issued.



A beep is not issued when the sound has been muted by pressing the [MUTE] button.

## Prohibiting Projector Operation



D-RGB | A-RGB | Video/S-video | Component

You can prohibit use of the buttons on the top control and remote control to prevent buttons from being pressed by mistake.

System settings

Key lock

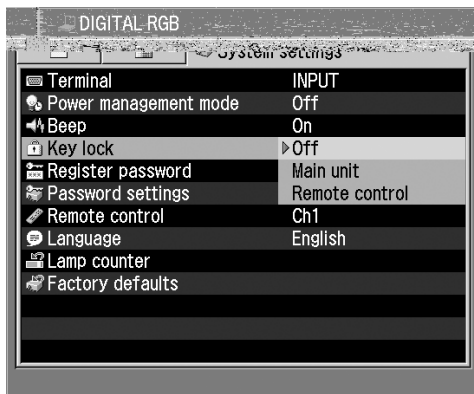

Off

The key lock function is not used.

Main unit

Use of the top control is prohibited.

Remote control

Use of the remote control is prohibited.



- The key lock function becomes effective from the moment the [OK] button is pressed after selecting [Main unit] or [Remote control]. Be sure to press the [OK] button on the top control or remote control which is not locked.
- To unlock buttons forcibly, remove the power plug from the AC outlet after completion of projection, and then insert the power plug with the [OK] button pressed.

## Registering a Password



D-RGB | A-RGB | Video/S-video | Component

Register a password that you need to enter when turning on the projector.

System settings

Register password

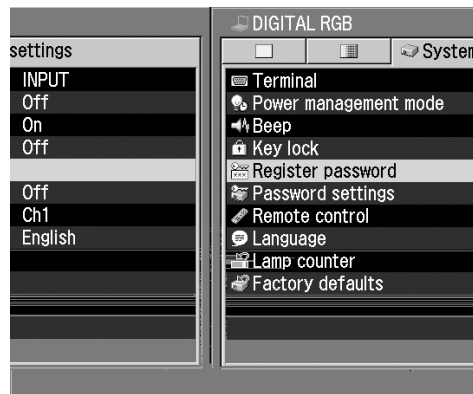

OK

Press the [OK] button and the password entry screen will appear.

Enter a 4-digit password using [^], [>], [v], and [<] buttons.

Pressing the [^] button enters 1, pressing the [>] button enters 2, pressing the [v] button enters 3, and pressing the [<] button enters 4.

Enter digits starting with the leftmost digit. When you finish entering four digits, the password will be registered automatically.



When you want to cancel registering the password, press the [MENU] button without entering the password.



## Setting a Password



D-RGB | A-RGB | Video/S-video | Component

Set a password in the projector. Once the password is set, you will need to enter the password each time you turn on the projector.

System settings

▼  
Password settings

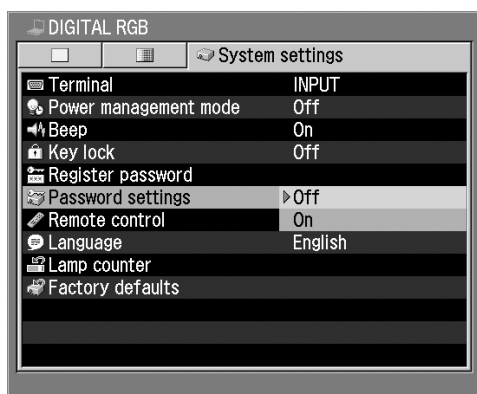

Off

The password function is not used.

On

The password function is used.



- Once a password is set in the projector, a password entry screen appears at power-on. Enter a 4-digit password using [^], [v], [<], and [>] buttons. If the password is valid, projection starts. If you enter a wrong password three times, the projector will be turned off.
- To cancel the password, remove the power plug from the AC outlet after completion of projection, and then insert the power plug in the AC outlet with the [MENU] button pressed.

## Setting up the Remote Control



D-RGB | A-RGB | Video/S-video | Component

When you use two projectors at the same time, change the channel settings to prevent the two remote controls from interfering with each other.

System settings

▼  
Remote control

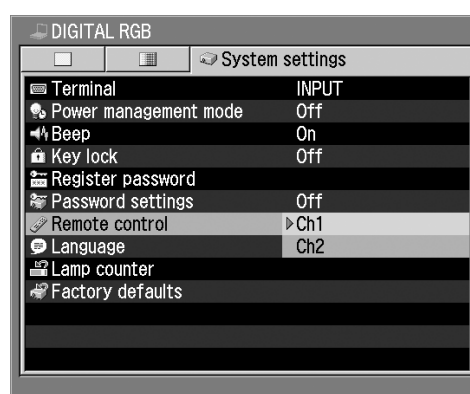

Ch1

Select the channel on the projector you use, and then press the [OK] button.

Ch2

### Selecting a Channel for the Remote Control

While pressing the [OK] button on the remote control, press the [LIGHT] button for 3 seconds.

Pressing the two buttons allows you to switch between CH1 (the button flashes once) and CH2 (the button flashes twice).



- When setting a channel, be sure to set the same channel for either control (remote control or top control). Set a different channel for the other pair.
- When performing menu operation using the remote control, changing the channel by pressing the [OK] button will prevent you from using the remote control.



## Selecting a Display Language

D-RGB | A-RGB | Video/S-video | Component

You can select a language to be used in the menu from 13 different languages.

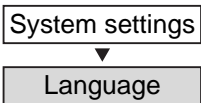

Select a display language.

|            |                       |
|------------|-----------------------|
| English    | English               |
| Deutsch    | German                |
| Français   | French                |
| Italiano   | Italian               |
| Español    | Spanish               |
| Português  | Portuguese            |
| Svenska    | Swedish               |
| Русский    | Russian               |
| Nederlands | Dutch                 |
| 中文简体       | Chinese (Simplified)  |
| 中文繁體       | Chinese (Traditional) |
| 한국어        | Korean                |
| 日本語        | Japanese              |

Select a language and press the [OK] button and all words used in the menu will be displayed in the selected language.

## Resetting to the Factory Defaults

D-RGB | A-RGB | Video/S-video | Component

You can reset menu item settings. The system settings will be restored to the factory defaults.

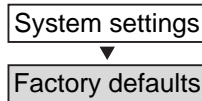

- All menu item settings of the projector are reset to factory defaults.
- Resetting is canceled.

- The [Lamp counter] and [Language] settings will not be reset even after resetting to factory defaults.
- For the factory defaults, refer to P86.

## Resetting the Lamp Counter



D-RGB | A-RGB | Video/S-video | Component

When you have changed the lamp, reset the lamp counter that indicates the lamp replacement timing.

System settings

Lamp counter

- When the time of use is less than 1,000 hours

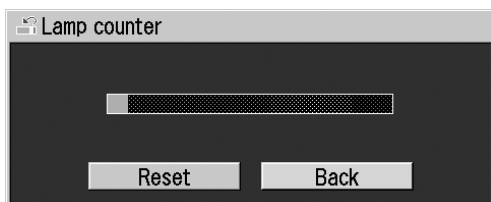

- When the time of use is 1,000 to 1,400 hours



- When the time of use is 1,400 hours or longer



Reset



OK

Cancel

The lamp counter is reset. Resetting of the lamp counter is canceled.



Do not reset the lamp counter except when you have replaced the lamp. If reset, the lamp counter cannot indicate the correct timing of lamp replacement.



For the lamp replacement method, refer to P77.

# MAINTENANCE

## Cleaning the Projector

Clean the projector frequently to prevent dust from accumulating on the surface. A dirty lens can affect the quality of the projected image.



Caution

- The main unit is very hot immediately after turning off the projector. Wait until the projector cools down sufficiently before cleaning the projector. You may get burned or injured.
- Before cleaning, be sure to remove the power plug from the AC outlet. Otherwise, electric shock or fire may result.

### Cleaning the Projector Body

Softly wipe the projector body with a soft cloth.

If the projector is heavily soiled, use a small amount of detergent diluted with water, damp a cloth with this solution, squeeze the cloth hard, wipe the projector body with this cloth, and finish with a dry cloth.



Caution

- Using volatile cleaning liquid or benzene may damage the projector body surface. When using a chemical dust cloth, read the instructions thoroughly.
- To clean the lens, use a commonly available air blower or lens cleaning paper. The lens surface is easily damaged, so do not use a hard cloth or tissues.

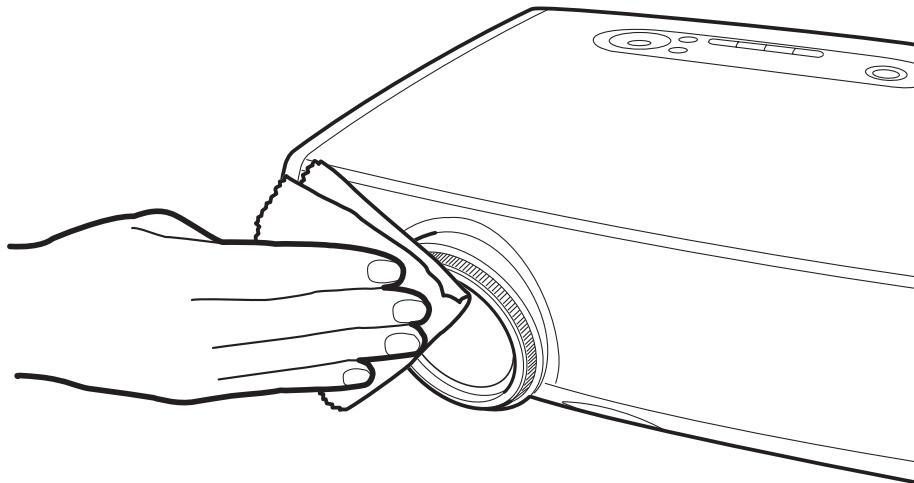

#### When Not Used for an Extended Period of Time

Be sure to attach the lens cap on the lens and store in the supplied carrying bag.

# Cleaning and Replacing the Air Filter

An air filter is installed in the air intake vent on the bottom of the main body to protect the internal lens and mirror from dust. Should the air filter become clogged with dust, it will block the air flow into the projector and causing an internal heat buildup which may cause a problem.



Caution

- The main unit is very hot immediately after turning off the projector. Wait until the projector cools down sufficiently before cleaning the air filter. You may get burned or injured.
- Before cleaning or replacing the air filter, be sure to remove the power plug from the AC outlet. Electric shock or fire may result.
- Do not insert any object into the projector through the air filter opening. You may suffer electric shock or injury due to the high-voltage parts or rotating parts.

## Cleaning the Air Filter

Turn the projector upside down, remove the cover by pushing the latch, remove the air filter, and clean it with a vacuum cleaner.

When cleaning dust off the side exhaust vent and the bottom air intake vent, bring the vacuum cleaner nozzle close to them directly.



- Clean the air filter frequently.
- After cleaning the air filter, install it following the removal steps in reverse.

## Procedure for Replacing the Air Filter

- 1** Turn off the projector, remove the power plug from the AC outlet, and leave the projector stand for at least 1 hour.
- 2** Remove the filter cover by pushing the latch.
- 3** Remove the air filter.
- 4** Attach a new air filter under the filter cover.
- 5** Install the filter cover in place.

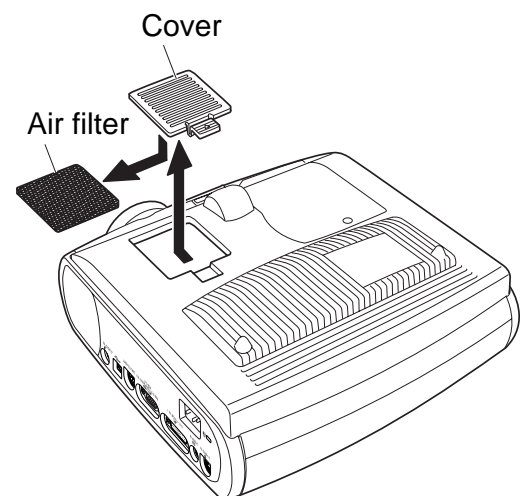

- Attach the lens cap when replacing the air filter.
- Handle the air filter carefully. If damaged, the air filter will not work properly.
- Replace the air filter whenever you replace the lamp.
- An air filter can be ordered from your Canon dealer.

# Replacing the Lamp

When the time of use of the lamp is 1400 hours or longer, the following message (two types) is displayed for 10 seconds each time the projector is turned on.

- When the time of use is 1,400 to 1,500 hours



- When the time of use is 1,500 hours or longer

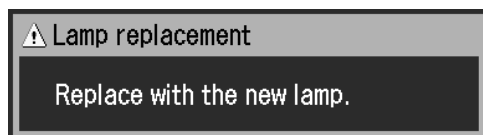

- This message will not appear again, if you select [No] in response to the message "Do you want to display this message again?".
- Check the time of use of the lamp in [Lamp counter] from the System settings menu. (P74)



- When replacing the lamp, turn off the projector, wait until the cooling fan stops, remove the power plug from the AC outlet, and let the projector stand for at least 1 hour. You may get burned because the main unit is very hot immediately after the projector is turned off.
- When replacing the lamp do not touch the inner glass surface. The projector's performance may degrade.

## About the Replacement Lamp

This projector uses the following lamp.

Lamp type No. : RS-LP01



Be sure to use the lamp of the specified type.



A lamp can be ordered from your dealer.

## Procedure for Replacing the Lamp

**1** Turn off the projector and disconnect the power plug from the AC outlet. Allow the projector to cool for a least 1 hour.

**2** Detach the lamp cover by loosening a screw with a flathead screwdriver.

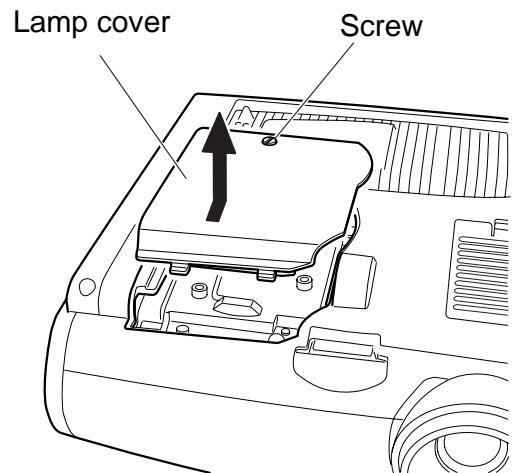

**3** Loosen two screws, turn up the handle, and remove the lamp.

**4** Insert a new lamp as far as it will go and secure it with two screws.  
\* After installation, be sure to turn down the handle.

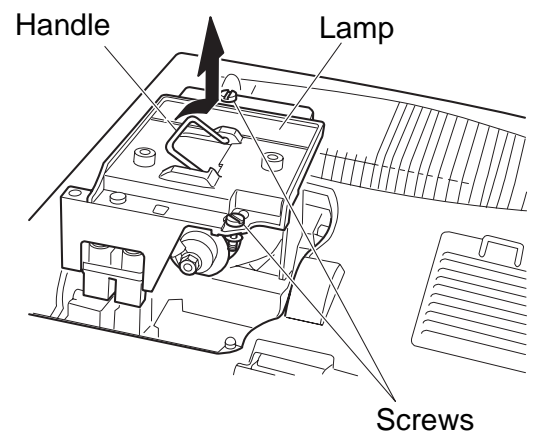

**5** Install the lamp cover and tighten the screw.

**6** Turn on the projector.

**7** Bring up the menu and select [System settings] -> [Lamp counter]. (P74)

**8** Select [Reset] -> [OK] to reset the lamp counter.

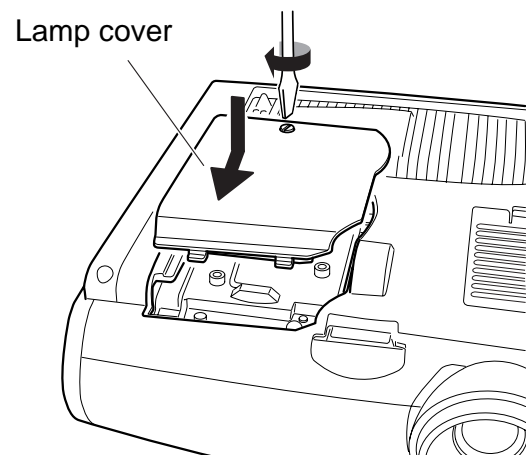

# TROUBLESHOOTING

## Understanding the Warning Lamp Flash Patterns

When an internal problem occurs, the WARNING lamp on the Control Panel flashes red.

 When dealing with the problem, turn off the projector, wait until the cooling fan stops, remove the power plug from the AC outlet.

| Flash Pattern | Meaning              | Countermeasure   |
|---------------|----------------------|--|
| One flash     | Abnormal temperature | The temperature inside the projector is too high for some reason or the outside air temperature is higher than the specified one.<br>If the problem is inside the projector, check whether the projector is installed and operated normally, turn off the projector to cool its inside, and retry projection. If the same warning occurs again, the projector may be defective. Contact your dealer. |
| Two flashes   | Faulty lamp          | The lamp has burnt out. Replace the lamp with a new one. If the same warning occurs again, the lamp drive circuit may be defective. Contact your dealer.   |
| Three flashes | Faulty lamp cover    | The lamp cover is open. Check whether the lamp cover is installed properly. If it is installed properly, the lamp cover detection switch may be defective. Contact your dealer.  |
| Four flashes  | Faulty cooling fan   | The cooling fan or another component may be defective. Contact your dealer.  |
| Five flashes  | Faulty power supply  | The voltage of part of the power supply is abnormally high or any other problem has occurred in the power supply. Contact your dealer.   |

# Symptoms and Solutions

## No power

| Cause  | Countermeasure   |
|--|--|
| The power cord is not connected properly.                                | Check whether the power cord is connected properly. (P26)  |
| The power cord has just been connected.                                  | After connecting the power plug, you cannot turn on the projector before the [POWER] lights red. (P27)   |
| You attempted to turn on the projector immediately after turning it off. | The projector cannot be turned on for about 90 seconds after it is turned off.<br>Wait for at least 90 seconds and press the [POWER] button again. (P35) |

## No image

| Cause  | Countermeasure  |
|--|---|
| Any connection cable is connected improperly.                                | Check whether the projector is properly connected to the computer and AV equipment. (P23, 42)   |
| 20 seconds have not passed since the projector was turned on.                | When the projector is turned on, the Opening window is displayed for about 20 seconds. To project an image immediately, press the [OK] button on the remote control or top control. (P27) |
| No image is sent from the AV equipment.                                      | Check that an image is played back on the connected digital camera, video camcorder, DVD, etc. (P47)  |
| Connection to the video terminal or selection of a signal type is incorrect. | Check that connection to the video terminal is correct. Also check that selection of a signal type is correct. (P28, 47)  |
| The [NO SHOW] function is selected.  | Press the [NO SHOW] button on the remote control. (P37)   |
| No image is sent due to the problem occurred on the computer side.           | Turn on the projector and computer in this order again.   |



## No sound

| Cause  | Countermeasure  |
|--|---|
| The audio cable is not connected properly.       | Check whether the audio cable is connected properly. (P24, 43)                                  |
| The [MUTE] function is selected.                 | Press the [MUTE] button on the remote control. (P40)  |
| The volume level is adjusted to the minimum.     | Adjust the [VOL+] button on the remote control or top control to adjust the volume level. (P40) |
| An audio cable with a built-in resistor is used. | Use an audio cable without a built-in resistor.   |

## Out of focus

| Cause   | Countermeasure   |
|---|--|
| The image is out of focus.  | Adjust the focus. (P30)  |
| The lens cap is not removed.  | Remove the lens cap. (P92)   |
| The distance to the screen is too short.  | Check whether the distance to the screen is proper. If the distance is shorter than about 3.9' (1.2 m), the image cannot be brought to a focus. (P20, 85)  |
| The projector is not placed straight in front of the screen.                          | Check whether an image is obliquely projected to the screen. A slight error in the projection angle can be corrected through keystone adjustment. (P21, 31)  |
| The projector has been moved to a place where the difference in temperature is large. | When the projector is moved from a low-temperature place to a high-temperature place, dew may form on the lens. Dew will evaporate a while later and the projector will be able to project a normal image. |

## Top/bottom or left/right reversed

| Cause   | Countermeasure   |
|---|--|
| An image is projected with its top and bottom or left and right reversed. | The ceiling mounted/rear projection setting is incorrect. Check the "Image flip H/V" setting in the Display settings menu. (P61) |

## Cannot project image from notebook computer

| Cause   | Countermeasure   |
|---|--|
| The connection cable is not connected properly.                                 | Check whether the connection cable is properly connected to the video terminal of the computer. (P23)  |
| The video signal type is incorrect.   | Check whether the selected signal type is correct. (P28, 84)   |
| The external monitor output setting on the notebook computer is incorrect.      | Turn on the external monitor output on the notebook computer.<br>To turn on the external monitor output, press the [LCD] or [VGA] function key while pressing the [Fn] key on the keyboard of the notebook computer. (P24)<br>The combination of keys used to perform this operation varies among computer manufacturers. Refer to the User's Manual that came with your computer. |
| The displayed image is not the same as that displayed on the notebook computer. | Check whether the dual screen (multi-display) mode is selected on the notebook computer.<br>When the dual screen mode is selected, change it to the simultaneous display mode (output setting) on the notebook personal computer.<br>The output setting method varies among computer manufacturers. Refer to the User's Manual that came with your computer.                       |

## Power turns off

| Cause  | Countermeasure   |
|--|--|
| The air intake or exhaust vent is blocked.   | Check whether the air intake or exhaust vent is blocked.<br>If the air intake or exhaust vent is blocked, the temperature inside the projector rises and the power is automatically turned off to protect the main body of the projector. Wait until the internal temperature lowers, and turn on the projector with the intake and exhaust vents unblocked. (P21, 76) |
| The air filter is dirty.                     | Check whether the bottom air filter is clogged with dust.<br>If the air filter is clogged, clean or replace the air filter. (P76)  |
| The lamp has burnt out (or it is defective). | Check whether the lamp has burnt out.<br>If the lamp has burnt out, replace it.<br>The lamp may be defective if it has not burnt out. Check the lamp by replacing it with a spare lamp if you have it. (P12, 77)   |
| The operating temperature is improper.       | Check whether the operating temperature is 5 to 35°C. (P13)  |
| Others                                       | The projector may be out of order. Contact Canon dealer immediately. (Back cover)  |

## Cannot operate the remote control

| Cause  | Countermeasure  |
|--|---|
| Batteries are not installed properly or they have run out.                       | Check whether batteries are installed properly. If batteries are installed properly, replace them with one batteries. (P17)   |
| You are operating the remote control outside the remote control operating range. | Check whether you are operating the remote control within the remote control operating range.<br>Also check whether there is any obstacle between the infrared remote receiver of the projector and the remote control. (P16) |
| The operating environment of the remote control is bad.                          | Check whether the infrared remote receiver of the projector is exposed to direct sunlight or strong light of lighting apparatus. (P16)  |
| The remote control code does not match the projector setting.                    | Check whether the remote control code has been changed.<br>You can confirm the "Remote control" setting in the System settings menu. (P72)  |
| "Key lock" is turned on to disable remote control operation.                     | Check whether "Key lock" is turned on to disable remote control operation.<br>In the System settings menu, set "Key lock" to "Off." (P71)   |

## Cannot operate the wireless mouse

| Cause  | Countermeasure  |
|--|---|
| The USB cable is not connected properly.               | Check whether the USB cable is properly connected between the projector and computer. (P41)                             |
| A mouse driver is not installed.                       | Check whether the mouse can be used on the computer side. If it cannot be used, install a mouse driver in the computer. |
| The mouse is not recognized due to a computer problem. | Turn on the projector and computer in this order again.   |



This symbol on the nameplate means the product is Listed by Underwriters Laboratories Inc. It is designed and manufactured to meet rigid U.L. safety standards against risk of fire, casualty and electrical hazards.



The CE Mark is a Directive conformity mark of the European Community (EC).

# APPENDIX

200  
50.0  
59.

computer sig

# Relationship between Screen Size and Projection Distance

| Screen size at 4:3 aspect ratio<br>W x D (cm) | Zoomed projection distance |               | H1             | H2            | Screen size at 16:9 aspect ratio<br>W x D (cm) |
|---|----------------------------|---------------|----------------|---------------|--|
|   | Max.                       | Min.          |                |               |  |
| 40" 81 x 61                                   | 2.0 m (6.6')               | 1.2 m (3.9')  | 55 cm (1.8')   | 6 cm (0.2')   | 37" 81 x 46                                    |
| 50" 102 x 76                                  | 2.5 m (8.2')               | 1.5 m (4.9')  | 69 cm (2.3')   | 8 cm (0.26')  | 46" 102 x 57                                   |
| 60" 122 x 91                                  | 3.0 m (9.8')               | 1.8 m (5.9')  | 82 cm (2.7')   | 9 cm (0.3')   | 55" 122 x 69                                   |
| 70" 142 x 107                                 | 3.5 m (11.5')              | 2.1 m (6.9')  | 96 cm (3.1')   | 11 cm (0.36') | 64" 142 x 80                                   |
| 80" 163 x 122                                 | 4.0 m (13.1')              | 2.4 m (7.9')  | 110 cm (3.6')  | 12 cm (0.4')  | 74" 163 x 91                                   |
| 90" 183 x 137                                 | 4.5 m (14.8')              | 2.7 m (8.9')  | 123 cm (4.0')  | 14 cm (0.46') | 83" 183 x 103                                  |
| 100" 203 x 152                                | 5.0 m (16.4')              | 3.0 m (9.8')  | 137 cm (4.5')  | 15 cm (0.49') | 91" 203 x 114                                  |
| 110" 224 x 168                                | 5.5 m (18.0')              | 3.3 m (10.8') | 151 cm (5.0')  | 17 cm (0.56') | 101" 224 x 126                                 |
| 120" 244 x 183                                | 6.0 m (19.7')              | 3.6 m (11.8') | 165 cm (5.4')  | 18 cm (0.59') | 110" 244 x 137                                 |
| 130" 264 x 198                                | 6.5 m (21.3')              | 3.9 m (12.8') | 178 cm (5.8')  | 20 cm (0.66') | 119" 264 x 149                                 |
| 140" 284 x 213                                | 7.0 m (23.0')              | 4.2 m (13.8') | 192 cm (6.3')  | 21 cm (0.69') | 128" 284 x 160                                 |
| 150" 305 x 229                                | 7.5 m (24.6')              | 4.5 m (14.8') | 206 cm (6.8')  | 23 cm (0.75') | 138" 305 x 171                                 |
| 160" 325 x 244                                | 8.0 m (26.2')              | 4.8 m (15.7') | 219 cm (7.2')  | 24 cm (0.79') | 147" 325 x 183                                 |
| 170" 345 x 259                                | 8.5 m (27.9')              | 5.1 m (16.7') | 233 cm (7.6')  | 26 cm (0.85') | 156" 345 x 194                                 |
| 176" 358 x 268                                | 8.8 m (28.9')              | 5.3 m (17.4') | 241 cm (7.9')  | 27 cm (0.86') | 162" 358 x 201                                 |
| 180" 366 x 274                                | 9.0 m (29.5')              | 5.4 m (17.7') | 247 cm (8.1')  | 27 cm (0.86') | 165" 366 x 206                                 |
| 182" 370 x 277                                | 9.1 m (29.9')              | 5.5 m (18.0') | 250 cm (8.2')  | 28 cm (0.9')  | 167" 370 x 208                                 |
| 190" 386 x 290                                | -                          | 5.7 m (18.7') | 261 cm (8.6')  | 29 cm (0.95') | 174" 386 x 217                                 |
| 200" 406 x 305                                | -                          | 6.0 m (19.7') | 274 cm (9.0')  | 30 cm (0.98') | 184" 406 x 229                                 |
| 210" 427 x 320                                | -                          | 6.3 m (20.7') | 288 cm (9.4')  | 32 cm (1.05') | 193" 427 x 240                                 |
| 220" 447 x 335                                | -                          | 6.6 m (21.7') | 302 cm (9.9')  | 34 cm (1.12') | 202" 447 x 251                                 |
| 230" 467 x 351                                | -                          | 7.0 m (23.0') | 315 cm (10.3') | 35 cm (1.15') | 211" 467 x 263                                 |
| 240" 488 x 366                                | -                          | 7.3 m (24.0') | 329 cm (10.8') | 37 cm (1.21') | 220" 488 x 274                                 |
| 250" 508 x 381                                | -                          | 7.6 m (24.9') | 343 cm (11.3') | 38 cm (1.25') | 233" 508 x 286                                 |
| 260" 528 x 396                                | -                          | 7.9 m (25.9') | 357 cm (11.7') | 40 cm (1.31') | 239" 528 x 297                                 |
| 270" 549 x 411                                | -                          | 8.2 m (26.9') | 370 cm (12.1') | 41 cm (1.35') | 248" 549 x 309                                 |
| 280" 569 x 427                                | -                          | 8.5 m (27.9') | 384 cm (12.6') | 43 cm (1.41') | 257" 569 x 320                                 |
| 290" 589 x 442                                | -                          | 8.8 m (28.9') | 398 cm (13.1') | 44 cm (1.44') | 266" 589 x 331                                 |
| 300" 610 x 457                                | -                          | 9.1 m (29.9') | 411 cm (13.5') | 46 cm (1.51') | 276" 610 x 343                                 |

# Menu Configuration

Factory Defaults

## Switching between Computer and AV Equipment

Select the input terminal of the equipment from which an image is to be input, and select an input signal type using a button on the remote control or top control.

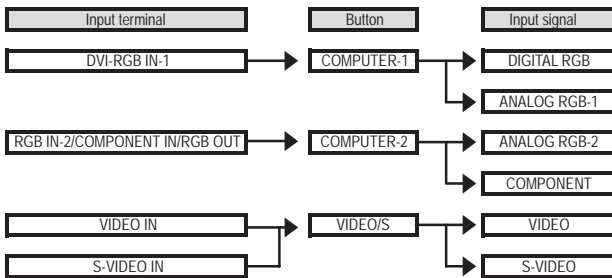

## Items in Menu

Items displayed in the menu vary depending on the selected input signal.

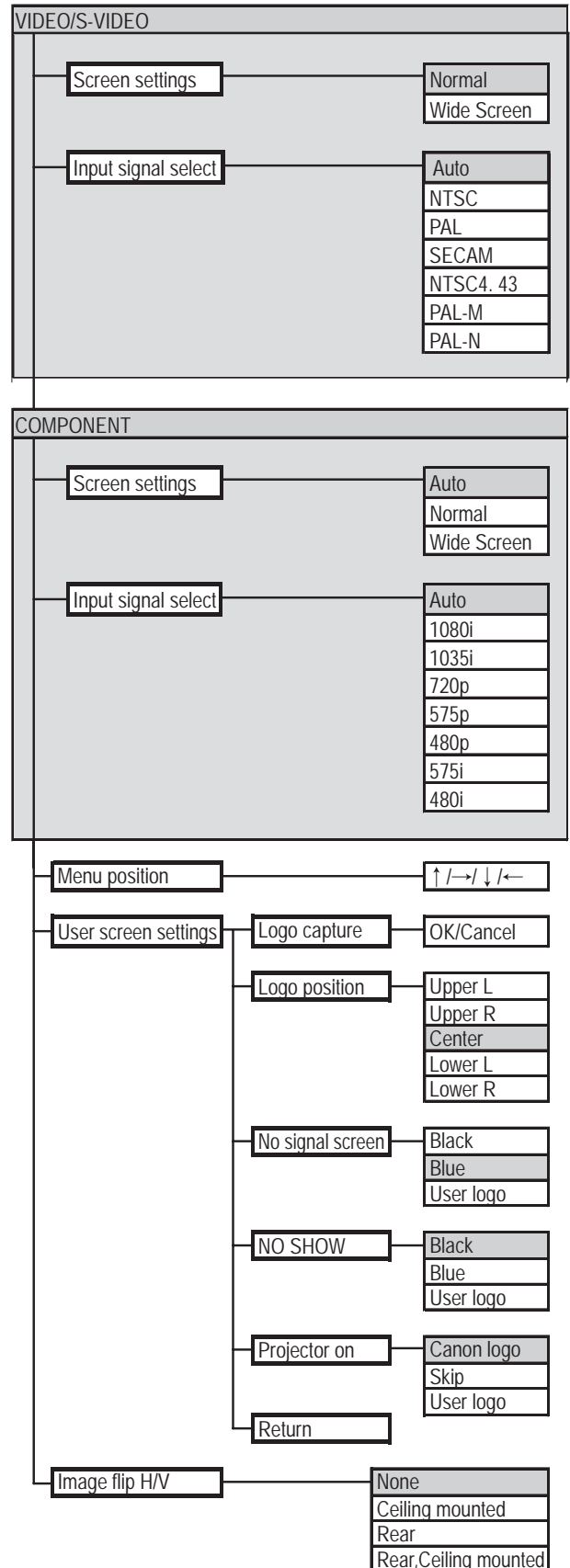
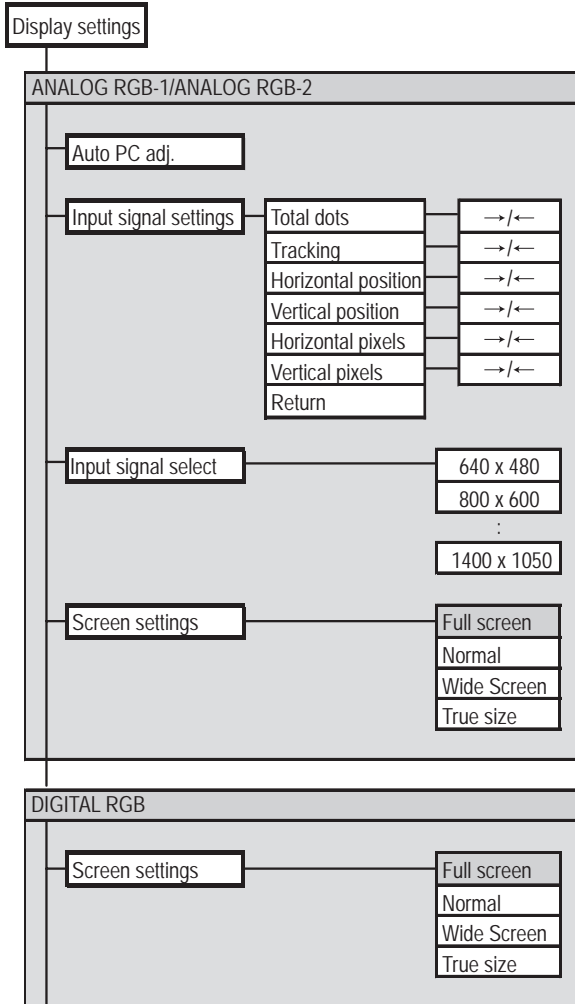

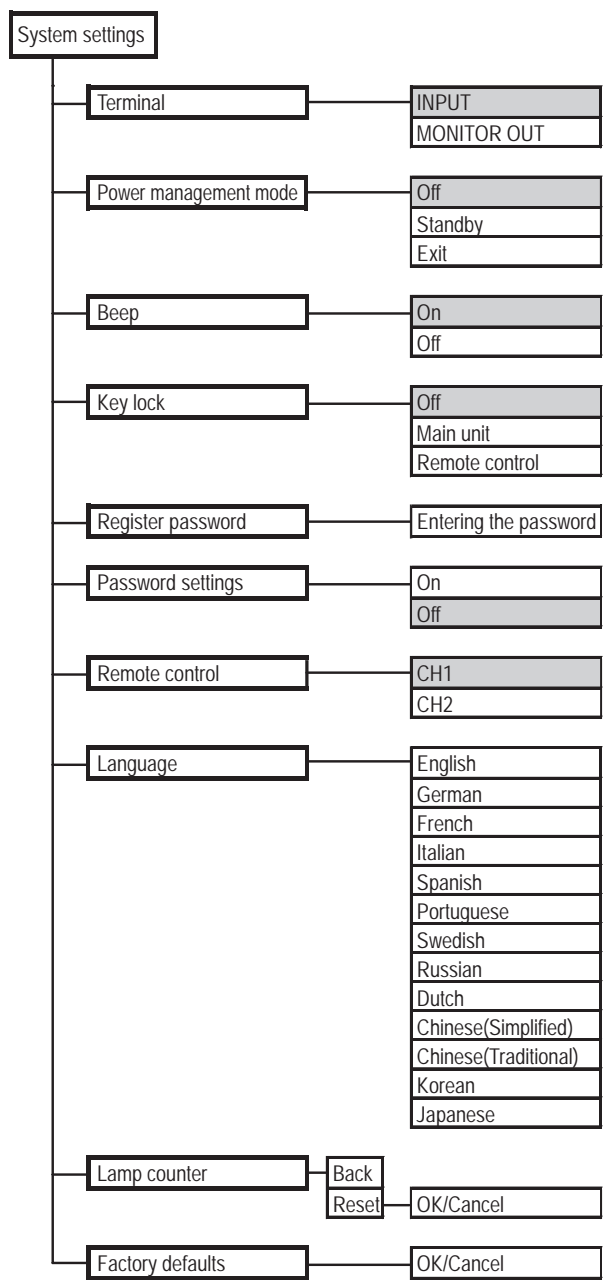
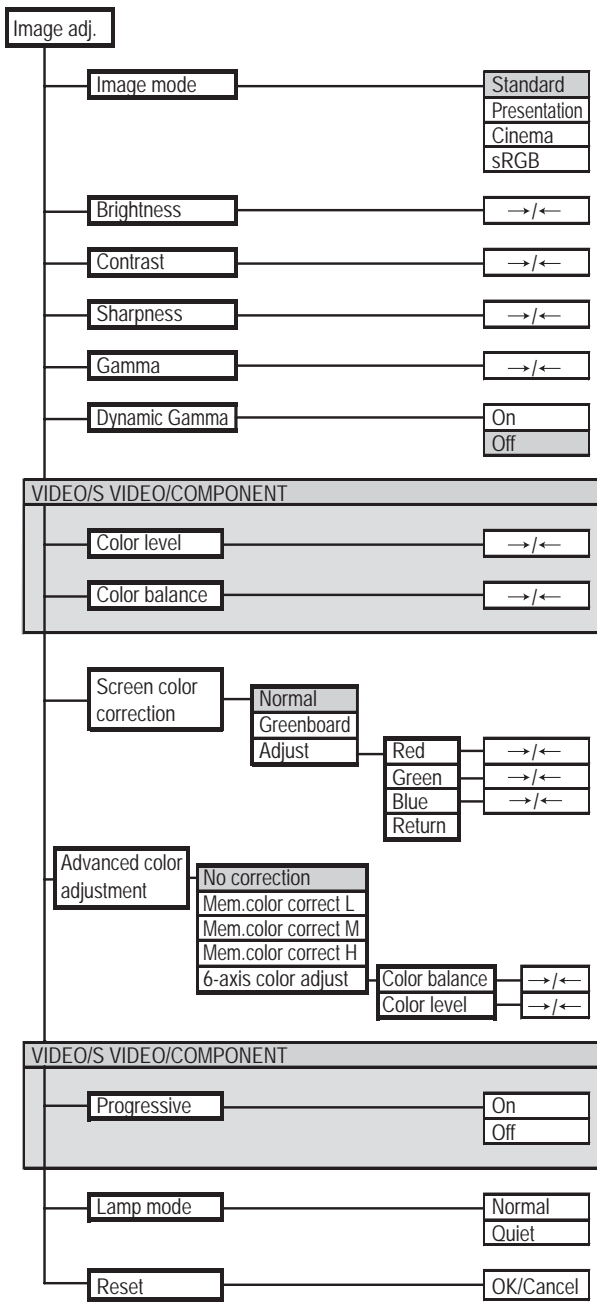

**█** : Factory defaults (settings after resetting)

# Glossary

## Analog RGB

A signal system used to send information about R (red), G (green), and B (blue) with analog values. It is a typical system for connecting a color monitor to a computer. Connect the analog RGB output terminal of the computer and the DVI-I/RGB IN-1 terminal or RGB-2/COMPONENT IN/RGB OUT terminal of this projector with a monitor cable. When the RGB IN-1 terminal is used, select “ANALOG RGB-1” by pressing the [COMPUTER-1] button. When the RGB IN-2 terminal is used, select “ANALOG RGB-2” by pressing the [COMPUTER-2] button.

## Digital RGB

A signal system used to send information about individual display dots with digital values. This system is free from deterioration of image quality because of no analog conversion. Connect the DVI output terminal of the computer and the DVI-I/RGB IN-1 terminal of this projector with a connection cable and select “DIGITAL RGB” by pressing the [COMPUTER-1] button.

## Video

An output terminal widely used for AV equipment. It is also called a composite output terminal (pin terminal or RCA terminal). For more details, refer to “Composite”.

## S-video

A signal system (YC separation signal) used to send a brightness signal (Y) and color signal (C) separately. Connect the S-video terminal of AV equipment and the S-VIDEO IN terminal of this projector with an S-video cable and select “S-VIDEO” by pressing the [VIDEO/S] button.

## Component

A signal system used to send a color signal (C) with it divided into a B-Y color difference signal and an R-Y color difference signal. This system can project a better-quality image as compared with the composite signal system. Connect the video terminal of AV equipment and the RGB-2/COMPONENT IN/RGB OUT terminal with a component cable and select “COMPONENT” by pressing the [COMPUTER-2] button.

## Composite

A video signal system used to send a brightness signal (Y) and a color signal (C) together. Connect the composite output terminal (RCA) of AV equipment and the VIDEO IN terminal of this projector with a video cable and select “VIDEO” by pressing the [VIDEO/S] button.

## sRGB

An international standard of color representation (color space) which is applied to digital cameras, displays and others. If you select sRGB, the projector can project the best-quality image conforming to the sRGB Standard.



## Progressive

An image display system used to display the entire screen per scan. When an interlace signal (video signal) that displays one screen by two scans (one for odd lines and one for even lines) is input, progressive processing is required. When the progressive function is turned off, one screen is displayed using image signals per interlace signal, deteriorating the vertical resolution of the image. When the progressive function is turned on, one screen is displayed using image signals per two interlace signals, improving the vertical resolution of the image. Turn off the progressive function when flickering and horizontal lines are noticeable on a fast-moving picture.

## Resolution

The number of dots (horizontal dots x vertical dots) that can be displayed on a computer is called “resolution of display”. Resolution indicates the size of the display area (amount of information).

| Resolution | Number of dots |          |
|------------|----------------|----------|
|            | Horizontal     | Vertical |
| VGA        | 640            | 480      |
| SVGA       | 800            | 600      |
| XGA        | 1024           | 768      |
| SXGA       | 1280           | 1024     |
| SXGA+      | 1400           | 1050     |
| UXGA       | 1600           | 1200     |

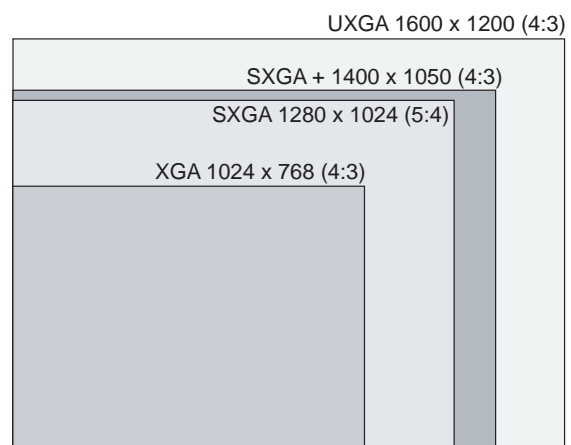

Number of pixels in each resolution

Selecting SXGA+ (1400 dots x 1050 dots) as the display resolution of the computer allows this projector to project high-resolution images. If your computer does not have the SXGA+ option, select the maximum resolution among the selectable options.

## Gamma Correction

A tone adjustment system used during projection of image data. The gamma correction function works effectively when portions of an image are obscure because they are too light or dark.

This projector supports manual gamma correction, automatic gamma correction, and dynamic gamma correction.

## DVI-I

A digital video signal connection interface. This interface allows digital data to be sent and received without conversion to analog data, assuring high image quality with no signal degradation. The DVI-I (integrated) connector can be used to send and receive analog RGB video signals in addition to digital signals.

|  |  |
|--|--|
|  |  |
|  | irror/polarizing beam splitter and color composition by prism  |
|  |  |
|  | annels/4,410,000   |
|  | to 1.46")/F1.85 to F2.5  |
|  | g  |
|  | mp   |
|  |  |
|  |  |
|  | 50-100 Hz  |
|  | 1400 x 1050 dots   |
|  | 80i, 480p  |
|  | , PAL-M, PAL-N   |
|  | an analog RGB)   |
|  | B an component)/One output terminal (analog RGB)   |
|  |  |
|  |  |
|  | Differential Signaling)  |
|  | ance = 75Ω   |
|  | ion: TTL level, negative or positive polarity  |
|  | B signal: 0.3Vp-p, negative polarity, impedance = 75Ω  |
|  | nization, impedance = 75Ω  |
|  | f: 1Vp-p, negative synchronization, impedance = 75Ω  |
|  | impedance = 75Ω  |
|  | b Cr/Pr signal   |
|  | nization, impedance = 75Ω  |
|  | = 75Ω Cr/Pr: 0.7Vp-p, impedance = 75Ω  |
|  | KΩ or more   |
|  | B (silent mode)  |
|  |  |
|  | z (The U.S.A. and Canada) AC 200 to 240 V, 50/60 Hz (Continental Europe)   |
|  | 0 W (silent mode), 6 W (standby)   |
|  | (D) mm / 11.2 (W) x 3.8 (H) x 11.3 (D) in (excluding protrusions)  |
|  |  |
|  | ies for remote control, power cord, computer connection cable, USB cable,<br>arrying bag, lens cover, string for lens cover, User's Manual, Quick Start Guide, |

ing projection, 0.01% or less of pixels may stay lit or unlit due to the characteristics of the LCD  
of time may accelerate the deterioration of optical parts.

**Remote Control**

|                                  |   |
|----------------------------------|---|
| Power supply                     | Two 3.0 V, AAA-size alkaline batteries                        |
| Operating range                  | About 5 m (16.4') (to infrared remote receiver)               |
| Dimensions                       | 42 (W) x 22 (H) x 135 (D) mm / 1.7 (W) x 0.9 (H) x 5.3 (D) in |
| Weight (not including batteries) | 55 g  |

## External View

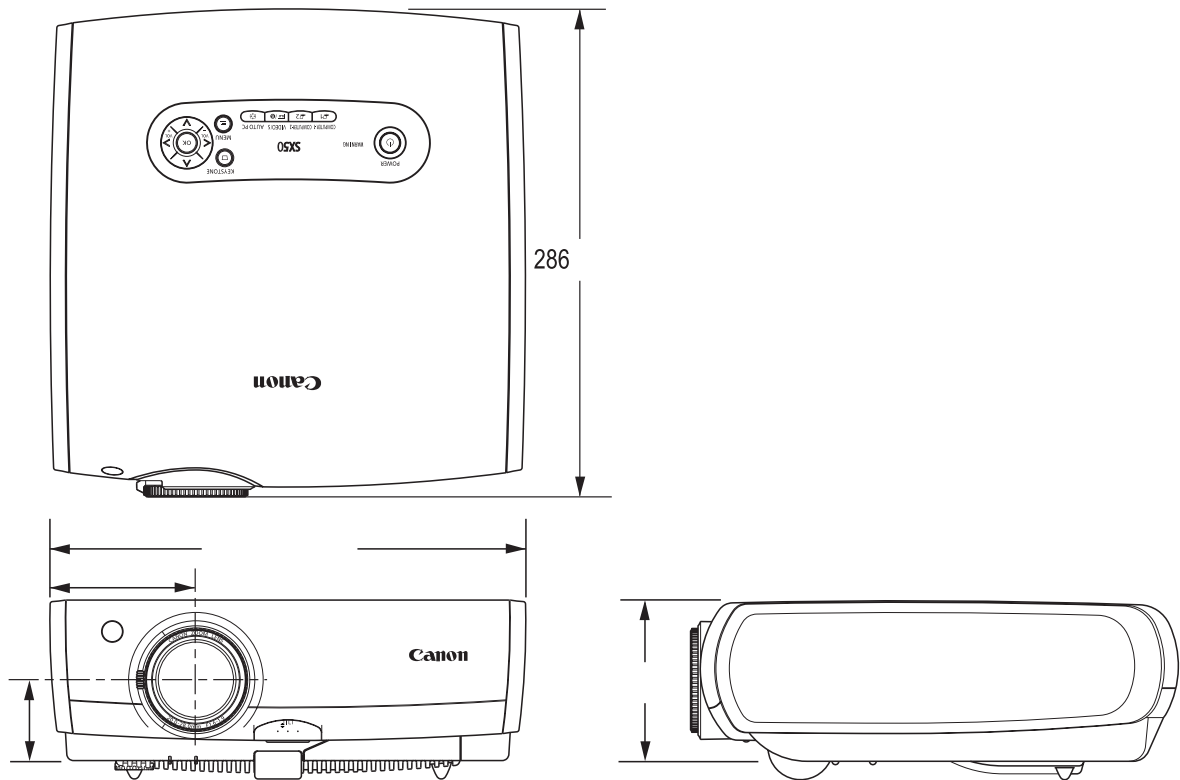

## RGB IN-2/COMPONENT IN/RGB OUT (Computer Input, Component Input, and Monitor Input/Output Terminals)

This terminal is used as a computer input or monitor output terminal. When used as a monitor output terminal, the computer (analog) signal input to the DVI-I terminal is output. Use a D-sub computer cable.

Mini S-sub 15-pin

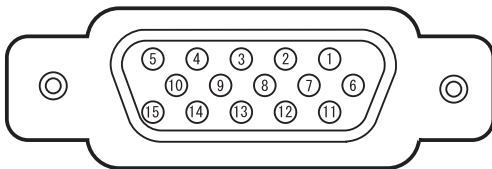

|   |                           |    |                         |
|---|---------------------------|----|-------------------------|
| 1 | R                         | 9  | +5 V power              |
| 2 | G                         | 10 | Ground (Vertical sync.) |
| 3 | B                         | 11 | Monitor ID0             |
| 4 | Monitor ID2               | 12 | DDC data                |
| 5 | Ground (Horizontal sync.) | 13 | Horizontal sync.        |
| 6 | Ground (R)                | 14 | Vertical sync.          |
| 7 | Ground (G)                | 15 | DDC clock               |
| 8 | Ground (B)                |    |                         |



The specification for the computer input terminal and that for the monitor output terminal are the same.

## Installing the Lens Cap

Install the lens cap in the following manner:  
Pass the supplied string through the lens cap string hole on the bottom of the projector, and then pass the other end of the string in the hole on the lens cap.

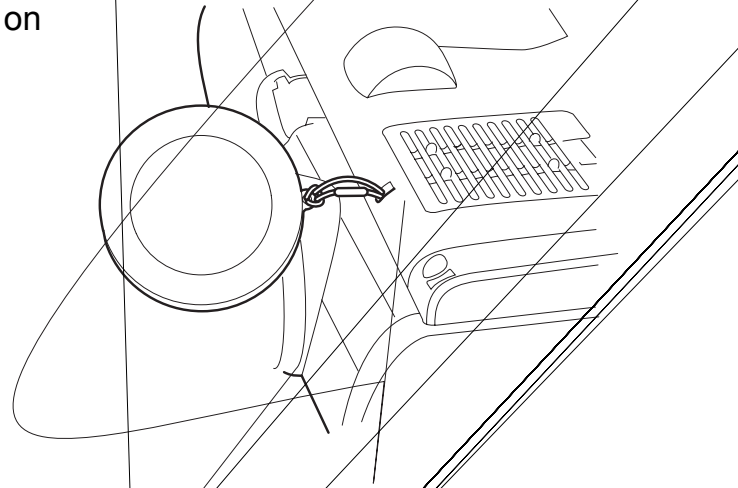

## Optional Parts

- Lamp
  - Ceiling Attachment
  - Ceiling Pipe (360 mm / 14.2")
  - Ceiling Pipe (550 mm / 21.7")
  - Ceiling Pipe (760 mm / 29.9")
  - Ceiling Plate
  - Mac Adapter
  - DVI Cable
- |           |           |
|-----------|-----------|
| Part No.: | RS-LP01   |
| Part No.: | RS-CL01   |
| Part No.: | RS-CL03*  |
| Part No.: | RS-CL04*  |
| Part No.: | RS-CL05*  |
| Part No.: | RS-CL02** |
| Part No.: | LV-AD02   |
| Part No.: | LV-CA29   |

\* This part is used to hang the projector from a high ceiling.

\*\* This part is used to join the ceiling pipe and the ceiling attachment.

For more information, refer to the instruction manual that comes with the ceiling attachment RS-CL01.

**CANON INC.** 30-2, Shimomaruko 3-chome, Ohta-ku, Tokyo 146-8501, Japan

**CANON U.S.A., INC.**

One Canon Plaza, Lake Success, NY 11042, U.S.A.

**CANON CANADA, INC.**

6390 Dixie Road Mississauga, Ontario L5T 1P7 Canada

**CANON LATIN AMERICA, INC.**

703 Waterford Way Suite 400 Miami, Florida 33126 U.S.A.

**CANON MEXICANA, S. de R.L. de C.V.**