

TOASTER OVEN BROILER WITH THIRD HEATING ELEMENT

***FOUR À CONVECTION NATURELLE AVEC CUISSON SIMULTANÉE
SUR DEUX NIVEAUX***

***HORNO DE CONVECCIÓN NATURAL CON COCCIÓN SIMULTÁNEA
EN DOS NIVELES***

***FORNO A CONVEZIONE NATURALE CON COTTURA SIMULTANEA
SU DUE LIVELLI***



CONTENTS

CHAP. 1	GENERAL	
1.1	Description and accessories	2
1.2	Important safeguards	3
1.3	Summary of operation	6
CHAP. 2	USING THE CONTROLS AND SETTING THE MODES	
2.1	Optional accessories	6
2.2	How to keep food warm "KEEP WARM"	6
2.3	Instructions for baking "BAKE"	6
2.4	Instructions for low baking "SLOW BAKE"	7
2.5	Instructions for baking with "DOUBLE BAKE/TOAST" function	8
2.6	Top brown "SINGLE BAKE/TOAST"	9
2.7	Instructions for broiling "BROIL"	9
2.8	Instructions for toasting with "DOUBLE BAKE/TOAST" function	10
CHAP. 3	CLEANING AND MAINTENANCE	11

ELECTRICAL CONNECTIONS

All it requires is a nearby 120 Volt 60 Hz three-prong grounded power outlet.

GROUNDING INSTRUCTIONS

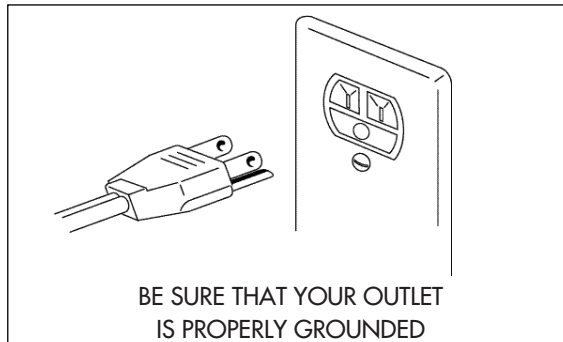

This appliance must be grounded. In the event of an electrical short circuit, grounding reduces the risk of electric shock by providing an escape wire for the electric current.

This appliance is equipped with a cord having a grounding wire with a grounding plug.

The plug must be plugged into an outlet that is properly installed and grounded.

WARNING: IMPROPER USE OF THE GROUNDING PLUG CAN RESULT IN A RISK OF ELECTRIC SHOCK.

If you are uncertain that your outlets are properly grounded, please contact a qualified electrician or serviceman.

If it is necessary to use an extension cord, use only a three-wire extension cord that has a 3-blade grounding plug, and a 3-slot outlet that will accept the plug on the appliance. The marked rating of the extension cord shall be equal to or greater than the electrical rating of the appliance.

- The cord length of this product has been selected to reduce the possibility of tangling in or tripping over a longer cord. If more cord length is needed, an extension cord may be used. It should be rated no less than 15 amps., 120 volts, and have Underwriters Laboratories/CSA listing.
- A six foot long, 15 amp. extension cord may be purchased from your local authorized service facility. When using a longer cord, be sure not to let it drape over the working area or dangle where someone could accidentally pull or trip over it.
- Handle the cord carefully for longer life; avoid jerking or straining the cord at the plug and appliance connections.

CHAPTER 1 - GENERAL

1.1 - DESCRIPTION OF THE OVEN AND THE ACCESSORIES

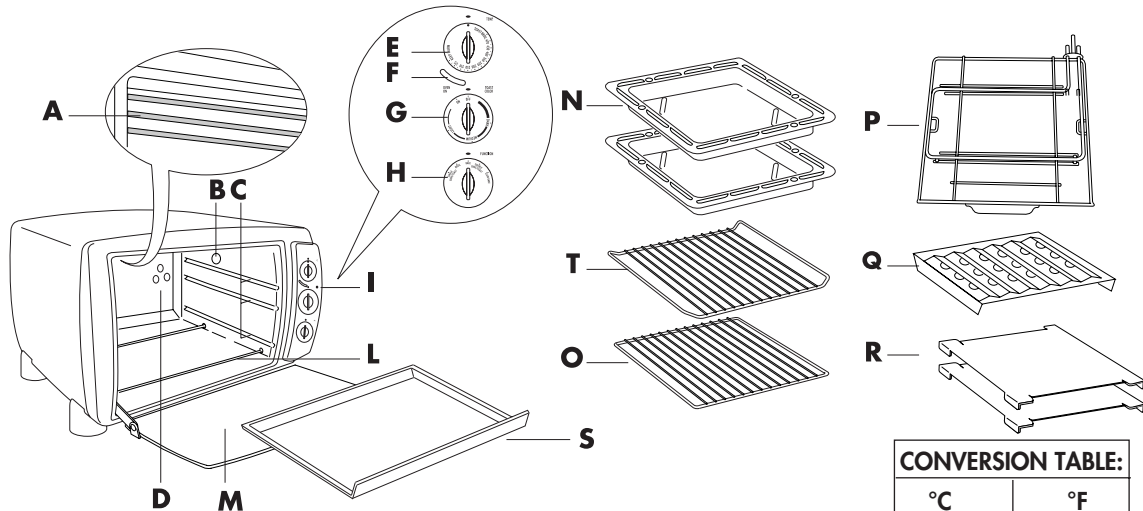

- A** Top heating element
- B** Oven light (if fitted)
- C** Side guides
- D** Third heating element connector
- E** Thermostat knob
- F** Pilot light
- G** On/off and toast programming knob

- H** Function selector knob
- I** Control panel
- L** Bottom heating element
- M** Glass door
- N** Two aluminum beke pans
- O** Wire rack
- P** Removable heating element
- Q** Broiling rack (if provided)
- R** Cookie sheet (if provided)
- S** Crumb tray
- T** Curve wire rack

CONVERSION TABLE:

°C	°F
120	250
135	275
150	300
163	325
177	350
190	375
205	400
218	425
233	450
240	470

REMOVABLE HEATING ELEMENT HOUSING

When not in use, the removable heating element (P) can be placed in the special housing under the oven as show in the figure right.

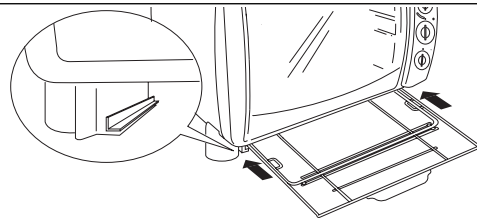

SIDE GUIDES

The oven has three guides to position baking pans and wire racks at different heights. Guide 2 is also used to insert the removable heating element for the "double oven" function, see page 6.

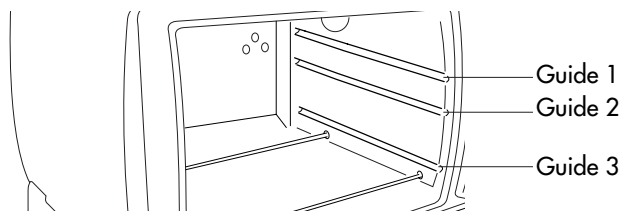

1.2 - IMPORTANT SAFEGUARDS

When using electrical appliances, basic safety precautions should always be followed, including the following:

1. **READ ALL INSTRUCTIONS.**
2. Do not touch hot surfaces. Use handles or dials.
3. Before using this appliance, move it two to four inches away from the wall or any object on the counter top. **Remove any object that may have been placed on top of the appliance.** Do not use on surfaces where heat may cause a problem.
4. To protect against electrical shock, do not place unit in or under water. See instructions for cleaning.
5. Close supervision is necessary when any appliance is used by or near children.
6. Unplug from outlet when not in use and before cleaning. Always turn the ON/OFF knob to "OFF" and the temperature dial to " ● " before unplugging.
7. Do not operate any appliance with a damaged cord or plug or after the appliance malfunctions, or has been damaged in any manner. Return appliance to the nearest authorized service facility for examination, repair or adjustment.
8. The use of accessory attachments not recommended by the appliance manufacturer may cause injuries.
9. Do not use outdoors.
10. Do not let cord hang over edge of table or counter, or touch hot surfaces.
11. Do not place on or near a hot gas or electric burner.
12. If the plug gets hot, please call a qualified electrician.
13. Do not use this appliance for other than intended use.
14. Use extreme caution when removing the oven pan or disposing of hot grease.
15. Do not clean with metal scouring pads. Pieces can break off the pad and touch electrical parts, creating a risk of electric shock.
16. To assure safe operation, oversized foods or utensils must not be inserted into the oven.
17. A fire may occur if this appliance is covered or touching flammable material, including curtains, draperies, walls, etc., when in operation.
18. CAUTION: Never leave the toaster-oven-broiler unattended when in use (especially when broiling and toasting).
19. When broiling, the oven pan, the broiling rack and wire rack must be used according to the instructions on page 10.
20. Extreme caution should be exercised when using containers other than oven proof metal glass or ceramic.
21. Do not store any materials, other than the manufacturer's recommended accessories, in the oven when not in use.
22. Do not place any of the following materials in the oven: paper, cardboard, plastic and the like.
23. Do not cover any part of the oven with metal foil. This will cause overheating of the oven.
24. To switch off the toaster-oven broiler, turn the ON/OFF knob to "OFF" and the temperature dial to " ● ".



● **THIS PRODUCT IS FOR HOUSEHOLD USE ONLY**

SAVE THESE INSTRUCTIONS

WARNING: Once having removed the appliance from the packaging, check that the door is intact. As the door is made from glass, it is fragile, and should be replaced if visibly chipped, scored or scratched. Furthermore, when using, cleaning or moving the appliance, do not slam or bang the door or pour cold liquids on the glass when the appliance is hot.

Chapter 1 - General

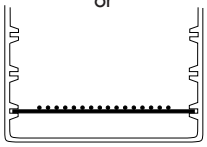
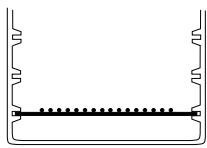
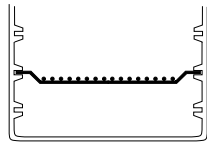
1.3 - SUMMARY OF OPERATION

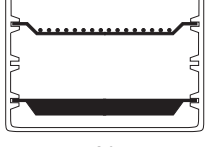
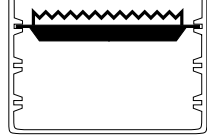
PROGRAM	POSITION ON/OFF AND TOAST PROGRAM KNOB	POSITION OF THERMOSTAT KNOB	POSITION OF FUNCTION SELECTOR KNOB	POSITION OF WIRE RACK AND ACCESSORIES	GUIDES	NOTES/TIPS
KEEP WARM (to keep warm the foods)	ON	KEEP WARM	BAKE	 or 	1 2 3 1 2 3	Turn to this setting to keep hot food warm. Do not hold food more than an hour or reheat cold food. If not hot enough for serving turn thermostat knob up.
BAKE (to bake only one dish)	ON	UP TO 470° F	BAKE	 or  or  or 	1 2 3 1 2 3 1 2 3	Ideal for meat, pizza, cakes, baked casseroles, fruit desserts, fish, stuffed vegetables, puddings and other moist foods that do not require browning and crisping.
BROIL (to broil or grill the foods)	ON	TOAST BROIL	BROIL	 or 	1 2 3 1 2 3	Ideal for all types of traditional grilling; hamburgers, hot dogs, kebabs, toast, etc. Place the food directly on the wire rack. The aluminum bake pan is used to collect any drops of fat. Or place the broiling rack (Q) (if included) in the aluminum bake pan (N).

Chapter 1 - General

PROGRAM	POSITION ON/OFF AND TOAST PROGRAM KNOB	POSITION OF THERMOSTAT KNOB	POSITION OF FUNCTION SELECTOR KNOB	POSITION OF WIRE RACK AND ACCESSORIES	GUIDES	NOTES/TIPS
DOUBLE BAKE/TOAST (to bake/toast simultaneously on two levels)	ON	UP TO 470° F	DOUBLE BAKE/TOAST		<p>1</p> <p>2</p> <p>3</p> <p>1</p> <p>2</p> <p>3</p>	Use the two wire racks (O-T as show in figure) to cook two frozen pizzas only; For all other foods, use the aluminum bake pan (N).
TOAST (to toast simultaneously on two levels)	RANGE OF LIGHT TO DARK	TOAST BROIL	DOUBLE BAKE/TOAST		<p>1</p> <p>2</p> <p>3</p>	Set the ON/OFF knob to the color desired. Some breads, muffins etc. will take longer than others. Reset knob if results are too light. Place the bread to be toasted following instructions.
SLOW BAKE (to cook delicate food using only the lower heating element)	ON	UP TO 470° F	SLOW BAKE		<p>1</p> <p>2</p> <p>3</p> <p>1</p> <p>2</p> <p>3</p>	Use the aluminum bake pan, sliding it directly into the lower guide, or a pan on the wire rack (O) in the lower guide.
TOP BROWN (to top brown the food)	RANGE OF LIGHT TO DARK	TOAST BROIL	SINGLE BAKE/TOAST		<p>1</p> <p>2</p> <p>3</p> <p>1</p> <p>2</p> <p>3</p>	Ideal for sandwich, hot dogs etc.

= aluminum bake pan (N) = Wire rack (O) = Curve wire rack (T) = Removable heating element (P)

CHAPTER 2 - USING THE CONTROLS AND SETTING THE MODES

2.1 - OPTIONAL ACCESSORIES (NOT FOR ALL MODELS)

COOKIE SHEET (R)

Must be placed directly on the wire rack. Indispensable for baking biscuits and pastries.

BROILING RACK (Q)

may be inserted inside of the aluminum bake pan (N):

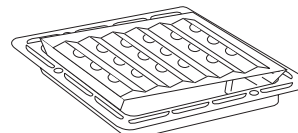

2.2 - HOW TO KEEP FOOD WARM "KEEP WARM"

Place the food to be kept warm on the wire rack (O)

- Set the thermostat knob (E) to the KEEP WARM position.
- Set the ON/OFF knob (G) to ON position.
- Set the function selector knob (H) to the BAKE position.

Once the KEEP WARM function is no longer needed, turn the thermostat knob (E) to "●" and the ON/OFF knob (G) to OFF.

This feature is designed to keep foods warm, after they are cooked for short periods of time without overcooking. We do not recommend keeping foods warm for prolonged periods or using this feature to reheat frozen or cold foods.

2.3 - INSTRUCTIONS FOR BAKING "BAKE"

You can bake foods in your oven, just as in your regular oven. Casseroles or baking dishes may be placed directly on the removable wire rack (O) or on the curved wire rack (T). Use the aluminum bake pan (N) (or cookie sheet, if provided) to bake such items as cookies, biscuits, rolls and uncovered casserole dishes.

- Close the door
- Set the thermostat knob (E) to the desired position/temperature
- Set the ON/OFF knob (G) to ON position.
- Set the function selector knob (H) to the BAKE position.

When baking is finished turn the thermostat knob (E) to "●" and the ON/OFF knob (G) to OFF.

NOTE:

We do not recommend the use of glass covers on casseroles.

Glass cooking dishes should never be closer than one inch from the heating element.

During the bake and toast function, do not put the dripping pan (or any other accessory/container) directly on the lower heating element.

HELPFUL BAKING HINTS

To obtain best performance from this toaster-oven-broiler:

- Do not overfill the oven. Whenever possible, place foods in center of oven.
- Avoid opening the door too frequently to prevent heat loss.
- Foil may be used to cover the baking dish or pan. Be sure the ends of foil are tucked closely against the edge of the baking dish/pan.

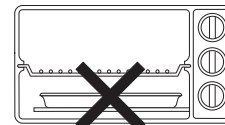

CHAPTER 2 - USING THE CONTROLS AND SETTING THE MODES

TEMPERATURE AND TIME FOR TYPICAL FOODS (baking and roasting)

The suggested temperature and times will vary depending on the temperature of the food placed in the oven, the quantity and personal preference. Times given for meat and poultry are for refrigerator temperature. Add five minutes for preheating the oven. In order to avoid overcooking when using for the first time we suggest you to set a low temperature. As you use the oven, the best settings will become familiar.

Food	Temperature setting	Approximate time	Notes and tips (For wire rack position refer to table on page 4)
Whole chicken 2.5-3 lbs. (1-1,5 kg.) Unstuffed	400 °F	80-90 min. or until internal temperature of 175 °F in thigh and breast	Turning at half of cooking time is not required. It is possible to cook also above the broiling rack inverted (lower position) inside the oven pan, in order to reduce spattering.
Pork loin or Rib Roast 2-3 lbs (1-1,5 kg.)	400 °F	80-90 min. or until internal temperature of 170 °F is reached	Roast as for whole chicken.
Beef Sirloin or Rib Roast 3 lbs (1,5 kg.)	400 °F	60-70 min. or until tender and brown	No turning is needed.
Meat loaf 2-2.5 lbs (900/1300 gr.)	350 °F	50-60 min.	Use the oven pan. No turning is needed. Mix and beat together 1,5-2 lbs (700 g - 1 kg) at minced meat (beef). With eggs, bread-crumbs, salt, pepper and flavoring.
Baking potatoes 3-4 large cut into pieces	400 °F	50-60 min.	Cut the potatoes into small pieces, use the oven pan, mix three times when cooking and after at least 20 minutes.
Loaf cakes	320 °F	Follow traditional recipe timing (slightly lowered)	Use metal rectangular molds.
Pies, uncovered	320 °F	Follow traditional recipe timing (slightly lowered)	Use metal moulds for cakes
Cookies: rolled and cut, sliced, formed	375 °F	10-20 min.	Insert the rack as for TOASTING function. Use the cookie sheet (if provided) or the aluminum bake pan.

2.4 - INSTRUCTIONS FOR LOW BAKING "SLOW BAKE"

Ideal for pastries and cakes with icing. Good results are also achieved when completing the cooking of the base of foods or for cooking that requires heat above all at the bottom. Insert the dripping pan or wire rack (O) (with a pan on top) in guide 3.

- Turn the function selector knob (H) to position SLOW BAKE.
- Select the desired temperature using the thermostat knob (E).
- Turn the ON/OFF and toast programming knob (G) to the time desired.

A bell will ring when the set time has elapsed; if the food being kept warm is served before the end of the set time, manually turn the ON/OFF and toast programming knob (G) to position OFF.

2.5 - INSTRUCTIONS FOR BAKING WITH "DOUBLE BAKE/TOAST" FUNCTION

Insert the removable heating element (P) into the central guide (2) as shown in the figure below. **Make sure the prongs of the removable heating element are correctly and completely inserted into the connector (D).**

- Rotate the function selector knob (H) into the DOUBLE BAKE/TOAST position.
- Select the required temperature using the thermostat knob (E).
- Turn the ON/OFF and timer knob (G) to the required time.

Wait for the oven to reach the required temperature (the indicator light goes out), then insert the two aluminum bake pans or wire racks (O and T) into guides 1 and 3 as show in figure on page 6. The end of cooking will be indicated by a beep.

Each time you finish double oven cooking:

- Turn the thermostat knob (E) to the "●" position and if cooking ends before the time set, turn the timer knob (G) to the "0" position.
- NEVER rest anything directly on the removable heating element (P), but always use the two wire racks and aluminum bake pans provided inserted in guides 1 and 3.
- When using the wire racks we suggest you to turn over the food halfway.

Wait for the oven to cool down before removing the heating element (P) and replacing it in the special housing.

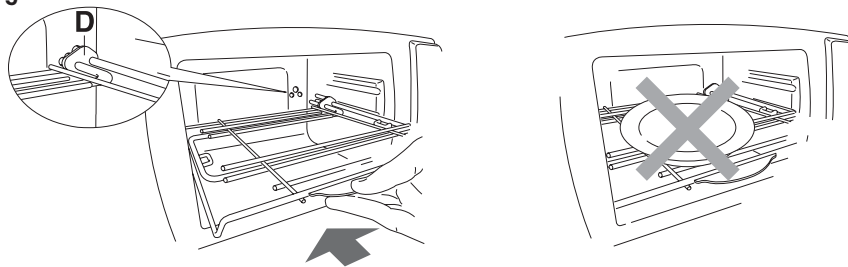

RECIPE	QUANTITY	THERMOSTAT KNOB	TIME	WIRE RACK/ALUMINUM BAKE PAN POSITION	OBSERVATIONS AND TIPS
FRESH PIZZAS	1000 g 2 lbs	430 °F	30 min.	1 and 3	Use the two aluminum bake pans (N) provided
FROZEN PIZZAS	2000 g 4-4.5 lbs	430 °F	17 min.	1 and 3	Use the two wire racks (O-T) provided. Turn over halfway
PIES	1400 g 3 lbs	400 °F	30 min.	1 and 3	Use the two aluminum bake pans (N) provided
CHICKEN	1400 g 3 lbs	430 °F	60 min.	1 and 3	Use the two aluminum bake pans (N) provided
KEBABS	1200 g 2.5-3 lbs	430 °F	45 min.	1 and 3	Use the two aluminum bake pans (N) provided
CHICKEN AND POTATOES	1400 g 3 lbs	430 °F	60 min.	1 and 3	Use the two aluminum bake pans (N) provided
BAKED POTATOES	1200 g 2.5-3 lbs	430 °F	60 min.	1 and 3	Use the two aluminum bake pans (N) provided
BAKED BEAN	2000 g 4-4.5 lbs	400 °F	40 min.	1 and 3	Use the two aluminum bake pans (N) provided
COURGETTES WITH TUNA	2000 g 4-4.5 lbs	400 °F	45 min.	1 and 3	Use the two aluminum bake pans (N) provided
TARTS	1500 g 3-3.5 lbs	400 °F	45 min.	1 and 3	Use the two aluminum bake pans (N) provided
MUFFINS	1200 g 2.5-3 lbs	400 °F	20 min.	1 and 3	Use the two aluminum bake pans (N) provided

Add about 10 minutes to the cooking time for preheating the oven.

2.6 - TOP BROWN "SINGLE BAKE/TOAST"

Top browning is ideal for melting, crisping food surfaces. Use it for open face sandwiches, pre-buttered muffins or browning cooked casseroles.

- Place the food on the aluminum bake pan or on the wire rack (O) (or cookie sheet, if provided).
- Close the door, both the function selector knob (H) and thermostat knob (E) to BROIL.
- Turn the ON/OFF and toast programming knob (G) to MEDIUM or to ON (for longer browning times).

When experimenting with new uses, watch the food to avoid overbrowning.

When the browning cycle is completed (top surface with desired color) turn the thermostat knob (E) to "●" and the ON/OFF and toast programming knob (G) to OFF.

2.7 - INSTRUCTIONS FOR BROILING "BROIL"

Always use the aluminum bake pan with the broiling rack (if provided) for broiling. No preheating of the broiler is necessary.

Do not leave the broiler unattended when in use. Before using the broiler for the first time and after use, wash the pan and the rack with warm, sudsy water. Do not cover the oven wire rack with foil.

This prevents fat and oils from draining, causing spatter and smoking, and also restricts air circulation for proper ventilation.

- Place the curved wire rack (T) as shown in the table on page 5.
- Place the food to be broiled on the broiling rack (Q) (if provided) (set inside the aluminum bake pan), then put the assembly on the wire rack.
- Always leave the oven door open to the stop position (as shown below).
- Turn the thermostat knob (E) and the function selector knob (H) to BROIL.
- Turn the ON/OFF and toast programming knob (G) to ON.
- When broiling is finished, turn the ON/OFF and toast programming knob (G) to the OFF position and the thermostat knob (E) to the "●" position. Care should be taken when turning food, removing the aluminum bake pan and disposing of the grease collected while broiling. Use oven mitts.

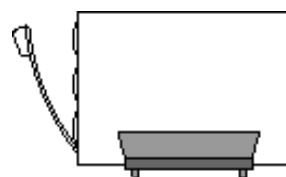

NOTE:

While smoke is an inherent characteristic of good broiling, the following tips should eliminate or greatly reduce smoking:

Trim excess fat from meat and score the edges to prevent curling. Dry meat, fish and poultry surfaces with paper towel.

For best results, thaw frozen meats before broiling. These two precautions will reduce or eliminate smoke from the broiler.

Placing the food on the broiling rack allows the juices and fat to drip into the dripping pan and decreases spattering while broiling.

If frozen steaks and chops are broiled, allow 1 and a half to 2 times the required broiling time as that required for unfrozen meat.

If grease "pops" during broiling, turn the temperature control dial to a lower setting.

Remove grease from the pan and wash the pan and broiling rack after use.

The broiler should be cleaned inside after each use. Too much grease accumulation causes smoking. Use any non-abrasive cleaner and hot water.

For very thick steaks and other thick foods, we recommend using the lower broiling rack position.

Since fish is non-fatty it can be broiled directly on the oven pan. Broil until it flakes easily with a fork. Thin fillets do not need to be turned.

2.8 - INSTRUCTIONS FOR TOASTING WITH "DOUBLE BAKE/TOAST" FUNCTION

The capacity of the wire racks (O and T) allows you to toast of 6 slices of bread per rack. However better results are obtained with 8 slices (4+4).

For toasting, place the slices of bread as shown below:

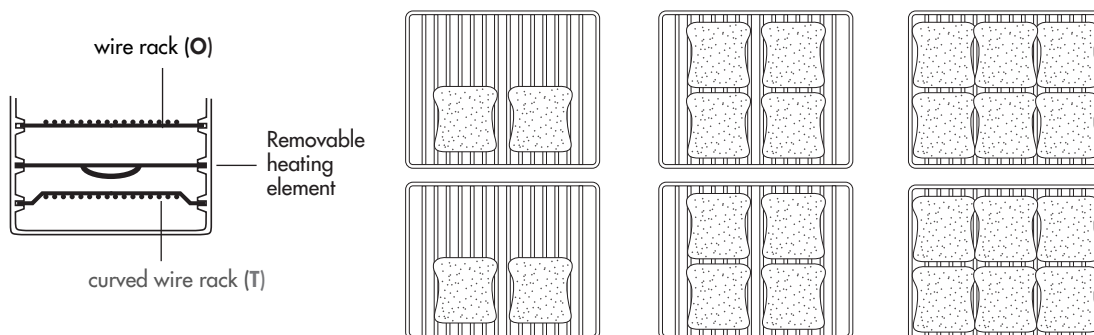

- For consecutive toasting, turn the ON/OFF and toast programming knob (G) to a LIGHT position. Always use the oven wire rack for toasting bread, sandwiches, English muffins, shelf foods and frozen waffles automatically.
- Place the wire racks (O-T) as shown in the table on page 6.
- Center the food to be toasted on the wire rack. Close the door.
- Set the thermostat knob (E) to TOAST BROIL position and the function selector knob to DOUBLE BAKE/TOAST.
- The ON/OFF and toast programming knob (G) can be set clockwise for LIGHT, MEDIUM or DARK toast or any shade desired in between.
When using the toaster-oven-broiler for the first time, set the ON/OFF and toast programming knob (G) to a MEDIUM position. Toast a few pieces of bread to check for desired brownness. If necessary, adjust the control to suit your preference.
- When toasting, both the top and bottom heating element switch on to brown both sides of the food at the same time. Condensation may build up on the inside of the glass door. This is normal.
The condensation will evaporate during the toasting cycle.
- A ring indicates the end of the set time. The toasting cycle has been completed and the heating elements will shut off automatically. Turn the thermostat knob (E) to the "●" position.

NOTE:

This toaster-oven-broiler is capable of toasting in a wide range of colors, automatically from light to dark. However, if you prefer a lighter shade of toast, simply interrupt the automatic toast cycle by turning the ON/OFF and toast programming knob (G) to OFF. This will shut the unit off without damaging the oven.

If you prefer a darker shade, restart the toasting cycle by turning the ON/OFF and toast programming knob (G) clockwise until the desired color is obtained.

Then switch the thermostat knob (E) off manually and the ON/OFF and toast programming knob (G) as described earlier.

As you use the oven, the best settings for favorite breads will become familiar.

HINTS FOR TOASTING SUCCESS

Heavier breads and frozen breads will require a darker setting. One slice of bread will require a lighter setting than several slices.

CHAPTER 3 - CLEANING AND MAINTENANCE

Always unplug the toaster-oven-broiler and allow it to cool before cleaning. This unit has been designed and engineered with your safety in mind. To assure maximum safe operation, keep unit free of grease and build up of food particles.

1. Remove the wire oven rack.
2. To clean the inside walls, use a damp cloth and a mild liquid soap solution. Never use harsh abrasives, corrosive products or spray detergents.
 - NOTE:
Do not clean interior with metal scouring pads. Pieces can break off and touch electrical parts, creating risk of electrical shock.
3. To clean the glass door, use a glass cleaner or a damp cloth. Wipe dry with a clean cloth.
4. To clean the exterior finish, use a damp, sudsy cloth. For stubborn stains, a non-abrasive liquid cleaner or spray glass cleaner may be used. Do not use metal scouring pads, as they might mar the finish. Always remove cleaning agents by polishing with a dry cloth.
5. The wire rack, the oven pan and the broiling rack may be washed like other kitchen ware.

IF YOUR OVEN HAS A CRUMB TRAY:

Slide the crumb tray out from under the bottom of your oven (see figure). Wash by hand. Should the food particles be difficult to remove, rinse the crumb tray with hot soapy water and if necessary, scour it delicately, without scratching it.

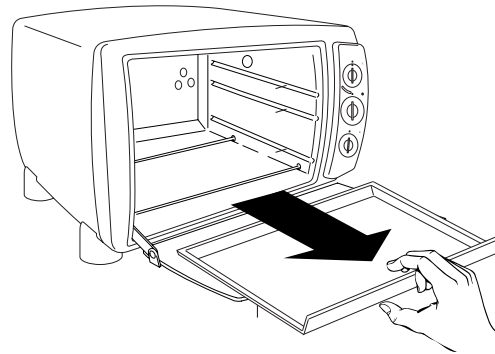

OTHER SERVICING

Any servicing requiring disassembly should be performed by an authorized service representative.

OVEN LIGHT

The oven light (B) is always on when the oven is on. To replace the bulb, proceed as follows:

- unplug the appliance from the power socket
- unscrew the protective glass cover (X), by turning it counter-clockwise, and replace the bulb (Y) with a new one of the same type (see Figure). Replace the protective glass cover (X).

Only use bulbs suitable for ovens (T300°C)

Note: The oven can still be used even if the bulb is burned-out

