

3M

X90

Multimedia Projector Operator's Guide

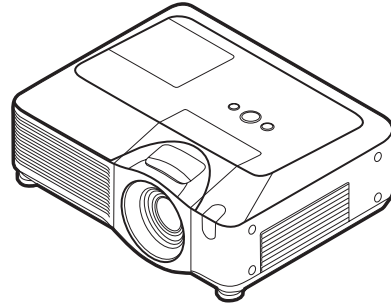

Thank you for purchasing this projector.

⚠ WARNING ▶ Before using this product, please read the "Product Safety Guide" and related manuals to ensure the proper use of this product. After reading them, store them in a safe place for future reference.

About this manual

Various symbols are used in this manual. The meanings of these symbols are described below.

⚠ WARNING This symbol indicates information that, if ignored, could possibly result in personal injury or even death due to incorrect handling.

⚠ CAUTION This symbol indicates information that, if ignored, could possibly result in personal injury or physical damage due to incorrect handling.

 Please refer to the pages written following this symbol.

NOTE • The information in this manual is subject to change without notice.

- The manufacturer assumes no responsibility for any errors that may appear in this manual.
- The reproduction, transfer or copy of all or any part of this document is not permitted without express written consent.

Trademark acknowledgment

- Mac is registered trademarks of Apple Computer, Inc.
- VESA and SVGA are trademarks of the Video Electronics Standard Association.
- Windows is a registered trademark of Microsoft Corporation.
-  is a trademark of SRS Labs, Inc.
- WOW technology is incorporated under license from SRS Labs, Inc.

All other trademarks are the properties of their respective owners.

Content

Content

About this manual	1	(EASY MENU continued)	
Content	2	LANGUAGE, Go to Advanced Menu...	
Projector features	3	PICTURE menu	26
Preparations	3	BRIGHTNESS, CONTRAST, GAMMA, COLOR TEMP, COLOR, TINT, SHARPNESS, ACTIVE IRIS, MY MEMORY	
Contents of package	3	IMAGE menu	29
Fastening the lens cover	3	ASPECT, OVER SCAN, V POSITION, H POSITION, H PHASE, H SIZE, AUTO ADJUST EXECUTE	
Part names	4	INPUT menu	31
Projector	4	PROGRESSIVE, VIDEO NR, 3D-YCS, COLOR SPACE, COMPONENT, VIDEO FORMAT, M1-D, FRAME LOCK, RGB IN, RESOLUTION	
Control panel	5	SETUP menu	35
Rear panel	5	AUTO KEYSTONE  EXECUTE, KEYSTONE  , KEYSTONE  , WHISPER, MIRROR	
Remote control	6	AUDIO menu	37
Setting up	7	VOLUME, TREBLE, BASS, SRS WOW, SPEAKER, AUDIO	
Arrangement	8	SCREEN menu	38
Adjusting the projector's elevator	9	LANGUAGE, MENU POSITION, BLANK, START UP, MyScreen, MyScreen Lock, MESSAGE, SOURCE NAME	
Using the security bar and slot	9	OPTION menu	42
Connecting your devices	10	AUTO SEARCH, AUTO KEYSTONE  ,	
Connecting power supply	12	AUTO ON, AUTO OFF, LAMP TIME, FILTER TIME, MY BUTTON, SERVICE, SECURITY	
Remote control	13	NETWORK menu	53
Laser pointer	13	DHCP, IP ADDRESS, SUBNET MASK, DEFAULT GATEWAY, TIME DIFFERENCE, DATE AND TIME, e-SHOT, INFORMATION, SERVICE	
Putting batteries	13	Network functions	55
About the remote control signal	14	Maintenance	56
Changing the frequency of remote control signal	14	Lamp	56
Using as a wired remote control	15	Air filter	58
Using as a simple PC mouse & keyboard	15	Internal clock battery	60
Power on/off	16	Other care	61
Turning on the power	16	Troubleshooting	62
Turning off the power	16	Related messages	62
Operating	17	Regarding the indicator lamps	63
Adjusting the volume	17	Phenomena that may be easy to be mistaken for machine defects	65
Temporarily muting the sound	17	Specifications	68
Selecting an input signal	17	Technical (English only) (Please see the end of this book, although only in English.)	
Searching an input signal	18		
Selecting an aspect ratio	18		
Adjusting the zoom and focus	19		
Adjusting the lens shift	19		
Using the automatic adjustment feature	19		
Adjusting the position	20		
Correcting the keystone distortions	20		
Using the magnify feature	21		
Freezing the screen	21		
Temporarily blanking the screen	22		
Using the menu function	23		
EASY MENU	24		
ASPECT, AUTO KEYSTONE  EXECUTE, KEYSTONE  , KEYSTONE  , PICTURE MODE, BRIGHTNESS, CONTRAST, COLOR, TINT, SHARPNESS, WHISPER, MIRROR, RESET, FILTER TIME,			

Features

to project various picture signals onto a screen. This
a minimal amount of space for installation and can produce
from even a short distance.

Package

with the items shown below. Contact immediately your
.

Fasten

To :
the

the lens cover to the projector using

1.

2.

3. Push the rivet into the rivet hole.

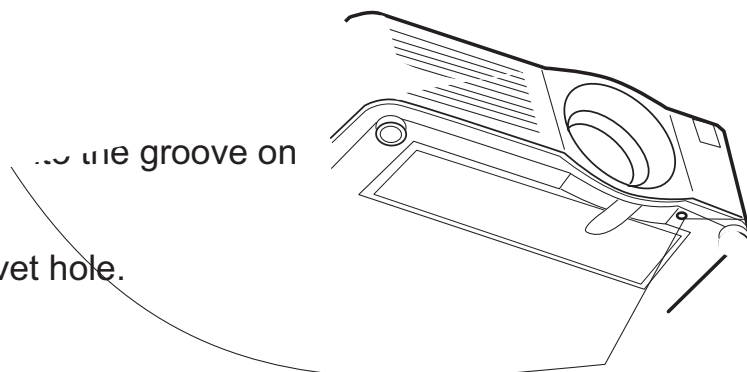

Part names

Projector

(1) Speakers (x 4) (📖37).

(2) Focus ring (📖19)

(3) Zoom ring (📖19)

(4) Lamp door (📖56)

The lamp unit is inside.

(5) Lens shift cover (📖19)

(6) Horizontal lens shift dial (📖19)

(7) Vertical lens shift dial (📖19)

(8) Front cover

(9) Lens (📖61)

(10) Lens cover (📖3)

(11) Remote sensors (x 3) (📖14)

(12) Elevator feet (x 2) (📖9)

(13) Elevator knobs (x 2) (📖9)

(14) Filter cover (📖58)

The air filter and intake vent are inside.

(15) Exhaust vents

(16) Intake vents

(17) Rivet hole (📖3)

(18) Handle

(19) Battery cover (📖60)

(20) Control panel (📖5)

(21) Rear panel (📖5)

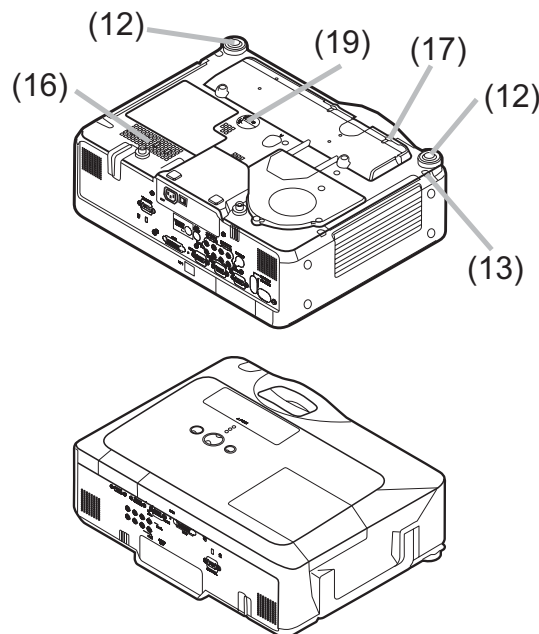

⚠️WARNING ▶HOT! : Do not touch around the lamp door and the exhaust vents during use or just after use, since it is too hot.

▶ Do not look into the lens or vents while the lamp is on, since the strong light is not good for your eyes.

▶ Do not grab the front cover to hold the projector up, since the projector may drop down.

⚠️CAUTION ▶ Maintain normal ventilation to prevent the projector from heating up. Do not cover, block or plug up the vents. Do not place anything that can stick or be sucked to the vents, around the intake vents. Clean the air filter periodically.

▶ Do not handle the elevator knobs without holding the projector, since the projector may drop down.

Control panel

(1) STANDBY/ON button (

Part names

Remote control

- (1) Laser pointer (📖13)
It is a beam outlet.
- (2) LASER INDICATOR (📖13)
- (3) LASER button (📖13)
- (4) STANDBY/ON button (📖16)
- (5) VOLUME button (📖17)
- (6) MUTE button (📖17)
- (7) VIDEO button (📖18)
- (8) RGB button (📖17)
- (9) SEARCH button (📖18)
- (10) AUTO button (📖19)
- (11) ASPECT button (📖18)
- (12) POSITION button (📖20)
- (13) KEYSTONE button (📖20)
- (14) MAGNIFY - ON button (📖21)
- (15) MAGNIFY - OFF button (📖21)
- (16) FREEZE button (📖21)
- (17) BLANK button (📖22)
- (18) MY BUTTON - 1 button (📖44)
- (19) MY BUTTON - 2 button (📖44)
- (20) MENU button (📖23)
- (21) Lever switch (📖23) : acting 3 functions as below.
Cursor button ▲ : to slide toward the side marked ▲ .
Cursor button ▼ : to slide toward the side marked ▼ .
ENTER button : to push down the center point.
- (22) Cursor button ◀ (📖23)
- (23) Cursor button ▶ (📖23)
- (24) RESET button (📖23)
- (25) ESC button (📖23)
- (26) Mouse left button (📖15)
- (27) Mouse right button (📖15)
- (28) PAGE UP button (📖15)
- (29) PAGE DOWN button (📖15)
- (30) Wired remote control port (📖15)
- (31) Battery cover (📖13)
- (32) Battery holder (📖13)
- (33) Frequency switch (📖14)

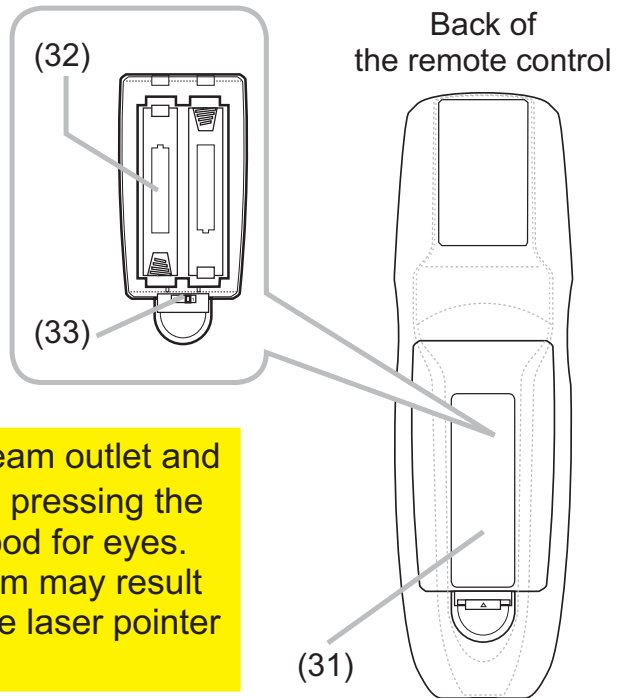
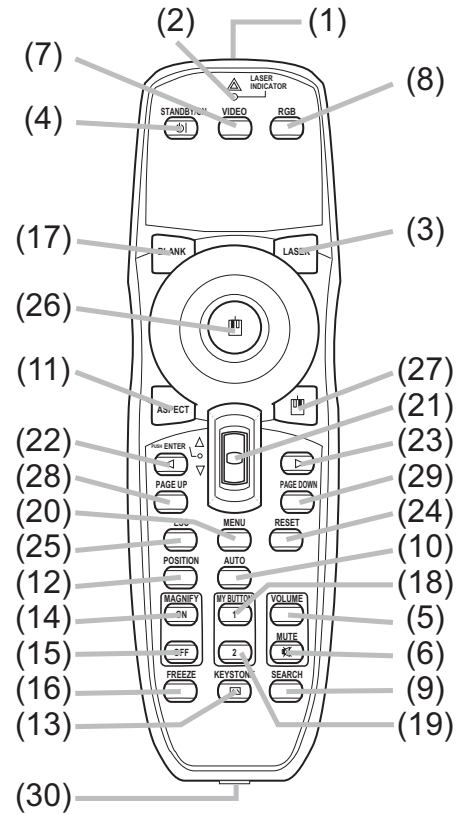

⚠WARNING ▶ Do not look into the beam outlet and point the beam at people and pets while pressing the LASER button, since the beam is not good for eyes.

⚠CAUTION ▶ Note that the laser beam may result in hazardous radiation exposure. Use the laser pointer only for pointing on the screen.

Setting up

Install the projector according to the environment and manner the projector will be used in.

⚠WARNING ► Place the projector in a stable horizontal position. If the projector falls or is knocked over it could cause injury and/or damage to the projector. Using a damaged projector could then result in fire and/or electric shock.

- Do not place the projector on an unstable, slanted or vibrational surface such as a wobbly or inclined stand.
- Do not place the projector on its side, front or rear position.
- Consult with your dealer before a special installation such as suspending from a ceiling.

► Place the projector in a cool place, and ensure that there is sufficient ventilation. The high temperature of the projector could cause fire, burns and/or malfunction of the projector.

- Do not stop-up, block or otherwise cover the projector's vents.
- Keep a space of 30 cm or more between the sides of the projector and other objects such as walls.
- Do not place the projector on metallic thing or anything weak in heat.
- Do not place the projector on carpet, cushions or bedding.
- Do not place the projector in direct sunlight or near hot objects such as heaters.
- Do not place anything near the projector lens or vents, or on top of the projector.
- Do not place anything that may be sucked into or stick to the vents on the bottom of the projector. This projector has some intake vents also on the bottom.
- Do not place the projector anyplace where it may get wet. Getting the projector wet or inserting liquid into the projector could cause fire, electric shock and/or malfunction of the projector.
- Do not place the projector in a bathroom or the outdoors.
- Do not place anything containing liquid near the projector.

⚠CAUTION ► Avoid placing the projector in smoky, humid or dusty place. Placing the projector in such places could cause fire, electric shock and/or malfunction of the projector.

- Do not place the projector near humidifiers, smoking spaces or a kitchen.
- Position the projector to prevent light from directly hitting the projector's remote sensor.

Setting up

Arrangement

Refer to the illustrations and tables below to determine screen size and projection distance.

The values shown in the table are calculated for a full size screen: 1024×768

(a) Screen size (diagonal)

(b) Projection distance (±10%)

(c) Screen height (±10%), when the vertical lens shift is set full upward (📖19)

On a horizontal surface

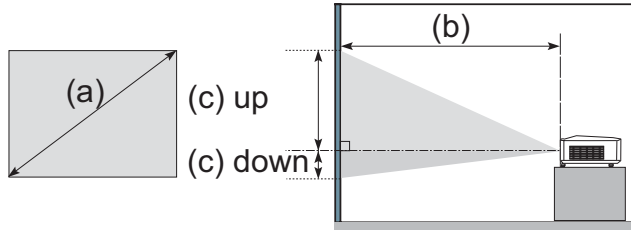

Suspended from the ceiling

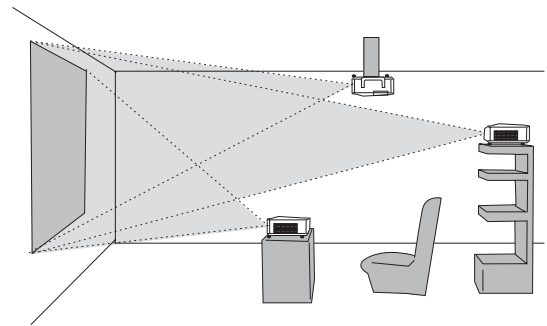
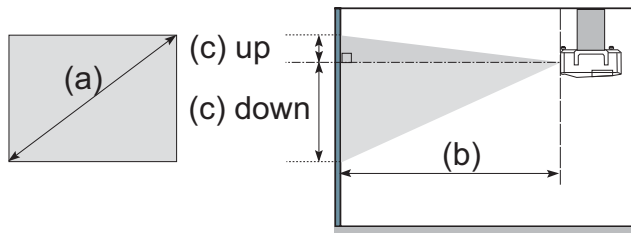

- Keep a space of 30 cm or more between the sides of the projector and other objects such as walls.
- Consult with your dealer before a special installation such as suspending from a ceiling.

(a) Screen size [inch (m)]	4 : 3 screen				16 : 9 screen			
	(b) Projection distance [m (inch)]		(c) Screen height [cm (inch)]		(b) Projection distance [m (inch)]		(c) Screen height [cm (inch)]	
	min.	max.	down	up	min.	max.	down	up
30 (0.8)	0.9 (35)	1.1 (42)	5 (2)	41 (16)	1.0 (38)	1.2 (46)	-1 (0)	39 (15)
40 (1.0)	1.2 (47)	1.4 (57)	6 (2)	55 (22)	1.3 (51)	1.6 (62)	-2 (-1)	51 (20)
60 (1.5)	1.8 (71)	2.2 (86)	9 (4)	82 (32)	2.0 (78)	2.4 (94)	-2 (-1)	77 (30)
70 (1.8)	2.1 (83)	2.6 (100)	11 (4)	96 (38)	2.3 (91)	2.8 (110)	-3 (-1)	90 (35)
80 (2.0)	2.4 (96)	2.9 (115)	12 (5)	110 (43)	2.6 (104)	3.2 (126)	-3 (-1)	103 (41)
90 (2.3)	2.7 (108)	3.3 (130)	14 (5)	123 (49)	3.0 (117)	3.6 (141)	-4 (-1)	116 (46)
100 (2.5)	3.0 (120)	3.7 (144)	15 (6)	137 (54)	3.3 (131)	4.0 (157)	-4 (-2)	129 (51)
120 (3.0)	3.7 (144)	4.4 (174)	18 (7)	165 (65)	4.0 (157)	4.8 (189)	-5 (-2)	154 (61)
150 (3.8)	4.6 (181)	5.5 (217)	23 (9)	206 (81)	5.0 (197)	6.0 (237)	-6 (-2)	193 (76)
200 (5.1)	6.1 (241)	7.4 (291)	30 (12)	274 (108)	6.7 (263)	8.0 (317)	-8 (-3)	257 (101)
250 (6.4)	7.7 (302)	9.2 (364)	38 (15)	343 (135)	8.4 (329)	10.1 (396)	-10 (-4)	322 (127)
300 (7.6)	9.2 (363)	11.1 (437)	46 (18)	411 (162)	10.0 (395)	12.1 (476)	-12 (-5)	386 (152)
350 (8.9)	10.8 (424)	13.0 (510)	53 (21)	480 (189)	11.7 (462)	14.1 (556)	-15 (-6)	450 (177)

Adjusting the projector's elevator

When the place to put the projector is slightly uneven to the left or right, use the elevator feet to place the projector horizontally.

Using the feet can also tilt the projector in order to project at a suitable angle to the screen, elevating the front side of the projector within 8 degrees.

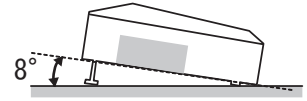

This projector has 2 elevator feet and 2 elevator knobs. An elevator foot is adjustable while pulling up the elevator knob on the same side as it.

1. Holding the projector, pull the elevator knobs up to loose the elevator feet.
2. Position the front side of the projector to the desired height.
3. Release the elevator knobs in order to lock the elevator feet.
4. After making sure that the elevator feet are locked, put the projector on the screen.
5. If necessary, the elevator feet can be adjusted. Hold the projector and adjust the feet.

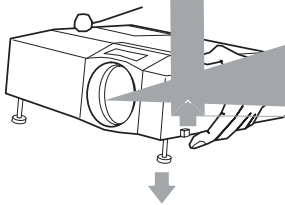

To loose an elevator foot, pull up the elevator knob on the same side as it.

To finely adjust, twist the foot.

⚠ CAUTION ▶ Do not handle the elevator knobs without holding the projector, since the projector may drop down.

▶ Do not tilt the projector other than it elevating its front within 8 degrees using the adjuster feet. A tilt of the projector exceeding the restriction could cause malfunction or shortening the lifetime of consumables, or the projector itself.

Using the security bar and slot

A commercial anti-theft chain or wire up to 10 mm in diameter can be attached to the security bar on the projector.

Also this product has the security slot for the Kensington lock.

For details, see the manual of the security tool.

⚠ CAUTION ▶ Do not use the security bar and the security slot to prevent the projector from falling down, since it is not designed for it.

NOTE • The security bar and the security slot are not comprehensive theft prevention measures. They are intended to be used as supplemental theft prevention measure.

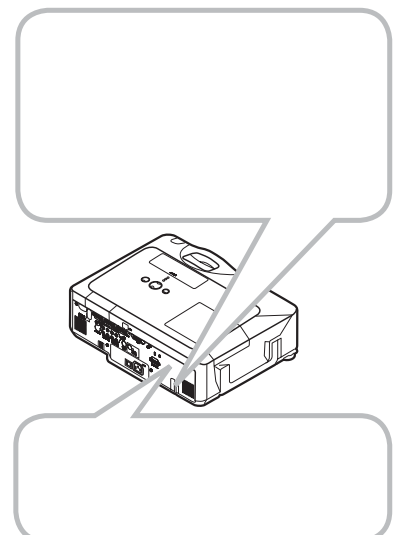

Setting up

Connecting your devices

Be sure to read the manuals for devices before connecting them to the projector. Make sure that all the devices are suitable to be connected with this product, and prepare the cables required to connect.

Please refer to the following illustrations to connect them.

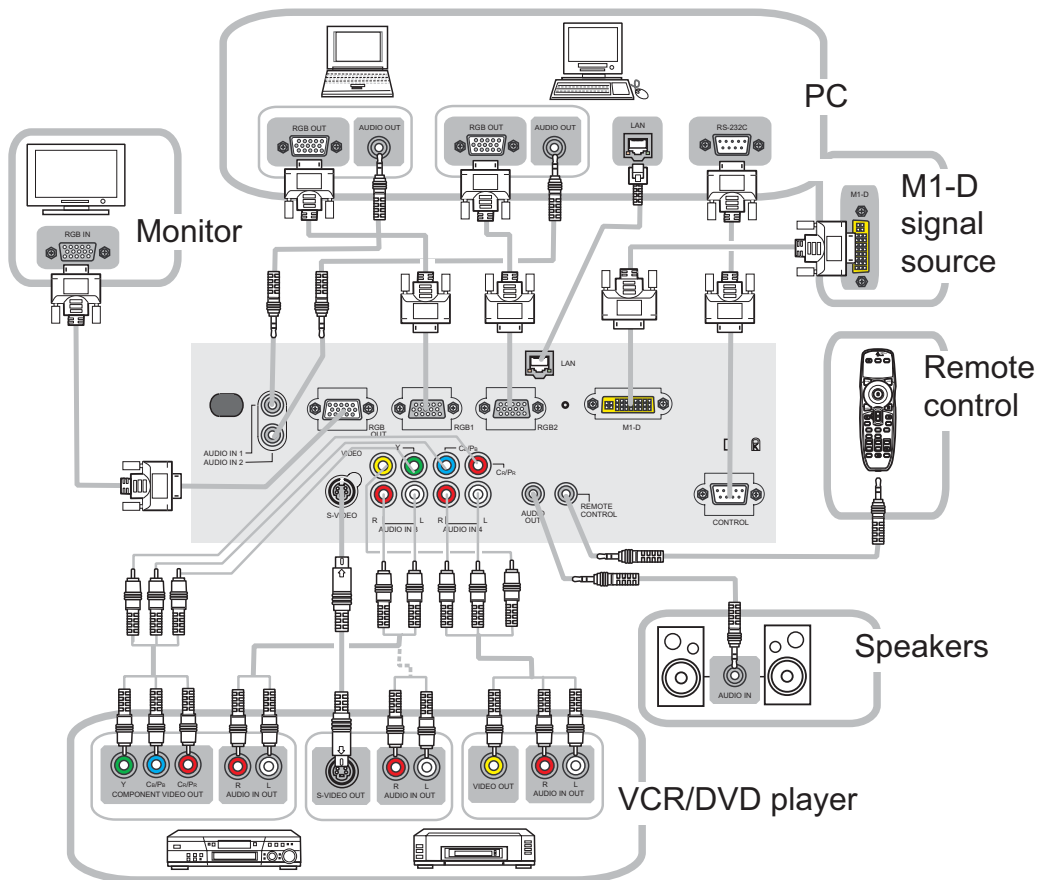

- ⚠ **WARNING** ▶ Do not disassemble or modify the projector.
- ▶ Be careful not to damage the cables, and do not use damaged cables.
- ⚠ **CAUTION** ▶ Turn off all devices and unplug their power cords prior to connecting them to projector. Connecting a live device to the projector may generate extremely loud noises or other abnormalities that may result in malfunction or damage to the device and the projector.
- ▶ Use appropriate accessory or otherwise designed cables. Ask your dealer about non-accessory cables which may have to be of a specific length or equipped with a core. For cables with a core only at one end, connect the end with the core to the projector.
- ▶ Make sure that devices are connected to the correct ports. An incorrect connection may result in malfunction or damage to the device and the projector.

Connecting your devices (continued)

NOTE • Be sure to read the manuals for devices before connecting them to the projector, and make sure that all the devices are suitable to be connected with this product. Before connecting to a PC, check the signal level, the signal timing, and the resolution.

- Do not connect LAN port to any network that might have the excessive voltage.
- Some signal may need an adapter to input this projector.
- Some PCs have multiple screen display modes that may include some signals which are not supported by this projector.
- Although the projector can display signals with resolution up to UXGA (1600X1200), the signal will be converted to the projector's panel resolution before being displayed. The best display performance will be achieved if the resolutions of the input signal and the projector panel are identical.
- While connecting, make sure that the shape of the cable's connector fits the port to connect with. And be sure to tighten the screws on connectors with screws.
- When connecting a laptop PC to the projector, be sure to activate the PC's external RGB output. (Set the laptop PC to CRT display or to simultaneous LCD and CRT display.) For details on how this is done, please refer to the instruction manual of the corresponding laptop PC.
- When the picture resolution is changed on a computer depending on an input, automatic adjustment function may take some time and may not be completed. In this case, you may not be able to see a check box to select "Yes/No" for the new resolution on Windows. Then the resolution will go back to the original. It might be recommended to use other CRT or LCD monitors to change the resolution.
- In some cases, this projector may not display a proper picture or display any picture on screen. For example, automatic adjustment may not function correctly with some input signals. An input signal of composite sync or sync on G may confuse this projector, so the projector may not display a proper picture.
- The M1-D port of this model is compatible with HDCP (High-bandwidth Digital Content Protection) and therefore capable of displaying a video signal from HDCP compatible DVD players or the like.

About Plug-and-Play capability

Plug-and-Play is a system composed of a computer, its operating system and peripheral equipment (i.e. display devices). This projector is VESA DDC 2B compatible. Plug-and-Play can be used by connecting this projector to a computer that is VESA DDC (display data channel) compatible.

- Take advantage of this feature by connecting an RGB cable to the RGB1 port (DDC 2B compatible). Plug-and-Play may not work properly if any other type of connection is attempted.
- Please use the standard drivers in your computer as this projector is a Plug-and-Play monitor.

Connecting power supply

1. Connect the connector of the power cord to the AC inlet of the projector.
2. Firmly plug the power cord's plug into the outlet.

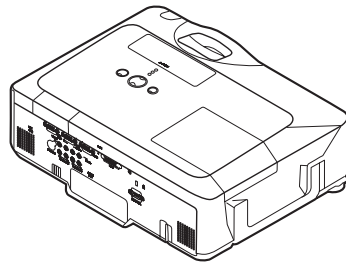

- ⚠ WARNING** ► Please use extra caution when connecting the power cord, as incorrect or faulty connections may result in fire and/or electrical shock.
- Only use the power cord that came with the projector. If it is damaged, contact your dealer to newly get correct one.
 - Only plug the power cord into an outlet rated for use with the power cord's specified voltage range.
 - Never modify the power cord.

Remote control

Laser pointer

This remote control has a laser pointer in place of a finger or rod. The laser beam works and the LASER INDICATOR lights while the LASER button is pressed.

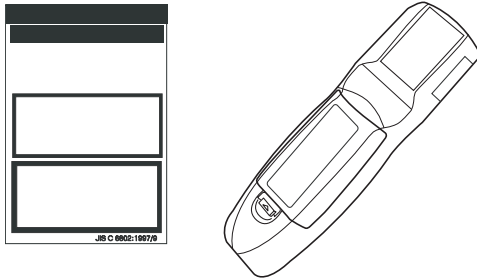

Putting batteries

Please load the batteries before using the remote control. If the remote control starts to malfunction, replace the batteries. If you will not use the remote control for an extended period, remove the batteries from the remote control and store them in a safe place.

1. Slide back and remove the battery cover in the direction of the arrow.
2. Align and insert the two AA batteries according to their plus and minus terminals as indicated in the remote control.
3. Replace the battery cover in the direction of the arrow and snap it back into place.

About the remote control signal

The remote control works with the projector's remote sensors. This projector has three remote sensors on the front, on the top, and on the back.

The sensors can be respectively turned active or inactive using the "REMOTE RECEIV" in the SERVICE item of OPTION menu (□)

Changing the frequency of remote control signal

The accessory remote control has the choice of the mode 1 or the mode 2, in the frequency of its signal. If the remote control does not function properly, attempt to change the signal frequency.

Please remember that the "REMOTE FREQ." in SERVICE item of OPTION menu (📖46) of the projector to be controlled should be set to the same mode as the remote control.

To set the mode of the remote control, slide the knob of the frequency switch inside the battery cover into the position indicated by the mode number to choose.

Using as a wired remote control

The accessory remote control works as a wired remote control, when the wired control port at the bottom of the remote control connects with the REMOTE CONTROL port on the back of the projector via an audio cable with 3.5 diameter stereo mini plugs.

When the remote control signal is hard to reach surely to the projector in the environment, this function is effective.

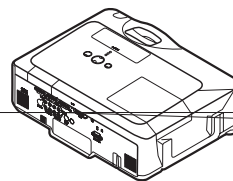

NOTE • To connect the remote control with the projector, use an audio cable with 3.5 diameter stereo mini plugs.

Using as a simple PC mouse & keyboard

The accessory remote control works as a simple mouse and keyboard of the PC, when an M1-D/USB cable connects this projector's M1-D port with the PC's DVI-D and USB (A type) ports.

(1) Mouse left button

Pushing the button into the center point works instead of clicking the mouse's left button.

Tilting this button to one of eight directions moves the PC's move pointer on the screen in the direction.

(2) Mouse right button

Pressing the button works instead of clicking the mouse's right button.

(3) Lever switch

Sliding toward the side marked ▲ works instead of the [↑] key on the keyboard. Sliding toward the side marked ▼ works instead of the [↓] key on the keyboard.

(4) Cursor button ◀

This button works instead of the [←] key on the keyboard.

(5) Cursor button ▶

This button works instead of the [→] key on the keyboard.

(6) PAGE UP button

This button works instead of the PAGE UP key on the key board.

(7) PAGE DOWN button

This button works instead of the PAGE DOWN key on the key board.

NOTE • When the simple mouse & keyboard function of this product does not work correctly, please check the following.

- When an M1-D/USB cable connects this projector with a PC having a built-in pointing device (e.g. track ball) like a notebook PC, open BIOS setup menu, then select the external mouse and disable the built-in pointing device, because the built-in pointing device may have priority to this function.
- Windows 95 OSR 2.1 or higher is required for this function. And also this function may not work depending on the PC's configurations and mouse drivers.
- Operating simultaneously two or more keys is void except for mouse drag and drop operation.
- This function is activated only when the projector is working properly.

Turning on the power

1. Make sure that the power cord is firmly and correctly connected to the projector and the outlet.
2. Remove the lens cover, and set the power switch to the ON position.
The power indicator will light up in steady orange (📖63). Then wait several seconds because the buttons may not function for these several seconds.

(1) When AUTO ON in OPTION menu is set to TURN ON (📖42) :

The lamp will only be automatically turned on when the Power switch is turned on after the power was turned off by Power switch last time. Afterwards the POWER indicator will begin blinking in green. When the power is completely on, the indicator will stop blinking and light in green.

(2) When AUTO ON in the OPTION menu is set to TURN OFF (📖42): Please see step 3.

3. Press the STANDBY/ON button on the projector or the remote control.

To display the picture, select an input signal according to the section "Selecting an input signal" (📖18).

STANDBY/ON
button

POWER
indicator

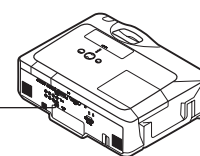

Turning off the power

1. Press the STANDBY/ON button on the projector or the remote control.
The message "Power off?" will appear on the screen for about 5 seconds.
2. Press the STANDBY/ON button on the projector or the remote control again while the message appears.
The projector lamp will go off, and the POWER indicator will begin blinking in orange.
Then the POWER indicator will stop blinking and light in steady orange when the lamp cooling is complete.
3. Make sure that the power indicator lights in steady orange, and set the power switch to the OFF position. The POWER indicator will go off. Attach the lens cover.

Do not turn the projector on for 10 minutes or more after turning it off. Turning the projector on again too soon could shorten the lifetime of some consumable parts of the projector.

Operating

Selecting an input signal (continued)

1. Press the VIDEO button on the remote control to select an input for video signal.

Each time you press the button, the projector switches its video input port as below.

COMPONENT (Y, C_B/R_B, C_R/B_R) → S-VIDEO → VIDEO



- If the VIDEO button is pushed (when switching from RGB to VIDEO signals) when TURN ON is selected for the AUTO SEARCH item in the OPTION menu the projector will check the COMPONENT (Y, C_B/R_B, C_R/B_R) port first. If no input is detected at the port, the projector will check other ports in above order.

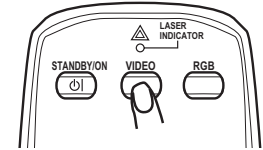

Searching an input signal

1. Press the SEARCH button on the remote control.

The projector will start to check its input ports in order to find any input signals.

When an input is found, the projector will stop searching and display the image. If no signal is found, the projector will return to the state selected before the operation.

RGB 1 → RGB 2 → M1-D → COMPONENT (Y, C_B/R_B, C_R/B_R) → S-VIDEO → VIDEO

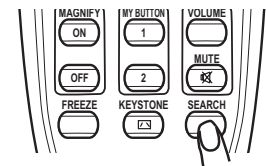

Selecting an aspect ratio

1. Press the ASPECT button on the remote control.

Each time you press the button, the projector switches the mode for aspect ratio in turn.

- For an RGB signal

NORMAL → 4:3 → 16:9 → SMALL



- For an M1-D signal

NORMAL → 4:3 → 16:9 → 14:9 → SMALL

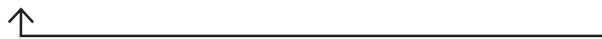

- For a video signal, s-video signal or component video signal

4:3 → 16:9 → 14:9 → SMALL



- For no signal

4:3 (fixed)

- The NORMAL mode keeps the original aspect ratio of the signal.
- Performing the automatic adjustment initializes the aspect ratio setting.

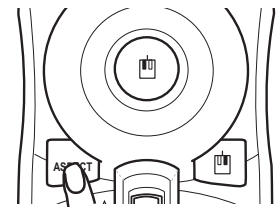

Adjusting the zoom and focus

1. Use the zoom ring to adjust the screen size.
2. Use the focus ring to focus the picture.

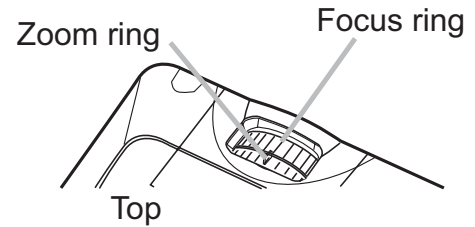

Adjusting the lens shift

1. Use the vertical lens shift dial to shift the picture upward or downward.
2. Use the horizontal lens shift dial to shift the picture left or right.

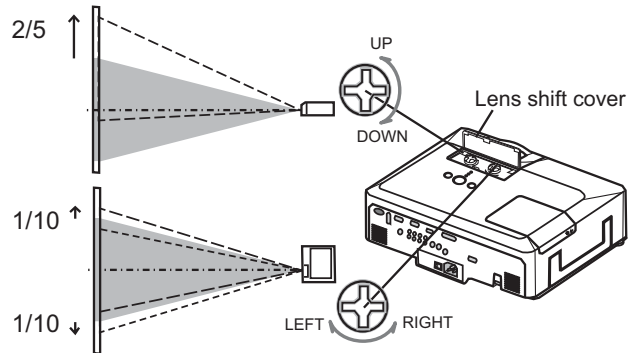

NOTE • When the vertical lens shift is adjusted, it is recommended to shift the picture upward.

Using the automatic adjustment feature

1. Press the AUTO button on the remote control.

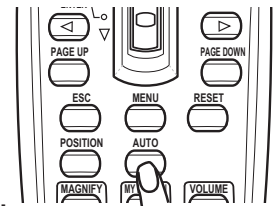

○ For an RGB signal

The vertical position, the horizontal position, the horizontal phase and the horizontal size will be automatically adjusted.

And the aspect ratio will be automatically set to default. Make sure that the application window is set to its maximum size prior to attempting to use this feature. A dark picture may still be incorrectly adjusted. Use a bright picture when adjusting.

○ For an M1-D signal

The aspect ratio will be automatically set to default.

○ For a video signal or s-video signal

The video format best suited for the respective input signal will be selected automatically.

This function is available only when the AUTO is selected to the VIDEO FORMAT item in INPUT menu (32). For a component video signal, the signal type is identified automatically independently of this function.

○ For a video signal, s-video signal or component video signal

The vertical position, horizontal position and aspect ratio will be automatically set to default.

○ For a component video signal

The horizontal phase will be automatically set to default.

- The automatic adjustment operation requires about 10 seconds. Also please note that it may not function correctly with some input.

Adjusting the position

1. Press the POSITION button on the remote control.
 - The “POSITION” indication will appear on the screen.
2. Use the cursor buttons ▲/▼/◀/▶ to adjust the picture position.

When you want to reset the operation, press the RESET button on the remote control during the operation.

To complete this operation, press the POSITION button again. Even if you do not do anything, the dialog will automatically disappear after a few seconds.

- When this function is performed on a video signal, s-video signal or component video signal, some image such as an extra-line may appear at outside of the picture.
- When this function is performed on a video signal, s-video signal, or component video signal of 525i (480i) or 625i (576i), the range of this adjustment depends on the OVER SCAN in IMAGE menu (

Using the magnify feature

1. Press the ON button of MAGNIFY on the remote control.
 - The “MAGNIFY” indication will appear on the screen (although the indication will disappear in several seconds with no operation), and the projector will go into the MAGNIFY mode.

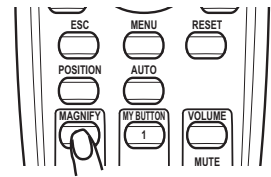

2. Use the cursor buttons ▲/▼ to adjust the zoom level.
 - To move the zoom area, press the POSITION button in the MAGNIFY mode, then use the cursor buttons ▲/▼/◀/▶ to move the area. And to finalize the zoom area, press the POSITION button again.

To exit from the MAGNIFY mode and restore the screen to normal, press the OFF button of MAGNIFY on the remote control.

- The projector automatically exits from the MAGNIFY mode when the input signal is changed, or when the display condition is changed.
- Although in the MAGNIFY mode, the keystone distortion condition may vary, it will be restored when the projector exits from the MAGNIFY mode.

NOTE • The zoom level can be finely adjusted. Closely watch the screen to find the level you want.

Freezing the screen

1. Press the FREEZE button on the remote control.
 - The “FREEZE” indication will appear on the screen (although the indication will not appear when the TURN ON is selected to the MESSAGE item of SCREEN menu (41)), and the projector will go into the FREEZE mode.

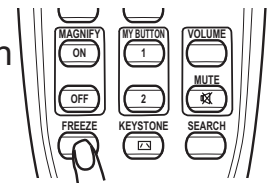

To exit the FREEZE mode and restore the screen to normal, press the FREEZE button again.

- The projector automatically exits from the FREEZE mode when the input signal changes, or when one of the projector’s buttons or the remote control buttons of STANDBY/ON, SEARCH, RGB, VIDEO, BLANK, AUTO, ASPECT, VOLUME, MUTE, KEYSTONE, POSITION, MENU, MAGNIFY and MY BUTTON is pressed.
- If the projector continues projecting a still image for a long time, the LCD panel might possibly be burned in. Do not leave the projector in the FREEZE mode for too long.

Temporarily blanking the screen

- 1 Press the BLANK button on the remote control.
 - The blank screen will be displayed instead of the screen of input signal. Please refer to the BLANK item in SCREEN menu (📖38).

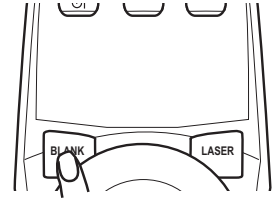

To exit from the blank screen and return to the input signal screen, press the BLANK button again.

- The projector automatically returns to the input signal screen when one of the projector's buttons or the remote control buttons is pressed or one of the commands (except get commands) is transmitted to the control port.

NOTE • The sound is not connected with the blank screen function. If necessary, set the volume or mute first.

Using the menu function

This projector has the following menus: PICTURE, IMAGE, INPUT, SETUP, AUDIO, SCREEN, OPTION, NETWORK, and EASY MENU. EASY MENU consists of functions often used, and the other menus are classified into each purpose. Each of these menus is operated using the same methods. The basic operations of these menus are as follows.

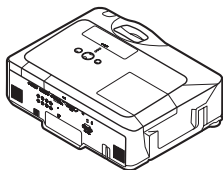

ENTER button

Cursor buttons

MENU button

RESET button

1. Press the MENU button on the remote control or one of the cursor buttons on the projector.
The Advanced MENU, or EASY MENU that has priority just after powered on, will appear.

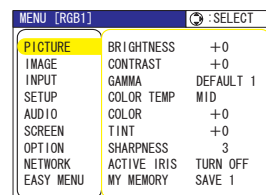

In the EASY MENU

2. If you want to change it to the Advanced MENU, select the "Go to Advanced Menu..."
3. Use the cursor buttons ▲/▼ to select an item to operate.
4. Use the cursor buttons ◀/▶ to operate the item.

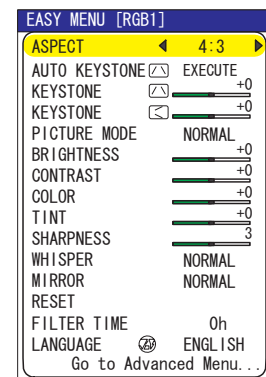

In the Advanced MENU

2. Use the cursor buttons ▲/▼ to select a menu.
If you want to change it to the EASY MENU, select the EASY MENU.
Then press the cursor button ▶ on the projector or remote control, or the ENTER button on the remote control to select an item. The display of the selected menu will be active.
3. Use the cursor buttons ▲/▼ to select an item to operate.
Then press the cursor button ▶ on the projector or remote control, or the ENTER button on the remote control to progress. The operation menu of the selected item will appear.
4. Use the cursor buttons ▲/▼ to operate the item.
 - When you want to reset the operation, press the RESET button on the remote control during the operation. Note that items whose functions are performed simultaneously with operation (ex. LANGUAGE, H PHASE, VOLUME etc.) cannot be reset.
 - In the Advanced MENU, when you want to return to the previous display, press the cursor button ◀ on the projector or remote control, or the ESC button on the remote control.
5. Press the MENU button on the remote control again to close the menu and complete this operation. Even if you do not do anything, the dialog will automatically disappear after about 10 seconds.
 - Some functions cannot be performed when a certain input port is selected, or when a certain input signal is displayed.

EASY Menu (continued)

Item	Description
BRIGHTNESS	Using the ◀/▶ buttons adjusts the brightness. See the BRIGHTNESS item in PICTURE menu (📖26).
CONTRAST	Using the ◀/▶ buttons adjusts the contrast. See the CONTRAST item in PICTURE menu (📖26).
COLOR	Using the ◀/▶ buttons adjusts the strength of whole color. See the COLOR item in PICTURE menu (📖27).
TINT	Using the ◀/▶ buttons adjusts the tint. See the TINT item in PICTURE menu (📖27).
SHARPNESS	Using the ◀/▶ buttons adjusts the sharpness. See the SHARPNESS item in PICTURE menu (📖27).
WHISPER	Using the ◀/▶ buttons turns off/on the whisper mode. See the WHISPER item in SETUP menu (📖36).
MIRROR	Using the ◀/▶ buttons switches the mode for mirror status. See the MIRROR item in SETUP menu (📖36).
RESET	Performing this item resets all of the EASY MENU items except the FILTER TIME and LANGUAGE. A dialog is displayed for confirmation. Selecting the RESET using the ▲ button performs resetting.
FILTER TIME	Performing this item resets the filter time which counts usage time of the air filter. A dialog is displayed for confirmation. Selecting the RESET using the ▲ button performs resetting. See the FILTER TIME item in OPTION menu (📖43).
LANGUAGE	Using the ◀/▶ buttons changes the display language. See the LANGUAGE item in SCREEN menu (📖38).
Go to Advanced Menu...	Select “Go to Advanced Menu...” on the menu, and press the ▶ or ENTER button to use the menu of PICTURE, IMAGE, INPUT, SETUP, AUDIO, SCREEN, OPTION or NETWORK.

PICTURE Menu

From the PICTURE menu, items shown in the table below can be performed.

Select an item using the ▲/▼ cursor buttons on the projector or remote control, and press the ► cursor button on the projector or remote control, or the ENTER button on the remote control to execute the item. Then perform it according to the following table.

Item	Description
BRIGHTNESS	Using the ▲/▼ buttons adjusts the brightness. Light ⇔ Dark
CONTRAST	Using the ▲/▼ buttons adjusts the contrast. Strong ⇔ Weak
GAMMA	<p>Using the ▲/▼ buttons switches the gamma mode.</p> <p style="text-align: center;">#1 DEFAULT ⇔ #1 CUSTOM ⇔ #2 DEFAULT ⇔ #2 CUSTOM ⇔ #3 DEFAULT ↑ ↓ ↑ ↓</p> <p style="text-align: center;">#5 CUSTOM ⇔ #5 DEFAULT ⇔ #4 CUSTOM ⇔ #4 DEFAULT ⇔ #3 CUSTOM</p> <p style="text-align: center;">To adjust CUSTOM</p> <p>Selecting a mode whose name includes CUSTOM and then pressing the ► button or the ENTER button displays a dialog to aid you in adjusting the mode. This function is useful when you want to change the brightness of particular tones.</p>  <p>Choose an item using the ◀/▶ buttons, and adjust the level using the ▲/▼ buttons.</p> <p>You can display a test pattern for checking the effect of your adjustment by pressing the ENTER button. Each time you press the ENTER button, the pattern changes as below.</p> <p>No pattern ⇔ Gray scale of 9 steps ⇨ ↑ ↓ Ramp ⇔ Gray scale of 15 steps</p> <p>The eight equalizing bars correspond to eight tone levels of the test pattern except the darkest in the left end. If you want to adjust the 2nd tone from left end on the test pattern (Gray scale of 9 steps), use the equalizing adjustment bar “1”. The darkest tone at the left end of the test pattern cannot be controlled with any of equalizing adjustment bar.</p> <ul style="list-style-type: none"> • When this function is performed, lines or other distortion may appear.

PICTURE Menu (continued)

Item	Description
<p>COLOR TEMP</p>	<p>Using the ▲/▼ buttons switches the color temperature mode.</p> <p>→ HIGH DEFAULT ⇔ HIGH CUSTOM ⇔ MID DEFAULT ⇔ MID CUSTOM ← ↳ LOW DEFAULT ⇔ LOW CUSTOM ⇔ HI-BRIGHT-1 DEFAULT ⇔ HI-BRIGHT-1 CUSTOM ← ↳ HI-BRIGHT-2 DEFAULT ⇔ HI-BRIGHT-2 CUSTOM ←</p> <p>To adjust CUSTOM</p> <p>Selecting a mode whose name includes CUSTOM and then pressing the ► button or the ENTER button displays a dialog to aid you in adjusting the OFFSET and GAIN of the selected mode.</p> <p>OFFSET adjustments change the color intensity on the whole tones of the test pattern.</p> <p>GAIN adjustments mainly affect color intensity on the brighter tones of the test pattern.</p> <p>Choose an item using the ◀/▶ buttons, and adjust the level using the ▲/▼ buttons.</p> <p>You can display a test pattern for checking the effect of your adjustment by pressing the ENTER button. Each time you press the ENTER button, the pattern changes as below.</p> <p>No pattern ⇔ Gray scale of 9 steps ⇔ Ramp ⇔ Gray scale of 15 steps</p> <ul style="list-style-type: none"> • When this function is performed, lines or other distortion may appear.
<p>COLOR</p>	<p>Using the ▲/▼ buttons adjusts the strength of whole color.</p> <p>Strong ⇔ Weak</p> <ul style="list-style-type: none"> • This item can be selected only for a video signal, s-video or component video signal.
<p>TINT</p>	<p>Using the ▲/▼ buttons adjusts the tint.</p> <p>Greenish ⇔ Reddish</p> <ul style="list-style-type: none"> • This item can be selected only for a video signal, s-video or component video signal.
<p>SHARPNESS</p>	<p>Using the ▲/▼ buttons adjusts the sharpness.</p> <p>Strong ⇔ Weak</p> <ul style="list-style-type: none"> • There may be some noise and/or the screen may flicker for a moment when an adjustment is made. This is not a malfunction.

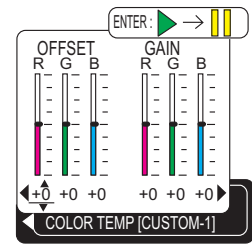

(continued on next page)

PICTURE Menu

PICTURE Menu (continued)

Item	Description								
<p>ACTIVE IRIS</p>	<p>Using the ▲/▼ cursor buttons changes the active iris control mode. PRESENTATION ⇔ THEATER ⇔ TURN OFF</p>  <table border="1" data-bbox="492 447 1414 663"> <thead> <tr> <th></th> <th>Feature</th> </tr> </thead> <tbody> <tr> <td>PRESENTATION</td> <td>The active iris displays the best presentation image for both bright and dark scenes.</td> </tr> <tr> <td>THEATER</td> <td>The active iris displays the best theater image for both bright and dark scenes.</td> </tr> <tr> <td>TURN OFF</td> <td>The active iris is always open.</td> </tr> </tbody> </table> <ul style="list-style-type: none"> • The screen may flicker when the PRESENTATION or THEATER modes are selected. If this occurs select TURN OFF. 		Feature	PRESENTATION	The active iris displays the best presentation image for both bright and dark scenes.	THEATER	The active iris displays the best theater image for both bright and dark scenes.	TURN OFF	The active iris is always open.
	Feature								
PRESENTATION	The active iris displays the best presentation image for both bright and dark scenes.								
THEATER	The active iris displays the best theater image for both bright and dark scenes.								
TURN OFF	The active iris is always open.								
<p>MY MEMORY</p>	<p>This projector has 4 memories for adjustment data (for all the items of the PICTURE menu). Selecting a function using the ▲/▼ buttons and pressing the ► or ENTER button performs each function.</p>  <p><u>LOAD1, LOAD2, LOAD3, LOAD4</u></p> <p>Performing a LOAD function loads the data from the memory linked in the number included in the function's name, and adjusts the picture automatically depending on the data.</p> <ul style="list-style-type: none"> • The LOAD functions whose linked memory has no data are skipped. • Remember that the current adjusted condition will be lost by loading data. If you want to keep the current adjustment, please save it before performing a LOAD function. • There may be some noise and the screen may flicker for a moment when loading data. This is not malfunction. • The LOAD functions can be also performed by the MY MEMORY button which can be set by the MY BUTTON item in OPTION menu (44). <p><u>SAVE1, SAVE2, SAVE3, SAVE4</u></p> <p>Performing a SAVE function saves the current adjustment data into the memory linked in the number included in the function's name.</p> <ul style="list-style-type: none"> • Remember that the current data being stored of a memory will be lost by saving a new data into the memory. 								

IMAGE Menu

From the IMAGE menu, items shown in the table below can be performed.

Select an item using the ▲/▼ cursor buttons on the projector or remote control, and press the ► cursor button on the projector or remote control, or ENTER button on the remote control to execute the item. Then perform it according to the following table.

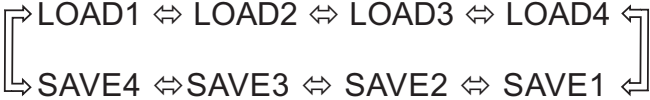
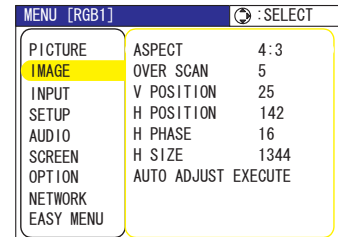

Item	Description
<p>ASPECT</p>	<p>Using the ▲/▼ buttons switches the mode for aspect ratio.</p> <p>For an RGB signal NORMAL ⇔ 4:3 ⇔ 16:9 ⇔ SMALL ↑—————↑</p> <p>For an M1-D signal NORMAL ⇔ 4:3 ⇔ 16:9 ⇔ 14:9 ⇔ SMALL ↑—————↑</p> <p>For a Video signal, S-video signal or Component video signal 4:3 ⇔ 16:9 ⇔ 14:9 ⇔ SMALL ↑—————↑</p> <p>For no signal 4:3 (fixed)</p> <ul style="list-style-type: none"> • The NORMAL mode keeps the original aspect ratio of the signal.
<p>OVER SCAN</p>	<p>Using the ▲/▼ buttons adjusts the over-scan ratio. Large (It reduces picture) ⇔ Small (It magnifies picture)</p> <ul style="list-style-type: none"> • This item can be selected only for a video, s-video and component signal. • When this adjustment is too large, certain degradation may appear at the frame area of the picture. In such a case, please adjust small.
<p>V POSITION</p>	<p>Using the ▲/▼ buttons adjusts the vertical position. Up ⇔ Down</p> <ul style="list-style-type: none"> • Over-adjusting the vertical position may cause noise to appear on the screen. If this occurs please reset the vertical position to the default setting. Pressing the RESET button when the V POSITION is selected will reset the V POSITION to the default setting. • When this function is performed on a video signal, s-video signal, or component video signal of 525i (480i) or 625i (576i), the range of this adjustment depends on the OVER SCAN (above) setting. It is not possible to adjust when the OVER SCAN is set to 10.
<p>H POSITION</p>	<p>Using the ▲/▼ buttons adjusts the horizontal position. Left ⇔ Right</p> <ul style="list-style-type: none"> • Over-adjusting the horizontal position may cause noise to appear on the screen. If this occurs please reset the horizontal position to the default setting. Pressing the RESET button when the H POSITION is selected will reset the H POSITION to the default setting. • When this function is performed on a video signal, s-video signal, or component video signal of 525i (480i) or 625i (576i), the range of this adjustment depends on the OVER SCAN (above) setting. It is not possible to adjust when the OVER SCAN is set to 10.

IMAGE Menu

IMAGE Menu (continued)

Item	Description
H PHASE	<p>Using the ▲/▼ buttons adjusts the horizontal phase to eliminate flicker. Right ⇔ Left</p> <ul style="list-style-type: none"> • This item can be selected only for an RGB signal or a component video signal. (except 525i (480i), 625i (576i), SCART RGB)
H SIZE	<p>Using the ▲/▼ buttons adjusts the horizontal size. Large ⇔ Small</p> <ul style="list-style-type: none"> • This item can be selected only for an RGB signal. • When this adjustment is excessive, the picture may not be displayed correctly. In such a case, please reset the adjustment by pressing the RESET button on the remote control during this operation.
AUTO ADJUST EXECUTE	<p>Selecting this item performs the automatic adjustment feature.</p> <p>For an RGB signal The vertical position, the horizontal position, the horizontal phase and the horizontal size will be automatically set to default. And the aspect ratio will be automatically selected. Make sure that the application window is set to its maximum size prior to attempting to use this feature. A dark picture may still be incorrectly adjusted. Use a bright picture when adjusting.</p> <p>For an M1-D signal The aspect ratio will be automatically set to default.</p> <p>For a Video signal or S-video signal The video format best suited for the respective input signal will be selected automatically. This function is available only when the AUTO mode is selected to the VIDEO FORMAT item in INPUT menu. For a component video signal, the signal type is identified automatically independently of this function.</p> <p>For a Video signal, S-video signal or Component video signal The vertical position, horizontal position and aspect ratio will be automatically set to default.</p> <p>For a Component video signal The horizontal phase will be automatically set to default.</p> <ul style="list-style-type: none"> • The automatic adjustment operation requires about 10 seconds. Also please note that it may not function correctly with some input.

INPUT Menu

From the INPUT menu, items shown in the table below can be performed.

Select an item using the ▲/▼ cursor buttons on the projector or remote control, and press the ► cursor button on the projector or remote control, or ENTER button on the remote control to execute the item. Then perform it according to the following table.

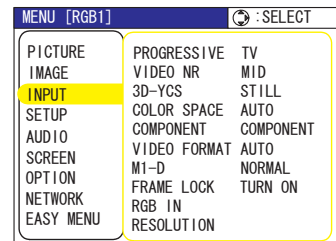

Item	Description
PROGRESSIVE	Using the ▲/▼ buttons switches the progress mode. TV ⇔ FILM ⇔ TURN OFF <ul style="list-style-type: none"> This function is performed only for an interlaced signal of a VIDEO input, an S-VIDEO input or COMPONENT VIDEO input of 525i (480i), 625i (576i) or 1125i (1080i) signal. When TV or FILM is selected, the screen image will be sharp. FILM adapts to the 2-3 Pull-Down conversion system. But these may cause a certain defect (for example, jagged line) of the picture for a quick moving object. In such a case, please select TURN OFF, even though the screen image may lose the sharpness.
VIDEO NR	Using the ▲/▼ buttons switches the noise reduction mode. HIGH ⇔ MID ⇔ LOW <ul style="list-style-type: none"> This function performs only at a VIDEO input, an S-VIDEO or COMPONENT VIDEO input of 525i(480i), 625i(576i) or 1125i (1080i) signal. When this function is excessive, it may cause a certain degradation of the picture.
3D-YCS	Using the ▲/▼ buttons switches the 3D-YCS mode. STILL ⇔ MOVIE ⇔ TURN OFF <ul style="list-style-type: none"> This function performs only at a VIDEO input of NTSC, and PAL. MOVIE is the mode for images with a lot of motions like movies, and STILL is the mode for images with few motions or completely still ones like slides.
COLOR SPACE	Using the ▲/▼ buttons switches the mode for color space. AUTO ⇔ RGB ⇔ SMPTE240 ⇔ REC709 ⇔ REC601 <ul style="list-style-type: none"> This item can be selected only for an RGB signal or a component video signal (except 525i (480i), 625i (576i) and SCART RGB). The AUTO mode automatically selects the optimum mode. The AUTO operation may not work well at some signals. In such a case, it might be good to select a suitable mode except AUTO.

(continued on next page)

INPUT Menu

INPUT Menu (continued)

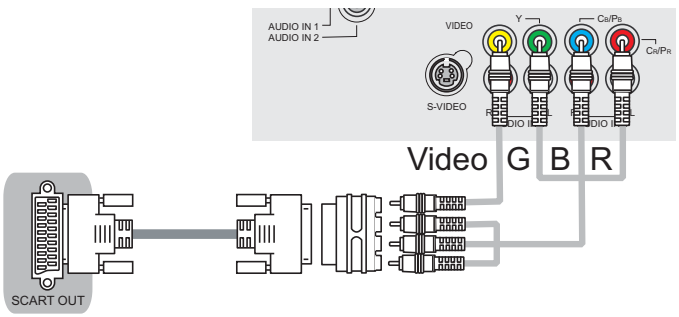
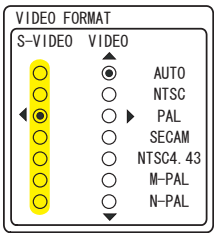
Item	Description						
<p>COMPONENT</p>	<p>Using the ▲/▼ buttons switches the function of the COMPONENT (Y, C_B/P_B, C_R/P_R) port. COMPONENT ⇔ SCART RGB</p> <p>When the SCART RGB is selected, the COMPONENT (Y, C_B/P_B, C_R/P_R) and VIDEO ports will function as a SCART RGB port. A SCART adapter or SCART cable is required for a SCART RGB input to the projector. For details, contact your dealer.</p> 						
<p>VIDEO FORMAT</p>	<p>Set the video format for the s-video port and video port. (1) Use the ◀/▶ buttons to select the input port. (2) Using the ▲/▼ buttons switches the mode for video format.</p> <p>AUTO ⇔ NTSC ⇔ PAL ⇔ SECAM ↕ N-PAL ⇔ M-PAL ⇔ NTSC4.43 ↕</p> <ul style="list-style-type: none"> • This item is performed only for a video signal from the VIDEO port or the S-VIDEO port. • The AUTO mode automatically selects the optimum mode. • The AUTO operation may not work well for some signals. If the picture becomes unstable (e.g. an irregular picture, lack of color), please select the mode according to the input signal. 						
<p>M1-D</p>	<p>Using the ▲/▼ cursor buttons changes the M1-D signal mode. NORMAL ⇔ ENHANCED</p> <table border="1" data-bbox="487 1480 1412 1606"> <thead> <tr> <th></th> <th>Feature</th> </tr> </thead> <tbody> <tr> <td>NORMAL</td> <td>Suitable for DVD signals (16-235)</td> </tr> <tr> <td>ENHANCED</td> <td>Suitable for VGA signals (0-255)</td> </tr> </tbody> </table> <ul style="list-style-type: none"> • If the contrast of the screen image is too strong or too weak, try finding a more suitable mode. 		Feature	NORMAL	Suitable for DVD signals (16-235)	ENHANCED	Suitable for VGA signals (0-255)
	Feature						
NORMAL	Suitable for DVD signals (16-235)						
ENHANCED	Suitable for VGA signals (0-255)						

(continued on next page)



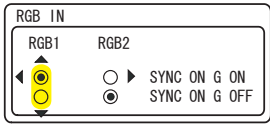

INPUT Menu (continued)

Item	Description
FRAME LOCK	<p>Using the ▲/▼ buttons turns the frame lock function on/off. TURN ON ⇔ TURN OFF</p> <ul style="list-style-type: none"> • This item can be performed only on an RGB signal with a vertical frequency of 50 to 60 Hz. • When the TURN ON is selected, a moving pictures are displayed more smoothly. • This function may cause a certain degradation of the picture. In such a case, please select the TURN OFF.
RGB IN	<p>Set the RGB input signal type for the RGB port.</p> <p>(1) Use the ◀/▶ buttons to select the RGB port to be set. RGB1 ⇔ RGB2</p> <p>(2) Use the ▲/▼ buttons to select the RGB input signal type. SYNC ON G ON ⇔ SYNC ON G OFF</p> <ul style="list-style-type: none"> • Selecting the SYNC ON G ON turns the SYNC ON G mode on. The SYNC ON G mode allows reception of a sync on G signal. • In the SYNC ON G mode, the picture may be distorted with certain input signals. In such a case, remove the signal connector so that no signal is received and turn the SYNC ON G mode off, and then reconnect the signal. 

(continued on next page)

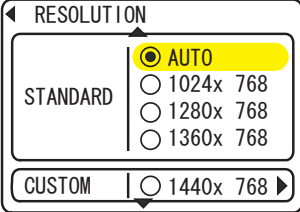
INPUT Menu

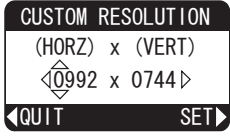
INPUT Menu (continued)

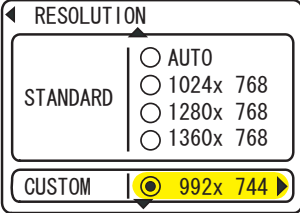

Item	Description
<p>RESOLUTION</p>	<p>The resolution for the RGB1 and RGB2 input signals can be set on this projector.</p> <p>(1) In the INPUT menu select the RESOLUTION using the ▲/▼ buttons and press the ► button. The RESOLUTION menu will be displayed.</p>  <p style="text-align: center;">RESOLUTION MENU</p>  <p>(2) In the RESOLUTION menu select the resolution you wish to display using the ▲/▼ buttons. Selecting AUTO will set a resolution appropriate to the input signal.</p> <p>(3) Pressing the ► or ENTER button when selecting a STANDARD resolution will automatically adjust the horizontal and vertical positions, clock phase and horizontal size and automatically select an aspect ratio. The INFORMATION dialog (46) will be displayed.</p> <p>(4) To set a custom resolution use the ▲/▼ buttons to select the CUSTOM and the CUSTOM RESOLUTION BOX will be displayed. Set the horizontal (HORZ) and vertical (VERT) resolutions using the ▲/▼/◀/▶ buttons. Although not all resolutions are guaranteed.</p>  <p style="text-align: center;">CUSTOM RESOLUTION BOX</p>  <p>(5) To save the setting place the cursor on the right-most digit and press the ► button. The horizontal and vertical positions, clock phase and horizontal size will be automatically adjusted and an aspect ratio will be automatically selected. After the INFORMATION(46) dialog has displayed for about 10 seconds the screen will return to the RESOLUTION menu displaying the changed resolution.</p>  <p>(6) To revert back to the previous resolution without saving changes place the cursor on the left-most digit and press the ◀ button. The screen will then return to the RESOLUTION menu displaying the previous resolution.</p> <ul style="list-style-type: none"> • For some pictures, this function may not work well.

SETUP Menu

From the SETUP menu, items shown in the table below can be performed.

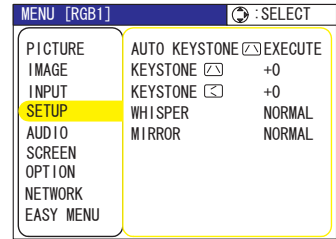
Select an item using the ▲/▼ cursor buttons on the projector or remote control, and press the ► cursor button on the projector or remote control, or the ENTER button on the remote control to execute the item. Then perform it according to the following table.







Item	Description
<p>AUTO KEYSTONE EXECUTE </p>	<p>Selecting this item performs the Automatic keystone distortion correction. Projector automatically corrects vertical keystone distortion due to the (forward/backward) setup angle by itself.</p> <p>This function will be executed only once when selected in the Menu. When the slant of the projector is changed, execute this function again.</p> <ul style="list-style-type: none"> • The adjustable range of this function will vary among inputs. For some input, this function may not work well. • When V:INVERT or H&V:INVERT is selected to the MIRROR item in the SETUP menu, if the projector screen is inclined or angled downward, this function may not work correctly. • When the zoom adjustment is set to the TELE (telephoto focus), this function may be excessive. This function should be used when the zoom adjustment is set to the full WIDE (wide-angle focus) whenever possible. • When the projector is placed on the level (about ±3°), this function may not work. • When the projector is inclined to near ±30 degree or over, this function may not work well. • When the vertical lens shift is not set fully upward (not set fully downward for the optional lens type FL-601 only (45)), this function may not work well. • When the horizontal lens shift is not set to the center, this function may not work well. • This function will be unavailable when the Transition Detector is on (51).
<p>KEYSTONE </p>	<p>Using the ▲/▼ buttons corrects the vertical keystone distortion.</p> <p>Shrink the top of the image ↔ Shrink the bottom of the image</p> <ul style="list-style-type: none"> • The adjustable range of this function will vary among inputs. For some input, this function may not work well. • When the vertical lens shift is not set fully upward (not set fully downward for the optional lens type FL-601 only (45)), this function may not work well. • When the horizontal lens shift is not set to the center, this function may not work well. • This function will be unavailable when the Transition Detector is on (51).
<p>KEYSTONE </p>	<p>Using the ▲/▼ buttons corrects the horizontal keystone distortion.</p> <p>Shrink the right of the image ↔ Shrink the left of the image</p> <ul style="list-style-type: none"> • The adjustable range of this function will vary among inputs. For some input, this function may not work well. • When the horizontal lens shift is not set to the center, this function may not work well. • This function will be unavailable when the Transition Detector is on (51).

(continued on next page)

SETUP Menu

SETUP Menu (continued)

Item	Description
<p>WHISPER</p>	<p>Using the ▲/▼ buttons turns off/on the whisper mode. NORMAL ⇔ WHISPER</p> <ul style="list-style-type: none"> • When the WHISPER is selected, acoustic noise and screen brightness are reduced.
<p>MIRROR</p>	<p>Using the ▲/▼ buttons switches the mode for mirror status.</p> <div style="display: flex; justify-content: space-around; align-items: center;">     </div> <p>NORMAL ⇔ H:INVERT ⇔ V:INVERT ⇔ H&V:INVERT</p> <p style="text-align: center;">↑—————↑</p> <p>If the Transition Detector is TURN ON and MIRROR status is changed, Transition Detector Alarm (📖51) will be displayed when projector is restarted after the power switch is turned off.</p>



AUDIO Menu

From the AUDIO menu, items shown in the table below can be performed.

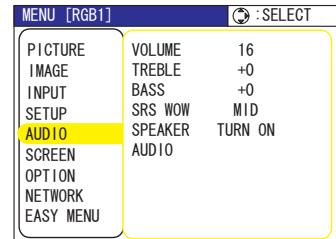
Select an item using the ▲/▼ cursor buttons on the projector or remote control, and press the ► cursor button on the projector or remote control, or ENTER button on the remote control to execute the item. Then perform it according to the following table.

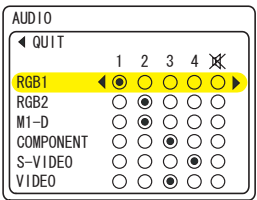

NOTE • The speaker sound may distorted or the case may be trembling when the volume is too high or treble/bass is emphasized or WOW is activated. In that case, make the volume reduced, bass/treble low or WOW effect to be weakend.

Item	Description
VOLUME	Using the ▲/▼ buttons adjusts the volume. High ⇄ Low
TREBLE	Using the ▲/▼ buttons adjusts the treble level. High ⇄ Low
BASS	Using the ▲/▼ buttons adjusts the bass level. High ⇄ Low
SRS WOW 	Using the ▲/▼ buttons switches the mode for SRS WOW mode. HIGH ⇄ MID ⇄ OFF • SRS WOW™ accomplishes this by providing a panoramic three-dimensional audio image that extends the sound field in both the horizontal and vertical planes, and lowers the perceived bass response well beyond the low frequency limitations of the drivers. Adjust it depending on the user's preference.
SPEAKER	Using the ▲/▼ buttons turns the speaker function on/off. TURN ON ⇄ TURN OFF • When the TURN ON is selected the built-in speaker works.
AUDIO	Allocates the audio ports. (1) Choose a picture input port using the ▲/▼ buttons. <div style="text-align: center;">  <p>RGB1 ⇄ RGB2 ⇄ M1-D ⇄ VIDEO ⇄ S-VIDEO ⇄ COMPONENT</p> </div> (2) Select the audio port to be interlocked with the input port using the ◀/▶ buttons. 1 ⇄ 2 ⇄ 3 ⇄ 4 ⇄ ✕ When ✕ is selected to an input port, any audio ports do not work interlocking with the input port, and any items in AUDIO menu are invalid. <div style="text-align: right;">  </div>

SCREEN Menu

SCREEN Menu

From the SCREEN menu, items shown in the table below can be performed.

Select an item using the ▲/▼ cursor buttons on the projector or remote control, and press the ► cursor button on the projector or remote control, or ENTER button on the remote control to execute the item. Then perform it according to the following table.

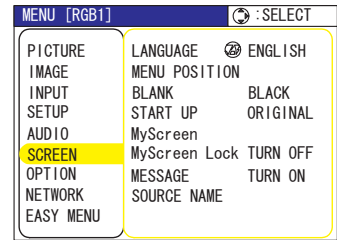

Item	Description								
LANGUAGE	<p>Using the ▲/▼ buttons switches the OSD (On Screen Display) language. ENGLISH ⇔ FRANÇAIS ⇔ DEUTSCH ⇔ ESPAÑOL ⇔ ITALIANO NORSK ⇔ NEDERLANDS ⇔ PORTUGUÊS ⇔ 日本語 简体中文 ⇔ 繁體中文 ⇔ 한글 ⇔ SVENSKA ⇔ РУССКИЙ SUOMI ⇔ POLSKI ⇔ TÜRKÇE</p>								
MENU POSITION	<p>Using the ◀/▶/▲/▼ buttons adjusts the menu position. To quit the operation, press the MENU button on the remote control or keep no operation for about 10 seconds.</p>								
BLANK	<p>Using the ▲/▼ buttons switches the mode for the blank screen. The blank screen is a screen for the temporarily blanking feature (📖22). It is displayed by pressing the BLANK button on the remote control. MyScreen ⇔ ORIGINAL ⇔ BLUE ⇔ WHITE ⇔ BLACK</p> <table border="1"> <thead> <tr> <th></th> <th>Feature</th> </tr> </thead> <tbody> <tr> <td>MyScreen</td> <td>Screen can be registered by the MyScreen item (📖40).</td> </tr> <tr> <td>ORIGINAL</td> <td>Screen preset as the standard screen.</td> </tr> <tr> <td>BLUE, WHITE, BLACK</td> <td>Plain screens in each color.</td> </tr> </tbody> </table> <p>• To avoid remaining as an afterimage, the MyScreen or ORIGINAL screen will change to the plain black screen after several minutes.</p>		Feature	MyScreen	Screen can be registered by the MyScreen item (📖40).	ORIGINAL	Screen preset as the standard screen.	BLUE, WHITE, BLACK	Plain screens in each color.
	Feature								
MyScreen	Screen can be registered by the MyScreen item (📖40).								
ORIGINAL	Screen preset as the standard screen.								
BLUE, WHITE, BLACK	Plain screens in each color.								

(continued on next page)

SCREEN Menu (continued)

Item	Description								
<p>START UP</p>	<p>Using the ▲/▼ buttons switches the mode for the start-up screen. The start-up screen is a screen displayed when no signal or an unsuitable signal is detected.</p> <p style="text-align: center;">MyScreen ⇔ ORIGINAL ⇔ TURN OFF</p> <div style="text-align: center;"> </div> <table border="1" data-bbox="492 489 1414 678" style="width: 100%; border-collapse: collapse;"> <thead> <tr> <th style="width: 50%;"></th> <th style="width: 50%;">Feature</th> </tr> </thead> <tbody> <tr> <td>MyScreen</td> <td>Screen can be registered by the MyScreen item (📖40).</td> </tr> <tr> <td>ORIGINAL</td> <td>Screen preset as the standard screen.</td> </tr> <tr> <td>TURN OFF</td> <td>Plain black screen.</td> </tr> </tbody> </table> <ul style="list-style-type: none"> • To avoid remaining as an afterimage, the MyScreen or ORIGINAL screen will change to the BLANK screen (📖38) after several minutes. If also the BLANK screen is the MyScreen or ORIGINAL, the plain black screen is instead used. • When the TURN ON is selected to the MyScreen PASSWORD of SECURITY item in OPTION menu (📖48), the START UP is fixed to MyScreen. 		Feature	MyScreen	Screen can be registered by the MyScreen item (📖40).	ORIGINAL	Screen preset as the standard screen.	TURN OFF	Plain black screen.
	Feature								
MyScreen	Screen can be registered by the MyScreen item (📖40).								
ORIGINAL	Screen preset as the standard screen.								
TURN OFF	Plain black screen.								

(continued on next page)



SCREEN Menu

SCREEN Menu (continued)

Item	Description
<p>MyScreen</p>	<p>This item allows you to capture an image for use as a MyScreen image which can be used as the BLANK screen and START UP screen. Display the image you want to capture before executing the following procedure.</p> <ol style="list-style-type: none"> 1. Selecting this item displays a dialog titled “MyScreen”. It will ask you if you start capturing an image from the current screen. <div data-bbox="1182 457 1425 533" data-label="Image"> </div> <p>Please wait for the target image to be displayed, and press the ENTER button on the remote control when the image is displayed. The image will freeze and the frame for capturing will appear.</p> <p>To stop performing, press the RESET or ESC button on the remote control.</p> 2. Using the ▲/▼/◀/▶ buttons adjusts the frame position. <div data-bbox="1138 793 1425 974" data-label="Image"> </div> <p>Please move the frame to the position of the image which you want to use. The frame may not be able to be moved for some input signals.</p> <p>To start registration, press the ENTER button on the remote control.</p> <p>To restore the screen and return to the previous dialog, press the RESET or ESC button on the remote control.</p> <p>Registration takes several minutes.</p> <p>When the registration is completed, the registered screen and the following message are displayed for several seconds:</p> <p>“MyScreen registration is finished.”</p> <p>If the registration failed, the following message is displayed:</p> <p>“A capturing error has occurred. Please try again.”</p> <ul style="list-style-type: none"> • This item cannot be selected for an M1-D signal. • This function cannot be selected when the TURN ON is selected to the MyScreen Lock item (📖below). • This function cannot be selected when the TURN ON is selected to the MyScreen PASSWORD of SECURITY item in OPTION menu (📖48).
<p>MyScreen Lock</p>	<p>Using the ▲/▼ buttons turns on/off the MyScreen lock function.</p> <p>TURN ON ⇔ TURN OFF</p> <p>When the TURN ON is selected, the item MyScreen is locked. Use this function for protecting the current MyScreen.</p> <ul style="list-style-type: none"> • This function cannot be selected when the TURN ON is selected to the MyScreen PASSWORD of SECURITY item in OPTION menu (📖48).

(continued on next page)

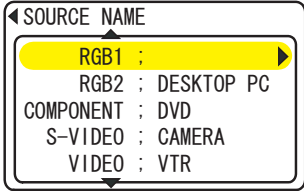
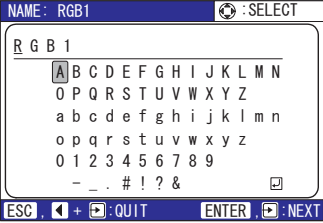
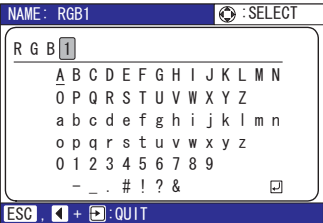
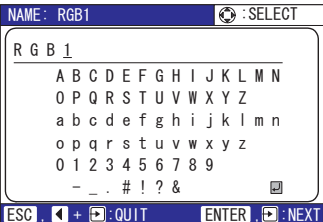
SCREEN Menu (continued)

Item	Description
<p>MESSAGE</p>	<p>Using the ▲/▼ buttons turns on/off the message function. TURN ON ⇔ TURN OFF</p> <p>When the TURN ON is selected, the following message function works. “AUTO IN PROGRESS” while automatically adjusting “NO INPUT IS DETECTED” “SYNC IS OUT OF RANGE” “Searching...” while searching for the input “Detecting...” while an input signal is detected The indication of the input signal displayed by changing The indication of the aspect ratio displayed by changing The indication of the PICTURE MODE displayed by changing The indication of the ACTIVE IRIS displayed by changing The indication of the MY MEMORY displayed by changing The indication of "FREEZE" and "II" while freezing the screen by pressing the FREEZE button.</p> <ul style="list-style-type: none"> • When the TURN OFF is selected, please remember if the picture is freezing. Do not mistake freezing for a malfunction (📖21).
<p>SOURCE NAME</p>	<p>Each input port for this projector can have a name applied to it.</p> <p>(1) Use the ▲/▼ buttons on the SCREEN menu to select SOURCE NAME and press the ► button. The SOURCE NAME menu will be displayed.</p>  <p>(2) Use the ▲/▼ buttons on the SOURCE NAME menu to select the port to be named and press the ► button. Right side of the menu is blank until a name is specified. The SOURCE NAME dialog will be displayed.</p>  <p>(3) The current name will be displayed on the first line. Use the ▲/▼/◀/▶ buttons and the ENTER or INPUT button to select and enter characters. The RESET button can be used to erase 1 character at a time. The name can be a maximum of 16 characters.</p>  <p>(4) To change an already inserted character, press the ▲ button while the cursor is on the [A-N] row to move the cursor to the name displayed on the first line and use the ◀/▶ buttons to select character to be changed. Once a character in the name is selected use the ▼ button to move the cursor back down to the character entry area to select and enter characters as described above.</p>  <p>(5) Select  and press the ENTER or INPUT buttons when finished entering text. To revert to the previous name without saving changes press the ESC or ◀ button and the INPUT button simultaneously.</p>

OPTION Menu

OPTION Menu

From the OPTION menu, items shown in the table below can be performed.

Select an item using the ▲/▼ cursor buttons on the projector or remote control, and press the ► cursor button on the projector or remote control, or ENTER button on the remote control to execute the item, except for the items LAMP TIME and FILTER TIME. Then perform it according to the following table.

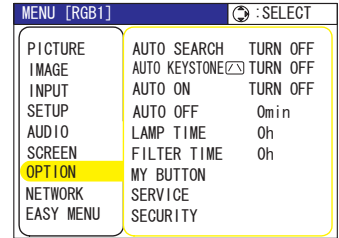

Item	Description
AUTO SEARCH	<p>Using the ▲/▼ buttons turns on/off the automatic signal search function. TURN ON ⇔ TURN OFF</p> <p>When the TURN ON is selected, detecting no signal automatically cycles through input ports in the following order. The search is started from the current port. Then when an input is found, the projector will stop searching and display the image.</p> <p>RGB 1 ⇨ RGB 2 ⇨ M1-D ⇨ COMPONENT ⇨ S-VIDEO ⇨ VIDEO</p>
AUTO KEYSTONE [/ \]	<p>Using the ▲/▼ buttons turns on/off the automatic keystone function. TURN ON ⇔ TURN OFF</p> <p>TURN ON : Automatic keystone distortion correction will be executed whenever changing the slant of the projector.</p> <p>TURN OFF : This function is disabled. Please execute the AUTO KEYSTONE [/ \] EXECUTE in the SETUP Menu for automatic keystone distortion correction.</p> <ul style="list-style-type: none"> • When the projector is suspended from the ceiling this feature will not function properly so select the TURN OFF. • This function will be unavailable when the Transition Detector is on ([51]).
AUTO ON	<p>Using the ▲/▼ buttons turns on/off the AUTO ON function. TURN ON ⇔ TURN OFF</p> <p>When AUTO ON is set to TURN ON, the projector's lamp will only be automatically turned on when the Power switch is turned on if the power was turned off using the Power switch the last time the projector was turned off.</p> <ul style="list-style-type: none"> • After turning the lamp on by the AUTO ON function, if neither input nor operation is detected for about 30 minutes, the projector is turned off, even though the AUTO OFF function ([43]) is disabled.

(continued on next page)

OPTION Menu (continued)

Item	Description
<p>AUTO OFF</p>	<p>Using the ▲/▼ buttons adjusts the time to count down to automatically turn the projector off. Long (max. 99 minutes) ⇔ Short (min. 0 minute = DISABLE)</p> <div style="display: flex; justify-content: space-around; align-items: center;"> <div style="border: 1px solid black; padding: 5px; text-align: center;"> <p>◀ AUTO OFF ENABLE ▲ 1 ▼</p> </div> <div style="border: 1px solid black; padding: 5px; text-align: center;"> <p>◀ AUTO OFF DISABLE ▲ 0 ▼</p> </div> </div> <p>When the time is set to 0, the projector is not turned off automatically. When the time is set to 1 to 99, and when the passed time with no-signal or an unsuitable signal reaches at the set time, the projector lamp will be turned off. If one of the projector's buttons or the remote control buttons is pressed or one of the commands (except get commands) is transmitted to the control port during the corresponding time, projector will not be turned off. Please refer to the section "Turning off the power" (📖16).</p>
<p>LAMP TIME</p>	<p>The lamp time is the time counted after the last resetting. It is shown in the OPTION menu as the usage time of the lamp. Pressing the RESET button on the remote control or the ► button of the projector displays a dialog. To reset the lamp time, select the RESET using the ▲ button. RESET ⇔ CANCEL</p> <ul style="list-style-type: none"> • Please reset the lamp time only when you have replaced the lamp, for a suitable indication about the lamp. • For the lamp replacement, see the section "Lamp" (📖56, 57).
<p>FILTER TIME</p>	<p>The filter time is the time counted after the last resetting. It is shown in the OPTION menu as the usage time of the air filter. Pressing the RESET button on the remote control or the ► button of the projector displays a dialog. To reset the filter time, select the RESET using the ▲ button. RESET ⇔ CANCEL</p> <ul style="list-style-type: none"> • Please reset the filter time only when you have cleaned or replaced the air filter, for a suitable indication about the air filter. • For the air filter cleaning, see the section "Air filter" (📖58, 59).

(continued on next page)

OPTION Menu

OPTION Menu (continued)

Item	Description
<p>MY BUTTON</p>	<p>This item is to assign one of the following function to MY BUTTON 1 and 2 on the remote control (📖6). Choose 1 or 2 on the MY BUTTON menu using the ◀/▶ button first. Then using the ▲/▼ buttons sets one of the following functions to the chosen button.</p> <ul style="list-style-type: none"> • RGB1: Sets port to RGB1. • RGB2: Sets port to RGB2. • M1-D: Sets port to M1-D. • COMPONENT: Sets port to COMPONENT (Y, Cb/Pb, Cr/Pr). • S-VIDEO: Sets port to S-VIDEO. • VIDEO: Sets port to VIDEO. • e-SHOT: Displays the e-SHOT menu (📖54). • INFORMATION: Displays a dialog of INPUT INFORMATION (📖46). • AUTO KEYSTONE [↔] EXECUTE: Performs automatic keystone distortion correction (📖35). • MY MEMORY: Loads one of adjustment data stored (📖28). • When the current adjustment is not saved to memory a dialog is displayed. <div data-bbox="506 890 1156 991" style="border: 1px solid black; padding: 5px;"> <p>Temporary condition</p> <p>MEMORY : Recall saved parameters No saved data</p> <p>◀ : Quit</p> </div> <p>If you want to keep the current adjustment, please press the ◀ button to quit. Otherwise the current adjusted condition will be lost by loading a data.</p> <ul style="list-style-type: none"> • PICTURE MODE: Changes the PICTURE MODE (📖24). • FILTER RESET: Displays the filter time reset confirmation dialogue (📖43). • ACTIVE IRIS: Changes the active iris mode. • VOLUME+: Set the volume up. • VOLUME-: Set the volume down.
<p>SERVICE</p>	<p>Selecting this item displays the SERVICE menu. Select an item using the ▲/▼ buttons, and press the ▶ button or the ENTER button on the remote control to execute the item.</p> <p>FAN SPEED ↔ AUTO ADJUST ↔ GHOST ↔ FILTER MESSAGE ↔ LENS TYPE ↔ KEY LOCK</p> <p style="text-align: center;">↙ ↘</p> <p style="text-align: center;">FACTORY RESET ↔ INFORMATION ↔ REMOTE FREQ. ↔ REMOTE RECEIV. ↖</p> <p>FAN SPEED</p> <p>Using the ▲/▼ buttons switches the rotation speed of the cooling fans. The HIGH is the mode for use at highlands etc. Note that the projector is noisier when the HIGH is selected.</p> <p>HIGH ↔ NORMAL</p> <div data-bbox="1269 1604 1425 1705" style="border: 1px solid black; padding: 5px; width: fit-content;"> <p>FANSPEED</p> <p>● HIGH</p> <p>○ NORMAL</p> </div>

(continued on next page)

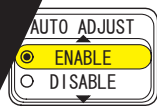

... signal cable to
... C., the automatic
... e, please
... tment, and make



buttons to



OPTION Menu

OPTION Menu (continued)

Item	Description
<p>SERVICE</p>	<p>KEY LOCK Using the ▲/▼ buttons turns on/off the key lock feature. When TURN ON is selected, the buttons on the projector except the STANDBY/ON button are locked. TURN ON ⇔ TURN OFF</p> <ul style="list-style-type: none"> • Please use to avoid a mischief and touching accidentally. This function does not have any effect on the remote control. <p>REMOTE RECEIV. (1) Select a remote sensor using the ▲/▼ button. 1:FRONT ⇔ 2:TOP ⇔ 3:REAR (2) Switch it using the ENTER button <input type="checkbox"/> (off) ⇔ <input checked="" type="checkbox"/> (on)</p> <ul style="list-style-type: none"> • A sensor cannot be turned off when the other two are off. Always at least one sensor is on. <p>REMOTE FREQ. Use the ▲/▼ button to change the Projector's remote sensor setting (📖14). 1:NORMAL ⇔ 2:HIGH</p> <p>Items with a checkmark are on. The factory default setting is for both 1:NORMAL and 2: HIGH to be on. If the remote control does not function correctly set the this to either only 1 or only 2 as described in Remote Control Settings (📖14). Neither can be turned off at the same time.</p> <p>INFORMATION Selecting this item displays a dialog titled “INPUT INFORMATION”. It shows the information about the current input.</p> <div style="display: flex; justify-content: space-around; align-items: flex-start;"> <div style="border: 1px solid black; padding: 5px; width: 30%; text-align: center;"> <p>◀ INPUT-INFORMATION</p> <p>RGB1</p> <p>1024x768 @60Hz</p> <p>FRAME LOCK</p> </div> <div style="border: 1px solid black; padding: 5px; width: 30%; text-align: center;"> <p>◀ INPUT-INFORMATION</p> <p>S-VIDEO</p> <p>SECAM</p> <p>AUTO</p> </div> <div style="border: 1px solid black; padding: 5px; width: 30%; text-align: center;"> <p>◀ INPUT-INFORMATION</p> <p>COMPONENT</p> <p>576i @50</p> <p>SCART RGB</p> </div> </div> <ul style="list-style-type: none"> • The “FRAME LOCK” message on the dialog means the frame lock function is working. • The “SCART RGB” message means the COMPONENT VIDEO port is working as a SCART RGB input port. Please refer to the COMPONENT item in INPUT menu (📖32). • This item can't be selected for no signal and sync out. <p>FACTORY RESET Selecting RESET using the button ▲ performs this function. By this function, all the items in all of menus will collectively return to the initial setting. Note that the items LAMP TIME, FILTER TIME, LANGUAGE and SECURITY are not reset. RESET ⇔ CANCEL</p>

(continued on next page)

OPTION Menu (continued)

Item	Description
<p>SECURITY</p>	<p>This projector is equipped with security functions. User registration is required before using the security functions. Please contact your local dealer.</p> <p>1. Using Security Features</p> <p>1.1 Inputting the PASSWORD</p> <p>1.1-1 Use the ▲/▼ buttons on the OPTION menu to select SECURITY and press the ► button. The ENTER PASSWORD box will be displayed. The factory default PASSWORD is 8401. This PASSWORD can be changed (1.2 Changing the PASSWORD).</p> <ul style="list-style-type: none"> It is strongly recommended the factory default PASSWORD to be changed as soon as possible. <p>1.1-2 Use the ▲/▼/◀/▶ buttons to enter the registered PASSWORD. Move the cursor to the right side of the ENTER PASSWORD BOX and press the ► button to display the SECURITY menu. If an incorrect PASSWORD is input the ENTER PASSWORD BOX will be displayed again. If incorrect PASSWORD is input 3 times the projector will turn off. Afterwards the projector will turn off every time an incorrect PASSWORD is input.</p> <p>1.2 Changing the PASSWORD</p> <p>1.2-1 Use the ▲/▼ buttons on the SECURITY menu to select SECURITY PASSWORD CHANGE and press the ► button to display the ENTER NEW PASSWORD BOX.</p> <p>1.2-2 Use the ▲/▼/◀/▶ buttons to enter the new PASSWORD.</p> <p>1.2-3 Move the cursor to the right side of the ENTER NEW PASSWORD BOX and press the ► button to display the NEW PASSWORD AGAIN BOX, enter the same PASSWORD again.</p> <p>1.2-4 Move the cursor to the right side of the NEW PASSWORD AGAIN BOX and press the ► button and the NOTE NEW PASSWORD BOX will be displayed for about 20 seconds, please make note of the PASSWORD during this time. Pressing the ENTER button on the remote control or INPUT button on the projector will close the NOTE NEW PASSWORD BOX.</p> <ul style="list-style-type: none"> Please do not forget your PASSWORD.



ENTER PASSWORD BOX

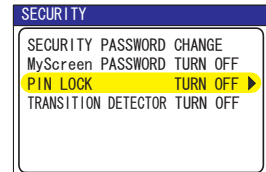

SECURITY MENU



ENTER NEW PASSWORD BOX



NEW PASSWORD AGAIN BOX



NOTE NEW PASSWORD BOX

(continued on next page)

OPTION Menu

OPTION Menu (continued)

Item	Description
<p style="text-align: center;">SECURITY</p>	<p>1.3 If you have forgotten your PASSWORD</p> <p>1.3-1 Follow the procedure in 1.1-1 to display the ENTER PASSWORD BOX.</p> <p>1.3-2 While the ENTER PASSWORD BOX is displayed, press and hold the RESET button on the remote control for about 3 seconds or press and hold the INPUT and ► buttons on the projector for about 3 seconds. The 10-digit Inquiring Code will be displayed. NOTE: If there is no key input for about 55 seconds while the Inquiring Code is displayed the menu will close. If necessary repeat the process from 1.3-1.</p> <p>1.3-3 Contact your dealer with the 10 digit Inquiring Code. Your PASSWORD will be sent after your user registration information is confirmed.</p>
	<p>2. Using the MyScreen PASSWORD Function</p> <p>The MyScreen PASSWORD function can be used to prohibit access to the MyScreen function and prevent the currently registered MyScreen image from being overwritten.</p> <p>2.1 Turning on the MyScreen PASSWORD Function</p> <p>2.1-1 Use the ▲/▼ buttons on the SECURITY menu to select MyScreen PASSWORD and press the ► button to display the MyScreen PASSWORD on/off menu.</p>
	<p>2.2 Setting the PASSWORD</p> <p>2.2-1 Display the MyScreen on/off menu using the procedure in 2.1-1.</p> <p>2.2-2 Use the ▲/▼ buttons on the MyScreen PASSWORD on/off menu to select TURN ON. The ENTER PASSWORD BOX (small) will be displayed.</p> <p>2.2-3 Use the ▲/▼/◀/▶ buttons to enter the PASSWORD. Move the cursor to the right side of the ENTER PASSWORD BOX (small) and press the ► button to display the CHECK PASSWORD BOX, enter the same PASSWORD again.</p>



Inquiring Code (PASSWORD)

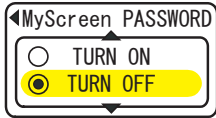

MyScreen PASSWORD on/off menu

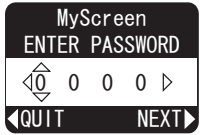

ENTER PASSWORD BOX (small)

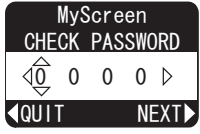

CHECK PASSWORD BOX

(continued on next page)

OPTION Menu (continued)

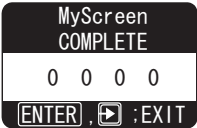
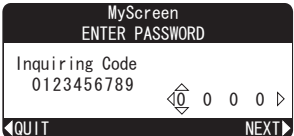
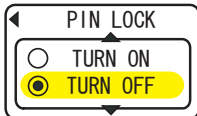
Item	Description
<p>SECURITY</p>	<p>2.2-4 Move the cursor to the right side of the CHECK PASSWORD BOX and press the ► button to display the PASSWORD for about 20 seconds, please make note of the PASSWORD during this time.</p>  <p>PRESSING THE ENTER button on the remote control or INPUT button on the projector will return to MyScreen PASS WORD on/off menu.</p> <p>When a PASSWORD is set for MyScreen:</p> <ul style="list-style-type: none"> • The MyScreen registration function (and menu) will be unavailable. • The MyScreen Lock function (and menu) will be unavailable. • The START UP setting will be locked on MyScreen (and the menu will be unavailable). <p>Turning the MyScreen PASSWORD off will allow normal operation of both functions.</p> <ul style="list-style-type: none"> • Please do not forget your MyScreen PASSWORD. <p>2.3 Turning the PASSWORD off</p> <p>2.3-1 Follow the procedure in 2.1-1 to display the MyScreen PASSWORD on/off menu.</p> <p>2.3-2 Select TURN OFF to display the ENTER PASSWORD BOX (large). Enter the registered PASSWORD and the screen will return to the MyScreen on/off menu.</p> <p>If an incorrect PASSWORD is input the menu will close. If necessary repeat the process from 2.3-1.</p>
	<p>2.4 If you have forgotten your PASSWORD</p> <p>2.4-1 Follow the procedure in 2.1-1 to display the MyScreen PASSWORD on/off menu.</p> <p>2.4-2 Select TURN OFF to display the ENTER PASSWORD BOX (large). The 10-digit Inquiring Code will be displayed inside the BOX.</p>  <p>2.4-3 Contact your dealer with the 10-digit Inquiring Code. Your PASSWORD will be sent after your user registration information is confirmed.</p> <p>3. Using the PIN LOCK Function</p> <p>PIN LOCK is a function which prevents the projector from being used unless a registered Code is input.</p> <p>3.1 Registering the PIN Code</p> <p>3.1-1 Use the ▲/▼ buttons on the SECURITY menu to select PIN LOCK and press the ► button or the ENTER button to display the PIN LOCK on/off menu.</p>  <p>3.1-2 Use the ▲/▼ buttons on the PIN LOCK on/off menu to select TURN ON and the PIN BOX will be displayed.</p>

(continued on next page)

OPTION Menu

OPTION Menu (continued)

Item	Description
<p>SECURITY</p>	<p>3.1-3 Input a 4 part PIN Code using the ▲/▼/◀/▶ /RGB and INPUT buttons. A CONFIRMATION BOX will appear. Reenter the same PIN Code. This will complete the PIN Code registration.</p> <p>NOTE: If there is no key input for about 55 seconds while the PIN BOX or the CONFIRMATION BOX are displayed the menu will close. If necessary repeat the process from 3.1-1.</p> <p>Afterwards, anytime the projector is restarted after the power switch is turned off the PIN BOX will be displayed. Enter the registered PIN Code. The projector can be used after entering the registered PIN Code. If an incorrect PIN Code is input the PIN BOX will be displayed again. If an incorrect PIN Code is input 3 times the projector will turn off. Afterwards the projector will turn off every time an incorrect PIN Code is input. The projector will also turn off if there is no key input for about 5 minutes while the PIN BOX is displayed. This function will activate only when the projector is started after the power switch was turned off.</p> <ul style="list-style-type: none"> • Please do not forget your PIN Code. <p>3.2 Turning Off the PIN LOCK Function</p> <p>3.2-1 Follow the procedure in 3.1-1 to display the PIN LOCK on/off menu. Use the ▲/▼ buttons to select TURN OFF and the PIN BOX will be displayed. Enter the registered PIN Code to turn the PIN LOCK function off. If an incorrect PASSWORD is entered the menu will close.</p> <p>3.3 If you have forgotten your PIN Code</p> <p>3.3-1 While the PIN BOX is displayed, press and hold the RESET button for three seconds or press and hold the INPUT and ► buttons for three seconds. The 10 digit Inquiring Code will be displayed.</p> <p>NOTE: If there is no key input for about 5 minutes while the Inquiring Code is displayed the projector will turn off.</p> <p>3.3-2 Contact your dealer with the 10-digit Inquiring Code. Your PASSWORD will be sent after your user registration information is confirmed.</p>

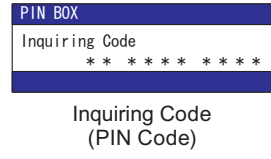
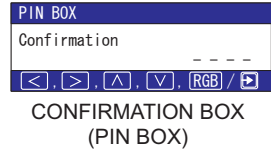
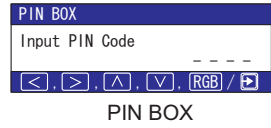

(continued on next page)

OPTION Menu (continued)

Item	Description
<p>SECURITY</p>	<p>4. Using the Transition Detector Function</p> <p>While the Transition Detector function is ON, when power switch is started to supply to the projector, it might react as below.</p> <ul style="list-style-type: none"> • Transition Detector alarm shown below might appear on screen, if the projector has been moved or re-installed. • Transition Detector alarm might appear on screen, if the MIRROR setting has been changed. • Keystone adjustment feature has been prohibited as long as the Transition Detector function is ON. <p>4.1 Turning On the Transition Detector Function</p> <p>4.1-1 Use the ▲/▼ buttons on the SECURITY menu to select TRANSITION DETECTOR and press the ► or the ENTER button to display the TRANSITION DETECTOR on/off menu. Select TURN ON and the current angle and mirror setting will be recorded.</p>  <p>NOTE: This feature may not function properly if the projector is not in a stable position when TURN ON is selected.</p> <p>4.1-2 If this function is set to TURN ON when the vertical angle of the projector or mirror setting at which the projector is turned on is different than the previously recorded the Transition Detector Alarm will be displayed and the projector will not display the input signal.</p> <p>If the Transition Detector ALARM is displayed for about 5 minutes the lamp will turn off. This function will activate only when the projector is started after the power switch was turned off.</p> <p>4.2 Setting the Transition Detector PASSWORD</p> <p>4.2-1 Use the ▲/▼ buttons on the SECURITY menu to select TRANSITION DETECTOR and press the ► or the ENTER button to display the TRANSITION DETECTOR on/off menu.</p> <p>4.2-2 Use the ▲/▼ buttons on the TRANSITION DETECTOR on/off menu to select TURN ON. The ENTER PASSWORD BOX (small) will be displayed.</p> <p>4.2-3 Use the ▲/▼/◀/▶ buttons to enter a PASSWORD. Move the cursor to the right side of the ENTER PASSWORD BOX (small) and press the ► button to display the CHECK PASSWORD BOX, enter the same PASSWORD again.</p> <p>4.2-4 Move the cursor to the right side of the CHECK PASSWORD BOX and press the ► button to display the PASSWORD for about 20 seconds, please make note of the PASSWORD during this time.</p> <p>Pressing the ENTER button on the remote control or the INPUT button on the projector will return to the TRANSITION DETECTOR on/off menu.</p> <ul style="list-style-type: none"> • Please do not forget your Transition Detector PASSWORD.

OPTION Menu

OPTION Menu (continued)

Item	Description
<p>SECURITY</p>	<p>4.3 Setting the Transition Detector off</p>
	<p>4.3-1 Follow the procedure in 4.1-1 to display the TRANSITION DETECTOR on/off menu.</p>
	<p>4.3-2 Select TURN OFF to display the ENTER PASSWORD BOX (large). Enter the registered PASSWORD and the screen will return to the TRANSITION DETECTOR on/off menu. If an incorrect PASSWORD is input the menu will close. If necessary repeat the process from 4.3-1.</p>
	<p>4.4 If you have forgotten your PASSWORD</p>
	<p>4.4-1 Follow the procedure in 4.1-1 to display the TRANSITION DETECTOR on/off menu.</p>
	<p>4.4-2 Select TURN OFF to display the ENTER PASSWORD BOX (large). The 10-digit Inquiring Code will be displayed inside the BOX.</p>
	<p>4.4-3 Contact your dealer with the 10-digit Inquiring Code. Your PASSWORD will be sent after your user registration information is confirmed.</p>

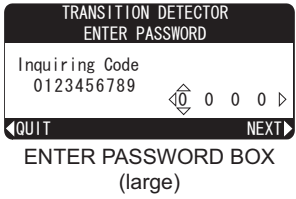

NETWORK Menu

Consult with your network administrator before connecting to an existing access point on your network. Incorrect network settings on this projector may cause trouble on the network.

Select "NETWORK" from the main menu to access the following functions.

Select an item using the ▲/▼ cursor buttons on the projector or remote control, and press the ► cursor button on the projector or remote control, or ENTER button on the remote control to execute the item. Then perform it according to the following table.

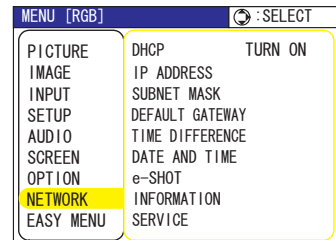

NOTE • The factory default setting for DHCP is "TURN ON". There is no need to set up [DHCP], [IP ADDRESS], [SUBNET MASK] or [DEFAULT GATEWAY] if your network has DHCP enabled. (📖 **User's Manual - Network Functions**)

- If you are not utilizing SNTP (📖 **User's Manual - Network Functions**), then you must set the DATE AND TIME during the initial installation. Please refer to the item DATE AND TIME on the following list.

Item	Description
DHCP (Dynamic Host Configuration Protocol)	<p>DHCP TURN ON/TURN OFF: Use the ▲/▼ buttons to turn DHCP on/off TURN ON ⇔ TURN OFF</p>  <p>Select TURN OFF when the network does not have DHCP enabled.</p>
IP ADDRESS	<p>Entering the IP ADDRESS : Use the ▲/▼/◀/▶ buttons to enter the IP ADDRESS. This function can only be used when DHCP is set to "TURN OFF".</p> <ul style="list-style-type: none"> • The IP ADDRESS is the number that identifies this projector on the network. You cannot have two devices with the same IP ADDRESS on the same network.
SUBNET MASK	<p>Entering the SUBNET MASK : Use the ▲/▼/◀/▶ buttons to enter the same SUBNET MASK used by your PC. This function can only be used when DHCP is set to "TURN OFF".</p>
DEFAULT GATEWAY	<p>Entering the DEFAULT GATEWAY : Use the ▲/▼/◀/▶ buttons to enter the DEFAULT GATEWAY (a node on a computer network that serves as an access point to another network) address. This function can only be used when DHCP is set to "TURN OFF".</p>

NETWORK Menu

NETWORK Menu (continued)

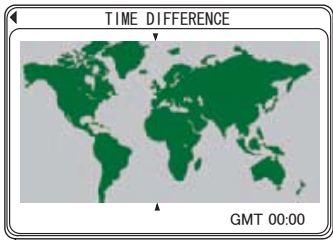
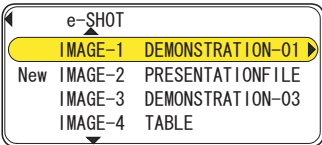
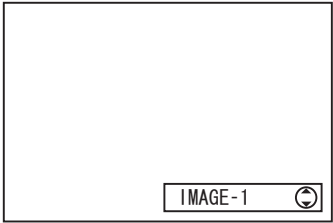
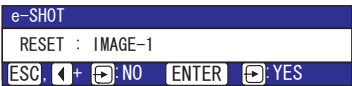
Item	Description
<p>TIME DIFFERENCE</p>	<p>Entering the TIME DIFFERENCE : Use the ▲/▼ buttons to enter the TIME DIFFERENCE. Set the same TIME DIFFERENCE as the one set on your PC. If unsure, consult your network administrator. Use the ◀ button to return to the menu after setting the TIME DIFFERENCE.</p> 
<p>DATE AND TIME</p>	<p>Entering DATE AND TIME : Use the ▲/▼/◀/▶ buttons to enter the Year (last two digits), Month, Date, Hour and Minute.</p> <ul style="list-style-type: none"> The projector will override this setting and retrieve DATE AND TIME information from the Timeserver when SNTP is enabled. See [Date/ Time Settings] in [User’s Manual - Network Functions: Configuring and Controlling the Projector via a Web Browser] for SNTP settings.
<p>e-SHOT</p>	<p>e-SHOT display : Use the ▲/▼ buttons to select an item and the ▶ or ENTER buttons to display the image.</p> <p>Image1 Image2 Image3 Image4</p>  <p>File names of registered images are displayed by 16 characters or less. Example: DEMONSTRATION-01 “NEW” stamp is added to the head of line when the image is registered newly. After the image is displayed, “NEW” stamp will be erased.</p>  <p>Once an image is displayed, you can use the ▲/▼ buttons to page through the images. Use the ◀ or ESC buttons to return to the menu.</p> <p>Pressing the RESET button or the ▶ button for about 3 seconds while an image is being displayed will display the RESET menu. The displayed image can be deleted from the RESET menu using the ENTER button on the remote control or the INPUT button on the projector.</p> <p>If you do not wish to delete the image use the ESC button on the remote control or push the ◀ and INPUT buttons on the projector at the same time.</p> <ul style="list-style-type: none"> Items with no image stored cannot be selected. Images can be changed using the ▲/▼ buttons while the image data downloads. 

(continued on next page)

NETWORK Menu (continued)

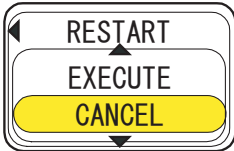
Item	Description
INFORMATION	<p>INFORMATION display : Use the ► or ENTER buttons to view network information and confirm settings.</p> <div style="border: 1px solid black; padding: 5px; width: fit-content; margin: 10px auto;"> <p style="text-align: center;">◀ NETWORK-INFORMATION</p> <p>NAME</p> <p>IP ADDRESS 192.1.254</p> <p>SUBNETMASK 255.255.255.0</p> <p>DEFAULT GATEWAY 0.0.0.0</p> <p>MAC ADDRESS 00:00:87:56:AC:7C</p> <p>TIME DIFFERENCE GMT +00:00</p> <p>DATE AND TIME 2000/1/1 8:15</p> </div> <ul style="list-style-type: none"> • Only the first 16 characters of the projector name are displayed. • The battery for the built in clock may be dead if the clock loses time even when the DATE AND TIME have been set correctly. Replace the battery by following the instructions on replacing the battery. (📖60)
SERVICE	<p>Choose the RESTART using the ► button.</p> <div style="text-align: center; margin: 10px 0;">  </div> <p>Then use the ▲ button to execute.</p> <div style="text-align: center; margin: 10px 0;">  </div> <p>Network will be once cut off when choose restart. If DHCP is selected on, IP address may be changed. After selecting RESTART, Network menu may not be controlled approx. 20 seconds.</p>

Network functions

Refer to the separate volume on Network Functions.

Maintenance

Lamp

A lamp has finite product life. Using the lamp for long periods of time could cause the pictures darker or the color tone poor. Note that each lamp has a different lifetime, and some may burst or burn out soon after you start using them.

Preparation of a new lamp and early replacement are recommended. To prepare a new lamp, contact your dealer and tell the lamp type number.

Type number = 78-6969-9893-5

Replacing the lamp

1. Turn the projector off, and unplug the power cord.
Allow the projector to cool for at least 45 minutes.
2. Prepare a new lamp.
If the projector is mounted on a ceiling, or if the lamp has broken, also ask the dealer to replace the lamp.

In case of replacement by yourself,

3. Loosen the screw (marked by arrow) of the lamp door and then slide the lamp door to the side to remove it.
4. Loosen the 3 screws (marked by arrow) of the lamp, and slowly pick up the lamp by the handles.
5. Insert the new lamp, and retighten firmly the 3 screws of the lamp that are loosened in the previous process to lock it in place.
6. Slide the lamp door back in place and firmly fasten the screw of the lamp door.
7. Turn the projector on and reset the lamp time using the LAMP TIME item in the OPTION menu (43).

- (1) Press the MENU button to display a menu.
- (2) Point at the "Go to Advanced Menu ..." in the menu using the ▼/▲ button, then press the ► button.
- (3) Point at the "OPTION" in the left column of the menu using the ▼/▲ button, then press the ► button.
- (4) Point at the "LAMP TIME" using the ▼/▲ button, then press the ► button. A dialog will appear.
- (5) Press the ▲ button to select "RESET" on the dialog. It performs resetting the lamp time.

The lamp door

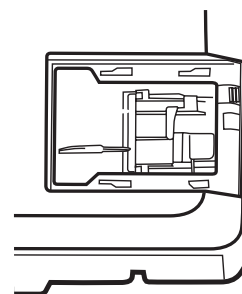
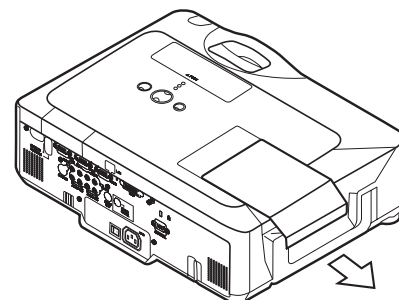
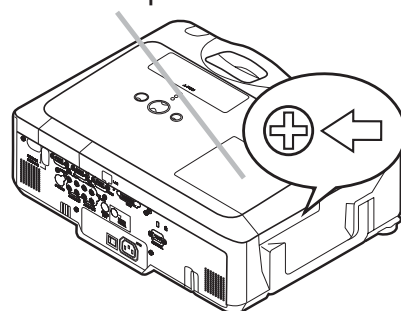

NOTE • Please reset the lamp time only when you have replaced the lamp, for a suitable indication about the lamp.

Lamp (continued)**WARNING**

HIGH VOLTAGE



HIGH TEMPERATURE



HIGH PRESSURE

► The projector uses a high-pressure mercury glass lamp. The lamp can break with a loud bang, or burn out, if jolted or scratched, handled while hot, or worn over time. Note that each lamp has a different lifetime, and some may burst or burn out soon after you start using them. In addition, when the bulb bursts, it is possible for shards of glass to fly into the lamp housing, and for gas containing mercury to escape from the projector's vent holes.

► **About disposal of a lamp** • This product contains a mercury lamp; do not put it in a trash. Dispose of it in accordance with environmental laws. For lamp recycling, go to www.lamprecycle.org. (in the US) For product disposal, contact your local government agency or www.eiae.org (in the US) or www.epsc.ca (in Canada). For more information, call your dealer.



Disconnect the plug from the power outlet

- If the lamp should break (it will make a loud bang when it does), unplug the power cord from the outlet, and make sure to request a replacement lamp from your local dealer. Note that shards of glass could damage the inside of the projector, or cause injury during handling, so please do not try to clean the projector or replace the lamp yourself.
- If the lamp should break (it will make a loud bang when it does), ventilate the room well, and make sure not to breathe the gas that comes out of the projector vents, or get it in your eyes or mouth.
- Before replacing the lamp, turn the projector off and unplug the power cord, then wait at least 45 minutes for the lamp to cool sufficiently. Handling the lamp while hot can cause burns, as well as damaging the lamp.



- Never unscrew except the appointed (marked by an arrow) screws.
- Do not open the lamp door while the projector is suspended from the ceiling. This is dangerous, since if the lamp's bulb has broken, the shards will fall out when the cover is opened. In addition, working in high places is dangerous, so ask your local dealer to have the lamp replaced even if the bulb is not broken.
- Do not use the projector with the lamp door removed. To replace the lamp, make sure that the screws are tightened firmly. Loose screws could result in damage or injury.



- Use only the lamp of the specified type.
- If the lamp breaks soon after the first time it is used, it is possible that there are electrical problems elsewhere besides the lamp. If this happens, contact your local dealer or a service representative.
- Handle with care: jolting or scratching could cause the lamp bulb to burst during use.
- Using the lamp for long periods of time could cause it dark, not to light up or to burst. When the pictures appear dark, or when the color tone is poor, please replace the lamp as soon as possible. Do not use old (used) lamps; this is a cause of breakage.

Air filter

Please check and clean the air filter periodically. If the air filter becomes clogged by dust or the like, internal temperatures rise, which could cause a fire, a burn or malfunction to the projector. When the indicators or a message prompts you to clean the air filter, comply with it as soon as possible. Note that the projector may shut down, when the projector heats too much.

Please replace the air filter when it is damaged or too soiled. Preparation of a new air filter is recommended. To prepare a new air filter, contact with your dealer and tell the air filter type number.

Type number = 78-8118-9803-6

Cleaning the air filter

1. Turn the projector off, and unplug the power cord. Allow the projector to sufficiently cool down.
2. Use a vacuum cleaner on and around the filter cover.
3. Hold the filter cover knobs while lifting it. The filter unit made up the filter cover and others will come off.
4. Use a vacuum cleaner for the filter vent of the projector and the filter frame side of the filter unit.
If the air filter is damaged or too soiled, replace it according to the following procedure number 5 to 7. Otherwise, please jump to the procedure number 8.
5. To remove the filter frame, hold the filter cover while holding and pulling the filter frame's knob by another hand.
6. Replace the air filter with new one. It is recommended that the fluted surface of the air filter faces the filter cover.
7. Put the filter frame back.
8. Put the filter unit back into the projector.

The front side of the projector

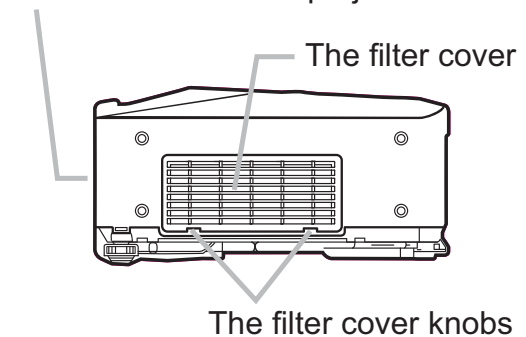

The filter unit

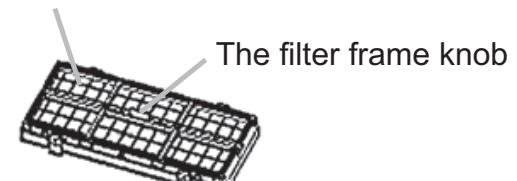

The filter frame

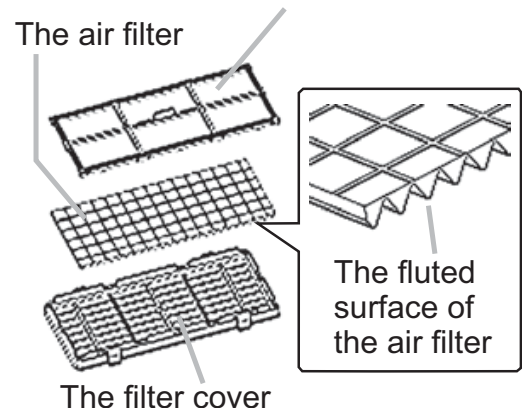

(continued on next page)

Air filter (continued)

9. Turn the projector on and reset the filter time using the FILTER TIME item in the EASY MENU (📖25).

- (1) Press the MENU button to display a menu.
- (2) Point at the “FILTER TIME” using the ▼/▲ button, then press the ► button. A dialog will appear.
- (3) Press the ▲ button to select “RESET” on the dialog. It performs resetting the filter time.

⚠WARNING ► Before taking care of the air filter, make sure the power switch is off and the power cable is not plugged in, then allow the projector to cool sufficiently. Taking care of the air filter in a high temperature state of the projector could cause an electric shock, a burn or malfunction to the projector.

► Use only the air filter of the specified type. Do not use the projector without the air filter or the filter cover. It could result in a fire or malfunction to the projector.

► Clean the air filter periodically. If the air filter becomes clogged by dust or the like, internal temperatures rise and could cause a fire, a burn or malfunction to the projector.

NOTE • Please replace the air filter when it is damaged or too soiled, and also when you replace the lamp.

- When you replace the projection lamp, please replace the air filter. An air filter of specified type will come together with a replacement lamp for this projector.
- Please reset the filter time only when you have cleaned or replaced the air filter, for a suitable indication about the air filter.
- The projector may display the message such as “CHECK THE AIR FLOW” or turn off the projector, to prevent the internal heat level rising.

1. Turn the projector off, and unplug the power cord. Allow the projector to cool sufficiently.
2. After making sure that the projector has cooled adequately, slowly turn over the projector, so that the bottom is facing.
3. Remove the battery cover.
Turn the battery cover in the direction indicated "OPEN" using such as coins. Then the battery cover will come up. While removing the battery cover, pick its knob.
4. Take the old battery out.
Press the metal claw of the battery holder. Then the battery will come up. Remove the battery.
5. Put a new battery in.
Replace battery with HITACHI MAXELL, Part No.CR2032 only. Use of another battery may present a risk of fire or explosion.
Insert a new battery in the battery holder according to its minus terminal \ominus as indicated in the battery holder, so that the side marked by + is facing. And push the battery into the battery holder fully to fix.
6. Close the battery cover.
Replace the battery cover in place, then turn it in the direction indicated "CLOSE" using such as coins, to fix.

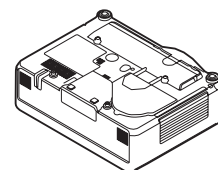

Other care

Inside of the projector

In order to ensure the safe use of your projector, please have it cleaned and inspected by your dealer about once every year.

Caring for the lens

If the lens is flawed, soiled or fogged, it could cause deterioration of display quality. Please take care of the lens, being cautious of handling.

1. Turn the projector off, and unplug the power cord. Allow the projector to cool sufficiently.
2. After making sure that the projector is cool adequately, lightly wipe the lens with a commercially available lens-cleaning wipe. Do not touch the lens directly with your hand.

Caring for the cabinet and remote control

Incorrect care could have adverse influence such as discoloration, peeling paint, etc.

1. Turn the projector off, and unplug the power cord. Allow the projector to cool sufficiently.
2. After making sure that the projector is cool adequately, lightly wipe with gauze or a soft cloth.

If the projector is extremely dirty, dip soft cloth in water or a neutral cleaner diluted in water, and wipe lightly after wringing well. Then, wipe lightly with a soft, dry cloth.

⚠WARNING ► Before caring, make sure the power switch is off and the power cable is not plugged in, and then allow the projector to cool sufficiently. The care in a high temperature state of the projector could cause a burn and/or malfunction to the projector.

► Never try to care for the inside of the projector personally. Doing is so dangerous.

► Avoid wetting the projector or inserting liquids in the projector. It could result in a fire, an electric shock, and/or malfunction to the projector.

• Do not put anything containing water, cleaners or chemicals near the projector.

• Do not use aerosols or sprays.

⚠CAUTION ► Please take right care of the projector according to the following. Incorrect care could cause not only an injury but adverse influence such as discoloration, peeling paint, etc.

► Do not use cleaners or chemicals other than those specified in this manual.

► Do not polish or wipe with hard objects.

Troubleshooting

Related messages

When the unit's power is on, messages such as those shown below may be displayed. When any such message is displayed on the screen, please follow the instructions described below. If the same message is displayed after the remedy, or if a message other than the following appears, please contact your dealer or service company.

Although these messages will be automatically disappeared around several minutes, it will be reappeared every time the power is turned on.

Message	Description
<div style="border: 1px solid black; padding: 5px; text-align: center;"> NO INPUT IS DETECTED *** </div>	<p>There is no input signal. Please confirm the signal input connection, and the status of the signal source.</p>
<div style="border: 1px solid black; padding: 5px; text-align: center;"> SYNC IS OUT OF RANGE *** [fH] **kHz [fV] **Hz </div>	<p>The horizontal or vertical frequency of the input signal is not within the specified range. Please confirm the specs for your projector or the signal source specs.</p>
<p style="text-align: center;">CHECK THE AIR FLOW</p>	<p>The internal temperature is rising. Please turn the power off, and allow the projector to cool down at least 20 minutes. After having confirmed the following items, please turn the power ON again.</p> <ul style="list-style-type: none"> • Is there blockage of the air passage aperture? • Is the air filter dirty? • Does the peripheral temperature exceed 35°C? <p>If the same indication is displayed after the remedy, please set FAN SPEED of the SERVICE item in the OPTION menu to HIGH.</p>
<p style="text-align: center;">REMINDER *** HRS PASSED AFTER THE LAST FILTER CHECK. FILTER MAINTENANCE IS ESSENTIAL TO REMOVE WARNING MESSAGE, RESET FILTER TIMER. SEE MANUAL FURTHER INFO.</p>	<p>A note of precaution when cleaning the air filter. Please immediately turn the power off, and clean or change the air filter referring to the “Air Filter” section of this manual (45). After you have cleaned or changed the air filter, please be sure to reset the filter timer (43).</p>

Regarding the indicator lamps

Lighting and flashing of the POWER indicator, the LAMP indicator, and the TEMP indicator have the meanings as described in the table below. Please follow the instructions within the table. If the same indication is displayed after the remedy, or if an indication other than the following is displayed, please contact your dealer or service company.

POWER indicator	LAMP indicator	TEMP indicator	Description
Lighting In Orange	Turned off	Turned off	The projector is in a standby state. Please refer to the section "Power On/Off".
<i>Blinking</i> In Green	Turned off	Turned off	The projector is warming up. Please wait.
Lighting In Green	Turned off	Turned off	The projector is in an on state. Ordinary operations may be performed.
<i>Blinking</i> In Orange	Turned off	Turned off	The projector is cooling down. Please wait.
<i>Blinking</i> In Red	(discre- tionary)	(discre- tionary)	The projector is cooling down. A certain error has been detected. Please wait until the POWER indicator finishes blinking, and then perform the proper measure using the item descriptions below.
<i>Blinking</i> In Red or Lighting In Red	Lighting In Red	Turned off	The lamp does not light, and there is a possibility that interior portion has become heated. Please turn the power off, and allow the projector to cool down at least 20 minutes. After the projector has sufficiently cooled down, please make confirmation of the following items, and then turn the power on again. <ul style="list-style-type: none"> • Is there blockage of the air passage aperture? • Is the air filter dirty? • Does the peripheral temperature exceed 35°C? If the same indication is displayed after the remedy, please change the lamp referring to the section "Lamp".
<i>Blinking</i> In Red or Lighting In Red	<i>Blinking</i> In Red	Turned off	The lamp door has not been properly fixed. Please turn the power off, and allow the projector to cool down at least 45 minutes. After the projector has sufficiently cooled down, please make confirmation of the attachment state of the lamp door. After performing any needed maintenance, turn the power on again. If the same indication is displayed after the remedy, please contact your dealer or service company.

Troubleshooting

Regarding the indicator lamps (continued)

POWER indicator	LAMP indicator	TEMP indicator	Description
<i>Blinking In Red</i> or <i>Lighting In Red</i>	Turned off	<i>Blinking In Red</i>	The cooling fan is not operating. Please turn the power off, and allow the projector to cool down at least 20 minutes. After the projector has sufficiently cooled down, please make confirmation that no foreign matter has become caught in the fan, etc., and then turn the power on again. If the same indication is displayed after the remedy, please contact your dealer or service company.
<i>Blinking In Red</i> or <i>Lighting In Red</i>	Turned off	<i>Lighting In Red</i>	There is a possibility that the interior portion has become heated. Please turn the power off, and allow the projector to cool down at least 20 minutes. After the projector has sufficiently cooled down, please make confirmation of the following items, and then turn the power on again. <ul style="list-style-type: none"> • Is there blockage of the air passage aperture? • Is the air filter dirty? • Does the peripheral temperature exceed 35°C? If the same indication is displayed after the remedy, please set FAN SPEED of the SERVICE item in the OPTION menu to HIGH.
<i>Lighting In Green</i>	<i>Simultaneous blinking in Red</i>		It is time to clean the air filter. Please immediately turn the power off, and clean or change the air filter referring to the section “Air Filter”. After cleaning or changing the air filter, please be sure to reset the filter timer. After the remedy, reset the power to ON.
<i>Lighting In Green</i>	<i>Alternative blinking in Red</i>		There is a possibility that the interior portion has become overcooled. Please use the unit within the usage temperature parameters (5°C to 35°C). After the treatment, reset the power to ON.
<i>Blinking in Green for approx. 3 seconds</i>	Turned off	Turned off	At least 1 “Power ON” schedule is saved to the projector. (Please refer to the User’s Manual-Network Functions: Schedule Settings for more information.)

NOTE • When the interior portion has become overheated, for safety purposes, the power source is automatically turned off, and the indicator lamps may also be turned off. In such a case, press the “O” (OFF) side of the power switch, and wait at least 45 minutes. After the projector has sufficiently cooled down, please make confirmation of the attachment state of the lamp and lamp door, and then turn the power on again.

Phenomena that may be easy to be mistaken for machine defects

⚠WARNING ▶ Never use the projector if abnormal operations such as smoke, strange odor, excessive sound, damaged casing or elements or cables, penetration of liquids or foreign matter, etc. should occur. In such cases, immediately turn off the power switch and then disconnect the power plug from the power outlet. After making sure that the smoke or odor has stopped, contact your dealer or service company.

1. Before requesting repair, please check in accordance with the following chart. This operation sometimes resolves your problem.

If the situation cannot be corrected,

2. The projector's microprocessor may need to be reset.

Please push the Shutdown switch by using a pin or similar and the projector will be turned off immediately.

Before turning it again, wait at least 10 minutes to make the projector cool down enough.

3. Some setting may be wrong. Please use the FACTORY RESET function of the SERVICE item in the OPTION menu (🔧46) to reset all settings to factory default. Then, if the problem is not removed after the remedy, please contact your dealer or service company.

Phenomenon	Cases not involving a machine defect	Reference page
Power does not come on.	The electrical power cord is not plugged in. Correctly connect the power cord.	12
	The power switch is not set to the on position. Set the power switch to [] (On).	16
	The main power source has been interrupted during operation such as by a power outage (blackout), etc. Please turn the power off, and allow the projector to cool down at least 2 minutes, then turn the power on again.	16
	Either there is no lamp and/or lamp door, or either of these has not been properly fixed. Please turn the power off, and allow the projector to cool down at least 45 minutes. After the projector has sufficiently cooled down, please make confirmation of the attachment state of the lamp and lamp door, and then turn the power on again.	56
Neither sounds nor pictures are outputted.	The signal cables are not correctly connected. Correctly connect the connection cables.	10
	Signal source does not correctly work. Correctly set up the signal source device by referring to the manual of the source device.	—
	The input changeover settings are mismatched. Select the input signal, and correct the settings.	17, 18

Troubleshooting

Phenomena that may be easy to be mistaken for machine defects (continued)

Phenomenon	Cases not involving a machine defect	Reference page
Sound does not come out.	The signal cables are not correctly connected. Correctly connect the audio cables.	10
	The MUTE function is working. Restore the sound pressing the MUTE or VOLUME button on the remote control.	17
	The volume is adjusted to an extremely low level. Adjust the volume to a higher level using the menu function or the remote control.	17
	The AUDIO setting is not correct. Correctly set the items in the AUDIO menu.	37
No pictures are displayed.	The lens cap is attached. Remove the lens cover.	4, 16
	The signal cables are not correctly connected. Correctly connect the connection cables.	10
	The brightness is adjusted to an extremely low level. Adjust BRIGHTNESS to a higher level using the menu function or the remote control.	24, 26
	The computer cannot detect the projector as a plug and play monitor. Make sure that the computer can detect a plug and play monitor using another plug and play monitor.	11
	The BLANK screen is displayed. Press the BLANK button on the remote control.	22
Video screen display freezes.	The FREEZE function is working. Press the FREEZE button to restore the screen to normal.	21
Colors have a faded- out appearance, or Color tone is poor.	Color settings are not correctly adjusted. Perform picture adjustments by changing the COLOR TEMP, COLOR, TINT and/or COLOR SPACE settings, using the menu functions.	25, 27, 31
	COLOR SPACE setting is not suitable. Change the COLOR SPACE setting to AUTO, RGB, SMPTE240, REC709 or REC601.	31

Phenomena that may be easy to be mistaken for machine defects (continued)

Phenomenon	Cases not involving a machine defect	Reference page
Pictures appear dark.	The brightness and/or contrast are adjusted to an extremely low level. Adjust BRIGHTNESS and/or CONTRAST settings to a higher level using the menu function.	24, 25, 26
	The WHISPER function is working. Select NORMAL for the WHISPER item in the SETUP menu.	25, 36
	The lamp is approaching the end of its product lifetime. Replace the lamp.	56, 57
Pictures appear blurry.	Either the focus and/or horizontal phase settings are not properly adjusted. Adjust the focus using the focus ring, and/or H PHASE using the menu function.	19, 30
	The lens is dirty or misty. Clean the lens referring to the section "Caring for the lens".	61
Pictures are trembling.	The exhaust ventilation holes at front is blocked by some objects. Remove any objects from front side of the projector.	4

NOTE • Although bright spots or dark spots may appear on the screen, this is a unique characteristic of liquid crystal displays, and it does not constitute or imply a machine defect.

Specification

Specification

Item	Specification								
Product name	Liquid crystal projector								
Liquid Crystal Panel	Panel size	2.0 cm (0.79 type)							
	Drive system	TFT active matrix							
	Pixels	786,432 pixels (1024 horizontal x 768 vertical)							
Lens	Zoom lens F=1.7 ~ 2.1 f=24 ~ 29 mm								
Lamp	285W UHB								
Speaker	4W x 4								
Power supply	AC 100-120V/5.0A, AC220-240V/2.1A								
Power consumption	460W								
Temperature range	5 ~ 35°C (Operating)								
Size	418 (W) x 139 (H) x 319 (D) mm (Not including protruding parts) * Please refer to the following figure.								
Weight (mass)	7.1 kg								
Ports	<table style="width: 100%; border: none;"> <tr> <td style="vertical-align: top; width: 33%;"> RGB input port RGB1.....D-sub 15pin mini x1 RGB2.....D-sub 15pin mini x1 </td> <td style="vertical-align: top; width: 33%;"> Audio input port AUDIO IN1Stereo mini x1 AUDIO IN2Stereo mini x1 AUDIO IN3 RCA x2 AUDIO IN4 RCA x2 </td> </tr> <tr> <td style="vertical-align: top;"> RGB output port RGB OUT..D-sub 15pin mini x1 </td> <td style="vertical-align: top;"> Communication port CONTROL..... D-sub 9pin x1 </td> </tr> <tr> <td style="vertical-align: top;"> Digital input port M1-D.....M1-D x1 </td> <td style="vertical-align: top;"> Other ports NETWORK.....RJ45 x1 REMOTE CONTROL Stereo mini x1 </td> </tr> <tr> <td style="vertical-align: top;"> Video input port Y, CB/PB, CR/PR..... RCA x3 S-VIDEOS-video x1 VIDEOVideo x1 </td> <td></td> </tr> </table>	RGB input port RGB1.....D-sub 15pin mini x1 RGB2.....D-sub 15pin mini x1	Audio input port AUDIO IN1Stereo mini x1 AUDIO IN2Stereo mini x1 AUDIO IN3 RCA x2 AUDIO IN4 RCA x2	RGB output port RGB OUT..D-sub 15pin mini x1	Communication port CONTROL..... D-sub 9pin x1	Digital input port M1-D.....M1-D x1	Other ports NETWORK.....RJ45 x1 REMOTE CONTROLStereo mini x1	Video input port Y, CB/PB, CR/PR..... RCA x3 S-VIDEOS-video x1 VIDEOVideo x1	
RGB input port RGB1.....D-sub 15pin mini x1 RGB2.....D-sub 15pin mini x1	Audio input port AUDIO IN1Stereo mini x1 AUDIO IN2Stereo mini x1 AUDIO IN3 RCA x2 AUDIO IN4 RCA x2								
RGB output port RGB OUT..D-sub 15pin mini x1	Communication port CONTROL..... D-sub 9pin x1								
Digital input port M1-D.....M1-D x1	Other ports NETWORK.....RJ45 x1 REMOTE CONTROLStereo mini x1								
Video input port Y, CB/PB, CR/PR..... RCA x3 S-VIDEOS-video x1 VIDEOVideo x1									

NOTE • These specifications are subject to change without notice.

Specifications (continued)

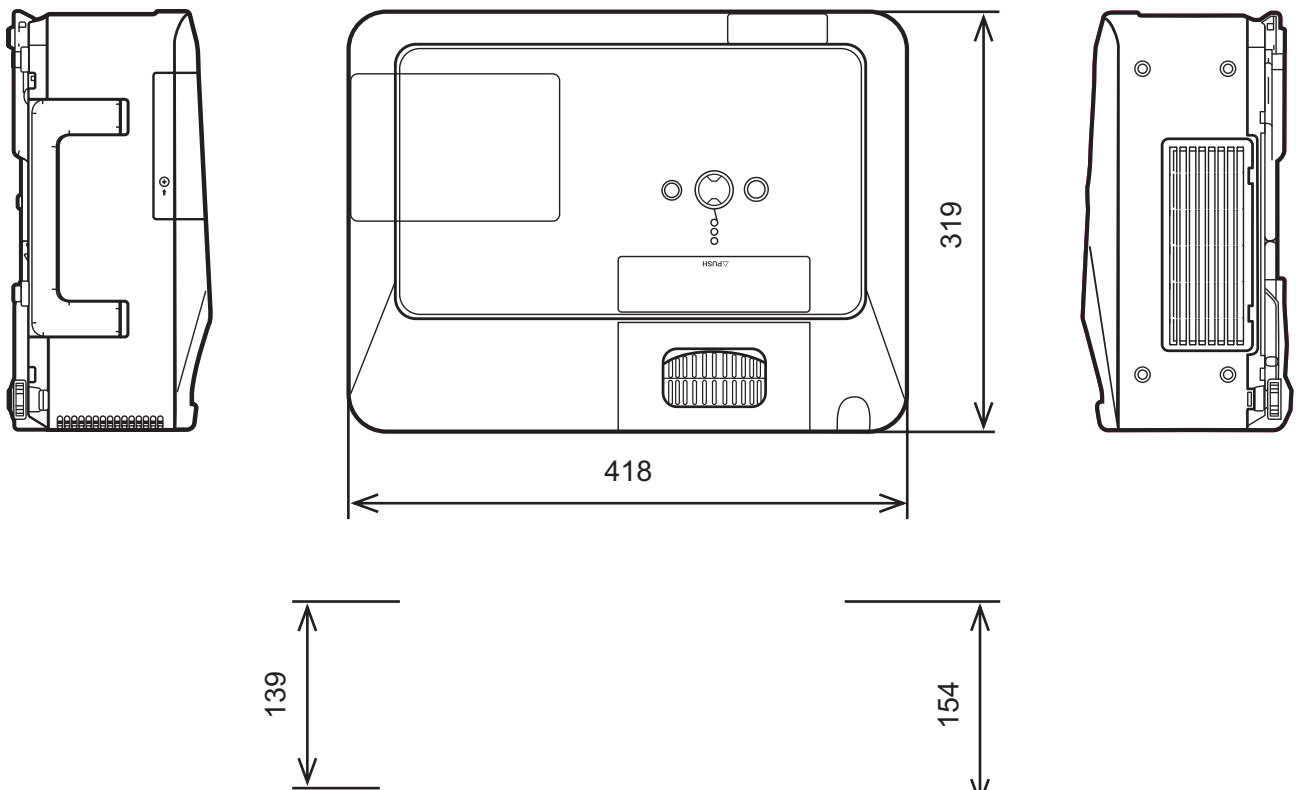

[unit: mm]

Intended Use

Before operating this machine, please read this entire manual thoroughly. The 3M™ Multimedia Projectors are designed, built, and tested for use indoors, using 3M lamps, 3M ceiling mount hardware, and nominal local voltages.

The use of other replacement lamps, outdoor operation, or different voltages has not been tested and could damage the projector peripheral equipment and/or create a potentially unsafe operating condition.

50"Owmk o g fkc"rtqlgevqtu'cpf"Ycm'Fkurnc{ "U{uvg o u'ctg"fguk i pg f"vq"qrgtcvg"kp"c"pqt o ca"qhLeg"gpixtqp o gpv0

- 16° to 29°C (60° to 85° F)
- 10- 80 %RH (without condensation)
- 0- 1828 m (0-6000 feet) above sea level

The ambient operating environment should be free of airborne smoke, grease, oil and other contaminants that can affect the operation or performance of the projector.

Use of this product in adverse conditions will void the product warranty.

Let us help you make the most of your next presentation. We offer everything from presentation supplies to tips for better meetings. And we're the only transparency manufacturer that offers a recycling program for your used transparencies. For late-breaking news, handy reference and free product samples, call us toll-free in the continental United States and Canada, 24 hours a day, or visit our Internet Website.

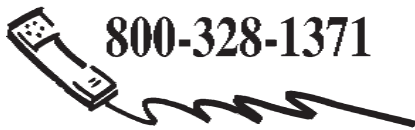

<http://www.3m.com/meetings>
e-mail: meetings@mmm.com

3M Austin Center
Building A145-5N-01
6801 River Place Blvd.
Austin, TX 78726-9000

3M Canada
P.O. Box 5757
London, Ontario
N6A 4T1

3M Mexico, S.A. de C.V.
Apartado Postal 14-139
Mexico, D.F. 07000
Mexico

3M Europe
Boulevard de l'Oise
95006 Cergy Pontoise Cedex
France

Litho in Japan
© 3M 2007
78-6970-9492-4 Rev. A