

ZR500

Power Amplifier

# CARVER

P R O F E S S I O N A L



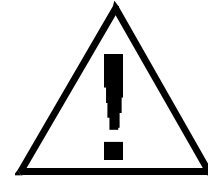
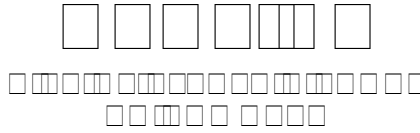
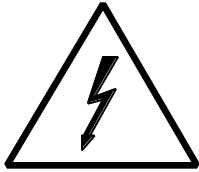

**CAUTION: TO REDUCE THE RISK OF ELECTRIC SHOCK, DO NOT REMOVE THE COVER. NO USER SERVICEABLE PARTS INSIDE. REFER SERVICING TO QUALIFIED PERSONNEL!**

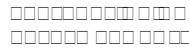

The exclamation point within an equilateral triangle is intended to alert the user of the presence of important operating and maintenance (servicing) instructions in the literature accompanying the appliance.



The lightning flash with the arrowhead symbol within an equilateral triangle is intended to alert the user to the presence of uninsulated "dangerous voltage" within the products' enclosure that may be of sufficient magnitude to constitute a risk of electric shock to persons.



- 1) Read these instructions.
- 2) Keep these instructions.
- 3) Heed all warnings.
- 4) Follow all instructions.
- 5) Do not use this apparatus in or near water.
- 6) Clean only with a dry cloth.
- 7) Do not block any ventilation openings. Install in accordance with the manufacturer's instructions.
- 8) Do not install near any heat sources such as radiators, heat registers, stoves, or other apparatus that produce heat.
- 9) Do not defeat the safety purpose of the polarized or grounding-type plug. A polarized plug has two blades with one wider than the other. A grounding-type plug has two blades and a third grounding prong. The wide blade or the third prong is provided for your safety. If the provided plug does not fit into your outlet, consult an electrician for replacement of the obsolete outlet.
- 10) Protect the power cord from being walked on or pinched, particularly at plugs, convenience receptacles, and the point where they exit from the apparatus.
- 11) Only use attachments/accessories specified by the manufacturer.
- 12) Unplug this apparatus during lightning storms or when unused for long periods of time.
- 13) Refer all servicing to qualified service personnel. Servicing is required when the apparatus has been damaged in any way, such as power supply cord or plug is damaged, liquid has been spilled or objects have fallen into the apparatus, the apparatus has been exposed to rain or moisture, does not operate normally or has been dropped.

TO REDUCE THE RISK OF FIRE OR ELECTRIC SHOCK, DO NOT EXPOSE THIS APPARATUS TO RAIN OR MOISTURE.

TO PREVENT ELECTRIC SHOCK DO NOT REMOVE TOP OR BOTTOM COVERS.  
NO USER SERVICEABLE PARTS INSIDE. REFER SERVICING TO QUALIFIED SERVICE PERSONNEL.

**FCC COMPLIANCE NOTICE:** This device complies with part 15 of the FCC rules. Operation is subject to the following two conditions: (1) This device may not cause harmful interference, and (2) this device must accept any interference received, including interference that may cause undesired operation.

**CAUTION:** Changes or modifications not expressly approved by the party responsible for compliance could void the user's authority to operate the equipment.

**NOTE:** This equipment has been tested and found to comply with the limits for a Class B digital device, pursuant to part 15 of the FCC Rules. These limits are designed to provide reasonable protection against harmful interference in a residential installation. This equipment generates, uses, and can radiate radio frequency energy and, if not installed and used in accordance with the instruction manual, may cause harmful interference to radio communications. However, there is no guarantee that interference will not occur in a particular installation. If this equipment does cause harmful interference to radio or television reception, which can be determined by turning the equipment off and on, the user is encouraged to try to correct the interference by one or more of the following measures:

- Reorient or relocate the receiving antenna.
- Increase the separation between the equipment and receiver.
- Connect the equipment into an outlet on a circuit different from that to which the receiver is connected.

**IMPORTANT:** ZR Series amplifiers require Class 2 output wiring.

**MAGNETIC FIELD**

**CAUTION!** Do not locate sensitive high-gain equipment such as preamplifiers or tape decks directly above or below the unit. Because this amplifier has a high power density, it has a strong magnetic field, which can induce hum into unshielded devices that are located nearby. The field is strongest just above and below the unit. If an equipment rack is used, we recommend locating the amplifier(s) in the bottom of the rack and the preamplifier or other sensitive equipment at the top.



<b>SAFETY INSTRUCTIONS</b> .....	2
Magnetic Field Warning .....	2
FCC Compliance Notice .....	2
<b>INTRODUCTION</b> .....	4
Unpacking .....	4
Important Paperwork .....	4
<b>POWER SPECIFICATIONS</b> .....	4
<b>FEATURES</b> .....	4
<b>SPECIFICATIONS</b> .....	5
<b>EXTERNAL CHASSIS DIMENSIONS</b> .....	5
<b>EXTERNAL CONTROLS, CONNECTORS, AND STATUS INDICATORS</b> .....	6
Front Panel .....	6
Rear Panel .....	7
<b>INTERNAL JUMPER SETTINGS</b> .....	8
Input Polarity .....	8
Input Sensitivity .....	8
<b>INSTALLATION AND CONNECTIONS</b> .....	9
Mounting .....	9
Temperature/Humidity Considerations .....	9
AC Power .....	9
Input Configuration .....	9
Balanced and Unbalanced Connections .....	9
Output Configuration .....	10
Sequencing .....	10
<b>WARRANTY INFORMATION</b> .....	11
<b>CARE AND SERVICE ASSISTANCE</b> .....	11
<b>IN CASE OF DIFFICULTY</b> .....	12



*Congratulations on choosing the Carver Professional ZR Series Amplifier! The ZR Series amplifiers not only have superior fidelity and the capability to drive low impedances, they are among the most efficient professional power amplifiers on the market. By utilizing digital power processing (DPP®), our ZR series can deliver generous power levels, even at 2 Ohm stereo loads. By design, the ZR Series power amplifiers are very accurate and efficient. Your ZR Series amplifier should give you many years of outstanding service and reliability.*

**UNPACKING**

Inside the box you will find; one ZR Series Amplifier, one IEC-type power cord, two Euro-style input connectors, four self-adhesive rubber feet, and an owner's manual and warranty card.

Carefully unpack the amplifier and keep the original carton and packing materials for future moving, shipment or long-term storage. After opening the box, please check for visible signs of damage that were not apparent from the outside of the box. If you encounter what appears to be concealed damage, please consult your Carver Professional Dealer before installing unit.

**IMPORTANT PAPERWORK**

Make sure to save your sales receipt. Your receipt is extremely important to establish the duration of your Limited Warranty and for insurance purposes. Next, make a note of the serial number, which is located on the back of the amplifier. Record it in the space provided below for convenient reference.

Serial Number: \_\_\_\_\_ Purchased at: \_\_\_\_\_ Date: \_\_\_\_\_

Finally, take a moment to fill out the **Warranty Registration Card** packed with the amplifier and return it to Carver Professional. This will allow us to keep you informed about new products as they become available.

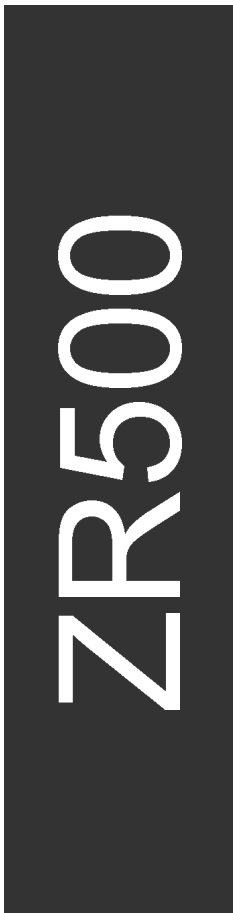

**POWER SPECIFICATIONS**

- 95W per channel into 8 ohm stereo loads, 20 Hz to 20 kHz, with less than 0.5% THD+N
- 150W per channel into 4 ohm stereo loads, 20 Hz to 20 kHz, with less than 0.5% THD+N
- 250W per channel into 2 ohm stereo loads, 1 kHz, with less than 0.5% THD+N
- 300W bridged mono into 8 ohms, 20 Hz to 20 kHz with less than 0.5% THD+N
- 500W bridged mono into 4 ohms, 1 kHz with less than 0.5% THD+N

**FEATURES**

- High Efficiency Spread Spectrum Switching Amplifier
- Stable 2 Ohm Operation
- Variable Speed, Ultra-quiet Fan Cooling
- 4 LED Level Display, Per Channel, Including Signal Present and Clip Indicators
- 3 LED Status Display: Ready, Protect and Thermal Overload
- Standby LED Indicates the Amplifier is in Standby Mode
- Level Control Defeat Accessible From Front Panel
- Switched 40 Hz/80 Hz (12 dB/Octave Cut) High Pass Filters
- Switched Soft Knee Clip Limiters
- Soft Start In-Rush Current Limiting
- Individual Ground Lifts for Each Channel Input
- Terminals for Sequencing Power (On/Off)
- Input via Neutrik® Combo Connectors and Euro-style Connectors
- Speaker Outputs via 3 Neutrik® Speakon® Connectors
- Power Switch, 3 Positions: ON, OFF, Standby
- AC Line Cord (Detachable IEC Type)

DPP® is a registered trademark of Tripath Technology, Inc.  
 Speakon® is a registered trademark of Neutrik, Inc.  
 Neutrik® is a registered trademark of Neutrik, Inc.



## PERFORMANCE

THD+N (both channels driven):	<0.5% @ rated power (4 ohm), 20-20kHz, 20kHz BW <0.15% @ rated power (4 ohm), 1kHz
IMD (SMPTE):	<0.06% @ -10dB referenced to rated power (4 ohm), 1kHz <0.2%, 60Hz/7kHz, 4:1, 35Vpeak @ 4 ohms
Dynamic Headroom:	1.5dB
Power Bandwidth:	20-20 kHz @ 4 and 8 ohm loads
Frequency Response:	20-20kHz, +0dB/-1dB
Signal-to-Noise:	100dB, A-Weighted, referenced to 4 ohm rated power, 22kHz BW
Crosstalk:	-70dB @1kHz referenced to rated power (4 ohm)
CMRR:	70dB at 1kHz
Slew Rate:	7V/Sec
Sensitivity for rated power:	0.316Vrms
(Variable settings via jumpers)	0.775Vrms (Factory Preset) 1.23Vrms 2.45Vrms
Input Impedance:	50k balanced
Input Overload:	20dBu
Protection:	Thermal, Short Circuit, Over-current & Over Voltage, Self-resetting
Stability:	Unconditionally Stable Into Reactive Loads
Duty Cycle:	Continuous operation at 1/3rd power

## POWER REQUIREMENTS:

Mains Voltage:	100VAC (50-60Hz) ±10%
(output power rated at nominal voltage)	117VAC (60Hz) ±10%
	234VAC (50Hz) ±10%
Maximum consumption @ rated power (4 ohm):	
1kHz sine wave	117VAC (60Hz)      440W/4.8Arms
	234VAC (50Hz)      442W/2.4Arms

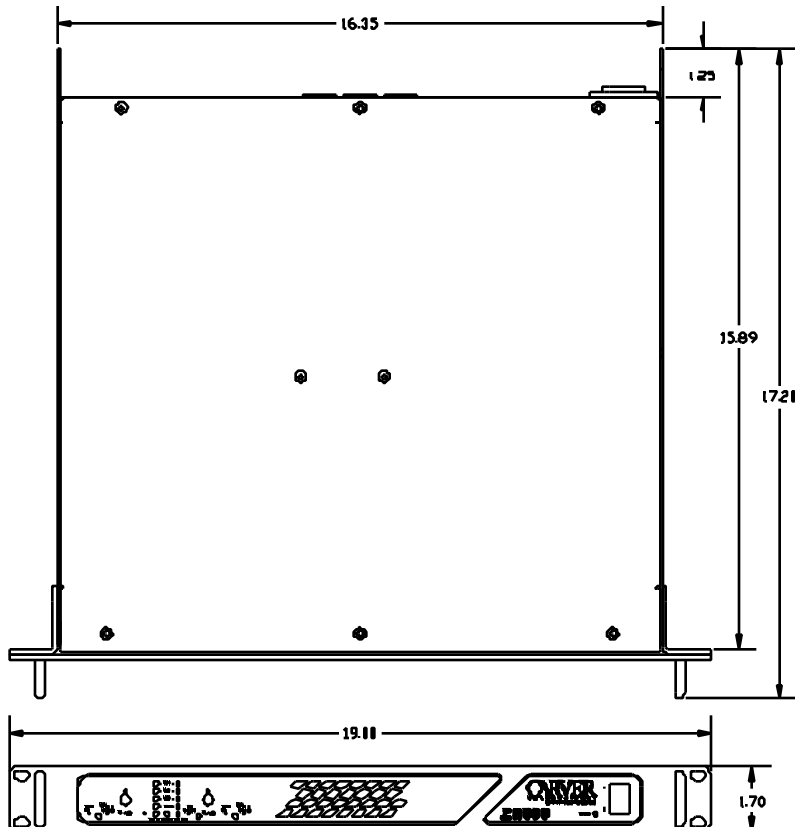

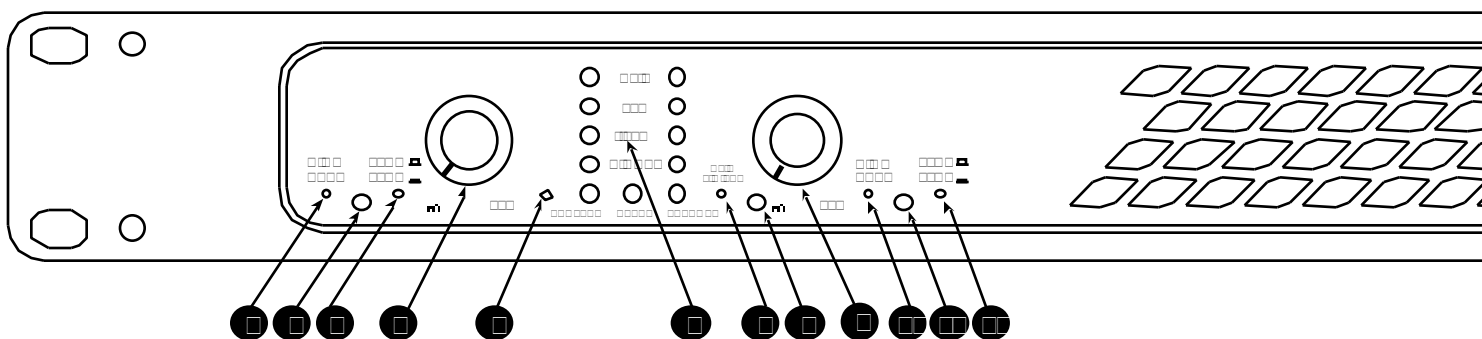

### 1 & 10 – HIGH PASS FILTER SWITCHES

Separate switches on each channel to enable highpass filters. Highpass filters cut off the lowest frequencies to eliminate rumble and prevent excess speaker excursion. The filter is enabled when the switch is pushed in.

### 2 & 11 – HIGH PASS FILTER STATUS LEDs

Separate indicators on each channel illustrate the highpass filter status. The LED is dark when the filter is not engaged. A Red color indicates the cutoff is set at 40Hz, green indicates the cutoff is set at 80Hz.

### 3 & 12 – HIGH PASS FILTER CUTOFF FREQUENCY SELECTOR SWITCHES

Separate switches for each channel select the highpass filter cutoff frequency. When the switches are out, the cutoff is set at 40Hz. When the switches are in, the cutoff is set at 80Hz.

### 5 – LEVEL CONTROL DEFEAT

When the switch is in, the level controls are set to 0dB attenuation no matter what the position of the knobs.

### 4 & 9 – LEVEL CONTROLS

Sets the amount of signal attenuation, down to a maximum of -100dB.

### 6 – SIGNAL LEVEL AND DIAGNOSTIC LEDs

An array of indicators that show the operational status of the amplifier and the signal level.

**PROTECT:** Whenever a very low impedance (short circuit) is detected on either of the outputs, or an over voltage, under voltage or over current situation is detected the amplifier will protect itself and connected loads by immediately ceasing to drive the output stage.

**READY:** The amplifier is operational.

**THERMAL:** Whenever the output section and/or the power transformer exceeds preset thermal limits, the amp is disabled and will resume once it has cooled.

**SIGNAL:** Indicates a signal is detected at the input.

**-6dB:** Indicates the output has reached a level 6dB below rated power.

**0dB:** Indicates the amplifier is producing full output (or slightly below, depending on load impedance).

**CLIP:** Indicates the output signal is reaching approximately 1% distortion.

### 7 – CLIP LIMITER SWITCH

When the switch is in the clip limiter is enabled.

### 8 – CLIP LIMITER STATUS LED

Indicates when the clip limiter is enabled.

### 13 – STANDBY LED

Indicates that the amp is in Standby mode. When in Standby mode, the amplifier is turned “OFF”, but the AC Mains are connected and the amplifier waits for a DC voltage at the Sequence connector on the rear of the amp. Once a DC voltage is applied to the Sequence connector, the amp turns “ON” and begins its start-up diagnostics and upon completion is ready for use.

### 14 – POWER SWITCH

A three-position switch used to select the power operation mode. In the center position, power is off. In the up position, power is on. In the down position, amp is set to standby mode.

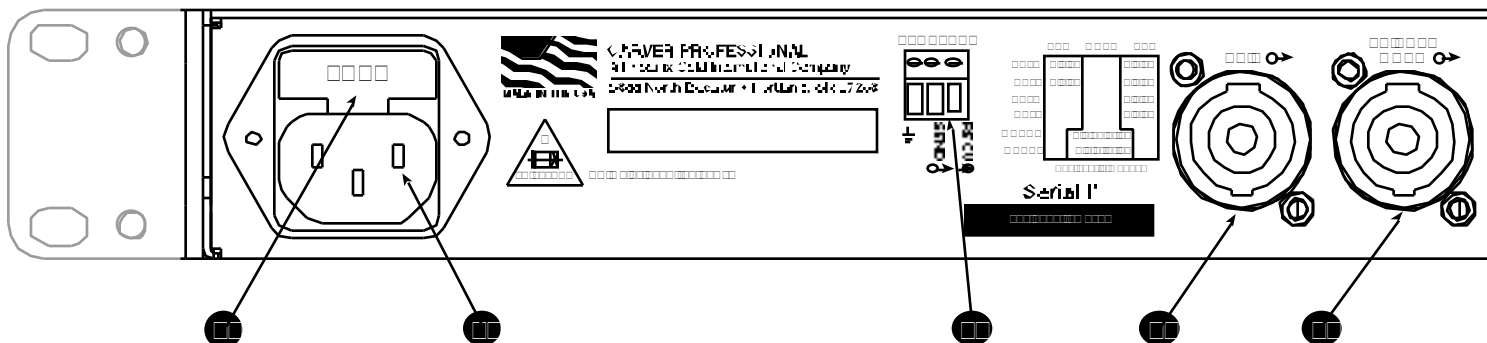

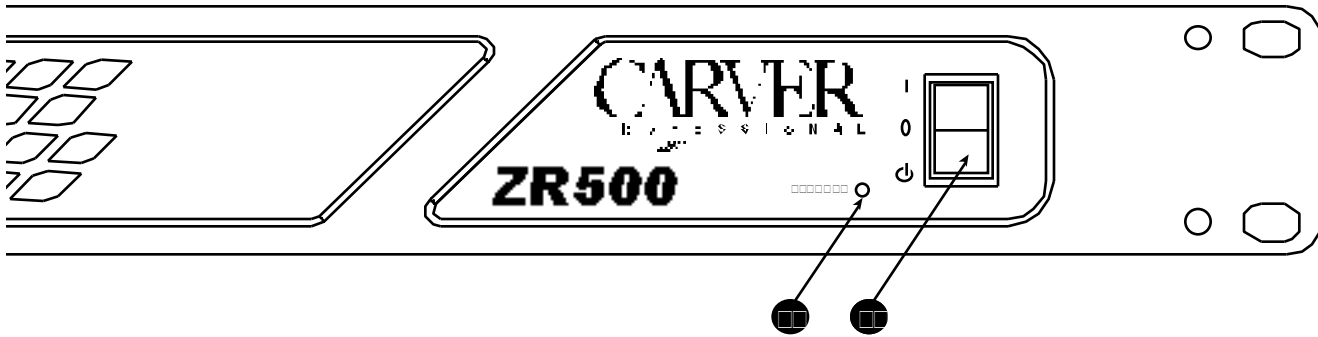

**15 – FUSE CARRIER**

Holds the AC mains fuse and has a storage location for a spare fuse. (not provided)

**16 – AC MAINS CONNECTOR**

IEC type power cord attaches here.

**17 – SEQUENCE CONNECTOR**

Used for sequencing power to multiple amps. (See page 9)

**18, 19 & 20 – SPEAKER OUTPUTS**

A set of three, 4-conductor Neutrik® Speakon®NL4 connectors to connect the amplifier to the speakers.

18 - CHANNEL TWO provides the output of channel two only, on pins 1+/1-.

19 - BRIDGED MONO uses the output of both channels to create a single channel with twice the power. The output is provided on both pins 1+/1- and 2+/2- of the Speakon®, allowing the use of all four conductors to lower the cable resistance. This output should only be used when the Mono switch is enabled.

20 - CHANNEL ONE actually provides output for channel one AND channel two using a single 4-conductor cable. Channel one output is present on pins 1+/1- of the Speakon®, and channel two output is present on pins 2+/2-.

**21 & 30 – BALANCED AUDIO INPUTS**

Neutrik® Combo connectors which accept male XLR, TS and TRS 1/4" phone plugs. By default, XLR pin 2 is hot and Tip is hot. Polarity of the XLR can be reversed with jumper settings inside the amp. (See page 7)

**22 & 39 – BALANCED AUDIO INPUTS**

Euro-type connectors used for balanced or unbalanced signals.

**23 & 28 – GROUND LIFT SWITCHES**

Separate switches for each channel that disconnects ground pin of the input connectors from chassis ground. Used to eliminate ground loop conditions that cause hum. When the switch is in the ground is lifted.

**24 & 27 – GROUND LIFT STATUS LEDS**

These are separate indicators for each channel which light up when the Ground Lift switches are enabled.

**25 – MONO SWITCH**

When the switch is "in," the amp is set to Mono mode. Mono operation causes the signal connected to the channel Two input to drive both channels. The channel One input is disabled in Mono mode.

**26 – MONO STATUS LED**

This indicator will light when the Mono switch is engaged.

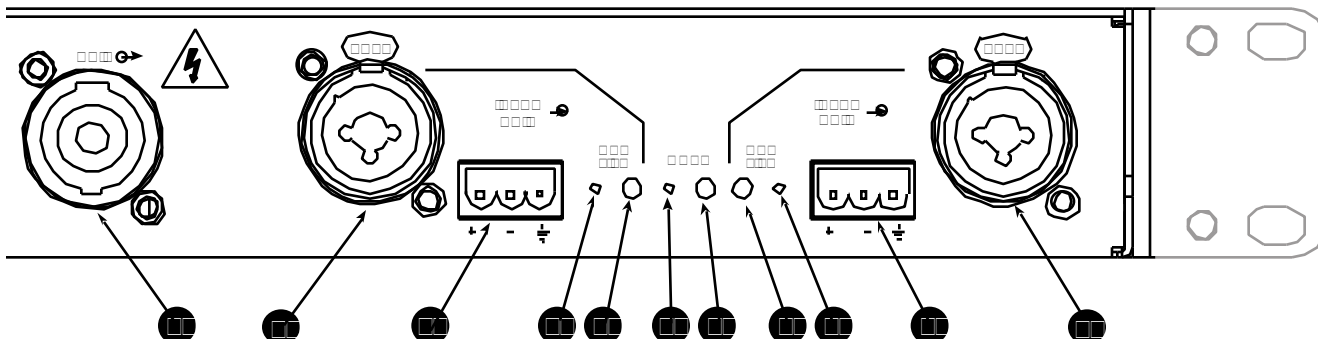



**NOTE:** Resetting any of the jumpers on the input card requires that you remove the top cover. This operation should be performed by a qualified technician only! Always disconnect the AC Mains when performing this operation.

To access the internal jumpers, remove the top cover of the amplifier. Locate the input board as shown below.

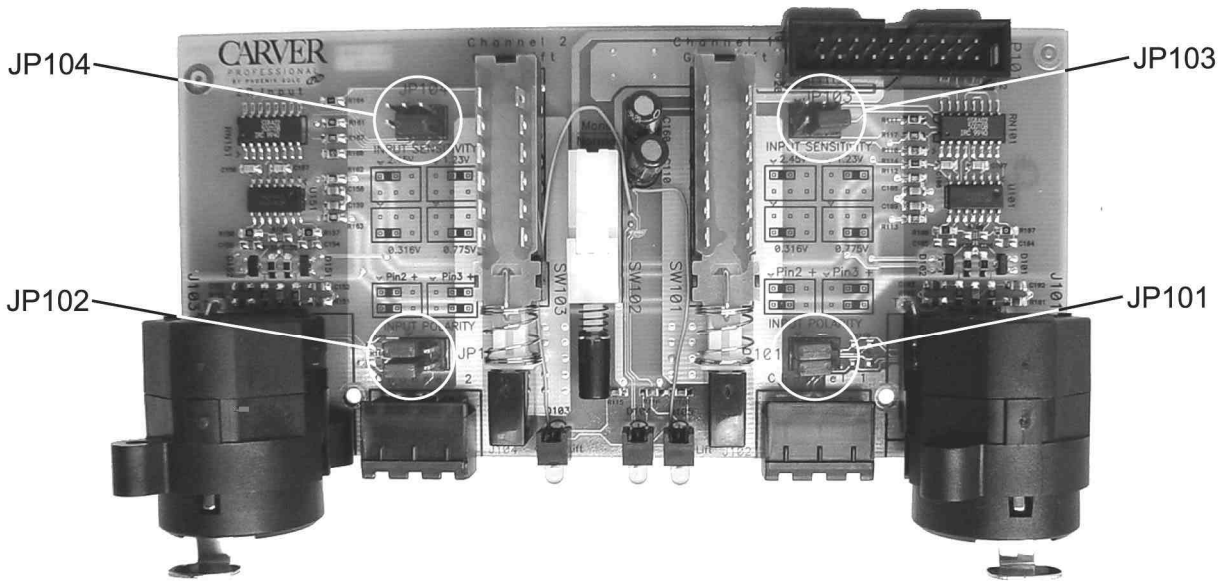

### INPUT POLARITY

JP101 and JP102 are 6 pin headers that are used to change the polarity of the balanced input jacks. By default, pin 2 is hot. Changing both jumpers to the opposite position will make pin 3 hot on that channel. **NOTE: Both jumpers on either header MUST be on the same side.**

The illustration below shows how the jumpers are configured to set either Pin 2 or Pin 3 as the "positive" or "hot" pin on the XLR connector.

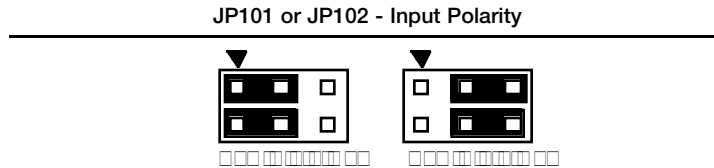

### INPUT SENSITIVITY

JP103 and JP104 are 6 pin headers that are used to adjust the amplifier's input sensitivity for a wide variety of source levels. Each channel can be set to any one of four positions: **NOTE: With no jumper connected, the input sensitivity defaults to 0.775Vrms.**

- 0.316Vrms / -10dBV = Full Output  
(Commonly seen in consumer devices with low voltage unbalanced outputs)
- 0.775Vrms / 0dBu = Full Output  
(Most common line-level calibration)
- 1.23Vrms / +4dBu = Full Output  
(Commonly seen in professional audio products with balanced outputs)
- 2.45Vrms / +10dBu = Full Output  
(Devices with large voltage swing, used to drive long line-level paths)

See the illustration below to configure a specific input sensitivity. The Photo above will show the location of the jumpers on the input board.







## MOUNTING

Before you begin, make sure your amplifier is disconnected from the power source, with power switch in the “off” position and all level controls turned completely down (counter-clockwise).

Mount in a standard 19-inch (48.3 cm) equipment rack.

**NOTE:** When transporting amplifiers in a rack, it is recommended to use the rear rack supports.

## ENSURE PROPER COOLING

Do not block rear or side intake slots or front exhaust vent.

## TEMPERATURE & HUMIDITY CONSIDERATIONS

Normal operation is expected from -20C to +40C ambient at 1/3 rated power into 4 ohms with humidity non-condensing.

## AC POWER

Connect the supplied AC mains cord to the IEC socket on the rear panel and to the AC mains, appropriate for your amplifier, to provide power to the amplifier.

## INPUT CONFIGURATION *(see figure below)*

ZR series amplifiers can be operated in stereo, dual-mono and bridged mono. Input connections are handled via Neutrik® Combo connectors as well as Euro-style connectors. Fully balanced input connections can be configured for pin 2 hot or pin 3 hot. Ground lift switches are provided for each channel to remove shield ground from chassis ground. Input sensitivity can be internally configured to any of four industry standard levels (see page 7). In stereo mode, a separate signal is required for each channel. In dual-mono and bridged mono, a single signal is connected into the channel 2 input. The input board supports connections via XLR, 1/4 inch TRS or TS phone plugs and Euro-style connectors.

Input Connectors

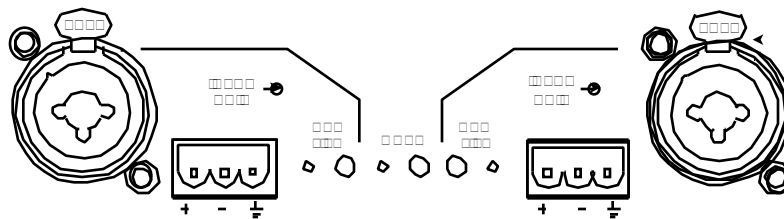

## BALANCED & UNBALANCED CONNECTIONS

The inputs are designed to handle balanced or unbalanced signals. When using unbalanced signals, it is recommended that the cable be shielded two-conductor with the shield tied to ground at the source. If shielded single conductor cable must be used, tie the shield to ground at both the source and amplifier.

input. In most cases, equipment that has unbalanced outputs will have lower signal level. In these cases, adjust the amplifier’s gain using the internal jumper settings as described on page 7. Long runs of unbalanced signals are prone to loss, noise and hum. Use balanced signals whenever possible.

Unbalanced Connections

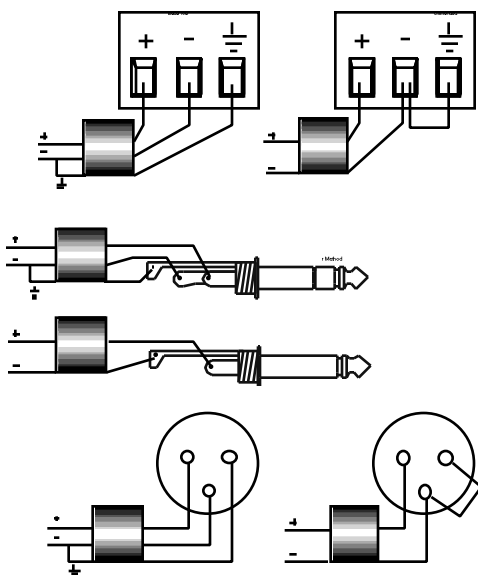

Balanced Connections

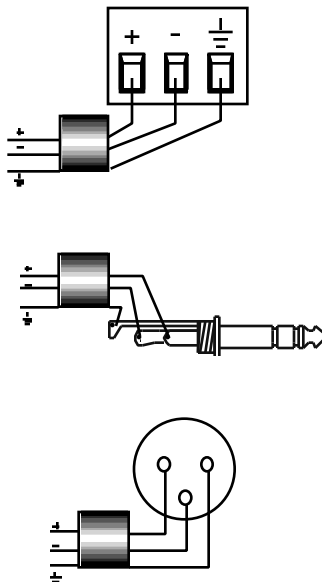

Equivalent Input Schematic - ZR500 Amplifier  
*(Polarity and gain jumpers omitted for clarity.)*

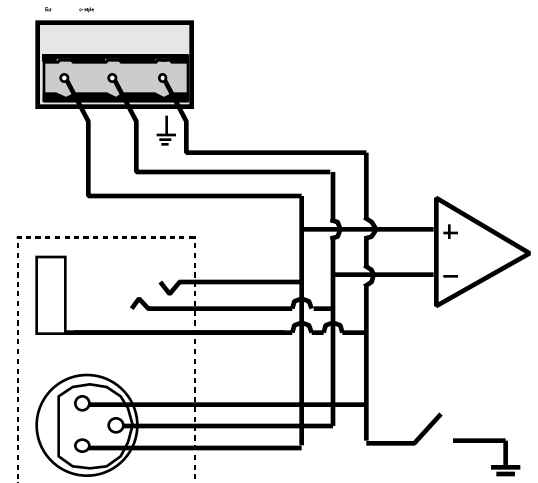



## OUTPUT CONFIGURATION

Output connections are handled via 3 female Neutrik® Speakon® NL4 connectors. In stereo or dual-mono mode, both channels can be connected via a single four conductor cable using the Speakon® NL4 in the channel 1 output jack. Channel 1 is connected at Pin1+ and Pin1-, and Channel 2 at Pin2+ and Pin 2-.

The bridged mono Speakon® jack provides the bridged output on Pin1+ and Pin1-, or at Pin 2+ and Pin 2-. This allows a connection to match any loudspeaker configuration.

The channel 2 Speakon® output provides channel 2 output at Pin 1+ and Pin 1- in both stereo and dual-mono mode.

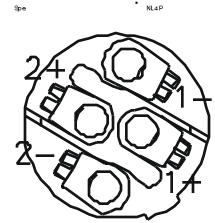
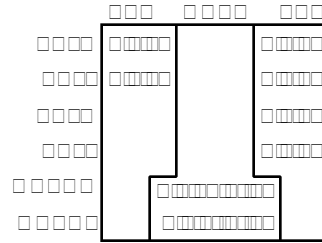
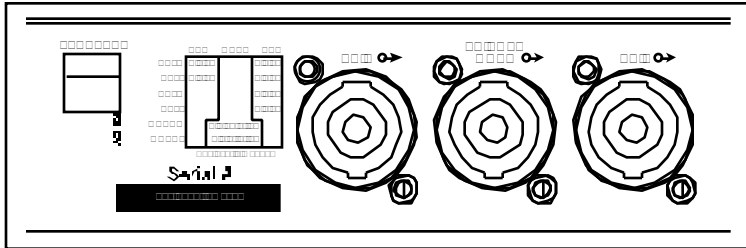

As Illustrated in the Figures Above:

### Channel 2 Speakon® Connector

Channel 2 (+) is connected at Pin 1+  
Channel 2 (-) is connected at Pin 1-

### Bridged Mono Speakon® Connector

Positive or Non-Inverted Mono output is connected at Pin 1+  
Negative or Inverted Mono output is connected at Pin 1-  
Positive or Non-Inverted Mono output may also be connected at Pin 2+  
Negative or Inverted Mono output may also be connected at Pin 2-

### Channel 1 Speakon® Connector

Channel 1 (+) is connected at Pin1+  
Channel 1 (-) is connected at Pin 1-  
Channel 2 (+) may be connected at Pin 2+  
Channel 2 (-) may be connected at Pin 2-



**CAUTION:** To avoid damaging the equipment, DO NOT ground any output terminal of the ZR amplifier.

## SEQUENCING

For multi-amplifier installations, the sequencing feature limits the overall inrush current by delaying power up of each amplifier in the sequence by 1/2 second.

For locally sequenced power up, the power switch on the first amplifier in the chain will act as the master switch. To power up the entire rack of amplifiers, you simply turn on the power switch of the first amplifier. The power switch of the first amplifier should never be set to "Standby". All the other amplifiers in the chain must be set to "Standby," so they can receive the power-on command from the first amplifier. Locate the Euro-style connector labeled "Sequence" on the rear panel. Connect a single conductor from the "SEND," terminal of the first amplifier to the "RECV" terminal of the second amplifier in the sequence. Connect the "SEND" terminal of the second amplifier to the "RECV" terminal of the third amplifier. Repeat until you reach the end of the chain.

**NOTE:** The last amplifier in the series will not have any connections at the "SEND" terminal and all sequence ground terminals are connected either by a 16 gauge stranded conductor (minimum) or via the common chassis ground provide by a rack rail if rack mounted. Measuring from the sequence ground to a point on the rack rail there should be no more than 0.5 ohm DC resistance if the sequence grounds are not directly connected to each other.

For remote sequenced power up, the power switch on all amplifiers must be set to the "Standby" position. Apply a fused external 5 - 15Vdc (greater than or equal to 20mA) supply voltage to the "RECV" terminal via a switch and the " " terminal. Connect the "SEND" terminal to the next amplifier's "RECV" terminal as referenced above for a "local sequence power up".

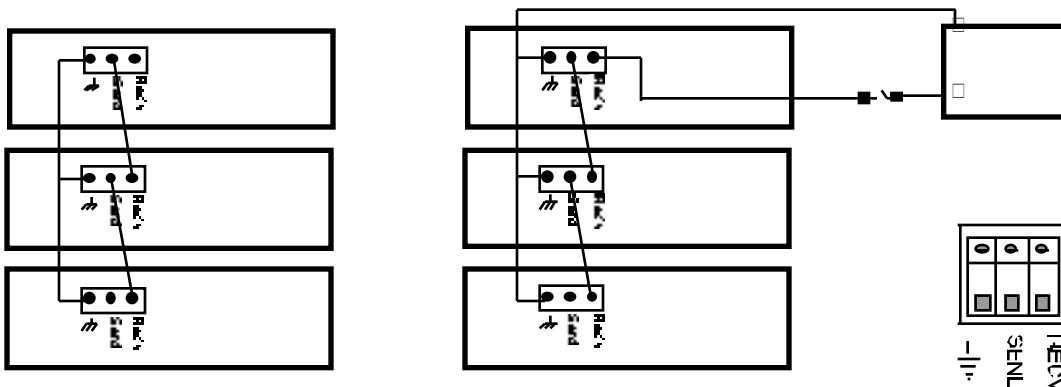



**ZR SERIES POWER AMPLIFIERS: 5 YEARS\***  
**ZR SERIES MODULES AND ACCESSORIES: 1 YEAR**

\* NOTE: The following warranty is exclusive to the United States and its possessions and territories. In all other countries the warranty period is limited to two years. Please see your Carver Professional dealer or distributor for the correct warranty information in your area or locale.

**WHAT IS COVERED**

THIS LIMITED WARRANTY COVERS DEFECTS IN MATERIAL AND WORKMANSHIP ONLY. This limited Warranty DOES NOT extend to: 1) damage caused by shipment, 2) damage caused by accident, misuse, abuse, failure to perform owner maintenance, or operation contrary to the instructions in the Carver Professional owner's manual, 3) units on which the serial number has been defaced, modified or removed and 4) damage resulting from modification or attempted repair by any other person than authorized by Carver Professional.

**WHAT WE WILL PAY FOR**

Carver Professional will pay all labor and material expenses for items covered under this Limited Warranty. See the next section concerning shipping charges.

**TO OBTAIN WARRANTY SERVICE**

In the event your Carver Professional product requires service, contact your Carver Professional Authorized Dealer / Contractor or contact Carver Professional (ATTN: Customer Service Dept.) 9300 North Decatur, Portland, OR 97203, or call Customer Service Department directly at (503) 978-3343. You will be directed to an Authorized Carver Professional Service Station or receive instructions to ship the unit to the factory. Please save the original carton and packing materials in case shipping is required. Please do not ship parcel post. Include a complete description of the problem, the associated components and connections, and a copy of the purchase receipt. Carver Professional does not pay initial shipping costs. Return shipping costs will be pre-paid if repairs were covered by the scope of this warranty.

**KEEP SALES RECEIPT**

To obtain coverage under this limited warranty, you must retain and provide your sales receipt. The warranty period begins from the date of the first consumer purchase from an Authorized Carver Professional Dealer. Any implied warranties for merchantability and fitness for a particular purpose required by any state law are limited in duration to the warranty period of your product. The warranty set forth above is exclusive and no other, written or oral is expressed or implied. Carver Professional specifically disclaims the implied warranties and merchantability and fitness for a particular purpose.

**EXCLUSIONS**

In no event shall Carver Professional be liable for property damage, or any other incidental or consequential damages,

which may result from failure of this product. If your Carver Professional product proves defective in material or workmanship, the liability of Carver Professional shall be limited to the repair or replacement, at the option of Carver Professional, of any defective part.

**STATE LAWS MAY DIFFER**

Some states do not allow limitations on how long an implied warranty lasts and/or do not allow the exclusion or limitation of incidental or consequential damages, so the above limitations may not apply to you. This warranty gives you specific legal rights, and you may have other rights, which vary, from state to state.

**OTHER IMPORTANT PROVISIONS**

Carver Professional reserves the right to make changes in design and improvements to its products without the responsibility of installing such changes or improvements on products previously sold by Carver Professional. We suggest that you attach your purchase receipt to this Warranty and keep both documents in a safe place. Thank you for your choice of a Carver Professional Amplifier.



**CARE**

Wipe off the ZR Series Amplifier's front panel and chassis from time to time, with a soft, dry cloth. If you have something stubborn to remove, use a mild dish soap or detergent sparingly applied to a soft cloth. Don't use alcohol, ammonia or other strong solvents.

**SERVICE ASSISTANCE**

We suggest that you read the Limited Warranty completely to fully understand your warranty/service coverage. Please promptly complete and return the Warranty registration card. Also, be sure to save the sales receipt in a safe place. It will be necessary for warranty service. If your Carver Professional product should require service, you may contact the Carver Professional Technical Service Department by calling (503) 978-3343 or by writing to us at the Factory address found on page 11. We will then direct you to the nearest in our national network of Authorized Warranty Service Centers, or give you detailed instructions on how to return the product to us for prompt action. If you should have questions or comments, please write to the Factory address shown on page 11, or contact us via email at support@carverpro.com or at our web site: www.carverpro.com. Please include the model and serial number of your Carver Professional product, your complete address and daytime phone number.



If you are having trouble, or suspect a problem with your ZR Series amplifier, try some simple troubleshooting before contacting an Authorized Carver Professional Dealer, Authorized Carver Professional Service Center or Carver Professional Technical Service. Below are listed some general problems and items that should be checked in an attempt to resolve the difficulty

### NO SOUND, NO POWER

This is usually an indication of a power supply problem in either the power line itself or the amplifier's power supply. Check the following:

- 1) ZR Series amplifier's power is switched off.
- 2) Line cord is disconnected.
- 3) Poor fit between the plug and AC receptacle.
- 4) Power off at AC receptacle (check with tester or lamp).
- 5) The amplifier is plugged into a switched outlet. Verify that the outlet is live.
- 6) ZR Series amplifier's mains fuse has blown. This amplifier contains no user serviceable fuses inside the chassis.

### POWER ON, LOW OUTPUT OR NO OUTPUT

Low or no output problems are usually signal-source, bad cable or partial output short circuit related.

- 1) The input level sensitivity controls are set too low.
- 2) Move the input connection to another amplifier that you know is working to verify that it is not a source problem.
- 3) Check speaker connections. Be sure that there are no small strands of wire touching similar strands coming from the other wire in the cable.
- 4) Make sure the speakers are functioning correctly.
- 5) If you are using bridged-mono mode, ensure that the Input and Output configurations are set correctly.
- 6) Use a voltmeter to determine if the power line voltage is dropping excessively when the amplifier is driven hard.

- 7) The thermal breaker in the power transformer has opened. Allow amplifier to cool and the breaker will reset itself.

### PLAYBACK IS MIXED WITH HUM

- 1) Check or replace the connecting cables, between source and amplifier's input.
- 2) Make sure that each screw terminal connection is tight.
- 3) Signal cables may have been routed too closely to the AC cables, power transformers, motors or EMI inducing device.
- 4) Try connecting another source to the power amplifier inputs. If the hum stops, the problem lies with the original source component.

### DISTORTION

Distortion is usually caused by excessive loss in the input controls (the mixer/equalizer/crossover cannot produce enough output), overdriving resulting in output clipping, or current limiting caused by excessively low load impedance.

- 1) Check the setting of the input level sensitivity controls. If set too high, the preceding piece of equipment may overdrive the input stage.
- 2) Check the speaker connections and verify that all screw connections are tight and that there are no stray strands of wire to cause short circuits.
- 3) Verify that the total load impedance presented to the amplifier is within the limits described in this manual for mode of operation selected.



#### MAIL TO:

#### Carver Professional

Service Department OR Customer Support  
9300 North Decatur  
Portland, Oregon 97203

#### CALL:

SERVICE DEPT  
503.9783343

#### CUSTOMER SUPPORT

503.978.3344

#### FAX:

503.978.3302

#### EMAIL:

support@carverpro.com

www.carverpro.com

**CARVER**  
PROFESSIONAL  
