



# Epson Stylus® Pro 4900

# Epson Stylus® Pro 4910

## User's Guide

---

---

## Copyrights and Trademarks

---

### **Copyrights and Trademarks**

No part of this publication may be reproduced, stored in a retrieval system, or transmitted in any form or by any means, electronic, mechanical, photocopying, recording, or otherwise, without the prior written permission of Seiko Epson Corporation. The information contained herein is designed only for use with this Epson printer. Epson is not responsible for any use of this information as applied to other printers.

Neither Seiko Epson Corporation nor its affiliates shall be liable to the purchaser of this product or third parties for damages, losses, costs, or expenses incurred by the purchaser or third parties as a result of accident, misuse, or abuse of this product or unauthorized modifications, repairs, or alterations to this product, or (excluding the U.S.) failure to strictly comply with Seiko Epson Corporation's operating and maintenance instructions.

Seiko Epson Corporation shall not be liable for any damages or problems arising from the use of any options or any consumable products other than those designated as Original Epson Products or Epson Approved Products by Seiko Epson Corporation.

Seiko Epson Corporation shall not be held liable for any damage resulting from electromagnetic interference that occurs from the use of any interface cables other than those designated as Epson Approved Products by Seiko Epson Corporation.

EPSON®, EPSON STYLUS®, Epson UltraChrome® and SpectroProofer® are registered trademarks, and EPSON EXCEED YOUR VISION or EXCEED YOUR VISION is a trademark of Seiko Epson Corporation.

Microsoft®, Windows®, and Windows Vista® are registered trademarks of Microsoft Corporation.

Apple®, Macintosh®, Mac OS, and OS X are registered trademarks of Apple Inc.

Intel® is a registered trademark of Intel Corporation.

PowerPC® is a registered trademark of International Business Machines Corporation.

Adobe®, Photoshop®, Elements®, Lightroom®, and Adobe® RGB are registered trademarks of Adobe Systems Incorporated.

*General Notice: Other product names used herein are for identification purposes only and may be trademarks of their respective owners. Epson disclaims any and all rights in those marks.*

© 2010 Seiko Epson Corporation. All rights reserved.

## Contents

### Copyrights and Trademarks

### Introduction

Important Safety Instructions. . . . .	6
When choosing a place for this product. . . . .	6
When setting up this product. . . . .	6
When using this product. . . . .	6
When handling the ink cartridges. . . . .	7
Warnings, Cautions, Notes and Tips. . . . .	7
Printer Parts. . . . .	8
Front section. . . . .	8
Rear/Spindle. . . . .	11
Control panel. . . . .	13
Screen View. . . . .	14
Printer Features. . . . .	17
Realizing High Resolution. . . . .	17
Realizing High Productivity. . . . .	18
Superior Ease of Use. . . . .	18
Notes on Usage and Storage. . . . .	19
Installation space. . . . .	19
Notes when using the printer. . . . .	19
Notes when not using the printer. . . . .	20
Notes on handling ink cartridges. . . . .	20
Notes on handling paper. . . . .	21
Introducing the Supplied Software. . . . .	23
Contents of the Software Disc. . . . .	23
Summary of the Printer Driver. . . . .	25

### Basic Operations

Loading and Removing the Roll Paper. . . . .	26
Printing and Reading Roll Paper Information . . . . .	26
Setting Auto Roll Paper Feeding. . . . .	27
Loading Roll Paper. . . . .	27
Cutting the roll paper. . . . .	31
Removing the roll paper. . . . .	32
Loading Cut Sheets. . . . .	34
Loading the Paper Cassette. . . . .	35
Loading Manually from the Rear. . . . .	39
Loading and Ejecting Thick Paper. . . . .	40
Basic Printing Methods(Windows). . . . .	43
Basic Printing Methods(Mac OS X). . . . .	44
Printable area. . . . .	46
Roll Paper Printable Area. . . . .	46
Cut Sheets Printable Area. . . . .	46

Changing the Type of Black Ink. . . . .	47
Turning Off the Power Using Power Management. . . . .	49
Canceling Printing. . . . .	50

### Using the Printer Driver(Windows)

Displaying the Settings Screen. . . . .	51
From the Printer icon. . . . .	51
Displaying Help. . . . .	52
Click the Help Button to Display. . . . .	52
Right-click on the item you want to check and display. . . . .	52
Customizing the Printer Driver. . . . .	53
Saving various settings as your Select Settings . . . . .	53
Saving media settings. . . . .	53
Rearranging display items. . . . .	54
Summary of the Utility Tab. . . . .	55
Uninstalling the printer driver. . . . .	56

### Using the Printer Driver(Mac OS X)

Displaying the Settings Screen. . . . .	58
Displaying Help. . . . .	58
Using Epson Printer Utility 4. . . . .	58
Starting Epson Printer Utility 4. . . . .	58
Epson Printer Utility 4 Functions. . . . .	58
Uninstalling the printer driver. . . . .	59
Removing EPSON LFP Remote Panel 2. . . . .	60

### Printing Varieties

Auto Correct Color and Print Photos (PhotoEnhance). . . . .	61
Correct color and print. . . . .	62
Printing Black and White Photos. . . . .	65
Borderless printing. . . . .	68
Types of Borderless Printing Methods. . . . .	68
Supported Media Sizes for Borderless Printing . . . . .	69
About Roll Paper Cutting. . . . .	70
Setting Procedures for Printing. . . . .	71
Enlarged/Reduced Printing. . . . .	73
Fit to Page/Scale to fit paper size. . . . .	73
Fit to Roll Paper Width(Windows only). . . . .	74
Custom Scale Setting. . . . .	75

## Contents

Multi-Page Printing. . . . .	76
Manual Double-Sided Printing(Windows only) . . . . .	78
Cautions when Performing Double-Sided Printing. . . . .	78
Setting Procedures for Printing. . . . .	78
Poster Printing (Enlarge to cover several sheets and print - Windows only). . . . .	79
Setting Procedures for Printing. . . . .	80
Joining the output paper together. . . . .	81
Printing on custom paper. . . . .	83
Banner printing (on roll paper). . . . .	86
Layout Manager(Windows only). . . . .	89
Setting Procedures for Printing. . . . .	90
Saving and Calling Layout Manager Settings. . . . .	91

### Color Management Printing

About Color Management. . . . .	92
Color Management Print Settings. . . . .	92
Setting profiles. . . . .	93
Setting color management with the application. . . . .	93
Setting color management with the printer driver . . . . .	94
Color management printing by Host ICM (Windows). . . . .	94
Color management printing by ColorSync (Mac OS X). . . . .	95
Color management printing by Driver ICM(Windows only). . . . .	96

### Using the Control Panel Menu

Menu Operations. . . . .	99
Menu List. . . . .	101
Details of the Menu. . . . .	103
Printer Setup menu. . . . .	103
Test Print menu. . . . .	105
Maintenance menu. . . . .	105
Printer Status menu. . . . .	106
Paper Setup menu. . . . .	106
Head Alignment menu. . . . .	110
Network Setup menu. . . . .	111
SpectroProofer menu. . . . .	111
Ink Menu Table. . . . .	112

### Maintenance

Adjusting the Print Head. . . . .	113
Checking for clogged nozzles. . . . .	113

Cleaning the print head. . . . .	115
Correcting Print Misalignment (Print Head Alignment). . . . .	117
Replacing Consumables. . . . .	120
Replacing Ink Cartridges. . . . .	120
Replacing Maintenance Box 1 and 2. . . . .	121
Replacing the Cutter. . . . .	124
Cleaning the Printer. . . . .	127
Cleaning the outside. . . . .	127
Cleaning the inside. . . . .	127

### Problem Solver

When an Error Message is Displayed. . . . .	129
When a Maintenance Call/Service Call Occurs . . . . .	137
Troubleshooting. . . . .	138
You cannot print (because the printer does not work). . . . .	138
The printer sounds like it is printing, but nothing prints. . . . .	141
The prints are not what you expected. . . . .	142
Feeding or ejecting problems. . . . .	146
Others. . . . .	149

### Appendix

Options and Consumable Products. . . . .	151
Supported Media. . . . .	153
Epson Special Media Table. . . . .	153
Usable Commercially Available Paper Size. . . . .	158
Before printing on non-Epson media. . . . .	158
Maintenance Mode. . . . .	159
Starting and Ending Maintenance Mode. . . . .	159
Maintenance Mode List. . . . .	160
Notes When Moving or Transporting the Printer . . . . .	162
Before Moving or Transporting. . . . .	162
Notes on Transporting. . . . .	162
After Moving or Transporting. . . . .	162
System Requirements. . . . .	163
Specifications Table. . . . .	163
Standards and Approvals. . . . .	164

### Where To Get Help

Technical Support Web Site. . . . .	165
Contacting Epson Support. . . . .	165
Before Contacting Epson. . . . .	165
Help for Users in North America. . . . .	166

## Contents

Help for Users in Europe. . . . .	166
Help for Users in Taiwan. . . . .	166
Help for Users in Australia. . . . .	167
Help for Users in Singapore. . . . .	167
Help for Users in Thailand. . . . .	168
Help for Users in Vietnam. . . . .	168
Help for Users in Indonesia. . . . .	168
Help for Users in Hong Kong. . . . .	169
Help for Users in Malaysia. . . . .	169
Help for Users in India. . . . .	169
Help for Users in the Philippines. . . . .	170

### **Software License Terms**

Open Source Software Licenses. . . . .	171
Bonjour. . . . .	171
Other Software Licenses. . . . .	176
Info-ZIP copyright and license. . . . .	176

## Introduction

---

# Introduction

---

## Important Safety Instructions

Read all of these instructions before using the printer. Also be sure to follow all warnings and instructions marked on the printer.

---

### When choosing a place for this product

- ❑ Place this product on a flat, stable surface that is larger than this product. This product will not operate properly if it is tilted or at an angle.
- ❑ Avoid places subject to rapid changes in temperature and humidity. Also keep it away from direct sunlight, strong light, or heat sources.
- ❑ Avoid places subject to shocks and vibrations.
- ❑ Keep this product away from dusty areas.
- ❑ Place this product near a wall outlet where the plug can be easily unplugged.

---

### When setting up this product

- ❑ Do not block or cover the openings in this product's cabinet.
- ❑ Do not insert objects through the slots. Take care not to spill liquid on this product.
- ❑ This product's power cord is for use with this product only. Use with other equipment may result in fire or electric shock.
- ❑ Connect all equipment to properly grounded power outlets. Avoid using outlets on the same circuit as copiers or air control systems that regularly switch on and off.
- ❑ Avoid electrical outlets controlled by wall switches or automatic timers.

- ❑ Keep the entire computer system away from potential sources of electromagnetic interference, such as loudspeakers or the base units of cordless telephones.
- ❑ Use only the type of power source indicated on the product's label.
- ❑ Use only the power cord that comes with this product. Use of another cord may result in fire or electric shock.
- ❑ Do not use a damaged or frayed power cord.
- ❑ If you use an extension cord with this product, make sure the total ampere rating of the devices plugged into the extension cord does not exceed the cord's ampere rating. Also, make sure the total ampere rating of all devices plugged into the wall outlet does not exceed the wall outlet's ampere rating.
- ❑ Do not attempt to service this product yourself.
- ❑ Unplug this product and refer servicing to qualified service personnel under the following conditions:

The power cord or plug is damaged; liquid has entered the product; the product has been dropped or the cabinet damaged; the product does not operate normally or exhibits a distinct change in performance.

- ❑ If you plan to use the printer in Germany, observe the following:

To provide adequate short-circuit protection and over-current protection for this printer, the building installation must be protected by a 10 or 16 amp circuit breaker.

- ❑ If damage occurs to the plug, replace the cord set or consult a qualified electrician. If there are fuses in the plug, make sure you replace them with fuses of the correct size and rating.

---

### When using this product

- ❑ Do not put your hand inside this product or touch the ink cartridges while printing.
- ❑ Do not move the print head by hand; otherwise you may damage this product.

## Introduction

- ❑ Always turn the product off using the Power button on the control panel. When this button is pressed, the Power light flashes briefly then goes off. Do not unplug the power cord or turn off the product until the Power light stops flashing.



---

## When handling the ink cartridges

- ❑ Keep ink cartridges out of the reach of children and do not drink.
- ❑ If ink gets on your skin, wash it off with soap and water. If it gets in your eyes, flush them immediately with water.
- ❑ Before installing the new ink cartridge in the printer, shake it back and forth horizontally in five centimeter movements about 15 times within five seconds.
- ❑ Use the ink cartridge before the date printed on its package.
- ❑ Use up the ink cartridge within six months of installation for best results.
- ❑ Do not dismantle the ink cartridges or try to refill them. This could damage the print head.
- ❑ Do not touch the green IC chip on the side of the cartridge. This may affect normal operation and printing.
- ❑ The IC chip on this ink cartridge retains a variety of cartridge-related information, such as the ink cartridge status, so that the cartridge may be removed and reinserted freely.
- ❑ If you remove an ink cartridge for later use, protect the ink supply area from dirt and dust, and store it in the same environment as this product. Note that there is a valve in the ink supply port, making covers or plugs unnecessary, but care is needed to prevent the ink from staining items that the cartridge touches. Do not touch the ink supply port or surrounding area.

---

## Warnings, Cautions, Notes and Tips

 <b>Warning:</b>	Warnings must be followed to avoid serious bodily injury.
 <b>Caution:</b>	Cautions must be followed to avoid damage to this product or bodily injury.
<b>Note:</b>	Notes contain important information on the operation of this product.
<b>Tip:</b>	Tips contain useful or additional information on the operation of this product.

## Introduction

## Printer Parts

## Front section

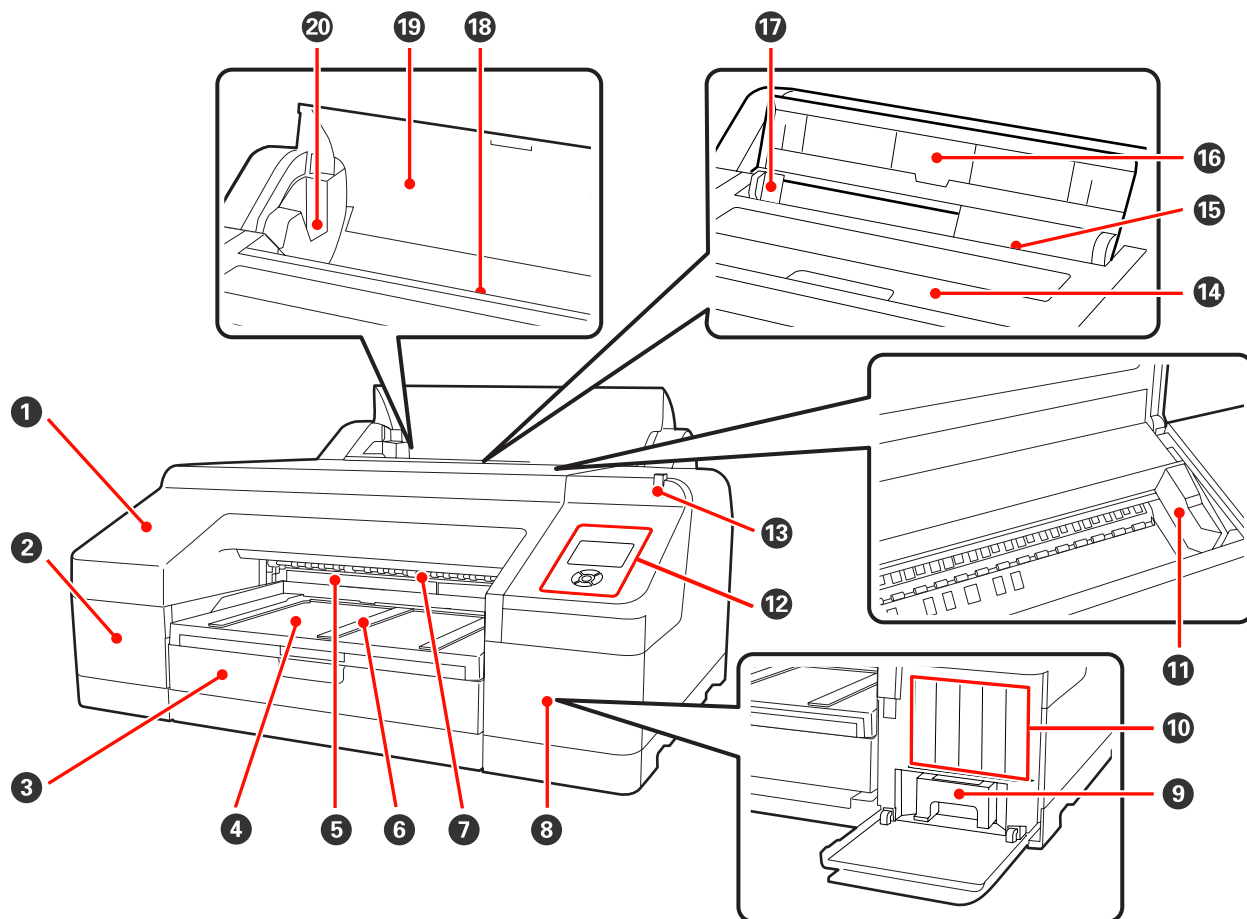
**1 Front cover**

Remove when replacing the built-in cutter or installing the optional SpectroProofer. Normally installed when using the printer.

**2 Cartridge cover (left)**

Open when replacing ink cartridges. [☞ “Replacing Ink Cartridges” on page 120](#)

**3 Paper cassette**

Load cut sheets from 8 to 17 inches wide. [☞ “Loading the Paper Cassette” on page 35](#)

**4 Output tray**

Ejected paper is collected here. Extend according to the size of the paper being ejected.

**5 Maintenance Box 2**

This box collects waste ink when printing beyond the edges of the paper for borderless printing.



## Introduction

### 6 Paper eject support

Support smooth ejection of the printed paper by raising the supports when printing on plain roll paper and when the optional SpectroProofer is installed.  [“Loading roll paper” on page 29](#)

### 7 Front manual feeder

Feed paper into this slot when printing on cut sheets that are 0.8 mm thick or thicker.  [“Loading and Ejecting Thick Paper” on page 40](#)

### 8 Cartridge cover (right)

Open when replacing ink cartridges or Maintenance Box 1.

 [“Replacing Ink Cartridges” on page 120](#)

 [“Replacing Maintenance Box 1” on page 121](#)

### 9 Maintenance Box 1

Container for collecting waste ink.

### 10 Ink cartridges

Install ink cartridges on the left and right for a total of 11 colors. Ink cartridge order  [“Screen View” on page 14](#)

### 11 Print head

Fires ink via high density nozzles while moving left and right to print.

Do not move the print head by hand.

### 12 Control panel

 [“Control panel” on page 13](#)

### 13 Alert lamp

Lit or flashing when an error or warning occurs in the printer.

On : An error occurred. Check the contents of the error on the control panel's screen.

Flashing : An ink or paper low warning occurred. You can specify for which consumable this warning should occur. The factory setting is Off (no warning).  [“Maintenance Mode List” on page 160](#)

Off : No error.

### 14 Printer cover

Open when loading thick paper, cleaning the inside of the printer, or removing jammed paper. Normally closed when using the printer.

### 15 Rear manual feeder

## Introduction

Manually feed paper into this slot when printing cut sheets one at a time.  [“Loading Manually from the Rear” on page 39](#)

### 16 Paper support

Raise this support when manually feeding paper to load the paper properly. Supports paper to prevent it from falling forward or backward.

### 17 Edge guide

Move left and right depending on the size of the paper that you want to load. This prevents paper being fed at a slant.

### 18 Roll paper feeder

Paper feed slot for roll paper printing.  [“Loading Roll Paper” on page 27](#)

### 19 Roll paper cover

Cover to protect the roll paper. Except when loading or removing roll paper, it should be closed when using the printer.

### 20 Spindle holders

Hold the spindle loaded with roll paper on the left and the right.

 [“Loading roll paper” on page 29](#)

## Introduction

## Rear/Spindle

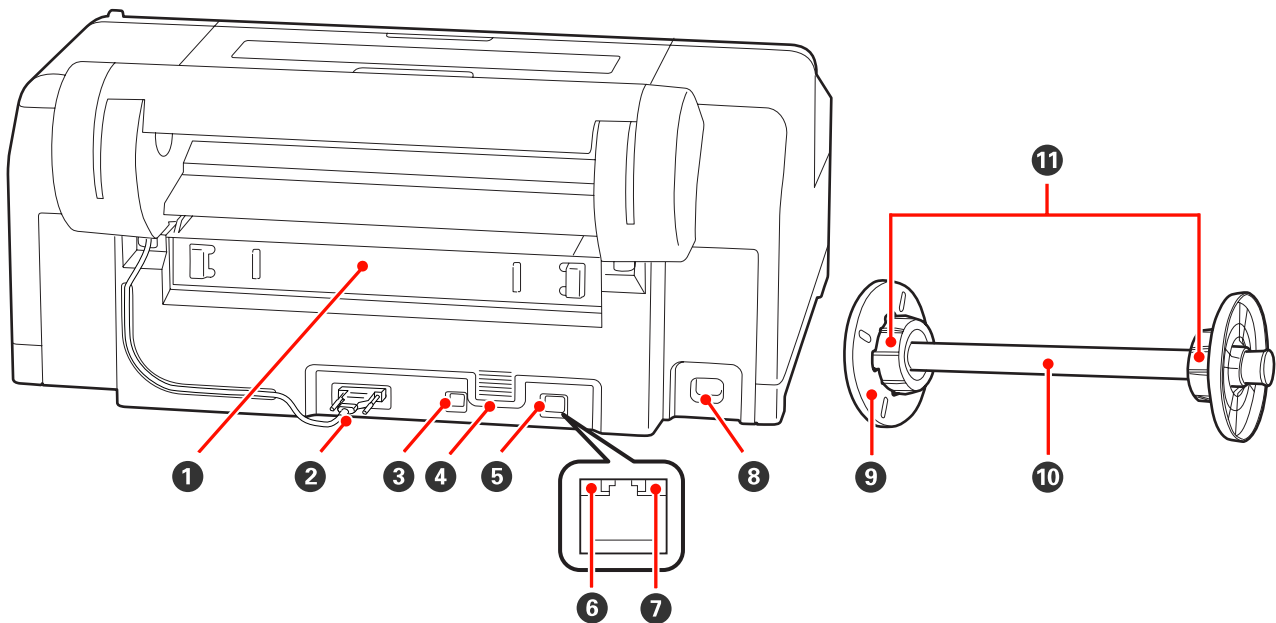

- 1 Rear unit**  
Remove if the paper jams, and then clear the jammed paper. Normally installed when using the printer.
- 2 Roll paper holder unit connector**  
Always use with the cable connected.
- 3 USB interface connector**  
Connects the USB cable.
- 4 Airflow vents**  
Vents the air used to cool the inside of the printer.
- 5 LAN connector**  
Connects the LAN cable.
- 6 Status light (green and red)**  
The color indicates the network transmission speed.
- |       |   |            |
|-------|---|------------|
| Green | : | 10Base-T   |
| Red   | : | 100Base-TX |
- 7 Data light (orange)**  
The network connection status and data reception are indicated by a lit or flashing light.

## Introduction

On : Connected.

Flashing : Receiving data.

### 8 AC inlet

Connects the power cable.

### 9 Movable flange (black)

Fixes the roll paper placed on the spindle. Remove and install when loading or removing roll paper on the spindle.

### 10 Spindle

When you want to load roll paper into the printer, place the roll paper on the spindle.

### 11 Attachment

Install when placing roll paper with a three inch paper core on the spindle.

Introduction

Control panel

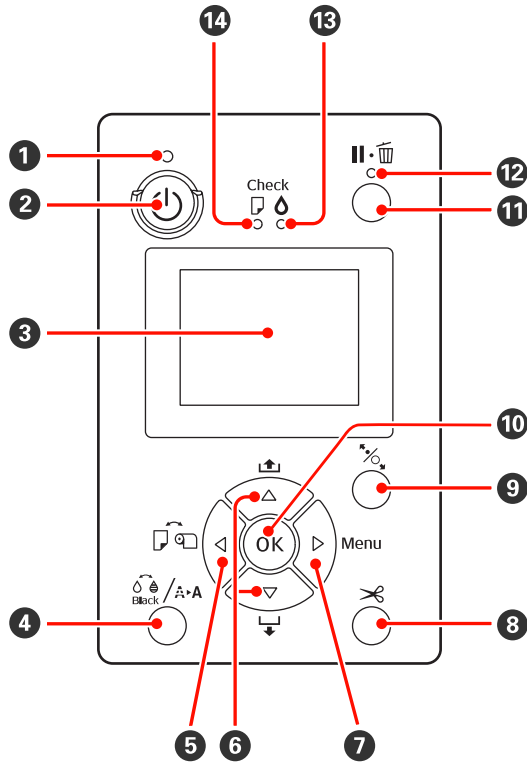

1 **light (Power light)**

The printer's operational status is indicated by a lit or flashing light.

On : The power is on.

Flashing : Receiving data or performing processes such as turning off the power, head cleaning, auto nozzle check, or changing the type of black ink.

Off : The power is off.

2 **button (Power button)**

Turns the power on and off.

3 **Screen**

Displays the printer's status, menus, error messages, and so on. ["Screen View" on page 14](#)

4 **button (Ink menu button)**

If pressed in the ready status, the Ink Menu is displayed on the screen, and you can clean the print head, perform a nozzle check, or switch the type of black ink. If pressed while printing is paused, you cannot switch the type of black ink. ["Ink Menu Table" on page 112](#)

5 **button (Paper Source button)**

If pressed in the ready status, or when no paper is loaded, the Paper Type menu is displayed, and you can switch between roll paper and cut sheets, and check the paper loading method. When settings are changed, the screen icons change as shown below. You can also make the same settings from the printer driver. When printing from the printer driver, the printer driver settings are given priority regardless of the settings on the control panel.



: Prints on roll paper and cuts automatically after printing each page.



: Prints on roll paper but does not cut after printing.



: Prints on cut sheets.

Returns to the previous screen (Parameter > Item > Menu > Ready) if pressed while the Menu is displayed.

6 **▲/▼ buttons (Paper Feed buttons)**

When roll paper is loaded, you can feed (▼ button) or rewind (▲ button) the roll paper. You can feed up to 3 m of paper by holding down the ▼ button. You can speed up the paper feed rate by holding down the button for at least two seconds.

You can rewind up to 20 cm of paper by holding down the ▲ button.

If you press the ▼ button when no roll paper is loaded and **Cut Sheet** is selected from the Paper Type menu, paper is fed from the paper cassette and ejected. ["Cleaning the paper cassette printing path" on page 127](#)

When feeding cut sheets from the rear manual feeder, press the ▼ button to feed the paper and enter ready status. ["Loading Manually from the Rear" on page 39](#)

If pressed while the Menu is displayed, you can select items and parameters. ["Menu Operations" on page 99](#)

## Introduction

### 7 ▶ button (Menu button)

- ❑ If pressed in the ready status or when no paper is loaded, the Menu is displayed. [☞ "Menu Operations" on page 99](#)
- ❑ If pressed while printing, the **Printer Status** menu from the Menu is displayed directly. [☞ "Printer Status menu" on page 106](#)
- ❑ Goes to the next screen (Menu > Item > Parameter) if pressed while the Menu is displayed.

### 8 ✂ button (Paper Cut button)

Press to cut roll paper with the built-in cutter. [☞ "Manual cut method" on page 32](#)

### 9 % button (Paper Set button)

- ❑ This button locks or unlocks the paper presser.
  - [☞ "Loading and Ejecting Thick Paper" on page 40](#)
  - [☞ "Loading roll paper" on page 29](#)
- ❑ When pressed after roll paper printing is complete, the paper presser is unlocked, roll paper is automatically wound up and can be removed. When **Remaining Paper Setup** is set to **On** from the Menu, the roll paper is wound up after printing a barcode on the edge of the paper indicating paper information such as the amount of remaining roll paper. [☞ "Printing and Reading Roll Paper Information" on page 26](#)

### 10 OK button

- ❑ If pressed while a parameter is selected from the Menu, the parameter is set or executed.
- ❑ If pressed while the ink is drying, the drying process is canceled.

### 11 ⏸ button (Pause/Cancel button)

- ❑ The printer enters pause status if this is pressed while printing. To release the pause status, press the ⏸ button again, or select **Pause Cancel** on the screen and then press the OK button. To cancel print jobs being processed, select **Job Cancel** on the screen and then press the OK button. [☞ "Canceling Printing" on page 50](#)
- ❑ If pressed while the Menu is displayed, the Menu is closed and it returns to ready status.

### 12 ⏸ light (Pause light)

Indicates whether or not the printer is ready to print.

- On : Not ready to print. Pausing or canceling job.

- Off : Ready to print.

### 13 🔆 light (Ink Check light)

The ink status is indicated by a lit or flashing light.

- On : Indicates errors such as an installed ink cartridge is expended, an ink cartridge is not installed, or a wrong ink cartridge is installed. Check the contents of the error on the control panel's screen.

- Flashing : The ink is low. We recommend replacing the ink cartridge as soon as possible because the ink may be expended while printing.

- Off : No error.

### 14 📄 light (Paper Check light)

The paper status is indicated by a lit or flashing light.

- On : No paper loaded or the paper setting is not correct. Check the contents of the error on the control panel's screen.

- Flashing : Indicates errors such as paper jam, or paper skew. Check the contents of the error on the control panel's screen.

- Off : No error.

## Screen View

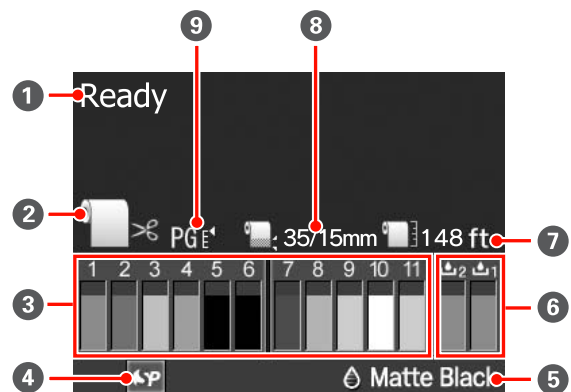

### 1 Message

## Introduction

Displays the printer's status, operation, and error messages.

[☞ “When an Error Message is Displayed” on page 129](#)

### 2 Paper Source Settings

The following icons indicate the paper source status set by the ◀ button.

You can also make the same settings from the printer driver. When printing from the printer driver, the printer driver settings are given priority regardless of the settings on the control panel.



: Prints on roll paper and cuts automatically after printing each page.



: Prints on roll paper but does not cut after printing.



: Prints on cut sheets.

### 3 Ink Cartridge Status

Displays the approximate level of remaining ink and the current status. The ink cartridge icons change as follows when the ink is low or an error occurs.

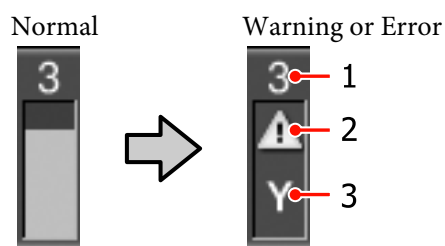

#### 1 Ink Slot Number

When facing the printer, the slots are numbered from left to right in ascending order from 1. The following shows the colors that correspond to the ink slot numbers.

- 1 GR (Green)
- 2 LLK (Light Light Black)
- 3 Y (Yellow)
- 4 LC (Light Cyan)
- 5 VLM (Vivid Light Magenta)
- 6 OR (Orange)
- 7 MK (Matte Black)
- 8 VM (Vivid Magenta)
- 9 LK (Light Black)
- 10 C (Cyan)
- 11 PK (Photo Black)

#### 2 Status indicators

The ink cartridge status is indicated as follows.

No alarm : There is sufficient ink and printing is possible.



: Ink is low. You need to prepare a new ink cartridge.



: An error occurred. Check the message on the screen, and clear the error.

#### 3 Ink color codes

See the list in 1 (above) for the colors that correspond to the codes.

#### Tip:

You can check the remaining ink level more reliably in *Printer Status from the Menu*, or from *EPSON Status Monitor in the printer driver*. We recommended checking the remaining ink level before printing a large job, and preparing a new cartridge for any ink cartridges that are running low.

[☞ “Printer Status menu” on page 106](#)

Windows [☞ “Summary of the Utility Tab” on page 55](#)

Mac OS X [☞ “Using Epson Printer Utility 4” on page 58](#)

## Introduction

**4 SpectroProofer Usage Status**

The following icons indicate the installation status of the optional SpectroProofer.



: Installed.

No icon : Not installed, or it is not installed correctly.

**5 Type of black ink**

Displays the selected type of black ink.

**6 Maintenance Box Status**

The status of Maintenance Box 1 and 2 is indicated as follows.



: There is enough space in the maintenance box.



: The Maintenance Box is nearing the end of its service life. You need to prepare a new Maintenance Box. (flashing)



: Maintenance Box is at the end of its service life. Replace the Maintenance Box with a new one. (flashing)

**Tip:**

You can check the remaining space more reliably in Printer Status from the Menu, or from EPSON Status Monitor in the printer driver. We recommended checking the remaining space before power cleaning and so on, and preparing a new Maintenance Box if it is nearing the end of its service life.

[“Printer Status menu” on page 106](#)

Windows [“Summary of the Utility Tab” on page 55](#)

Mac OS X [“Using Epson Printer Utility 4” on page 58](#)

**7 Remaining Paper**

The following icons indicate the remaining amount of loaded paper.

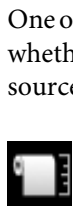

: The amount of remaining roll paper (length) is indicated after the icon. This is displayed only when **Remaining Paper Setup** is set to **On**.

[“Printing and Reading Roll Paper Information” on page 26](#)



: The amount of remaining paper (number of sheets) in the paper cassette is indicated after the icon. This is displayed only when **Cut Sheet Remaining** is set to **On** in the Maintenance Mode menu and **Cut Sheet Remaining** is set from the Menu.

[“Maintenance Mode” on page 159](#)

[“Paper Setup menu” on page 106](#)

**8 Roll Paper Margin Parameter**

The following **Roll Paper Margin** settings from the Menu are displayed after the icon.

Auto : **Default**

15 mm : **Top/Bottom 15mm**

35/15 mm : **Top 35/Bottom 15mm**

3 mm : **3mm**

15 mm : **15mm**

[“Printer Setup menu” on page 103](#)

**9 Platen Gap Settings/Custom Paper Registered Number**

The following icons indicate the current **Platen Gap** settings.

[“Printer Setup menu” on page 103](#)

No icon : **Standard**



## Introduction

 : Narrow

 : Wide

 : Wider

 : Widest

- Indicates the selected number out of **Custom Paper** in the Menu.

 ["Paper Setup menu" on page 106](#)

## Printer Features

This printer is a wide-format ink jet color printer supporting 17 inch paper.

The main features of this printer are described below.

---

### Realizing High Resolution

By implementing Epson UltraChrome HDR Ink technology, we provide high-resolution printing to meet professional needs.

#### **Expansion of the color reproduction area providing a wider range of expression**

By using 10 color inks that include orange and green, color ranges from bright, vibrant green to yellow as well as yellow to red have been expanded even further.

#### **Realizing an even gray balance without color casting**

Fine black & white gradation has been achieved by using three density types for black ink.

#### **Providing two types of black ink to match the paper type**

You can choose from photo black ink or matte black ink depending on the paper type. Photo black ink provides a smooth finish to glossy photo papers. Matte black ink increases black optical density for matte type papers.

This printer allows you to set both photo black ink and matte black ink and switch between them depending on the paper type.

 ["Changing the Type of Black Ink" on page 47](#)

#### **Decreasing light dependency maintains an even color under different environments\***

By using 10 color inks, we have reduced "light dependency (color inconsistency)" in which the color balance shifts due to differences in environmental light.

\* These are measured results using A/F11 light sources against a D50 light source.

#### **Long life prints**

Pigment inks maintain more beautiful and more vibrant prints over a long period of time since their high water and ozone resistance and high light fastness prevent the inks from being broken down by light and ozone in the air.

## Introduction

---

### Realizing High Productivity

#### Excellent color stability leads to efficient printing

The color stabilizes in a short time so it can safely be used for pre-press workflow and color editing, increasing work efficiency.

#### Automatically switch roll paper and cut sheets for printing

You can load roll paper in the printer and load cut sheets in the paper cassette at the same time. The required paper is automatically fed if you specify the paper source when printing.

[“Loading roll paper” on page 29](#)

#### Auto nozzle check prevents printing mistakes

Missing dots are detected on all nozzles extremely quickly and head cleaning is performed automatically if any missing dots are detected. This prevents printing mistakes, and reduces unnecessary costs and wasted time.

[“Adjusting the Print Head” on page 113](#)

#### Improved operability with an easy to see and use color screen

The large and bright color screen displays the printer status such as the remaining ink level.

[“Screen View” on page 14](#)

With a larger display area, error messages and other information can be presented clearly and in an easy to read format. You can also check how to load the paper.

#### Checking current operating status even from afar thanks to an alert lamp

When an error occurs, or when ink or paper is running low, you can easily check the status of the printer even from afar thanks to a highly visible, alert lamp. [“Maintenance Mode List” on page 160](#)

This helps prevent any wasted time when printing has stopped due to running out of ink or paper.

#### Realizing high productivity through continuous printing

Our paper cassettes, which can be used even for glossy paper, can hold up to 250 sheets of plain paper (for paper 0.1 mm thick) or up to 100 sheets of Epson proofing paper.

Also, up to 50 sheets of printed paper can be held in the output tray. When the number of sheets that can be loaded in the paper cassette is less than 50, the maximum number of sheets that can be held in the output tray is the same as the number of sheets in the paper cassette. This helps to reduce the burden of handling output paper or replenishing cut sheets. [“Loading the Paper Cassette” on page 35](#)

#### Automated post-process by using the SpectroProofer (optional)

You can automate the color management process by installing the optional SpectroProofer. You can achieve highly reliable color management by using features such as automated color calibration, print authentication, and profile creation.

#### Simplified setting operations when changing roll paper

When changing between many different types of roll paper for your printing, you can automatically make settings by using the barcode printing function, as the printer reads the recorded information such as the paper type, the amount of remaining roll paper, and low paper warning values.

[“Printing and Reading Roll Paper Information” on page 26](#)

#### Improved paper cutting speed

With the addition of a high speed rotary cutter you can cut paper faster than ever.

[“Cutting the roll paper” on page 31](#)

---

### Superior Ease of Use

#### Supporting network as standard

A network interface with support for 100BASE-TX and 10BASE-T is installed as standard, allowing the printer to communicate by Ethernet.

#### Borderless printing function

You can print with no margins for all directions with both auto expand or retain size print settings. [“Borderless printing” on page 68](#)

Also included is a poster printing function that allows you to join the output paper together when performing borderless printing in order to create large posters and calendars. [“Poster Printing \(Enlarge to cover several sheets and print - Windows only\)” on page 79](#)

## Introduction

### Freely placing print data made by various applications using Layout Manager

This function allows you to place multiple print data made by different applications freely on one sheet to create posters and display articles.

 [“Layout Manager\(Windows only\)” on page 89](#)

### Improved energy efficiency with sleep mode and Power Management

When no print jobs are being handled, or when no operation has been performed for some time, the printer enters sleep mode to reduce power consumption.

Furthermore, if the Power Management function is enabled, the printer can automatically switch off to avoid wasting electricity. This function works if no print jobs are received and no operations are carried out on the control panel while the printer is not in an error status for a specified duration of time.

 [“Maintenance Mode” on page 159](#)

## Notes on Usage and Storage

### Installation space

Make sure that you secure the following space, clear of any other objects, so that paper ejection and consumable replacement are not obstructed.

See the "Specifications Table" for the external dimensions of the printer.

 [“Specifications Table” on page 163](#)

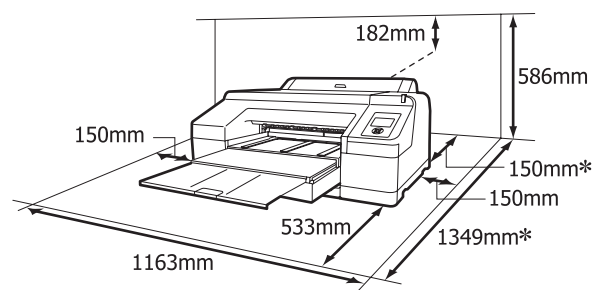

\* The following space is necessary at the rear of the printer when printing on thick paper and when printing from a paper cassette with the optional SpectroProofer installed.

Paper Size	Rear Space
A2	Approx. 370 mm
Super A3	Approx. 260 mm
A3	Approx. 200 mm
A4	Approx. 70 mm

### Notes when using the printer

Note the following points when using this printer to avoid breakdowns, malfunctions, and print quality decline.

## Introduction

- ❑ When using the printer, observe the operating temperature and humidity range described in the "Specifications Table".  ["Specifications Table" on page 163](#)

Even when the conditions above are met, you may not be able to print properly if the environmental conditions are not suitable for the paper. Be sure to use the printer in an environment where the paper's requirements are met. For more details, see the manual supplied with the paper.

Also, when operating in dry areas, air conditioned environment, or under direct sunlight, maintain the appropriate humidity.

- ❑ Capping may not occur (the print head is not positioned on the right-hand side) if the printer is turned off during a paper jam or when an error occurs. Capping is a function for automatically covering the print head with a cap (lid) to prevent the print head from drying out. In this case, turn on the power and wait a while until capping is performed automatically.
- ❑ When the power is on, do not remove the power plug or cut the power at the breaker. The print head may not be capped properly. In this case, turn on the power and wait a while until capping is performed automatically.
- ❑ Do not move the print head by hand.

---

### Notes when not using the printer

If you are not using it, note the following points when storing the printer. If it is not stored correctly, you may not be able to print properly the next time it is used.

- ❑ If you do not print for a long time, the print head nozzles may become clogged. We recommend that you print once a week to prevent the print head from clogging.
- ❑ If the paper is left in the printer, the roller of the paper presser may leave a mark on the surface of the paper. This can also cause wavy or curled paper resulting in paper feeding problems or the print head could be scratched. Remove any paper when storing.

- ❑ Store the printer after confirming that the print head has been capped (the print head is positioned at the far right). If the print head is left uncapped for a long time, the print quality may decline.

**Tip:**

*If the print head is not capped, turn the printer on, and then turn it off.*

- ❑ Close the roll paper cover and printer cover before storing. If you are not using the printer for a long time, put an anti-static cloth or cover on the printer to prevent dust. The print head nozzles are very small, and they can become clogged easily if fine dust gets on the print head, and you may not be able to print properly.
- ❑ If you have not used the printer for a long time, check the print head for clogging before you start printing. Perform head cleaning if the print head is clogged.

 ["Checking for clogged nozzles" on page 113](#)

---

### Notes on handling ink cartridges

Note the following points when handling ink cartridges to maintain good print quality.

- ❑ The included ink cartridges and installed Maintenance Box 1 are just for initial ink charging. You may need to replace the ink cartridge or Maintenance Box 1 soon.
- ❑ We recommend storing ink cartridges at normal room temperature, and to use them by the expiry date printed on the cartridge packaging.
- ❑ For the best printing results, use up the ink cartridge within six months of installation.
- ❑ If you move ink cartridges from a cold place to a warm place, leave it at room temperature for more than four hours before using the ink cartridge.
- ❑ Do not touch the green IC chip on the ink cartridges. You may not be able to print properly.
- ❑ Install ink cartridges into all slots. You cannot print if any slot is empty.

## Introduction

- ❑ Do not leave the printer without ink cartridges installed. If the print head (nozzles) dries, you may not be able to print. Leave ink cartridges in all slots even while you do not use the printer.
- ❑ Because the green IC chip contains the cartridge's own information such as the remaining ink level, you can still reinstall and use the ink cartridge after removing it from the printer.
- ❑ To avoid getting dirt on the ink supply port, store the removed ink cartridge properly. The ink supply port has a valve in it so it does not need to be capped.
- ❑ Removed ink cartridges may have ink around the ink supply port, so be careful not to get any ink on the surrounding area.
- ❑ To maintain the quality of the print head, this printer stops printing before ink cartridges are completely expended.
- ❑ Although the ink cartridges may contain recycled materials, this does not effect printer function or performance.
- ❑ Do not dismantle or remodel ink cartridges. You may not be able to print properly.
- ❑ Do not drop or knock it against hard objects; otherwise, the ink may leak.

---

### Notes on handling paper

Note the following points when handling and storing the paper. If the paper is not in good condition, print quality may decline.

Check the manuals supplied with each paper.

### Notes on Handling

- ❑ Use Epson special media under normal room conditions (temperature: 15 to 25 °C; humidity: 40 to 60 %).
- ❑ Do not fold the paper or scratch the surface of the paper.
- ❑ Avoid touching the printable surface of the paper with your bare hands. Moisture and oils from your hands can affect print quality.
- ❑ Handle roll paper by holding the edges. We recommend wearing cotton gloves.
- ❑ Cut sheets may be wavy or slack if the temperature and humidity change. Be careful not to scratch or soil the paper, and flatten it before loading it in the printer.
- ❑ Do not wet the paper.
- ❑ Do not throw away the paper packaging as you can use it for storing the paper.
- ❑ Avoid locations that are subject to direct sunlight, excessive heat, or humidity.
- ❑ Keep cut sheets in their original package after opening, and keep them in a flat place.
- ❑ Remove roll paper that is not in use from the printer. Rewind it correctly and then store it in the original packaging that came with the roll paper. If you leave the roll paper in the printer for a long time, its quality may decline.

### Notes on handling printed paper

To maintain long lasting, high quality print results, note the following points.

- ❑ Do not rub or scratch the printed surface. If they are rubbed or scratched, the ink may peel off.
- ❑ Do not touch the printed surface; the ink may peel off.
- ❑ Make sure the print outs are completely dry before folding or stacking; otherwise, the color may change where they touch (leaves a mark). These marks will disappear if they are separated immediately and dried; however, they will remain if not separated.
- ❑ If you put the print outs in an album before they are completely dry, they may be blurred.
- ❑ Do not use a dryer to dry the print outs.
- ❑ Avoid direct sunlight.
- ❑ Prevent color distortion while displaying or storing the print outs by following the instructions in the paper's manual.

## Introduction

**Tip:**

*Typically, print outs and photos fade over time (color distortion) due to the effects of light and various constituents in the air. This also applies to Epson special media. However, with the correct storage method, the degree of color distortion can be minimized.*

- ❑ *See the manuals supplied with Epson special media for detailed information on handling the paper after printing.*
- ❑ *The colors of photos, posters, and other printed materials appear different under different lighting conditions (light sources<sup>\*</sup>). The colors of print outs from this printer may also appear different under different light sources.*

*\* Light sources include sunlight, fluorescent light, incandescent light, and other types.*

## Introduction



# Introducing the Supplied Software

## Contents of the Software Disc

To use this printer, install the printer driver from the supplied software disc. The printer driver is already installed if you ran Easy Install when setting up.

As well as the printer driver, you can find the following software on the Software Disc supplied. Select from the Software List and install any software that was not installed by Easy Install as necessary.

### For Windows

Software Name	Installed by Easy Install	Summary
Printer Driver	✓	
Epson Network Utility	✓	<p>When the printer is connected to a computer via a network, this plug-in program acquires the status of the printer such as the remaining ink level, error status, and so on. The acquired information is displayed on the printer driver's Main screen and the EPSON Status Monitor 3 screen.</p> <p> <a href="#">"Summary of the Utility Tab" on page 55</a></p> <p>Normally, this software is installed with the printer driver. However, if the printer driver is installed without using the installer of the <i>Software Disc</i>, such as using the plug-and-play function of the OS, Epson Network Utility is not installed. In such a case, install Epson Network Utility from the Software List.</p>
ICC Profile (Adobe)	-	Install this when you need an input profile when performing color management.
EPSON LFP Remote Panel 2	-	<p>With this software, you can update the printer's firmware and make custom paper settings from your computer.</p> <p> <a href="#">"Summary of the Utility Tab" on page 55</a></p>
Printer Linearization	-	<p>With this software, you can perform high-accuracy color calibration with the optional SpectroProofer, or standard color calibration using the printer's built-in sensor.</p> <p> <a href="#">"Summary of the Utility Tab" on page 55</a></p>
EpsonNet Config	-	With this software, you can configure various network settings for the printer from your computer. This is useful as it allows you to enter addresses and names using the keyboard.
EpsonNet Print	✓ (When LAN connection is selected)	With this software, you can perform direct TCP/IP printing when the computer and the printer are connected via a network. This software is automatically installed if LAN connection is specified in Easy Install; however, it is not installed if USB connection is specified.

### For Mac OS X

Software Name	Installed by Easy Install	Summary
Printer Driver	✓	

## Introduction

Software Name	Installed by Easy Install	Summary
ICC Profile (Adobe)	-	Install this when you need to enter a profile when performing color management.
EPSON LFP Remote Panel 2	-	With this software, you can update the printer's firmware and make custom paper settings from your computer.  <a href="#">"Using Epson Printer Utility 4" on page 58</a>
EpsonNet Config	-	With this software, you can configure various network settings for the printer from your computer. This is useful as it allows you to enter addresses and names using the keyboard.



## Introduction

### Summary of the Printer Driver

The main functions of the printer driver are described below.

- ❑ Converts print data received from applications into printable data and sends it to the printer.
- ❑ Allows the user to specify print settings such as the media type and paper size.

#### Windows

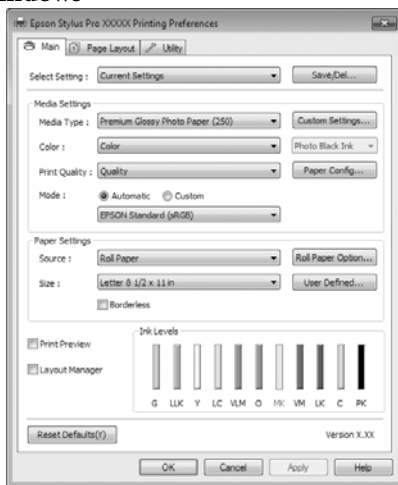

You can save these settings and easily import or export these saved settings.

[“Customizing the Printer Driver” on page 53](#)

#### Mac OS X

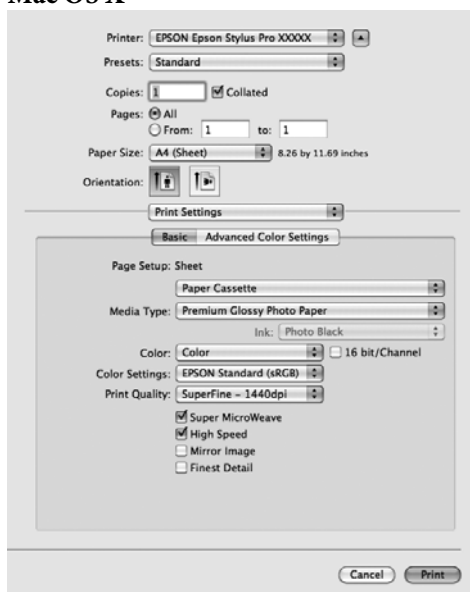

- ❑ Allows the user to execute printer maintenance functions to maintain print quality, and check the printer's status and so on.

#### Windows



You can easily import or export printer driver settings.

[“Summary of the Utility Tab” on page 55](#)

#### Mac OS X



## Basic Operations

### Loading and Removing the Roll Paper

We recommend setting **Remaining Paper Setup** before loading roll paper into the printer. See the following for more information on making settings.

Also, when loading the Epson special media UltraSmooth Fine Art Paper, you need turn the **Auto Roll Feeding** setting to **Off** in advance. To turn the setting to **Off**, see [“Setting Auto Roll Paper Feeding” on page 27](#)

### Printing and Reading Roll Paper Information

The printer can automatically print the following roll paper related settings in a barcode on the leading edge of the roll paper before the roll paper is removed.

- Roll Paper Remaining
- Roll Length Alert
- Paper Type

This is useful when multiple rolls are used because the barcode is read automatically and the paper settings are updated as roll paper is replaced.

To print roll paper information in a barcode and to read the printed information, set **Remaining Paper Setup** to **On** and configure the **Roll Paper Length** and the **Roll Length Alert** from the Menu.

The factory setting for **Remaining Paper Setup** is **Off**. You can change the setting using the following procedures.

**Note:**

- Press the **⏻** button when removing the roll paper. If you do not press the **⏻** button when removing the roll paper, the barcode is not printed and you cannot manage the roll paper information.
- If **Paper Size Check** is set to **Off** from the Menu, the amount of remaining paper may not be detected correctly. When **Remaining Paper Setup** is set to **On**, do not set **Paper Size Check** to **Off**. The factory setting for **Paper Size Check** is **On**.

[“Printer Setup menu” on page 103](#)

Buttons that are used in the following settings

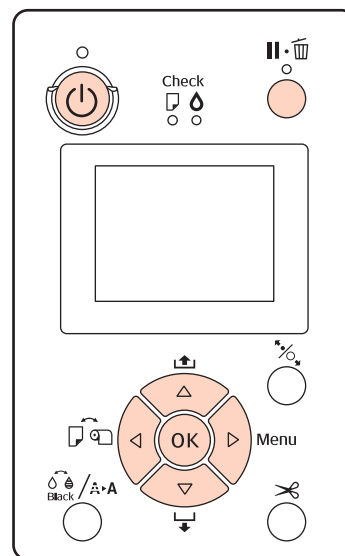

- 1 Turn on the printer by pressing the **⏻** button.
- 2 Check that paper is not loaded in the printer, and then press the **▶** button to display the Menu.
- 3 Press the **▼/▲** buttons to select **Paper Setup**, and then press the **▶** button.
- 4 Select **Roll Paper Remaining**, and then press the **▶** button.
- 5 Select **Remaining Paper Setup**, and then press the **▶** button.
- 6 Press the **▼/▲** buttons to select **On**, and then press the **OK** button.
- 7 Press the **◀** button to return to the previous screen.

## Basic Operations

- 8 Press the ▼/▲ buttons to select **Roll Paper Length**, and then press the ► button.
- 9 Press the ▼/▲ buttons to set the length of the roll paper, and then press the OK button.
- 10 Press the ◀ button to return to the previous screen.
- 11 Press the ▼/▲ buttons to select **Roll Length Alert**, and then press the ► button.
- 12 Press the ▼/▲ buttons to set when to display the running low warning (amount of remaining roll paper), and then press the OK button.
- 13 Press the ⏏ button to close the Menu.

### Setting Auto Roll Paper Feeding

The factory setting for **Auto Roll Feeding** is **On**.

When using the Epson special media UltraSmooth Fine Art Paper, set **Auto Roll Feeding** to **Off** from the Menu before loading it in the printer. If UltraSmooth Fine Art Paper is loaded while **Auto Roll Feeding** is set to **On**, the roller of the paper presser may leave a mark on the surface of the paper.

When using paper other than UltraSmooth Fine Art Paper, set it to **On**.

**Tip:**

The following differences in operation occur when turning this setting from **On** to **Off**.

- ❑ An error occurs if you try to switch to **Cut Sheet** in the Paper Type menu while roll paper is loaded. Remove the roll paper and then change to **Cut Sheet**.
- ❑ An error occurs if you try to print by specifying the paper cassette from the printer driver while roll paper is loaded. Remove the roll paper, change to **Cut Sheet** in the Paper Type menu, and then try again.

When using UltraSmooth Fine Art Paper, change the setting using the following procedure.

- 1 Make sure the printer is on.

- 2 Check that paper is not loaded in the printer, and then press the ► button to display the Menu.
- 3 Press the ▼/▲ buttons to select **Printer Setup**, and then press the ► button.
- 4 Select **Auto Roll Feeding**, and then press the ► button.
- 5 Press the ▼/▲ buttons to select **Off**, and then press the OK button.
- 6 Press the ⏏ button to close the Menu.

### Loading Roll Paper

#### Removing and installing the attachment

Load the roll paper into the printer after placing it on the spindle supplied with this printer.

Depending on the size of the paper core, follow the steps below to install or remove the attachment from the spindle.

- ❑ For two inch paper cores

The attachment is not necessary.

Because the attachment is installed on the spindle at the time of purchase, you need to remove it before use.

You may need the attachment for roll paper with a three inch paper core, make sure you keep it in a safe place after removing it.

- ❑ For three inch paper cores

The attachment is necessary.

## Basic Operations

### Removing the attachment (when using two inch paper cores)

- 1 Remove the black flange and the attachment from the spindle.

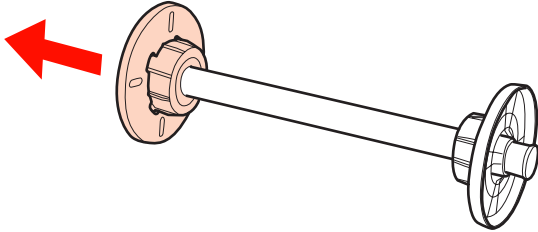

- 2 Remove the attachment from both flanges.

Press the hooks (two points) out to release the hooks, and then pull the attachment out of the flange.

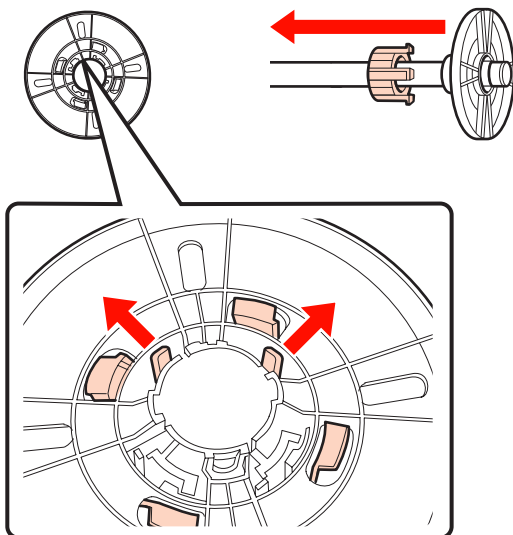

### Installing the attachment (when using three inch paper cores)

- 1 Remove the black flange from the spindle.

1

Remove the black flange from the spindle.

- 2 Install the attachment on both flanges.

2

Align the ▲ marks on the flange and attachment, and then push firmly until you hear the hooks click into place.

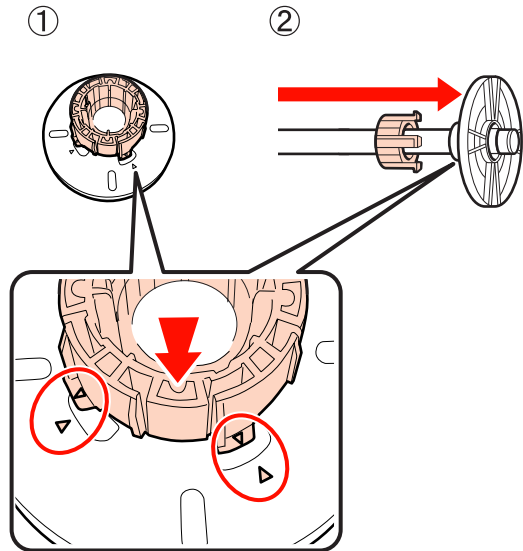

### Removing and installing the spacer

When you perform borderless printing on roll paper, you may need to install the spacer for borderless printing supplied with the printer, depending on the width of the roll paper.

However, you cannot install the spacer for roll paper with a three inch paper core, since it is already using the attachment. Paper widths that need the spacer installed for borderless printing [“Supported Media Sizes for Borderless Printing”](#) on page 69

#### Installing the spacer

- 1 Remove the black flange from the spindle.

1

When the attachment is installed in the spindle, remove both left and right attachments.

- 2 Install the spacer into the gray flange (fixed part).

2

Push the spacer until the holes in the spacer and the flange line up exactly.

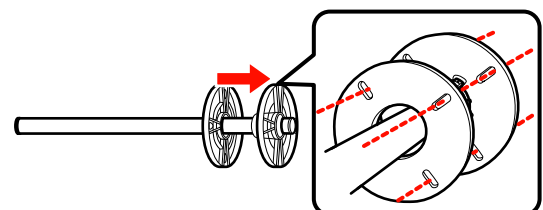

## Basic Operations

### Removing the spacer

- 1 Remove the black flange from the spindle.
- 2 Remove the spacer.
 

Hold the outer edge of the spacer and pull it straight off.

### Placing roll paper on the spindle

Follow the steps below to set roll paper on the spindle supplied with this printer.

- 1 Remove the black flange from the spindle.
- 2 Insert the spindle into the roll paper.
 

Place the roll paper on a flat surface where the end of the roll paper is hanging down towards you, and insert the spindle from the right.

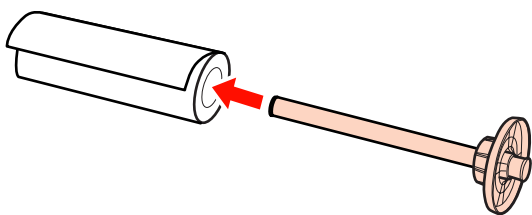

- 3 Install the black flange.
 

Push till there are no gaps between the roll paper and both flanges.

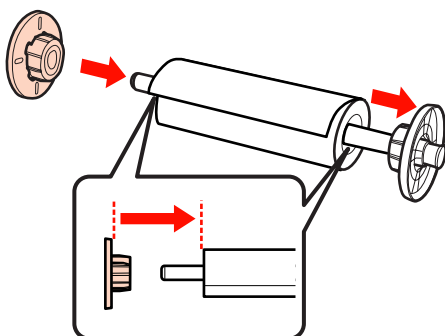

### Loading roll paper

Follow the steps below to load roll paper on the printer.



**Note:**

*Insert the paper just before printing. If the paper is left in the printer, the roller of the paper presser may leave a mark on the surface of the paper.*

- 1 Make sure the printer is on.
- 2 Check the paper source settings.
 

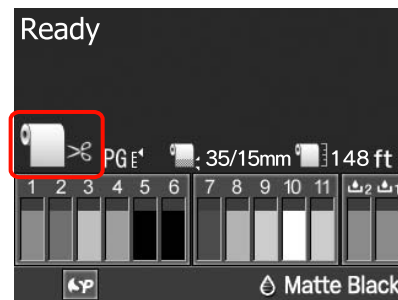
Check the paper source icon on the screen, and if it differs from the paper that you want to load, change the setting.



-  : Prints on roll paper and cuts automatically after printing each page.
-  : Prints on roll paper but does not cut after printing.
-  : Prints on cut sheets.

To change the setting, press the ◀ button. When the Paper Type menu is displayed on the screen, select **Roll Paper / Cut** or **Roll Paper / No Cut**, and then press the OK button.

- 3 Open the roll paper cover.

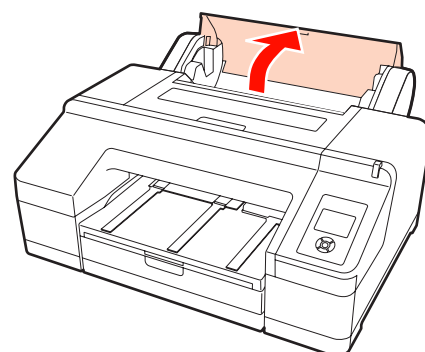

## Basic Operations

- 4** Hold with the gray flange (fixed) on the right, place both sides of the spindle into the spindle holder on the printer.

Match the colors of the spindle holder to the colors on the end of the spindle.

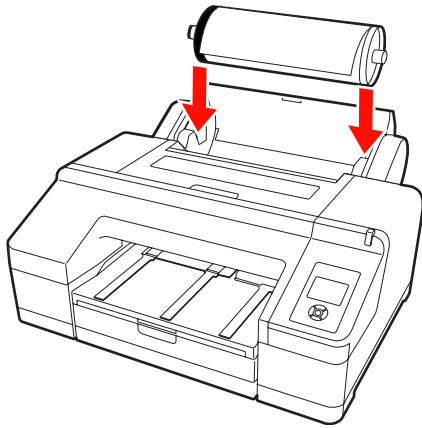

**Note:**  
If the spindle is set in the wrong direction, paper is not fed correctly.

- 5** Press the  $\frac{\%}{\%}$  button on the control panel.

**Insert paper until message on LCD panel is changed.** is displayed on the screen.

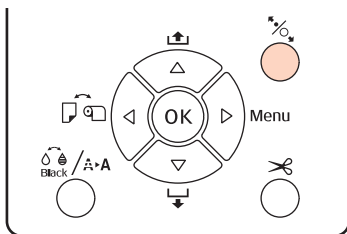

- 6** Insert the leading edge of the roll paper in the roll paper feeder.

When inserting, make sure not to fold the edge and remove any slack.

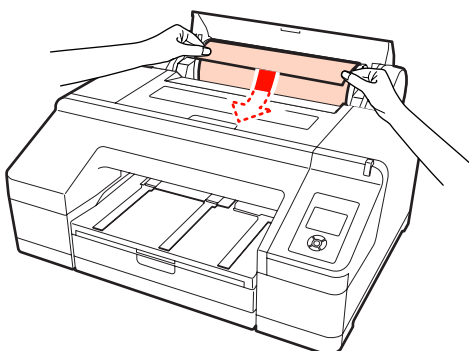

- 7** Feed the paper.

### When Auto Roll Feeding is On

When the paper is inserted a little, the screen display changes to **Press the  $\frac{\%}{\%}$  button.**

Check that the screen display has changed, and then press the  $\frac{\%}{\%}$  button to automatically feed the paper to the start position.

### When Auto Roll Feeding is Off

Insert the paper (so that the edge of the paper comes out of the front manual feeder) until the screen display changes.

Check that the screen display has changed, and then press the  $\frac{\%}{\%}$  button to automatically feed the paper to the start position.

- 8** Close the roll paper cover.

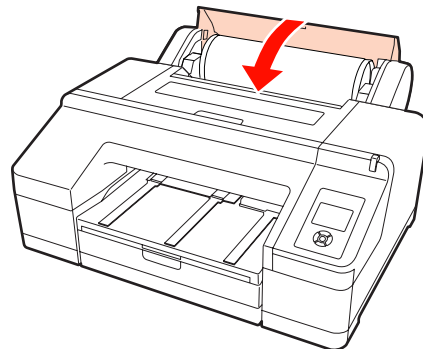

- 9** Check the media type.

**Are these settings OK?** is displayed on the screen, and the media type currently specified on the printer is displayed.

When roll paper with a barcode is loaded, the confirmation message is not displayed as the barcode is read automatically and the settings are made automatically. Go to step 10.

When the displayed media type and the loaded media type match, press the  $\blacktriangledown/\blacktriangle$  buttons to select **YES**, and then press the **OK** button.

If you want to change the media type, select **NO** and then press the **OK** button. When the Paper Type menu is displayed, select the category depending on the loaded media type, and then press the  $\blacktriangleright$  button. Select the media type, and then press the **OK** button.

## Basic Operations

10

Slide out the output tray to the second and third extensions.

Do not raise the flap. If the flap is raised while printing, the paper may not be ejected correctly.

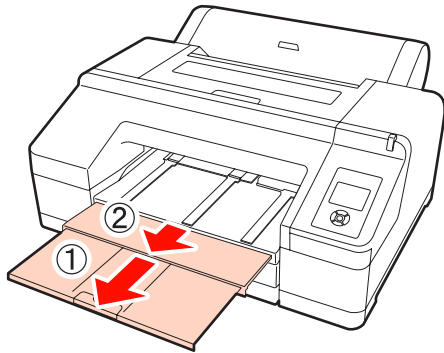
**Note:**

- ❑ The output tray can only hold one sheet of roll paper at a time. Remove each sheet of roll paper as it is ejected without letting the sheets stack up on the output tray. Also, do not allow cut sheets and roll paper to stack up together.
- ❑ Do not raise the flap when **Roll Paper / No Cut** is set from the Paper Type menu or while performing banner printing. If the flap is raised while printing, the paper may not be ejected correctly.

11

Set up the paper eject support depending on the paper type.

Set up the paper eject support when plain paper is loaded.

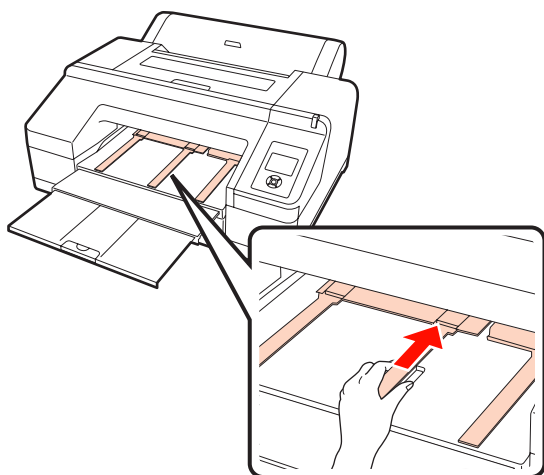
**Tip:**

When **Auto Roll Feeding** is set to **On** in the Menu, and a paper cassette is specified from the printer driver, the roll paper automatically returns to its stand by position and the cut sheet is fed and printed from the paper cassette even if roll paper was loaded on the printer; however, if roll paper is specified from the printer driver in a subsequent job, the roll paper is automatically fed and printed.

The factory setting for **Auto Roll Feeding** is **On**.

## Cutting the roll paper

After printing, you can cut the roll paper by one of the following two methods. You can specify the method either from the control panel or the printer driver. However, when printing from the printer driver, the printer driver settings are given priority regardless of the settings on the control panel.

❑ **Auto cut:**

Cut the roll paper after printing each page automatically using the built-in cutter.

❑ **Manual cut:**

Press the ✂ button to cut the roll paper with the built-in cutter, or use a cutter sold at a store.

**Tip:**

- ❑ Some of the roll paper may not be cut using the built-in cutter. Use a cutter sold at a store to cut the paper.
- ❑ It may take a while to cut the roll paper.

## Setting methods

### Setting on the computer

Set **Auto Cut** from the **Main** screen - **Roll Paper Option** in the printer driver's **Properties** (or **Print Preferences**) screen.

### Setting from the printer

Press the ◀ button on the control panel to display the Paper Type menu, and then select it.

👉 [“Control panel” on page 13](#)

## Basic Operations

### Manual cut method

If you set **Off** or **Roll Paper / No Cut** on the printer driver or control panel, you can cut the paper after printing using the following procedure.

- 1 While watching the inside of the printer through the window in the printer cover, press the ▼ button to feed the roll paper and adjust the cutting position to the ←✂ mark on the inside of the printer on the right-hand side.

**Tip:**

The minimum length of paper you can cut with the built-in cutter is fixed to 80 or 127 mm and cannot be changed. The length is 210 mm when the optional SpectroProofer is installed. If the cutting position is shorter than the shortest length above, the paper has to be automatically fed to that length thus a margin will have to be left. Cut off the margin with a cutter sold at a store.

- 2 Press the ✂ button. When the confirmation message is displayed on the screen, use the ▼ button to select **Cut**, and then press the OK button.

The paper is cut by the built-in cutter.

**Tip:**

If the roll paper cannot be cut by the built-in cutter, press the ▼ button to feed the paper to a position where you can cut it manually.

### Removing the roll paper

Remove the roll paper from the printer after printing and store it. If the roll paper is left in the printer, the roller of the paper presser may leave a mark on the surface of the paper.

- 1 Make sure the printer is on.

- 2 Open the roll paper cover.

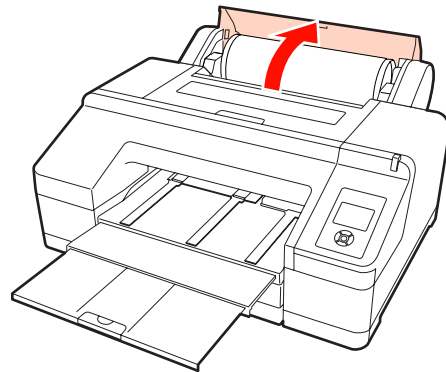

- 3 Press the ⏸ button to release the paper presser.

The roll paper is rewound automatically after cutting or if it is standing by. The printer starts to print a barcode if **Remaining Paper Setup** is set to **On** from the Menu. When barcode printing is complete, the paper rewinds.

If it does not rewind automatically, rotate the flanges in the opposite direction to rewind.

**Note:**

Press the ⏸ button when removing the roll paper.

If you do not press the ⏸ button when removing the roll paper, the barcode is not printed even if **Remaining Paper Setup** is set to **On** from the Menu, and you cannot manage the roll paper information.

- 4 Hold both ends of the spindle and lift up from the spindle holder.

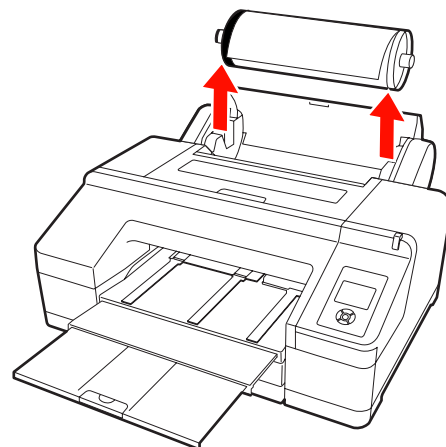



## Basic Operations

**Note:**

Always check that the roll paper is rewound before removing the spindle.

If the roll paper is not rewound, the spindle may be locked. If you try to remove the spindle when it is locked, the printer could be damaged.

**Tip:**

When removing the roll paper, you can use the optional roll paper belt to prevent the roll paper from unwinding.

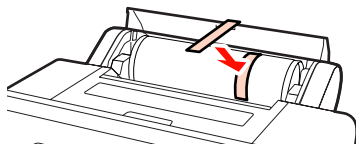

**5**

Remove the black flange from the spindle.

While holding the black flange as shown in the illustration, push the end of the spindle to pop the flange off the spindle.

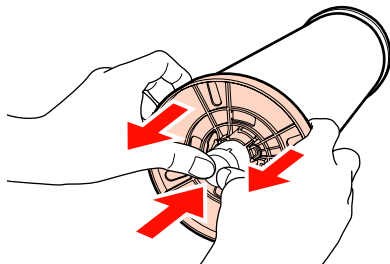

If the flange does not come off easily, lightly tap the end of the spindle on the black flange side.

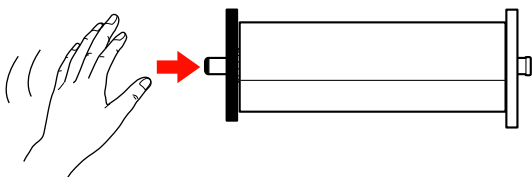

When removing a flange from the spindle while only the paper core is left on it, hold the core and push the spindle.

**Note:**

When removing the roll paper, do not knock the right side of the spindle (the gray flange side) hard against the floor.

The right side of the spindle may be damaged by the impact.

**6**

Remove the roll paper from the spindle.

After rewinding the roll paper carefully, store it in the original package.

If you are not loading another roll paper, attach the black flange to the spindle, load it in the printer, and then close the roll paper cover.

## Basic Operations

## Loading Cut Sheets

You can load cut sheets using the following three methods.

**Note:**

*If the paper is wavy or curled, flatten the paper before loading it in the printer, or use new paper. If wavy or curled paper is loaded, this printer may not be able to recognize the paper size, feed the paper, or print correctly.*

*We recommend that you return the paper to its original package and store it flat, and take it out of the package just before you use it.*

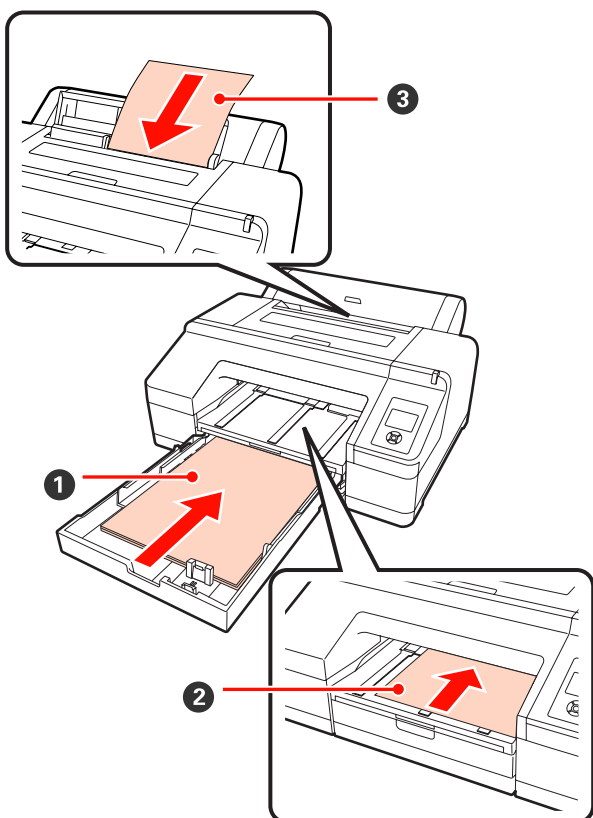

### 1 Paper cassette

You can load a stack of paper if you normally print on the same paper, or you are printing multiple pages of the same paper. You can load paper with the following specifications.

Size : 8 x 10 inch to A2

Width : 203 to 432 mm (8 to 17 inch)

Length : 254 to 594 mm (10 to 23.4 inch)

Thickness : 0.08 to 0.27 mm

How to load [“Loading the Paper Cassette” on page 35](#)

### 2 Front manual feed (loading thick paper)

You can load thick paper with the following specifications from the front feeder. However, you cannot feed from the front feeder when the optional SpectroProofer is installed.

Size : 8 x 10 inch to A2

Width : 203 to 432 mm (8 to 17 inch)

Length : 254 to 610 mm (10 to 24 inch)

Thickness : 0.8 to 1.50 mm

How to load [“Loading and Ejecting Thick Paper” on page 40](#)

### 3 Rear manual feed

You can load cut sheets with the following specifications manually one by one. Use this feeding method when printing a single page whose media type or paper size is different from the ones loaded in the paper cassette.

Size : 8 x 10 inch to A2

Width : 203 to 432 mm (8 to 17 inch)

Length : 254 to 610 mm (10 to 24 inch)

Thickness : 0.08 to 0.79 mm

How to load [“Loading Manually from the Rear” on page 39](#)

## Basic Operations

### Space at the rear

When loading thick paper or printing from the paper cassette with the optional SpectroProofer installed, paper is ejected once from the rear of the printer before printing. Therefore, make sure the following space is secured. If the printer is set up near a wall, make sure there is enough space at the rear.

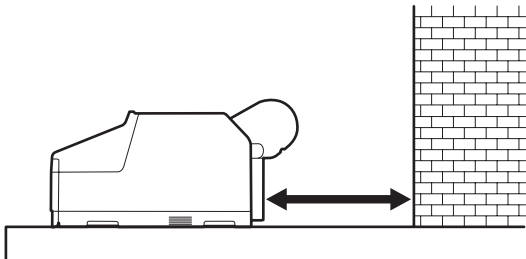

Paper Size	Rear Space
A2	Approx. 370 mm
Super A3	Approx. 260 mm
A3	Approx. 200 mm
A4	Approx. 70 mm

## Loading the Paper Cassette

**Note:**

- Do not remove or insert the paper cassette while printing. It may cause print quality to decline or cause a paper jam.

If you remove the paper cassette while printing, wait until printing is complete to reinsert it.

- When loading paper in the paper cassette, always remove the paper cassette from the printer and follow the steps below. If paper is loaded while the paper cassette is still in the printer, it could cause print quality to decline or cause a paper jam.

**Tip:**

Some paper types cannot be printed from the paper cassette. ☞ [“Epson Special Media Table” on page 153](#)

Use the front manual feed or rear manual feed method for these papers.

1

Remove the output tray.

Lift the edge of the output tray slightly to remove it.

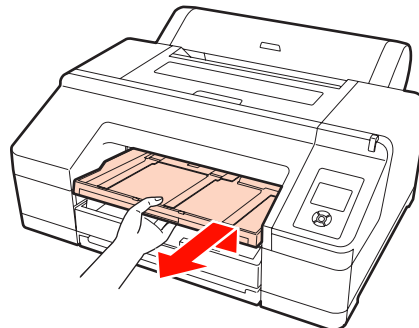

2

Slide out the paper cassette, and then hold both sides of the cassette to pull it out.

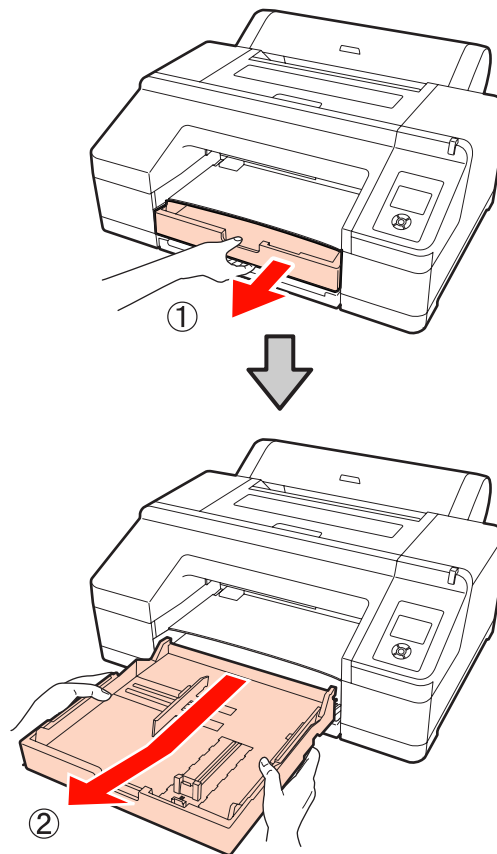

Basic Operations

- 3** When loading super A3 or larger paper, extend the paper cassette to match the size of the paper.

When loading A3 or smaller paper, go to step 5 because the paper cassette does not need to be extended. Whether or not the paper cassette is extended, the procedure for loading paper after step 5 is the same.

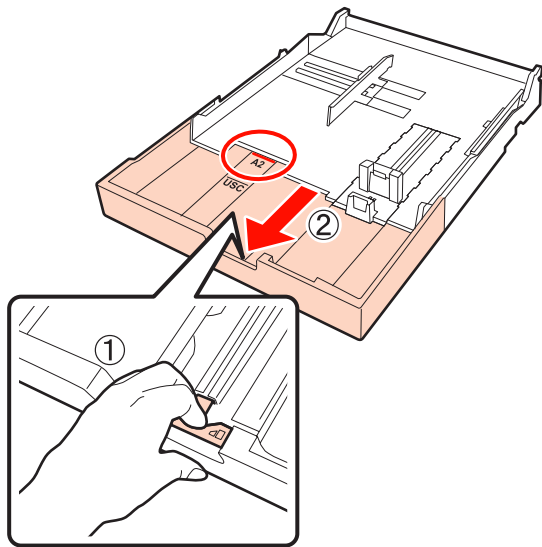

When extending the paper cassette, pull the lever in the paper cassette while extending. It locks in place when the lever is released.

Extend it to a position to match the size of the paper you want to load according to the stamps in the paper cassette.

- 4** Expand the slider.

Make sure you move the slider to the edge of the paper cassette.

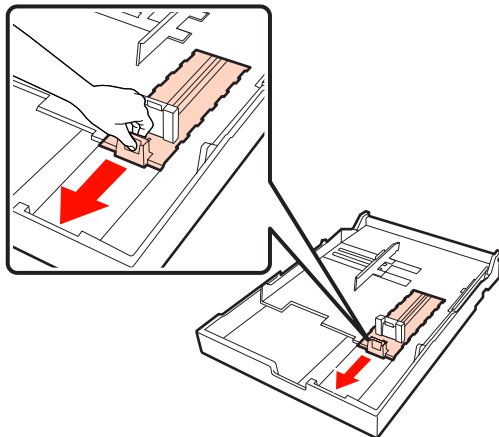

- 5** Expand the edge guide.

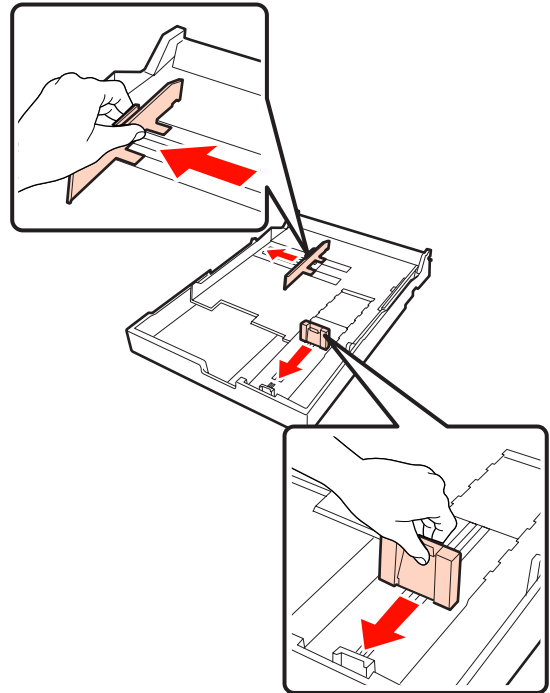

- 6** Fan the paper you want to load three times on each side before loading.

When loading paper into the paper cassette, be sure to fan paper for the front and rear three times on each side.

Number of sheets that can be loaded "Cut sheet" on page 154

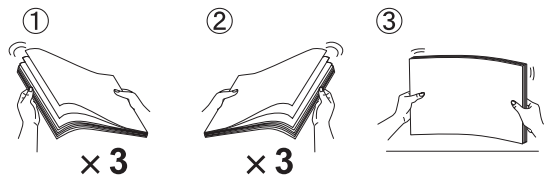

- 7** Load paper in the paper cassette with the printable side face down.

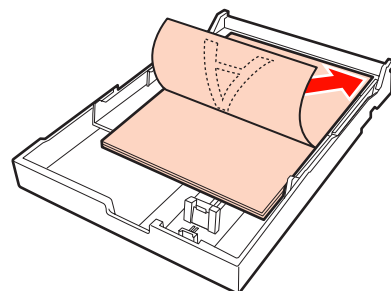

**Basic Operations**

**Tip:**

❑ You can load up to 250 sheets (thickness 0.1 mm) of plain paper in the paper cassette.

If paper is loaded above the edge guide mark (▼), paper cannot be fed correctly. The maximum number of sheets you can load in the paper cassette differs depending on the paper type. See the following for more information on the maximum number of sheets for Epson special media.

📄 “Cut sheet” on page 154

❑ We recommend refilling the paper cassette once paper has completely run out, rather than adding on top of ones already in the cassette.

**8** Fit the edge guide to the edge of the paper.

Move the edge guide without moving the slider.

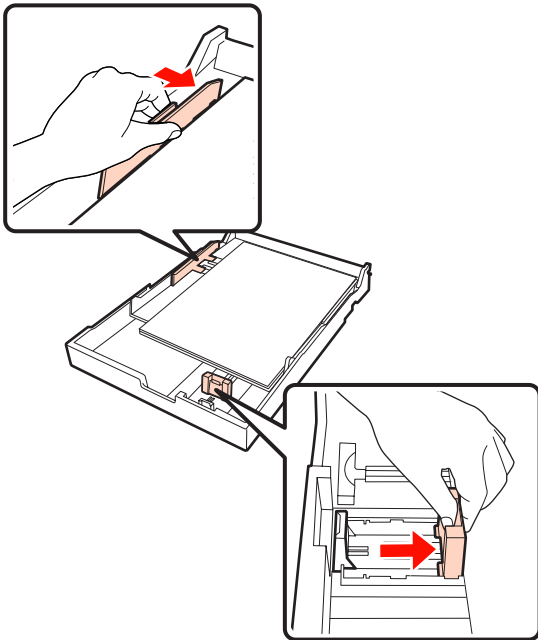

**9** Insert the paper cassette.

Push it firmly into the printer.

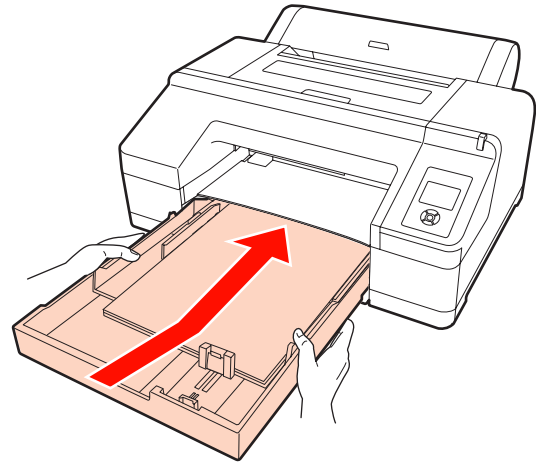

**10** Attach the output tray.

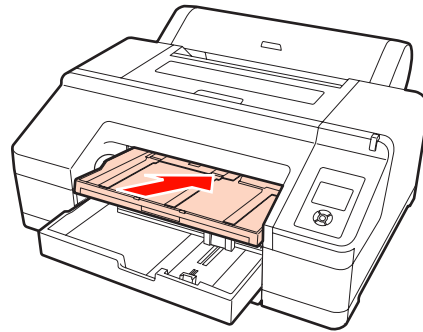

**11** Extend output tray to suit the paper size and raise the flap.

Adjust the output tray as follows depending on the size of the paper loaded in the paper cassette.

**Basic Operations**

**For A4**

Slide out the third extension of the output tray, raise the flap, and then push the section back in.

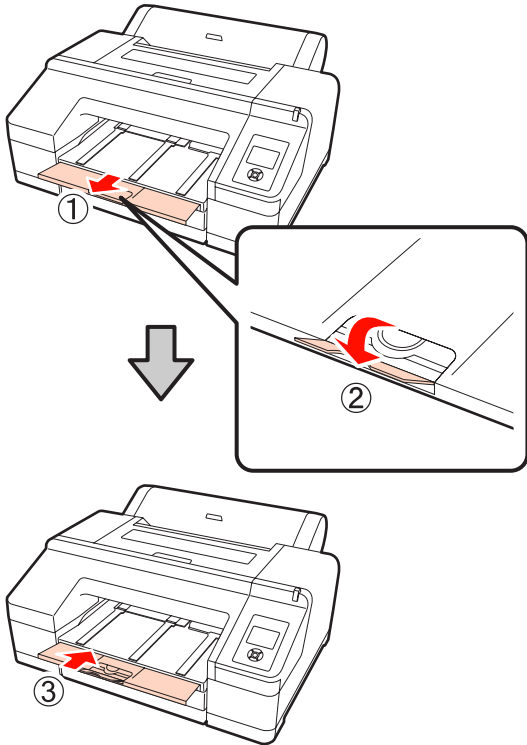

**For A3**

Pull out the third section of the output tray, and then raise the flap.

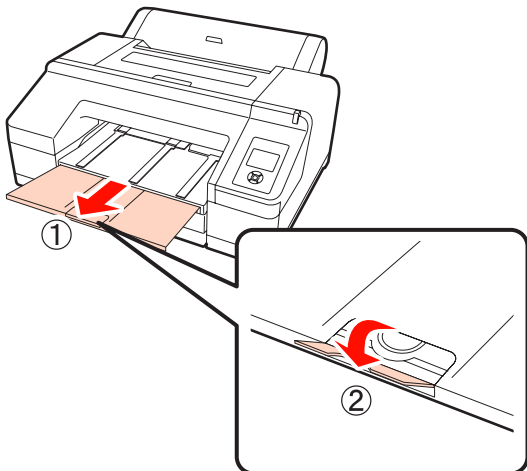

**For super A3 or larger**

Slide out the second and third extensions of the output tray, and then raise the flap. Make sure that you align the marks on the second extension of the output tray and the paper cassette.

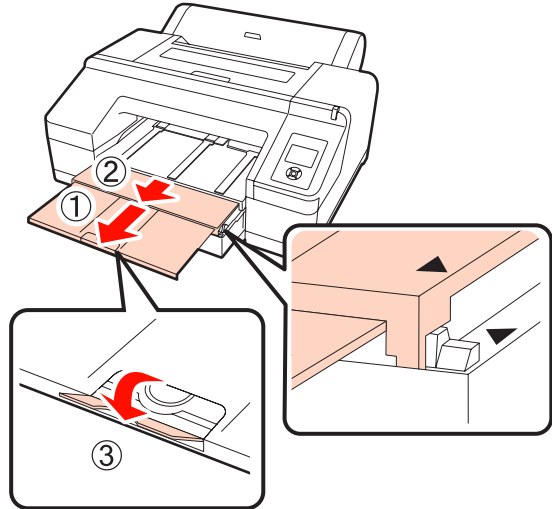

**Note:**

The output tray can hold up to 50 ejected cut sheets. However, when the number of sheets that can be loaded in the paper cassette is less than 50, the maximum number the output tray can hold is the same as the number of sheets in the paper cassette. Do not allow more than 50 cut sheets to stack up on the output tray. Also, do not mix roll paper and cut sheets on the output tray.

When the optional SpectroProofer is installed, remove each sheet as it is printed regardless of the size. If multiple sheets stack up on the output tray, color measurement accuracy may decline.

**Tip:**

Except when installing the optional SpectroProofer, check that the paper eject support is lowered. If the paper eject support is raised, lower it before printing.

**12**



Make sure the printer is on.

Basic Operations

13 Check the paper source settings.

Check the paper source icon on the screen, and if it differs from the paper that you want to load, change the setting.



-  : Prints on roll paper and cuts automatically after printing each page.
-  : Prints on roll paper but does not cut after printing.
-  : Prints on cut sheets.

To change the setting, press the ◀ button. When the Paper Type menu is displayed on the screen, select **Cut Sheet** and then press the OK button.

**Tip:**

When **Auto Roll Feeding** is set to **On** in the Menu, and a paper cassette is specified from the printer driver, the roll paper automatically returns to its stand by position and the cut sheet is fed and printed from the paper cassette even if roll paper was loaded on the printer;

however, if roll paper is specified from the printer driver in a subsequent job, the roll paper is automatically fed and printed.

The factory setting for **Auto Roll Feeding** is **On**.



**Loading Manually from the Rear**

1 Make sure the printer is on.

2 Check the paper source settings.

Check the paper source icon on the screen, and if it differs from the paper that you want to load, change the setting.



-  : Prints on roll paper and cuts automatically after printing each page.
-  : Prints on roll paper but does not cut after printing.
-  : Prints on cut sheets.

To change the setting, press the ◀ button. When the Paper Type menu is displayed on the screen, select **Cut Sheet** and then press the OK button.

3 Raise the paper support.

Extend the paper support when loading A3 or larger paper.

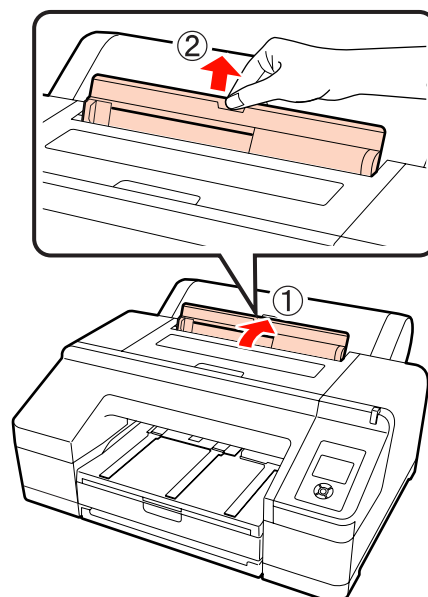

## Basic Operations

- 4** Set the edge guide according to the width of the paper you want to load.

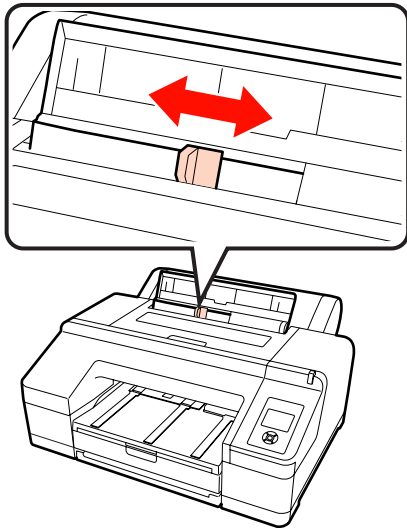

- 5** Insert the paper into the rear manual feeder with the printable side face up as shown in the illustration.

Insert the paper until it reaches the bottom.

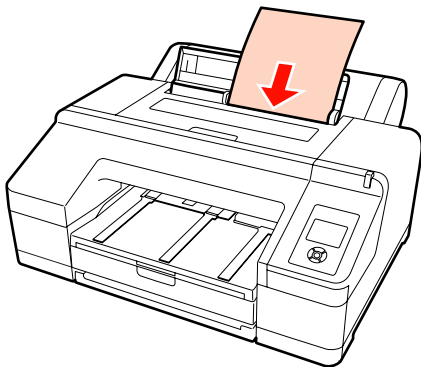

- 6** Check that the leading edge of the paper is inserted as far as the gray roller inside the printer. Press the ▼ button to feed the paper.

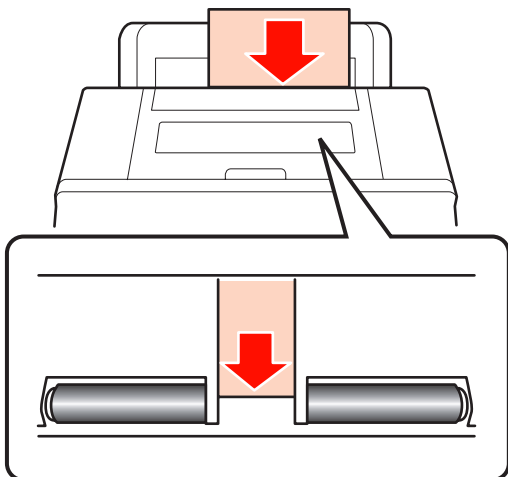

- 7** Slide out the output tray to the second and third extensions.

Do not raise the flap. If the flap is raised while printing, the paper may not be ejected correctly.

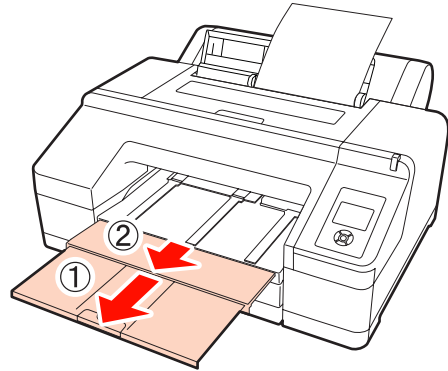

**Note:**

Remove each sheet of paper as it is ejected without letting the sheets stack up on the output tray.

**Tip:**

Except when installing the optional SpectroProofer, check that the paper eject support is lowered. If the paper eject support is raised, lower it before printing.

## Loading and Ejecting Thick Paper

**Note:**

When the optional SpectroProofer is installed, you cannot print from the front manual feeder.

### How to load

- 1** Make sure the printer is on.





## Basic Operations

### 2 Check the paper source settings.

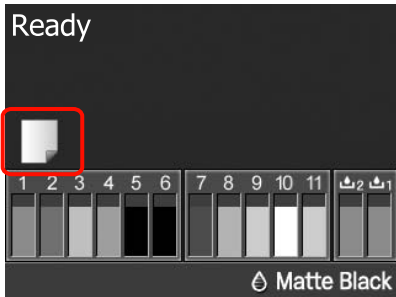
Check the paper source icon on the screen, and if it differs from the paper that you want to load, change the setting.



 : Prints on roll paper and cuts automatically after printing each page.

 : Prints on roll paper but does not cut after printing.

 : Prints on cut sheets.

To change the setting, press the ◀ button. When the Paper Type menu is displayed on the screen, select **Cut Sheet** and then press the OK button.

### 3 Press the button to release the paper presser.

**Insert paper until its edge aligns with line on output tray.** is displayed on the screen.

### 4 Insert the paper with the printable side face up over the black roller in the front manual feeder as shown in the illustration.

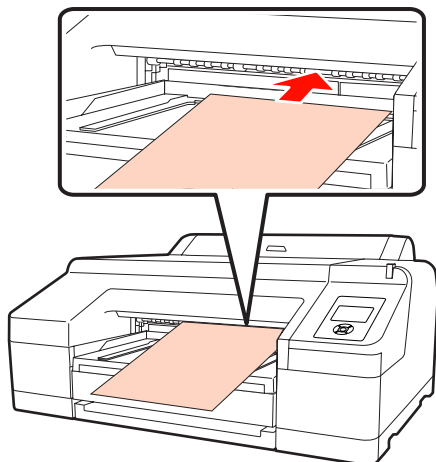

### 5 Open the printer cover.

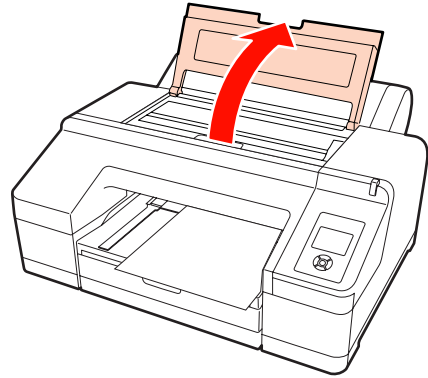

### 6 Insert the paper under the gray roller inside the printer.

Do not touch any of the internal printer parts as you insert the paper.

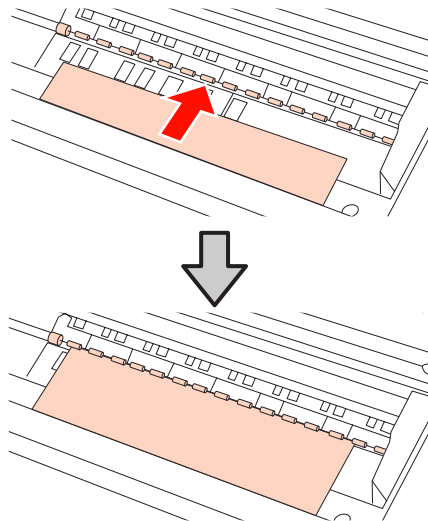

### 7 Close the printer cover.

## Basic Operations

- 8** Insert the paper and align its edge with the guide line on the output tray.

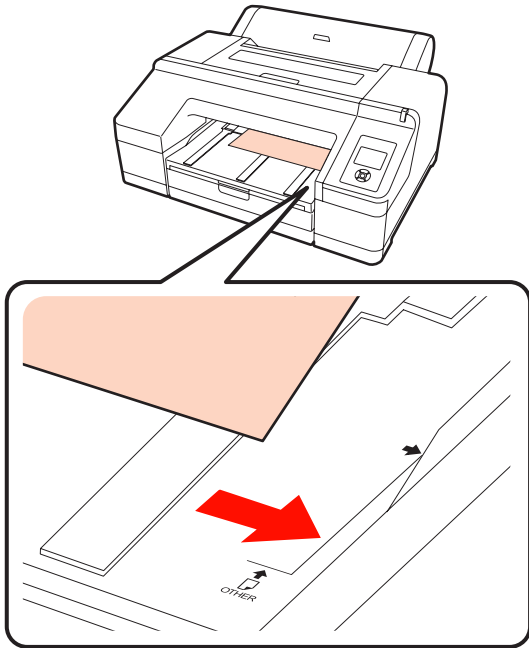

- 9** Feed the paper.

When the paper is inserted, the screen display changes to **Press the % button**.

Check that the screen display has changed, and then press the % button to automatically feed the paper to the start position.

- 10** Slide out the output tray to the second and third extensions.

Do not raise the flap. If the flap is raised while printing, the paper may not be ejected correctly.

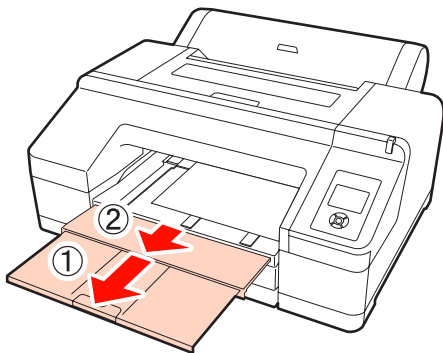

**Note:**

The output tray can only hold one piece of thick paper at a time. Remove each sheet of thick paper as it is ejected without letting the sheets stack up on the output tray.

**Tip:**

If the paper eject support is raised, lower it before printing.

### How to eject

Thick paper is held by the paper presser after printing. Follow the steps below to eject paper.

- 1** Check that **Press the % button** is displayed on the screen.
- 2** Press the % button to release the paper presser, and then pull out the paper.

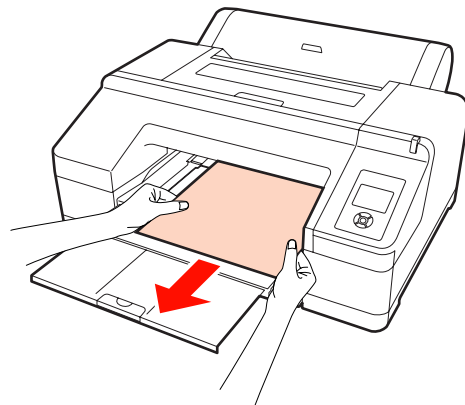

- 3** After removing the paper, press the % button.

## Basic Operations

## Basic Printing Methods (Windows)

You can make print settings such as paper size and paper feed from the connected computer and then print.

- 1 Turn on the printer, and load the paper.

 “Loading Cut Sheets” on page 34

 “Loading Roll Paper” on page 27

- 2 When you have created the data, click **Print** from the **File** menu.

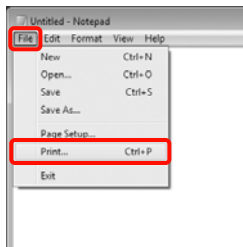

- 3 Make sure your printer is selected, and then click **Preferences** or **Properties** to display the settings screen.

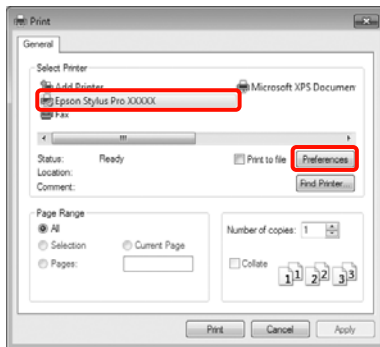

- 4 Select the **Media Type**, **Color**, **Print Quality**, and **Source** according to the paper loaded in the printer.

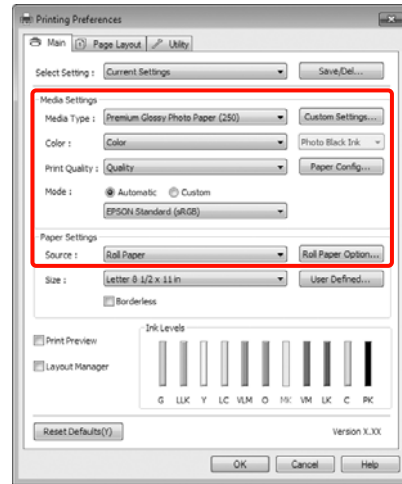

- 5 Make sure you select the same **Size** as you set in the application.

After making the settings, click **OK**.

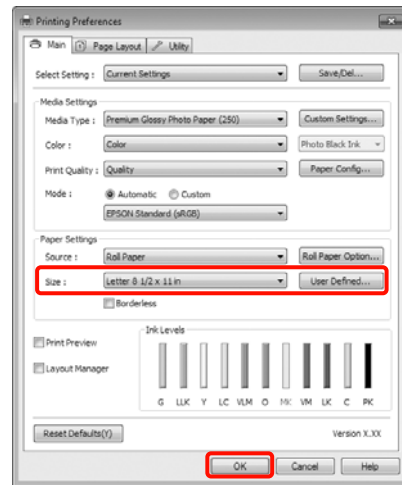

- 6 When settings are complete, click **Print**.

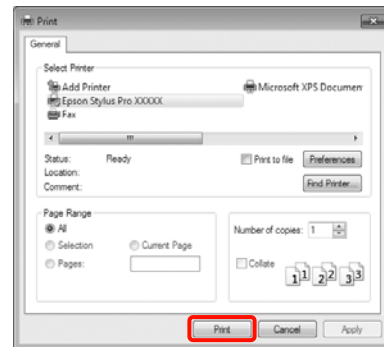

The Progress Bar is displayed, and printing starts.

## Basic Operations

### Screen while printing

The following screen is displayed when you start printing, and the Progress Bar (the computer's processing status) is displayed. On this screen you can check the remaining ink level, product numbers for the ink cartridges, and so on.



An error message is displayed if an error occurs or an ink cartridge needs replacing while printing.

Click **How to**, to find out how to solve the problem.

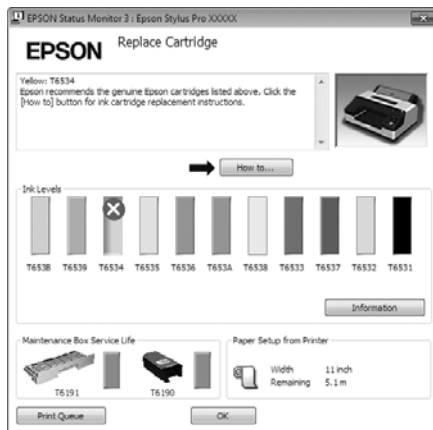

## Basic Printing Methods (Mac OS X)

1 Turn on the printer, and load the paper.

[“Loading Cut Sheets” on page 34](#)

[“Loading Roll Paper” on page 27](#)

2 When you have created the data, from the **File** menu of the application, click **Print** and so on.

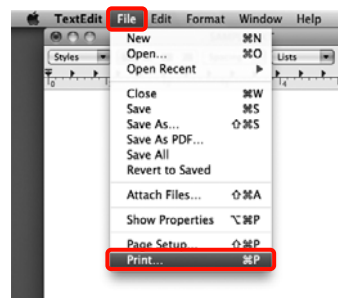

3 The print screen is displayed.

For Mac OS X 10.6 and 10.5, click the arrow () to make settings on the Page Setup screen.

For Mac OS X v10.7, click **Show Details** at the bottom of the screen.

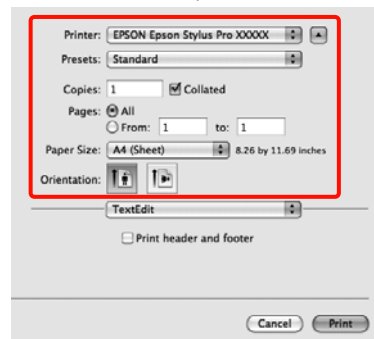
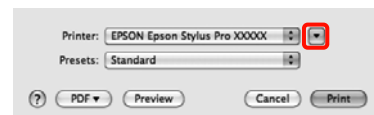

**Basic Operations**

**Tip:**

When using Mac OS X 10.4, or if items on the Page Setup screen are not displayed on the Print screen due to the application being used in Mac OS X 10.7, 10.6, or 10.5 follow the steps below to display the Page Setup screen.

From the **File** menu of the application, click **Page Setup**.

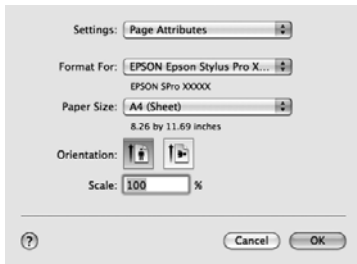

**4** Check that this printer is selected, and then set the paper size.

In **Paper Size**, select either of the following depending on the loaded paper. XXXX is the actual paper size, such as A4.

XXXX: Print with margins on roll paper. Prints using the margin set in **Roll Paper Margin** from the Menu. [Printer Setup menu](#) on page 103

XXXX (cut sheet): Print with margins on cut sheets. Margins are 3 mm on the top, left, and right, and 14 mm on the bottom.

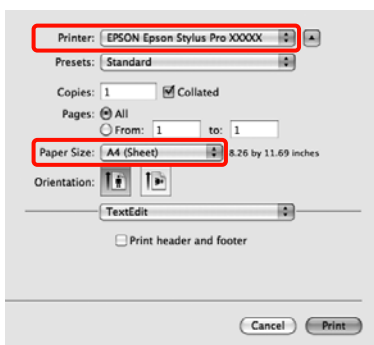

When performing borderless or banner printing [Borderless printing](#) on page 68, [Banner printing \(on roll paper\)](#) on page 86

**5** Select **Print Settings** from the list, and then set each item.

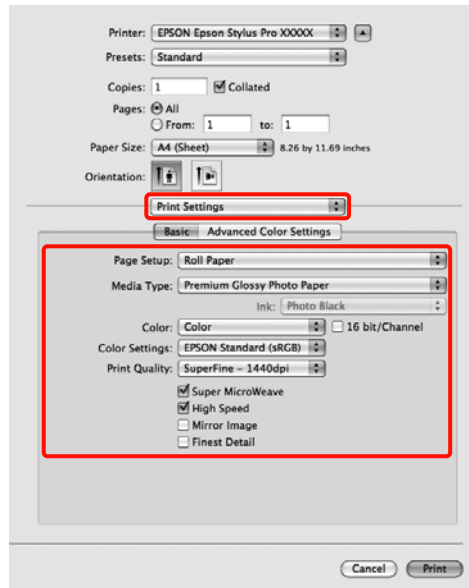

Set the **Media Type**, **Color**, or **Print Quality** according to the paper feed method for the paper loaded in the printer (for cut sheets). Normally, you can print correctly just by setting items in the **Print Settings** screen.

**6** When settings are complete, click **Print**.

The printer icon is displayed in the Dock while printing. Click the printer icon to display the status. You can check the progress of the current print job and the printer status information. You can also cancel a print job.

Also, if an error occurs while printing, a notification message is displayed.



Basic Operations

# Printable area

This section describes the printable areas for the printer.

If the margin set in an application is larger than the following setting values, sections beyond the specified margins are not printed. For example, if left and right margins are set to 15 mm in the Menu and an application attempts to print data to the full width, 15 mm strips on both sides are not printed.

## Roll Paper Printable Area

The gray area in the illustration below shows the printable area.

When printing borderless on the left and right, the left and right margins are 0 mm. When printing borderless on all edges, all margins are 0 mm.

The arrow in the illustration indicates the direction of the ejected paper.

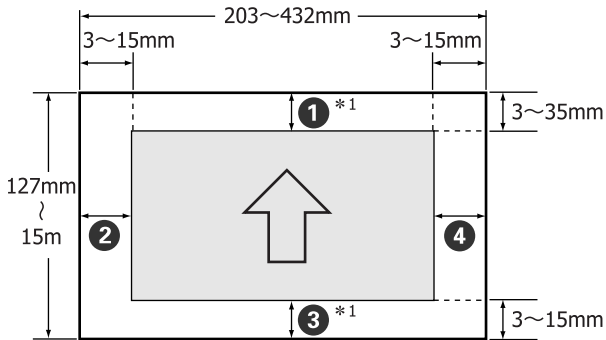

The margins for roll paper differ as shown below, depending on the **Roll Paper Margin** setting in the Menu.

**Roll Paper Margin** Settings "Printer Setup menu" on page 103

The factory setting is .

Roll Paper Margin Parameter	Margin Values
Default	<p>①, ③ = 15 mm*2</p> <p>②, ④ = 3 mm</p>
Top/Bottom 15mm	<p>①, ③ = 15 mm</p> <p>②, ④ = 3 mm</p>

Roll Paper Margin Parameter	Margin Values
Top 35/Bottom 15mm	<p>① = 35 mm</p> <p>③ = 15 mm</p> <p>②, ④ = 3 mm</p>
3mm	①, ②, ③, ④ = 3 mm
15mm	①, ②, ③, ④ = 15 mm

- \*1 Selecting **Roll Paper (Banner)** in the printer driver sets the top and bottom margins of the paper to 0 mm.
- \*2 When **Default** is selected, the value for ① is 20 mm for the following paper.

Premium Glossy Photo Paper (250)/Premium Semigloss Photo Paper (250)/Premium Luster Photo Paper (260)/Premium Semimatte Photo Paper (260)

**Note:**

- Printing is distorted when the trailing edge of the roll paper comes off the core. Make sure the trailing edge does not come inside the printing area.
- The print size does not change even when the margins are changed.

## Cut Sheets Printable Area

When printing borderless on the left and right, the left and right margins are 0 mm.

The arrow in the illustration indicates the direction of the ejected paper.

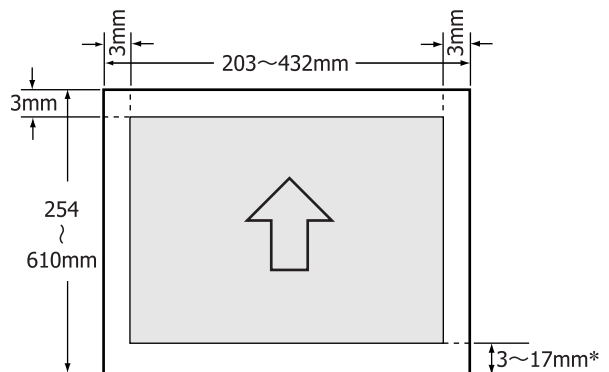

## Basic Operations

- \* When printing with margins the default value is 14 mm.

The default value for the bottom margin is 17 mm when printing borderless on the left and right.

## Changing the Type of Black Ink

This printer allows you to set both photo black ink and matte black ink and switch between them depending on the paper type.

Photo Black ink reduces the grainy feeling of photo papers giving them a smooth, professional finish. Matte Black ink significantly increases black optical density when printing on matte type papers.



See the following section to select a suitable black ink for the media type.

 [“Epson Special Media Table” on page 153](#)

### Changing the type of ink on the printer



It takes approximately 2 to 3 minutes to switch the black ink type (from ink replacement until ink charging is complete).

Also, when switching black inks, approximately 2 to 4 ml of the black ink being changed to is consumed. Do not switch the black ink unless necessary.

- 1 Turn on the printer by pressing the  button.
- 2 Press the  button to display the Ink Menu.

**Tip:**

*If the  button is pressed while printing is paused, you cannot switch the type of black ink. **Change Black Ink** is not displayed on the menu.*

- 3 Press the / buttons to select **Change Black Ink**, and then press the OK button.
- 4 The name of the black ink to be switched to is displayed based on the current settings. Press the OK button.

After switching is complete, the Menu closes. Make sure that the type of black ink has changed at the bottom right on the screen.

## Basic Operations

### Changing from the printer driver

Normally, the required type of black ink is specified from the printer's Ink Menu. However, when printing on paper that is compatible with both types of black ink, you can perform the following procedure to automatically switch the type of black ink from the printer driver.

When printing on paper that is only designed for a certain type of black ink, you need to set the type of black ink for the paper in the printer's Ink Menu in advance.

- 1 Set **Change Black Ink** to **Auto** in the Menu.

If **Change Black Ink** is set to **Auto**, you can automatically switch black ink from the printer driver.

The factory setting is **Off**.  [“Printer Setup menu” on page 103](#)

- 2 Display the printer driver's **Main** screen (Windows) or **Print Settings** screen (Mac OS X).

- 3 After selecting the paper type from **Media Type**, select the black ink you want to use.

### Windows

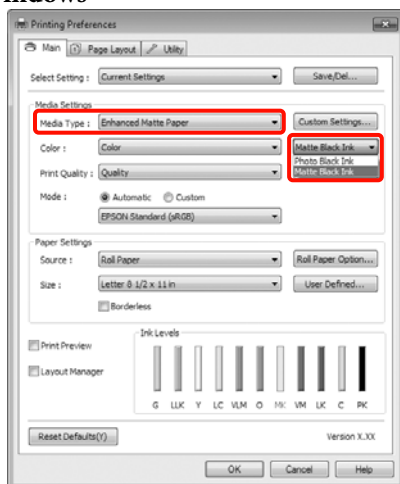

### Mac OS X

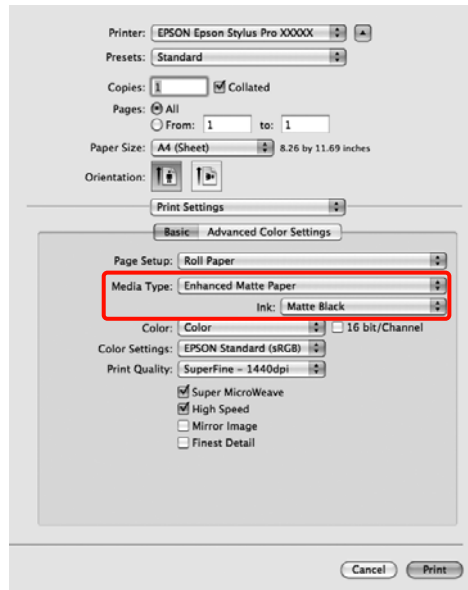

- 4 Check other settings, and then start printing.





## Turning Off the Power Using Power Management

This printer comes equipped with the following two types of power saving settings. You can save power by transitioning into sleep mode or use the Power Management function to automatically turn off the power when the printer has not been used for a certain period of time.

### ❑ Sleep mode

The printer enters sleep mode when there are no errors, no print jobs being received, and no control panel or other operations performed. When the printer enters sleep mode, the control panel's screen turns off and the internal motors and other parts switch off to consume less power.

Press any button on the control panel (except for the  button) to display the control panel's screen. However, under these conditions, the screen display turns off again after 30 seconds if no operations are performed.

The printer comes out of sleep mode completely and resumes its normal status only when it needs to perform hardware operations, for example, when it receives a print job, or if you press the  button after recovering the screen display. You can select the time to sleep mode from **5 minutes**, **15 minutes**, **60 minutes**, **120 minutes**, and **180 minutes**. At the factory settings, the printer enters sleep mode if no operations are performed for 15 minutes. You can change the time required before entering sleep mode in the Maintenance Mode menu.  [“Maintenance Mode List” on page 160](#)

#### **Tip:**

*When the printer enters sleep mode, the control panel's screen goes blank as if the power has been turned off, but the  light remains lit.*

### ❑ Power Management

The printer includes a Power Management function that allows the printer to be turned off automatically if there are no errors, no print jobs being received, and no control panel or other operations being performed for more than the specified amount of time. In the **Power**

**Management** setting, you can specify the elapsed time before the printer is automatically turned off in hours within a range of 1 to 24.

At the factory setting, the printer turns off automatically when there are no errors, no print jobs being received, and no control panel or other operations are performed for eight hours. You can change Power Management settings from the Maintenance Mode menu.  [“Maintenance Mode List” on page 160](#)

Basic Operations

# Canceling Printing

There are a few ways to stop printing operations depending on the situation.

When the computer has finished sending data to the printer, you cannot cancel the print job from the computer. Cancel on the printer.

## Canceling from the computer (Windows)

**When the Progress Bar is displayed**  
Click **Stop**.

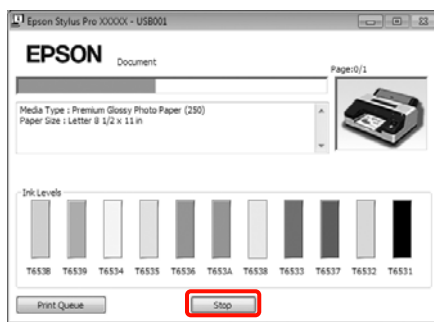

**When the Progress Bar is not displayed**

- 1 Click the printer icon on the Taskbar.
- 2 Select the job you want to cancel, and then select **Cancel** from the **Document** menu.

When you want to cancel all jobs, select **Cancel All Documents** from the **Printer** menu.

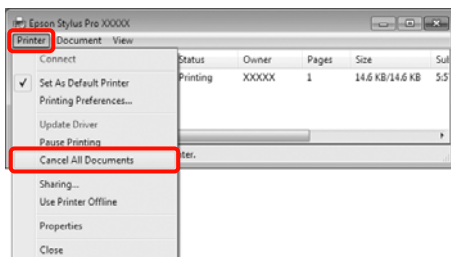

If the job has been sent to the printer, print data is not displayed on the above screen.

## Canceling from the computer (Mac OS X)

- 1 Click the printer icon in the Dock.



- 2 Select the job you want to cancel, and then click **Delete**.

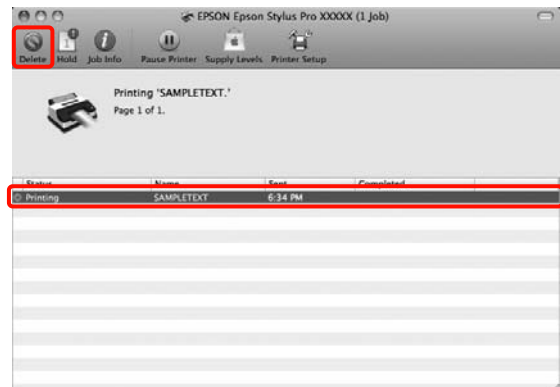

If the job has been sent to the printer, print data is not displayed on the above screen.

## Canceling on the printer

Press the **II** button, select **Job Cancel** on the screen, and then press the **OK** button.

The print job is canceled even in the middle of printing. It may take a while before the printer returns to ready status after canceling a job.

**Tip:**

*You cannot delete print jobs which are in the print queue on the computer using the above operation. See "Canceling from the computer" to delete print jobs in the print queue.*

Using the Printer Driver(Windows)

# Using the Printer Driver (Windows)

## Displaying the Settings Screen

You can access the printer driver in the following ways:

- ❑ From Windows applications

 [“Basic Printing Methods\(Windows\)” on page 43](#)

- ❑ From the Printer icon

### From the Printer icon

Follow the steps below when specifying common settings among applications or performing printer maintenance, such as Nozzle Check or Head Cleaning.

- 1 Open the **Printers** or **Printers and Faxes** folder.

#### For Windows 7

Click  and then **Devices and Printers**.

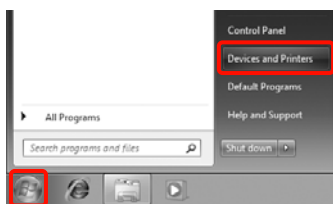

#### For Windows Vista

Click , **Control Panel**, **Hardware and Sound**, and then **Printer**.

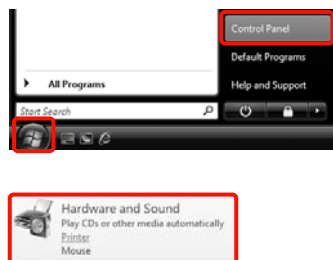

#### For Windows XP

Click **Start**, **Control Panel**, **Printers and Other Hardware**, and then **Printers and Faxes**.

**Tip:**

*If your Windows XP Control Panel is in **Classic View**, click **Start**, **Control Panel**, and then **Printers and Faxes**.*

- 2 Right-click your printer icon, and click **Printing preferences**.



The printer driver setting screen is displayed.

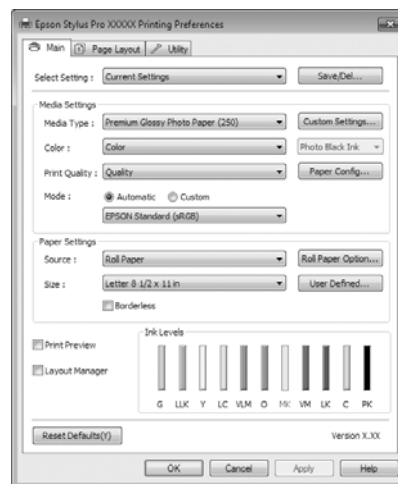

Make the necessary settings. These settings become the default settings of the printer driver.

Using the Printer Driver(Windows)

# Displaying Help

You can access the printer driver help in the following ways:

- ❑ Click **Help**
- ❑ Right-click on the item you want to check

## Click the Help Button to Display

By displaying help, you can use the contents page or keyword search to read the help.

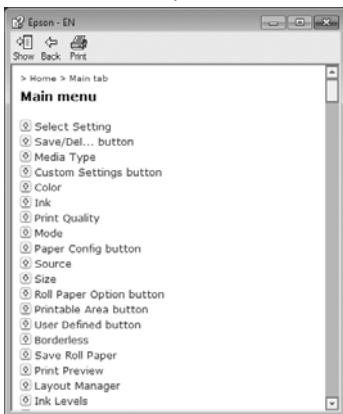
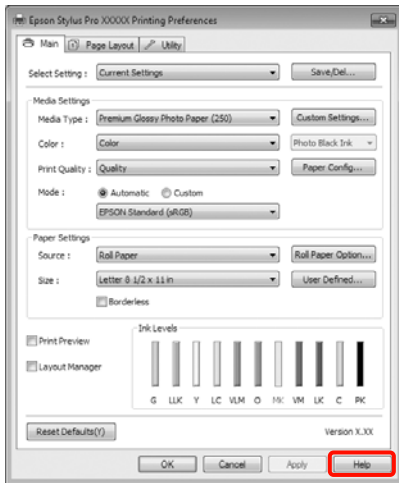

## Right-click on the item you want to check and display

Right-click the item, and then click **Help**.

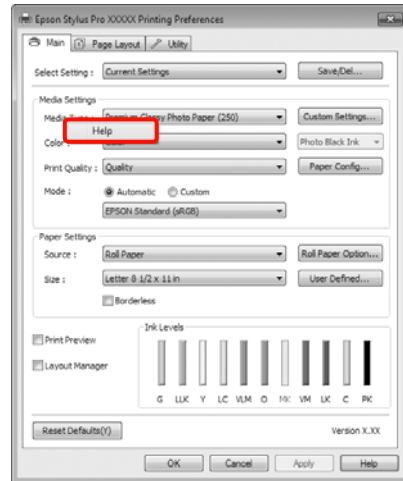

**Tip:**

In Windows XP, click  on the title bar, and then click the help item you want to view.

## Using the Printer Driver(Windows)

# Customizing the Printer Driver

You can save the settings or change the display items as you prefer.

## Saving various settings as your Select Settings

You can save all of the setting items in the printer driver.

- 1 Set each item for the **Main** screen and the **Page Layout** screen that you want to save as your **Select Settings**.
- 2 Click **Save/Del.** on the **Main** or **Page Layout** screen.

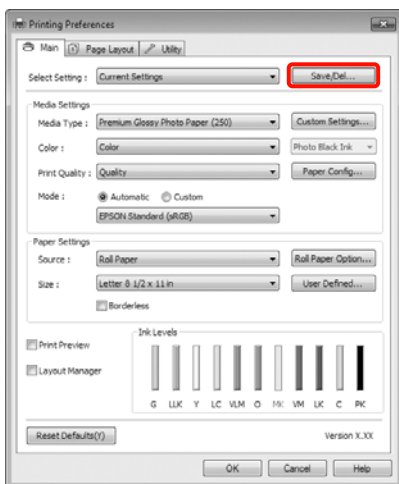

- 3 Enter any name in the **Name** box, and then click **Save**.

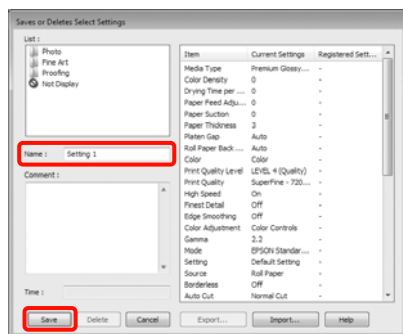

You can save up to 100 settings. You can choose a setting you have registered from the **Select Settings** list box.

### Tip:

You can save the settings as a file by clicking **Export**. You can share the settings by clicking **Import** to import the saved file on another computer.

## Saving media settings

You can save the items of the **Media Settings** on the **Main** screen.

- 1 Change the **Media Settings** items on the **Main** screen.

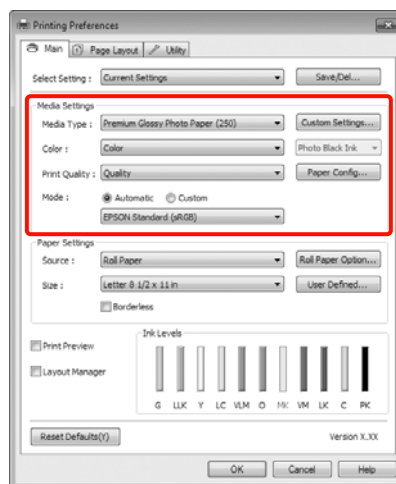

- 2 Click **Custom Settings**.

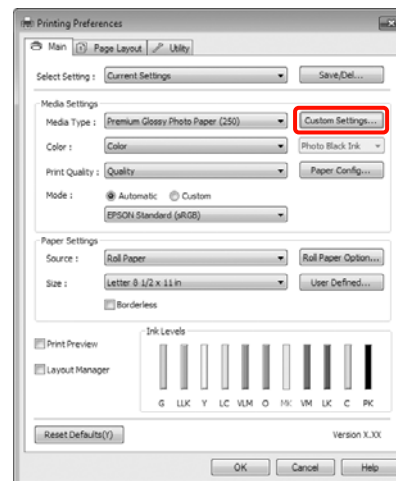

## Using the Printer Driver(Windows)

- 3** Enter any name in the **Name** box, and then click **Save**.

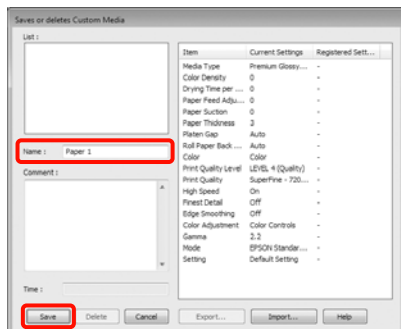

You can save up to 100 settings. You can choose a setting you have registered from the **Media Type** list box.

**Tip:**

You can save the settings as a file by clicking **Export**. You can share the settings by clicking **Import** to import the saved file on another computer.

## Rearranging display items

To display frequently used items right away, you can arrange **Select Setting**, **Media Type**, and **Paper Size** as follows.

- Hide unnecessary items.
- Rearrange in an order of most frequent use.
- Arrange in groups (folders).

- 1** Go to the **Utility** tab and click **Menu Arrangement**.



- 2** Select **Edit Item**.



- 3** Order or group items in the **List** box.

- You can move and order items by dragging and dropping.
- To add a new group (folder), click **Add Group**.
- To delete a group (folder), click **Delete Group**.
- Drag and drop unnecessary items to **Not Display**.

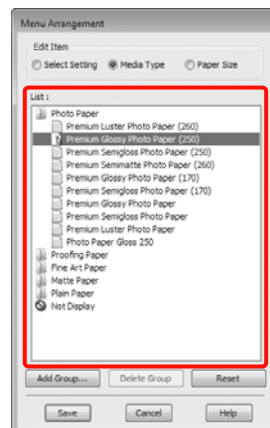

**Tip:**

When **Delete Group** is performed, the group (folder) is deleted, however the items in the deleted group (folder) remain.

- 4** Click **Save**.

## Using the Printer Driver(Windows)

# Summary of the Utility Tab

You can perform the following maintenance functions from the printer driver's **Utility** tab.



### Nozzle Check

This function prints a nozzle check pattern to check if the print head nozzles are clogged. If you see banding or gaps in the print outs, perform head cleaning to clear any clogged nozzles.

[“Cleaning the print head” on page 115](#)

### Head cleaning

If you see banding or gaps in the print outs, perform head cleaning. It cleans the surface of the print head to improve the print quality.

[“Cleaning the print head” on page 115](#)

### Print Head Alignment

If the print results appear grainy or out of focus, perform Print Head Alignment. The Print Head Alignment function corrects print head gaps.

[“Correcting Print Misalignment \(Print Head Alignment\)” on page 117](#)

### EPSON Status Monitor 3

You can check the printer's status, such as the remaining ink level and error messages, from the computer's screen.

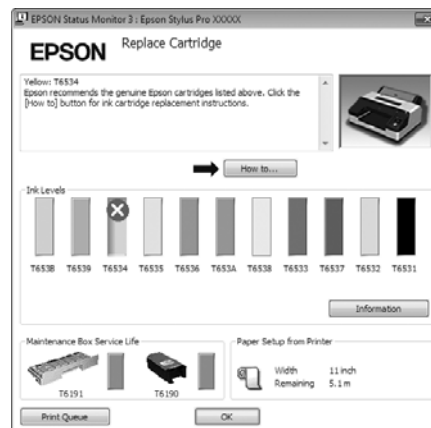

### Monitoring Preferences

You can select the error notifications displayed on the EPSON Status Monitor 3 screen, or register a shortcut for the Utility icon to the Taskbar.

#### Tip:

*If you select the **Shortcut Icon** on the **Monitoring Preferences** screen, the Utility shortcut icon is displayed on the Windows Taskbar.*

*By right-clicking the icon, you can display the following menu and perform maintenance functions.*

*EPSON Status Monitor 3 starts when the printer name is clicked from the displayed menu.*

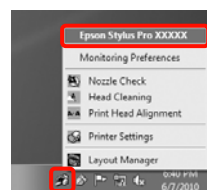

### Print Queue

You can display the list of all waiting jobs.

On the Print Queue screen, you can view information on the data waiting to be printed, delete and reprint these jobs.

### Speed and Progress

You can set various functions for printer driver basic operations.

## Using the Printer Driver(Windows)

### Menu Arrangement

You can arrange display items, **Select Setting**, **Media Type**, and **Paper Size**, for example, you can reorder them by the frequency of your access.  “Rearranging display items” on page 54

### Export or Import

You can export or import the printer driver settings. This function is useful when you want to make the same printer driver settings on multiple computers.

### EPSON LFP Remote Panel 2

You can update the printer's firmware and make custom paper settings. See the EPSON LFP Remote Panel 2 help for details.

#### Tip:

If **EPSON LFP Remote Panel 2** and **Printer Firmware Update** are grayed out, **EPSON LFP Remote Panel 2** is not installed. Install using the Software List from the Software Disc.

### Printer Firmware Update

You can update the printer's firmware to the latest version. See the EPSON LFP Remote Panel 2 help for details.

### Printer Linearization

Installing the Printer Linearization utility supplied with this printer enables this function. You can then use the optional SpectroProofer to perform high-accuracy color calibration, or perform standard color calibration using the printer's built-in sensor. For more details, see the Printer Linearization help.

You can also perform similar calibrations if the SpectroProofer Utilities (Ver. 2.11 or later) is installed.

## Uninstalling the printer driver

Follow the steps below to remove the printer driver and EPSON LFP Remote Panel 2.

#### Note:

- You must log in with an Administrator account.
- In Windows 7/Windows Vista, if an Administrator password or confirmation is requested, enter the password and then continue with the operation.

**1** Turn off the printer, and unplug the interface cable.

**2** Go to the **Control Panel** and click **Uninstall a program** from the **Programs** category.

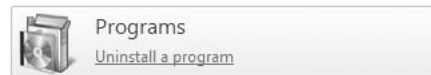

**3** Select the software you want to remove and then click **Uninstall/Change** (or **Change/Remove/add or remove**).

You can remove EPSON Status Monitor 3 and the printer driver by selecting **Epson Stylus Pro 4900/4910 Printer Uninstall**.

Select **EPSON LFP Remote Panel 2** to remove EPSON LFP Remote Panel 2.

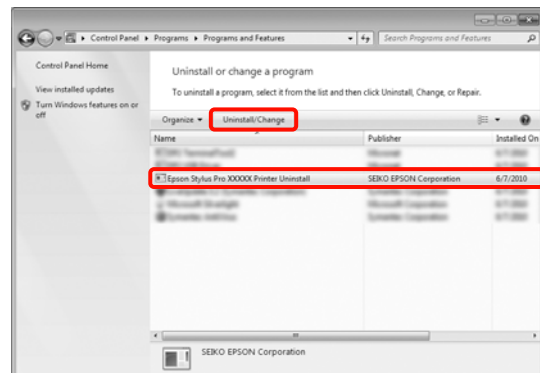



## Using the Printer Driver(Windows)

- 4** Select the target printer icon, and then click **OK**.

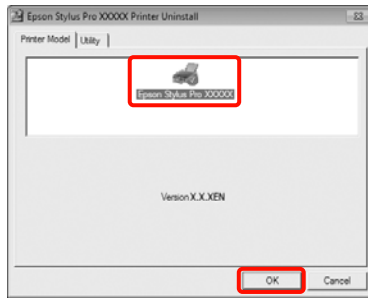

**Tip:**

You can also remove **Epson Network Utility** by clicking the **Utility** tab and selecting the **Epson Network Utility**. However, if you are using other Epson printer(s), their printer driver(s) may also be using the Epson Network Utility. If you are using other Epson printer(s), do not remove Epson Network Utility.

- 5** Follow the on-screen instructions to continue.

When the delete confirmation message appears, click **Yes**.

Restart the computer if you are reinstalling the printer driver.

Using the Printer Driver(Mac OS X)

# Using the Printer Driver (Mac OS X)

## Displaying the Settings Screen

The display method of the printer driver setting screen may differ depending on the application or the OS version.

 [“Basic Printing Methods\(Mac OS X\)” on page 44](#)

## Displaying Help

Click  in the printer driver setting screen to display Help.



# Using Epson Printer Utility 4

You can perform maintenance tasks such as Nozzle Check or Head Cleaning by using Epson Printer Utility 4. This utility is installed automatically when you install the printer driver.

## Starting Epson Printer Utility 4

Double-click the **Applications** folder, the **Epson Software** folder, and then the **Epson Printer Utility 4** icon.

## Epson Printer Utility 4 Functions

You can perform the following maintenance functions from Epson Printer Utility 4.



## Using the Printer Driver(Mac OS X)

### EPSON Status Monitor

You can check the printer's status, such as the remaining ink level and error messages, from the computer's screen.

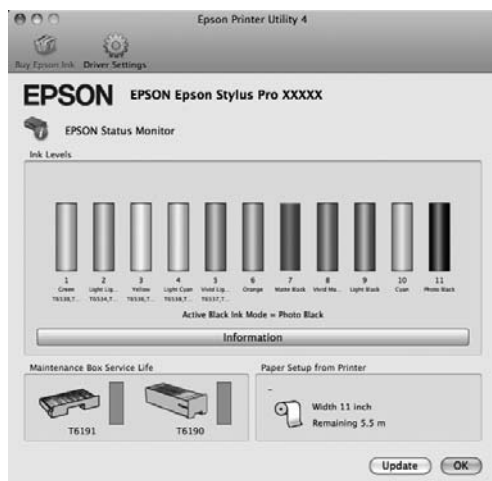

### Nozzle Check

This function prints a nozzle check pattern to check if the print head nozzles are clogged. If you see banding or gaps in the print outs, perform head cleaning to clear any clogged nozzles.

["Cleaning the print head" on page 115](#)

### Head cleaning

If you see banding or gaps in the print outs, perform head cleaning. Cleans the surface of the print head to improve the print quality.

["Cleaning the print head" on page 115](#)

### Print Head Alignment

If the print results appear grainy or out of focus, perform Print Head Alignment. The Print Head Alignment function corrects print head gaps.

["Correcting Print Misalignment \(Print Head Alignment\)" on page 117](#)

### EPSON LFP Remote Panel 2

You can update the printer's firmware and make custom paper settings. See the EPSON LFP Remote Panel 2 help for details.

### Printer Firmware Update

You can update the printer's firmware to the latest version. See the EPSON LFP Remote Panel 2 help for details.

## Uninstalling the printer driver

Follow the steps below to remove the printer driver and EPSON LFP Remote Panel 2.

### Note:

*You must log in with an Administrator account.*

- 1 Turn off the printer, and unplug the interface cable.
- 2 Close all open applications.
- 3 Click the Apple Menu, the **System Preferences** folder, and then the **Print & Fax (Print & Scan for Mac OS X v10.7)** folder.
- 4 Select this printer, and then click -.

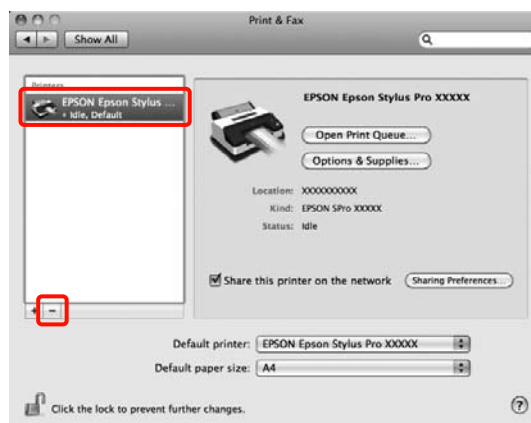

- 5 Click **Delete Printer** (or **OK**).
- 6 Insert the "Software Disc" supplied with this printer into your computer.

## Using the Printer Driver(Mac OS X)

- 7** Double-click the **Printer** folder and then the **Driver** folder.



**Tip:**  
If the folder does not appear, double-click the EPSON icon on the desktop.



- 8** Double-click the icon.

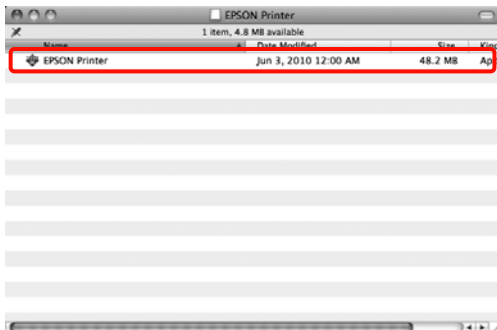

- 9** If the following screen is displayed, enter the password for the user logged in to the Mac OS X, and then click **OK**.



- 10** If the license agreement screen is displayed, confirm the contents, click **Continue**, and then click **Agree**.

- 11** Select **Uninstall**, and then click **Uninstall**.

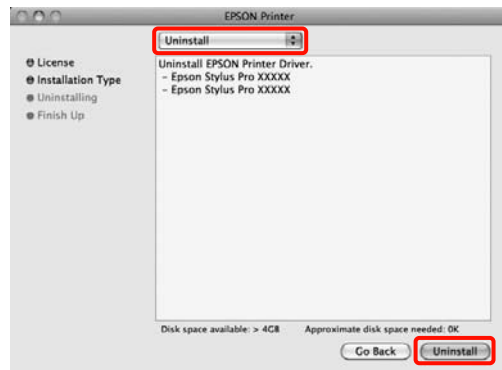

- 12** Follow the on-screen instructions to continue.

## Removing EPSON LFP Remote Panel 2

Delete EPSON LFP Remote Panel 2 by deleting the EPSON LFP Remote Panel 2 folder. See the EPSON LFP Remote Panel 2 help for details.

Printing Varieties

# Printing Varieties

## Auto Correct Color and Print Photos (PhotoEnhance)

The printer driver for this printer comes with the Epson proprietary function PhotoEnhance that makes the most efficient use of the color reproduction area, corrects image data to improve colors before printing.

By using PhotoEnhance, you can correct photo colors to match the subject types such as people, scenery, or night view. You can print color data in sepia or black and white. Colors are automatically corrected simply by selecting the print mode.

**Tip:**  
It is recommended that you use images with a color space of sRGB.

This function is not available for Mac OS X.

**1** When using applications featuring a color management function, specify how to adjust colors from these applications.

When using applications without a color management function, start from step 2.

Depending on the type of the application, make the settings following the table below.

Adobe Photoshop CS3 or later  
 Adobe Photoshop Elements 6.0 or later  
 Adobe Photoshop Lightroom 1 or later

OS	Color Management Settings
Windows 7 Windows Vista	Printer Manages Colors
Windows XP (Service Pack 2 or later and .NET 3.0 or later)	

OS	Color Management Settings
Windows XP (other than the above)	No Color Management

In other applications, set **No Color Management**.

Example of Adobe Photoshop CS4

Open the **Print** screen.

Select **Color Management** and then **Document**. Select **Printer Manages Colors** as the **Color Handling** setting, and then click **Print**.



**2** When the printer driver's **Main** screen is displayed, click **Custom**, **PhotoEnhance**, and then **Advanced**.

➡ “Basic Printing Methods(Windows)” on page 43

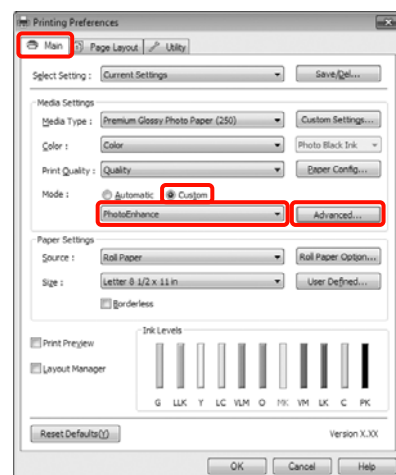

## Printing Varieties

- 3 On the **PhotoEnhance** screen, you can set effects to apply to the print data.

See the printer driver help for more details on each item.

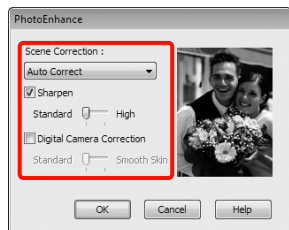

- 4 Check other settings, and then start printing.

## Correct color and print

The printer driver automatically and internally corrects colors to match the color space. You can select from the following color correction modes.

- Charts and Graphs**  
Performs color correction to sharpen your images based on the sRGB space.
- EPSON Standard (sRGB)**  
Optimizes the sRGB space and corrects the color.
- Adobe RGB**  
Optimizes the Adobe RGB space and corrects the color.

Furthermore, if you select Color Controls, you can fine-tune Gamma, Brightness, Contrast, Saturation, and Color Balance for each color correction mode.

Use this option when the application in use does not have a color correction function.

### Making Settings in Windows

- 1 When using applications featuring a color management function, specify how to adjust colors from these applications.

When using applications without a color management function, start from step 2.

Depending on the type of the application, make the settings following the table below.

Adobe Photoshop CS3 or later  
 Adobe Photoshop Elements 6.0 or later  
 Adobe Photoshop Lightroom 1 or later

OS	Color Management Settings
Windows 7 Windows Vista	Printer Manages Colors
Windows XP (Service Pack 2 or later and .NET 3.0 or later)	
Windows XP (other than the above)	No Color Management

## Printing Varieties

In other applications, set **No Color Management**.

Example of Adobe Photoshop CS4

Open the **Print** screen.

Select **Color Management** and then **Document**. Select **Printer Manages Colors** as the **Color Handling** setting, and then click **Print**.

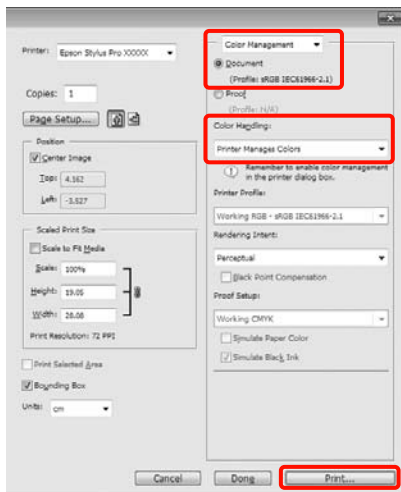

**2** When the printer driver's **Main** screen is displayed, select the color correction mode.

[“Basic Printing Methods\(Windows\)” on page 43](#)

To perform automatic color correction, select **Automatic** and then select the color correction mode.

If you select **Custom** mode to make settings manually, select **Color Controls**, and then click **Advanced**.

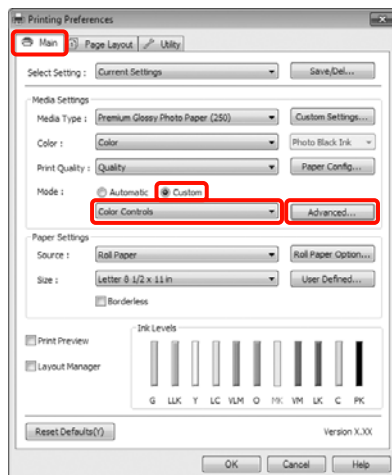

**3** Set each item when you select **Custom**.

See the printer driver help for more details on each item.

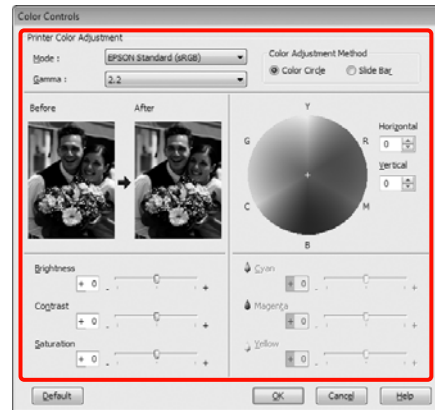

**Tip:**  
You can adjust the correction value by checking the sample image on the left side of the screen. You can also use the color circle to fine-tune the color balance.

**4** Check other settings, and then start printing.

### Making Settings for Mac OS X

**1** When using applications featuring a color management function, specify how to adjust colors from these applications.

When using applications without a color management function, start from step 2.

Depending on the type of the application, make the settings following the table below.

Adobe Photoshop CS3 or later  
Adobe Photoshop Elements 6 or later  
Adobe Photoshop Lightroom 1 or later

OS	Color Management Settings
Mac OS X 10.7, 10.6 and 10.5	Printer Manages Colors
Mac OS X 10.4	No Color Management

In other applications, set **No Color Management**.

## Printing Varieties

Example of Adobe Photoshop CS4

Open the **Print** screen.

Select **Color Management** and then **Document**.  
Select **Printer Manages Colors** as the **Color Handling** setting, and then click **Print**.

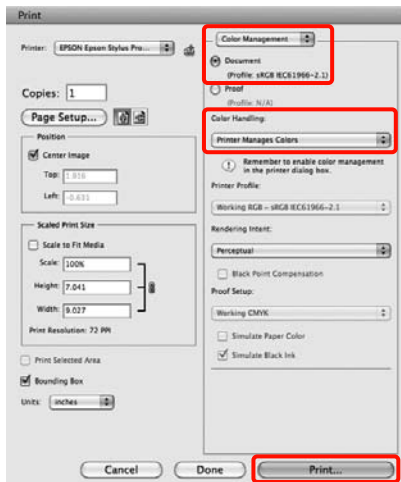

**2** Display the Print screen.

➤ “Basic Printing Methods(Mac OS X)” on page 44

**3** For Mac OS X 10.7, 10.6 and 10.5 select **Color Matching** from the list, and then click **EPSON Color Controls**.

For Mac OS X 10.4, go to step 4.

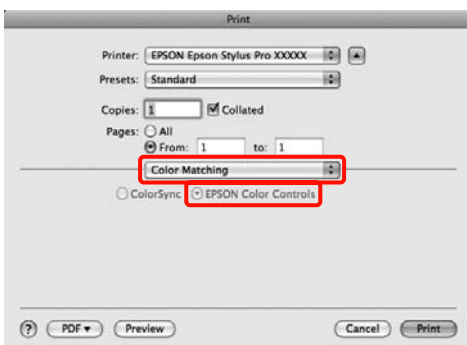

**Tip:**

When using the following applications with Mac OS X 10.7, 10.6, or 10.5 make sure you perform step 1, otherwise you cannot select **EPSON Color Controls**.

- Adobe Photoshop CS3 or later
- Adobe Photoshop Lightroom 1 or later
- Adobe Photoshop Elements 6 or later

**4** Display the **Advanced Color Settings** screen for color correction.

Select **Print Settings** from the list, and select **EPSON Standard (sRGB)** or **Charts and Graphs**, from **Color Controls** in **Color Settings**. When adjusting the parameters manually, click **Advanced Color Settings**.

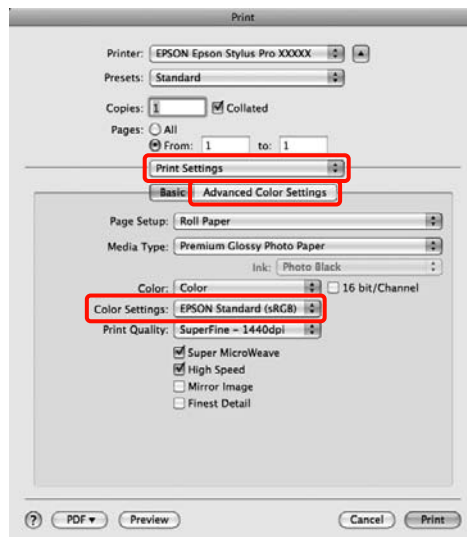

**Tip:**

When using the following applications with Mac OS X 10.5, clear the **Use Generic RGB** checkbox.

- Adobe Photoshop CS3 or later
- Adobe Photoshop Lightroom 1 or later
- Adobe Photoshop Elements 6 or later

Select the check box when using a different application from those listed above.



## Printing Varieties

**5** Make the necessary settings.

See the printer driver help for more details on each item.

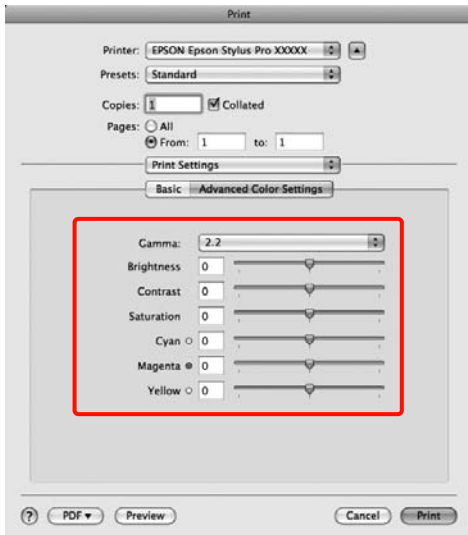

**6** Check other settings, and then start printing.

## Printing Black and White Photos

You can print black and white photos with rich gradation by adjusting the image data color by the printer driver.

The original data is not affected.

You can correct image data when printing without processing the data from applications.

**Tip:**

*It is recommended that you use images with a color space of sRGB.*

### Making Settings in Windows

**1** When using applications featuring a color management function, specify how to adjust colors from these applications.

When using applications without a color management function, start from step 2.

Depending on the type of the application, make the settings following the table below.

- Adobe Photoshop CS3 or later
- Adobe Photoshop Elements 6 or later
- Adobe Photoshop Lightroom 1 or later

OS	Color Management Settings
Windows 7 Windows Vista	Printer Manages Colors
Windows XP (Service Pack 2 or later and .NET 3.0 or later)	
Windows XP (other than the above)	No Color Management

In other applications, set **No Color Management**.

Example of Adobe Photoshop CS4

Open the **Print** screen.

## Printing Varieties

Select **Color Management** and then **Document**. Select **Printer Manages Colors** or **No Color Management** as the **Color Handling** setting, and then click **Print**.



**2** When the printer driver's **Main** screen is displayed, select **Advanced B&W Photo** as the **Color**.

[“Basic Printing Methods\(Windows\)”](#) on page 43

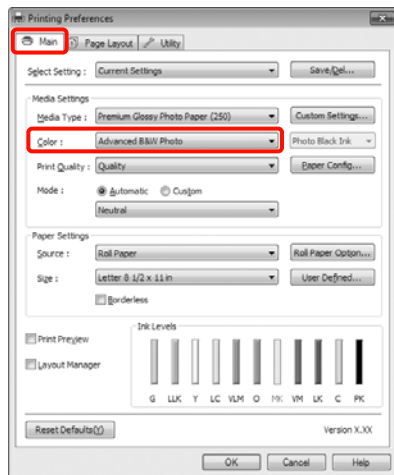

**3** Select **Custom** as the **Mode** setting, and then click **Advanced**.

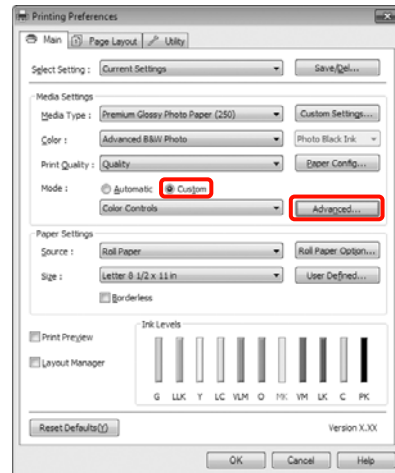

**4** Make the necessary settings.

See the printer driver help for more details on each item.

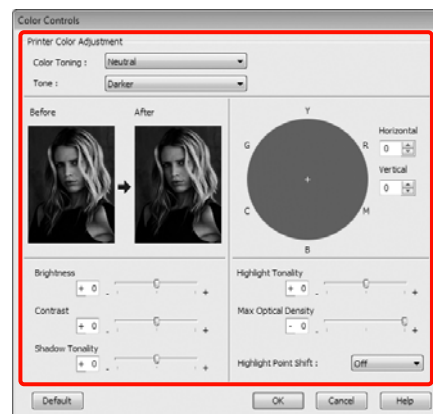

**5** Check other settings, and then start printing.

### Making Settings for Mac OS X

**1** When using applications featuring a color management function, specify how to adjust colors from these applications.

Depending on the type of the application, make the settings following the table below.

Adobe Photoshop CS3 or later  
 Adobe Photoshop Elements 6 or later  
 Adobe Photoshop Lightroom 1 or later

## Printing Varieties

OS	Color Management Settings
Mac OS X 10.7, 10.6 and 10.5	Printer Manages Colors
Mac OS X 10.4	No Color Management

In other applications, set **No Color Management**.

Example of Adobe Photoshop CS4

Open the **Print** screen.

Select **Color Management** and then **Document**. Select **Printer Manages Colors** as the **Color Handling** setting, and then click **Print**.

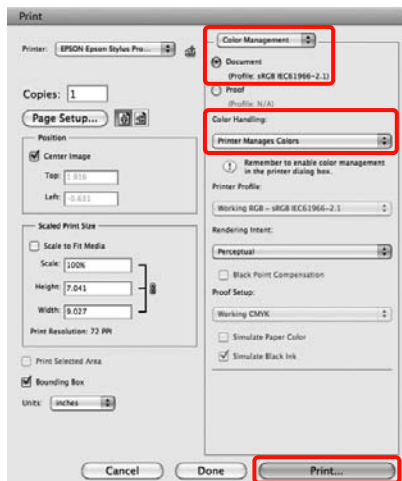

2

Display the **Print** screen, select **Print Settings** from the list, and then select **Advanced B&W Photo** as the **Color**.

☞ “Basic Printing Methods(Mac OS X)” on page 44

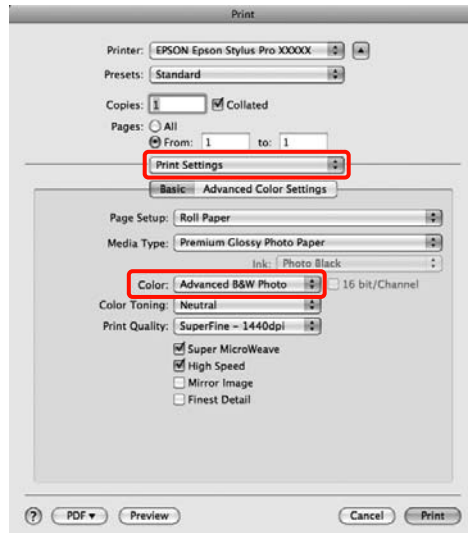

**Tip:**  
 When using the following applications with Mac OS X 10.5, clear the **Use Generic RGB** checkbox.

- Adobe Photoshop CS3 or later
- Adobe Photoshop Lightroom 1 or later
- Adobe Photoshop Elements 6 or later

Select the check box when using a different application from those listed above.

3

Click **Advanced Color Settings**.

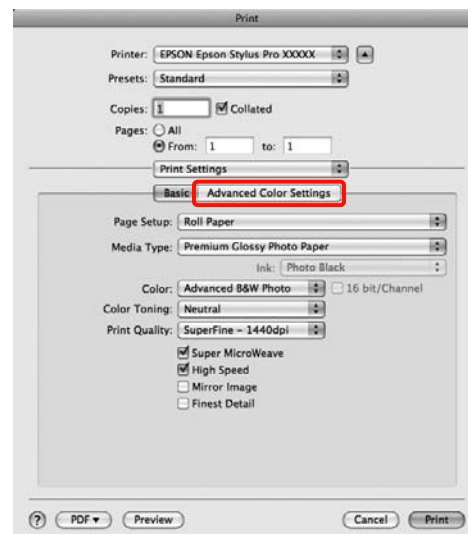

## Printing Varieties

### 4 Make the necessary settings.

See the printer driver help for more details on each item.

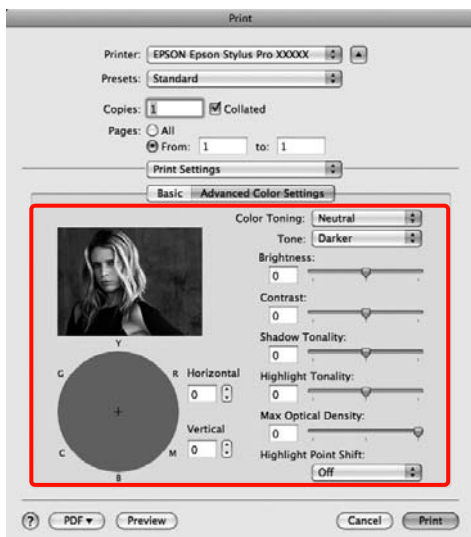

### 5 Check other settings, and then start printing.

## Borderless printing

You can print your data without margins on the paper.

The types of borderless printing you can choose vary as shown below depending on the media type.

Roll Paper: No margins for all edges\*, no margins for the left and right

Cut Sheets: No margins for the left and right only

\* When the optional SpectroProofer is installed borderless printing for all edges cannot be performed.

When printing borderless for all edges you can also configure the cutting operation. [“About Roll Paper Cutting” on page 70](#)

When performing left and right borderless printing, margins appear on the top and bottom of the paper.

Top and bottom margin values [“Printable area” on page 46](#)

## Types of Borderless Printing Methods

You can perform borderless printing using the following two methods.

### Auto Expand

The printer driver enlarges the print data to a size slightly larger than the paper size and prints the enlarged image. The sections which are beyond the paper edges are not printed; therefore, resulting in borderless printing.

Use settings such as Page Layout in the applications to set the size of the image data as follows.

- Match the paper size and page setting for the print data.
- If the application has margin settings, set the margins to 0 mm.
- Make the image data as large as the paper size.

## Printing Varieties

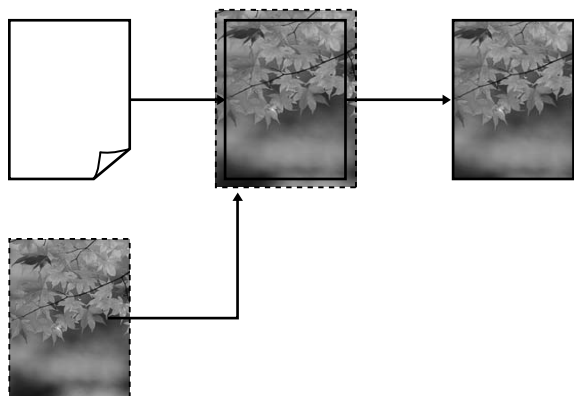

### Retain Size

Create the print data larger than the paper size in the applications to produce borderless output. The printer driver does not enlarge the image data. Use settings such as Page Layout in the applications to set the size of the image data as follows.

- Create print data larger than its actual print size by 3 mm on the left and right (6 mm in total).
- If the application has margin settings, set the margins to 0 mm.
- Make the image data as large as the paper size.

Select this setting if you want to avoid image enlargement by the printer driver.

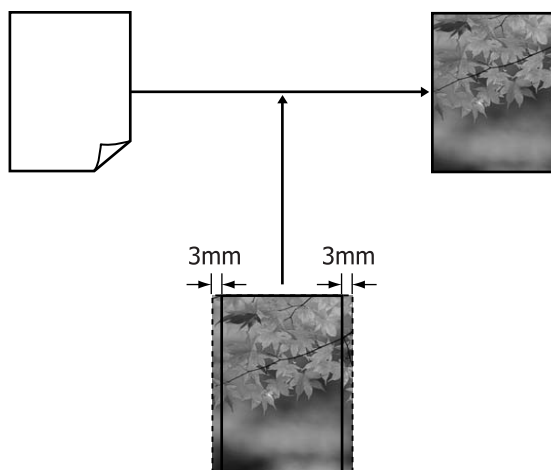

## Supported Media Sizes for Borderless Printing

The following media sizes are supported for borderless printing.

The supported paper sizes vary depending on if you are using roll paper or cut sheets.

Supported paper widths	Roll paper	Cut sheet
A4/210 mm	✓	✓
A3/297 mm	✓	✓
Super A3/B/329 mm	✓	✓
SuperW A3/329 mm	✓	✓
A2/420 mm*	✓	-
US B/11 inch*	✓	-
US C/17 inch	✓	✓
8 inch*	✓	-
10 inch	✓	✓
16 inch	✓	✓
30 cm	✓	✓

\* You can perform borderless printing only when using the borderless printing spacer supplied with the printer and printing on roll paper with a 2 inch paper core. [“Removing and installing the spacer” on page 28](#)

Depending on the media type, the print quality may decline or borderless printing cannot be selected.

[“Epson Special Media Table” on page 153](#)

## Printing Varieties

### About Roll Paper Cutting

When performing borderless printing on roll paper, you can specify whether it is left and right borderless printing or all edges borderless printing, and how to cut the paper in the printer driver's **Roll Paper Option**. The cutting operation for each value is shown in the following chart.

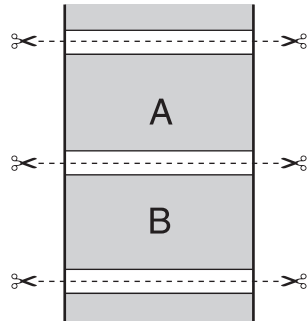
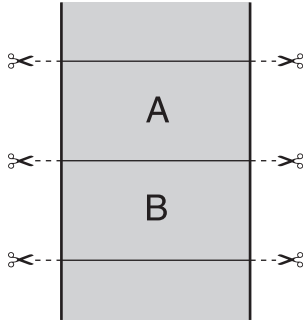
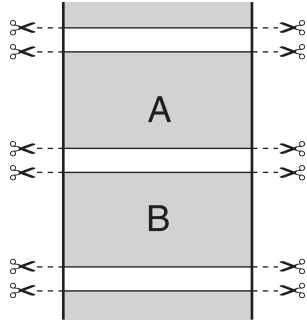
Printer driver settings	Normal Cut	Single Cut	Double Cut
Cutting Operation			
Explanation	<p>The default printer driver setting is <b>Normal Cut</b>.</p>	<ul style="list-style-type: none"> <li><input type="checkbox"/> The top area may become slightly uneven depending on the image since the print operation stops while cutting the top edge of the roll paper.</li> <li><input type="checkbox"/> If the cut position is misaligned slightly, small parts of the image may be shown on the top or bottom of the adjacent pages. If this occurs, perform <b>Cutter Adjustment</b>. <a href="#">👉 "Maintenance menu" on page 105</a></li> <li><input type="checkbox"/> When printing only one page the operation performed is the same as that for <b>Double Cut</b>. When continuously printing multiple sheets, the printer cuts 1 mm inside on the top edge of the first page and the bottom edge of the subsequent pages to avoid showing margins.</li> </ul>	<ul style="list-style-type: none"> <li><input type="checkbox"/> The top area may become slightly uneven depending on the image since the print operation stops while cutting the top edge of the roll paper.</li> <li><input type="checkbox"/> The printed paper is approximately 2 mm shorter than the specified size since the printer cuts the paper inside the image to avoid showing top and bottom margins.</li> <li><input type="checkbox"/> After cutting the bottom edge of the previous page, the printer feeds the paper, and then cuts the top edge of the following page. Although this produces 80 to 127 mm cut-off pieces, the cut is more accurate.</li> </ul>

Printing Varieties

# Setting Procedures for Printing

## Making Settings in Windows

**1** When the printer driver's **Main** screen is displayed, you can configure various settings required for printing such as **Media Type**, **Source**, **Page Size**.

[“Basic Printing Methods\(Windows\)” on page 43](#)

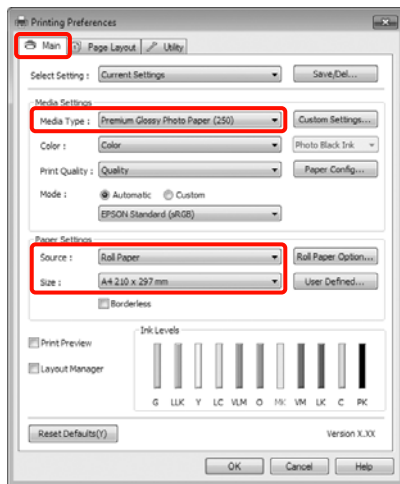

**2** Select **Borderless**, and then click **Expansion**.

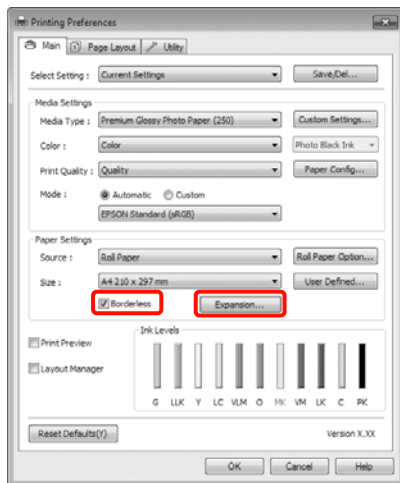

**3** Select **Auto Expand** or **Retain Size** as the **Method of Enlargement**. If you select **Auto Expand**, set how much of the image goes beyond the edge of the paper as shown below.

Max : 3 mm for left and 5 mm for right  
(the image shifts 1 mm to the right)

Standard : 3 mm for left and right

Min : 1.5 mm for left and right

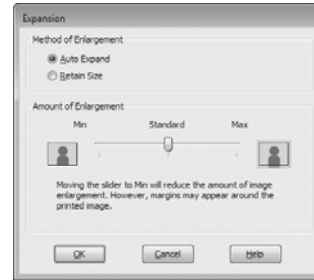

**Tip:**  
Moving the slider towards **Min** decreases the image enlargement ratio. Therefore, some margins may appear at the edges of the paper depending on the paper and printing environment.

**4** When printing on roll paper, click **Roll Paper Option**, and select the **Auto Cut** setting.

[“About Roll Paper Cutting” on page 70](#)

**5** Check other settings, and then start printing.

## Making Settings for Mac OS X

**1** Open the Print screen and select the paper size from the **Paper Size** option, and then select a borderless printing method.

[“Basic Printing Methods\(Mac OS X\)” on page 44](#)

The selections for borderless printing methods are displayed as shown below.

XXXX (Roll Paper - Borderless (Auto Expand))

XXXX (Roll Paper - Borderless (Retain Size))

XXXX (Sheet - Borderless (Auto Expand))

XXXX (Sheet - Borderless (Retain Size))

Where XXXX is the actual paper size, such as A4.

## Printing Varieties

When using Mac OS X 10.4, or if items on the Page Setup screen are not displayed on the Print screen due to the application being used in Mac OS X 10.7, 10.6, or 10.5, display the Page Setup screen and make settings.

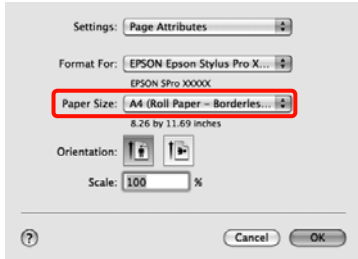

**2** If **Auto Expand** is selected, set how much of the image goes beyond the edge of the paper in the **Expansion** screen.

Select **Page Layout Settings** from the list. The following shows how much the image will be larger than the paper edges.

- Max : 3 mm for left and 5 mm for right (the image shifts 1 mm to the right)
- Standard : 3 mm for left and right
- Min : 1.5 mm for left and right

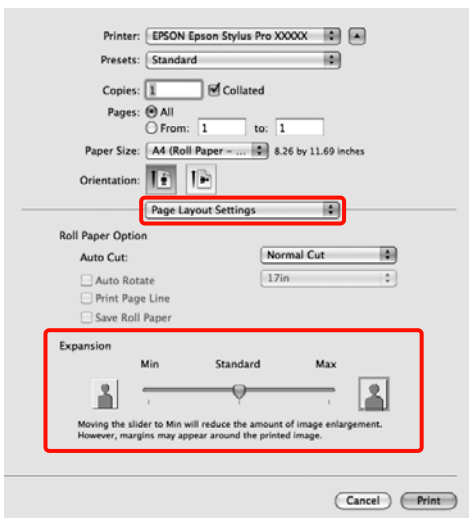

**Tip:**

Moving the slider towards **Min** decreases the image enlargement ratio. Therefore, some margins may appear at the edges of the paper depending on the paper and printing environment.

**3** When printing on roll paper, select **Auto Cut**.

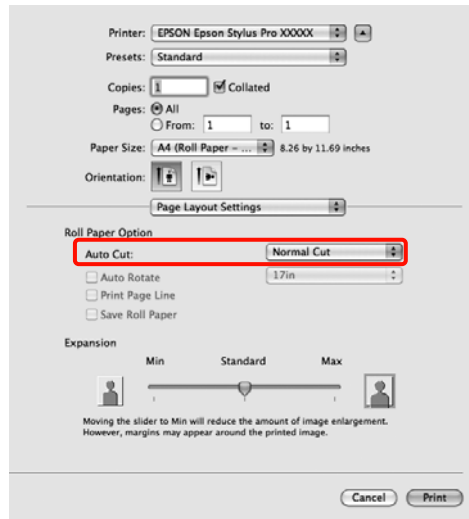

[“About Roll Paper Cutting” on page 70](#)

**4** Select **Print Settings** from the list, and then set the **Media Type**.

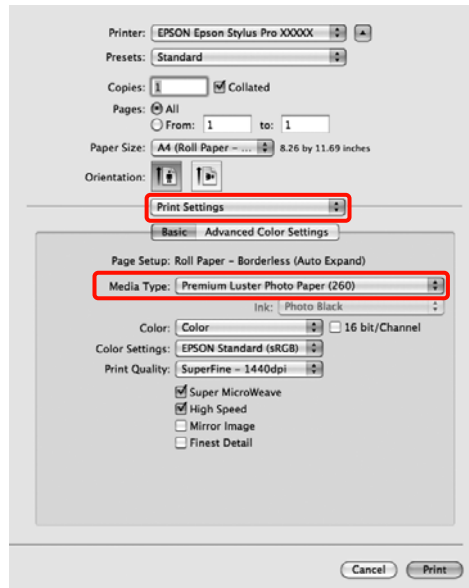

**5** Check other settings, and then start printing.



Printing Varieties

# Enlarged/Reduced Printing

You can enlarge or reduce the size of your data. There are three setting methods.

Fit to Page printing

Automatically enlarges or reduces the image size to fit the paper size.

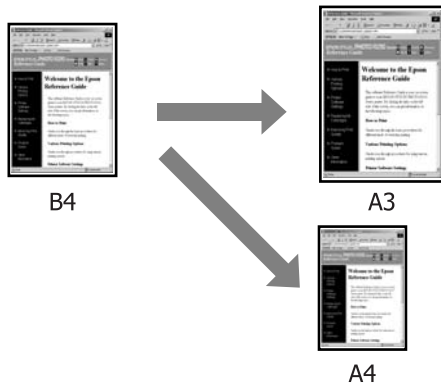

Fit to Roll Paper Width (Windows only)

Automatically enlarges or reduces the image size to fit the roll paper width.

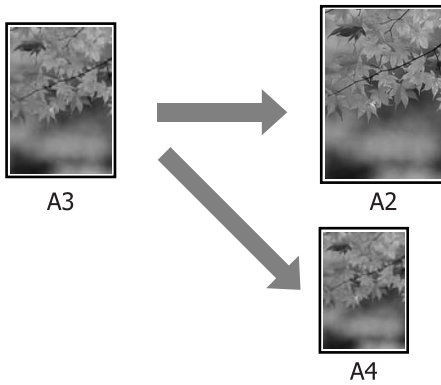

Custom

You can specify the enlargement or reduction ratio. Use this method for a non-standard paper size.

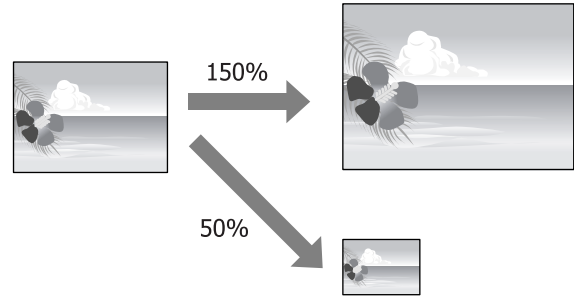

## Fit to Page/Scale to fit paper size

### Making Settings in Windows

**1** When the printer driver's **Page Layout** screen is displayed, set the same paper size as the data's paper size in **Page Size** or **Paper Size**.

[“Basic Printing Methods\(Windows\)” on page 43](#)

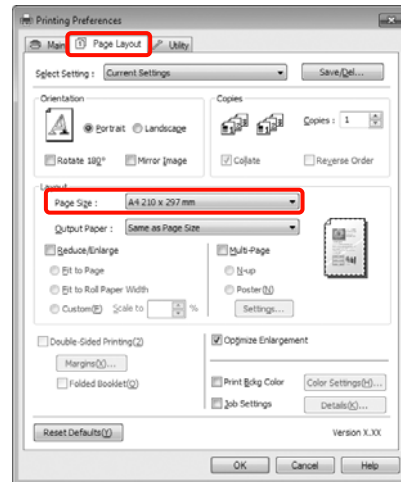

## Printing Varieties

- 2 Select the size of the paper loaded in the printer from the **Output Paper** list.

**Fit to Page** is selected as **Reduce/Enlarge**.

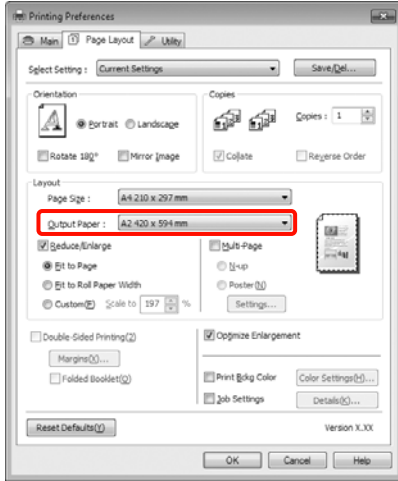

- 3 Check other settings, and then start printing.

### Making Settings for Mac OS X

- 1 Open the Print screen, select **Paper Handling** from the list, and then check **Scale to fit paper size**.

[“Basic Printing Methods\(Mac OS X\)”](#) on page 44

For Mac OS X 10.7, 10.6, or 10.5

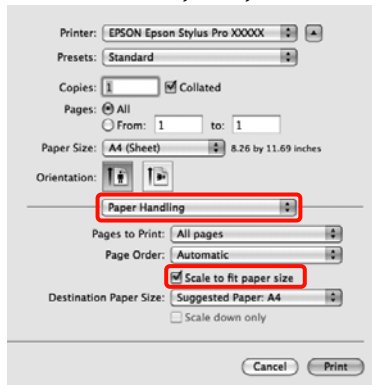

### For Mac OS X 10.4

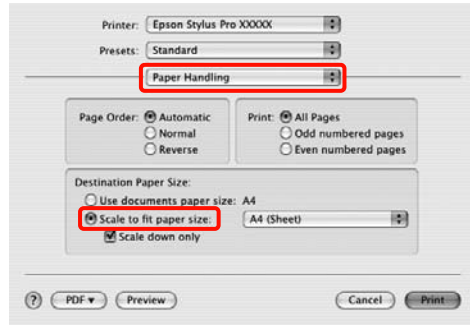

- 2 Select the size of the paper loaded in the printer as the **Destination Paper Size**.

**Tip:**  
When performing enlarged printing, clear the **Scale down only** check box.

- 3 Check other settings, and then start printing.

## Fit to Roll Paper Width (Windows only)

- 1 When the printer driver's **Page Layout** screen is displayed, set the same paper size as the data's paper size in **Page Size** or **Paper Size**.

[“Basic Printing Methods\(Windows\)”](#) on page 43

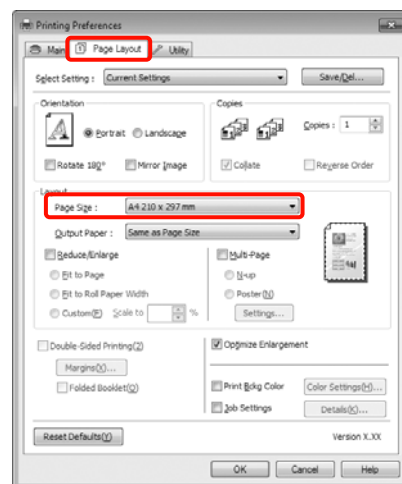

## Printing Varieties

- 2 Select **Reduce/Enlarge**, and then click **Fit to Roll Paper Width**.

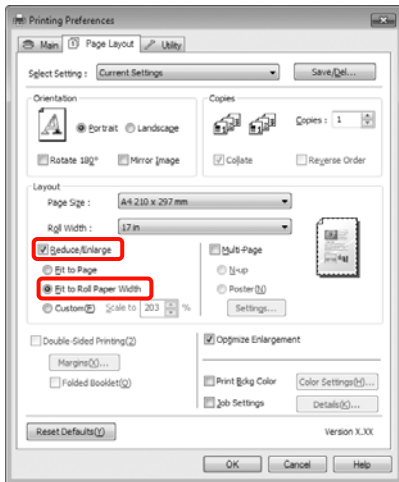

- 3 Select the width of the roll paper loaded in the printer from the **Roll Width** list.

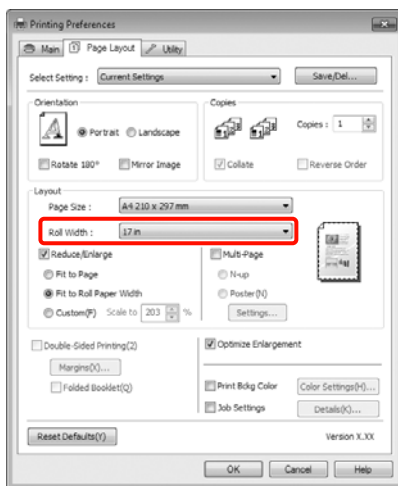

- 4 Check other settings, and then start printing.

## Custom Scale Setting

### Making Settings in Windows

- 1 When the printer driver's **Page Layout** screen is displayed, set the same paper size as the data's paper size in **Page Size** or **Paper Size**.

[“Basic Printing Methods\(Windows\)” on page 43](#)

- 2 Select the size of the paper loaded in the printer from the **Output Paper** or **Roll Width** list.

- 3 Select **Reduce/Enlarge**, click **Custom**, and then set the **Scale to** value.

Enter a value directly or click the arrows to the right of the scale box to set the value.

Select the scale within a range of 10 to 650 %.

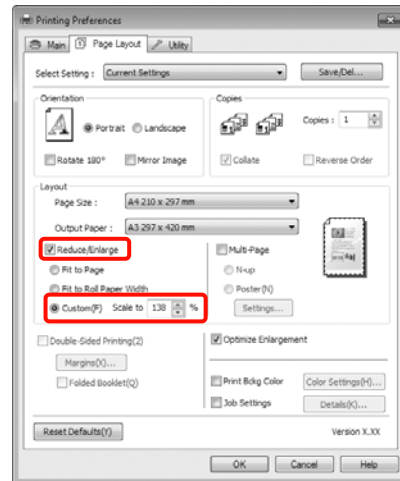

- 4 Check other settings, and then start printing.

### Making Settings for Mac OS X

- 1 When the Print screen is displayed, select the size of the paper loaded in the printer from the **Paper Size** list.

When using Mac OS X 10.4, or if items on the Page Setup screen are not displayed on the Print screen due to the application being used in Mac OS X 10.7, 10.6, or 10.5, display the Page Setup screen and make settings.

[“Basic Printing Methods\(Mac OS X\)” on page 44](#)

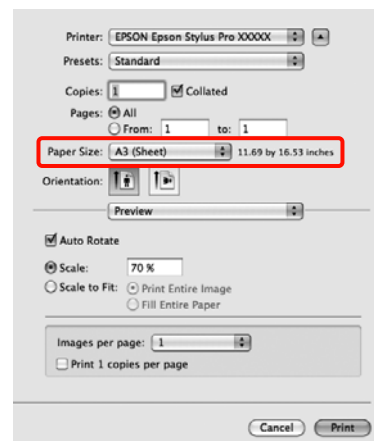

Printing Varieties

**2** Set the scale in **Scale**.

If **Scale** is not displayed on the Print screen, open the Page Setup screen, and then make the settings.

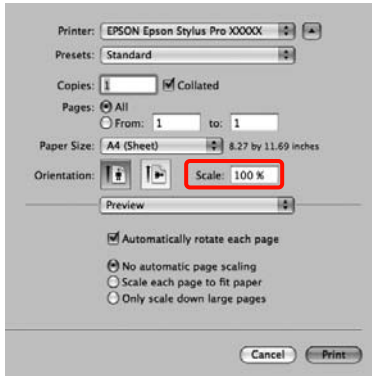

You can now print as normal.

## Multi-Page Printing

You can print multiple pages of your document on one sheet of paper.

If you print continuous data prepared at A4 size, it is printed as shown below.

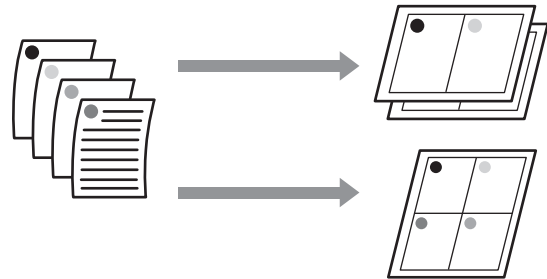

**Tip:**

- ❑ In Windows, you cannot use the Multi-Page printing function when performing borderless printing.
- ❑ In Windows, you can use the reduce/enlarge function (Fit to Page) to print the data on different sizes of paper.

*☞ "Enlarged/Reduced Printing" on page 73*

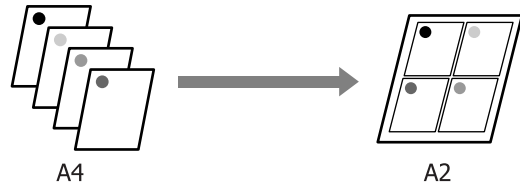

## Printing Varieties

### Making Settings in Windows

- 1 When the printer driver's **Page Layout** screen is displayed, select the **Multi-Page** check box, select **N-up**, and then click **Settings**.

 “Basic Printing Methods(Windows)” on page 43

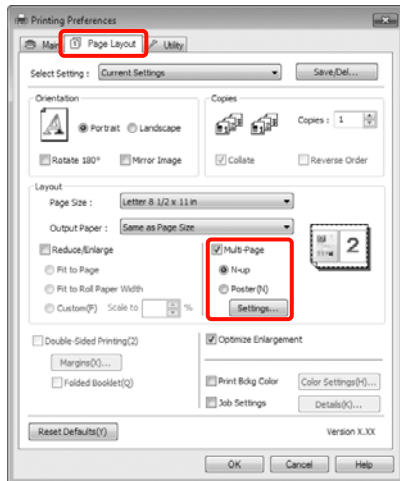

- 2 In the **Print Layout** screen, specify the number of pages per sheet and the page order.

If the **Print page frames** check box is selected, page frames are printed on each page.

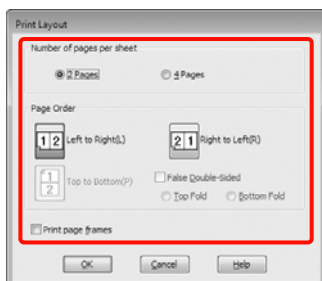

- 3 Check other settings, and then start printing.

### Making Settings for Mac OS X

- 1 When the Print screen is displayed, select **Layout** from the list, and then specify the number of pages per sheet and so on.

 “Basic Printing Methods(Mac OS X)” on page 44

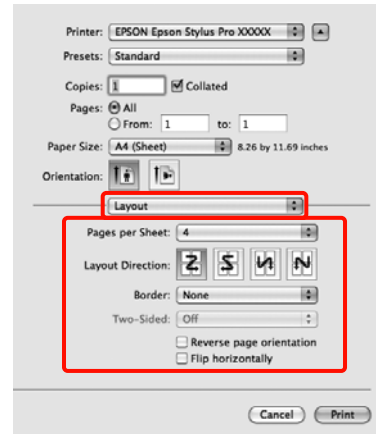

**Tip:**  
You can print frames around arranged pages using the **Border** function.

- 2 Check other settings, and then start printing.

## Printing Varieties

# Manual Double-Sided Printing (Windows only)

You can easily print on both sides of the paper by printing out all even numbered pages and then flipping those pages over and reloading them manually to print the odd numbered pages.

## Cautions when Performing Double-Sided Printing

When performing double-sided printing, note the following points.

- ❑ Depending on the paper type and the print data, ink may seep through to the back side of the paper.
- ❑ The double-sided printing function cannot be used when printing with roll paper.
- ❑ Performing successive double-sided print jobs from a paper cassette can cause a reduction in print quality or paper jams.

If you notice a reduction in print quality, either lower the color density in the printer driver, or feed the paper manually one sheet at a time.

- ❑ Performing successive double-sided print jobs can soil the inside of the printer with ink. If the printed paper is soiled by ink on the roller, clean the printer.

[“Cleaning the paper cassette printing path” on page 127](#)

### Tip:

You can save even more paper by combining this printing method with printing multiple pages on a single page.

[“Multi-Page Printing” on page 76](#)

## Setting Procedures for Printing

- 1 Load cut sheets.

[“Loading Cut Sheets” on page 34](#)

- 2 When the printer driver's **Page Layout** screen is displayed, select **Double-Sided Printing**.

When **Roll Paper** is selected as the **Source** setting, you cannot select **Double-Sided Printing**. In this case, set the **Source** first from the **Main** screen.

[“Basic Printing Methods\(Windows\)” on page 43](#)

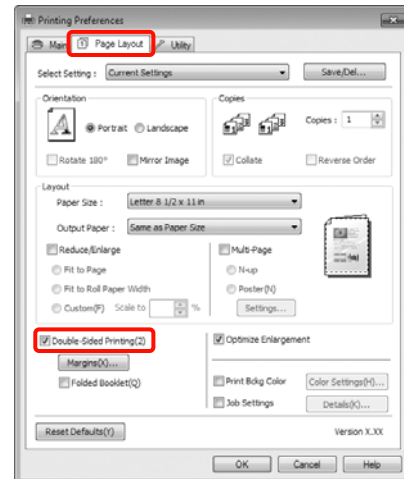

### Tip:

- ❑ You can set the **Binding Edge** and **Binding Margin** by clicking on **Margins**. Depending on the application, the specified binding margin and the actual print result may differ.

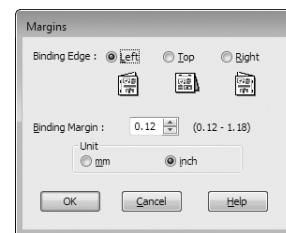

- ❑ Select **Folded Booklet** to print out as a booklet. In the example figure shown below, the pages that appear on the inside when the page is folded in two (pages 2, 3, 6, 7, 10, 11) are printed first.

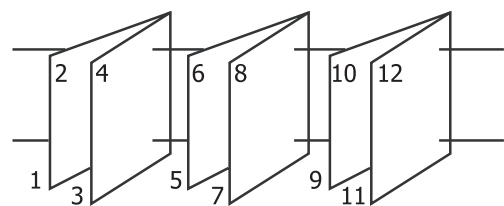

- 3 Check other settings, and then start printing.

## Printing Varieties

- 4** When the odd pages have finished printing and the on-screen guide appears, reload the paper as instructed, and then click **Resume**.

### Poster Printing (Enlarge to cover several sheets and print - Windows only)

The poster printing function automatically enlarges and divides the print data. You can join the printed sheets to create a large poster or calendar. Poster printing is available up to 16-fold (four sheets by four sheets) of normal printing size. There are two ways to print posters.

- Borderless poster printing (Roll paper only)

This automatically enlarges and divides the print data and prints without margins. You can make a poster just by joining the output paper together. To perform borderless printing, the data is expanded so that it extends slightly over the paper size. Enlarged areas that exceed the paper are not printed. Therefore, the image may misalign at the joins. To join the pages precisely, perform the following poster printing with margins.

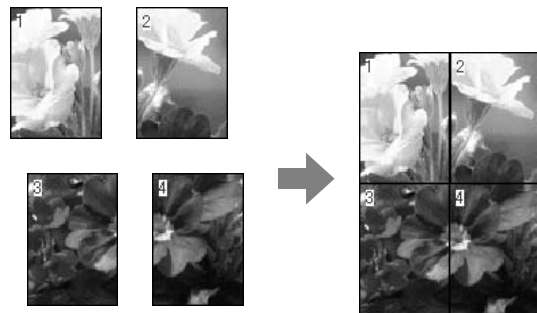

- Poster printing with margins

This automatically enlarges and divides the print data and prints with margins. You need to cut the margins and then join the output paper together to make a poster. Although the final size is slightly smaller since you have to cut off the margins, the image joins fit precisely.

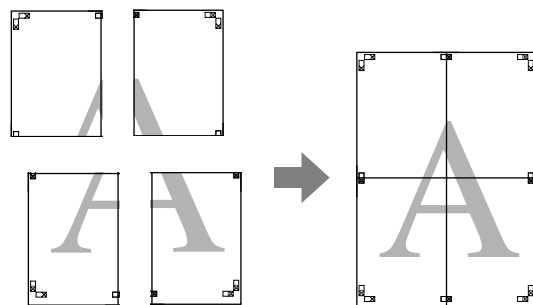

Printing Varieties

Setting Procedures for Printing

1 Prepare the print data using applications.

The printer driver automatically enlarges the image data when printing.

2 When the printer driver's **Page Layout** screen is displayed, select the **Multi-Page** check box, select **Poster**, and then click **Settings**.

☞ “Basic Printing Methods(Windows)” on page 43

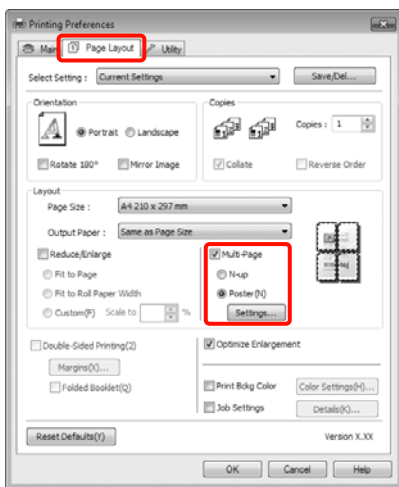

3 In the **Poster Settings** screen, select the number of pages you want in the poster.

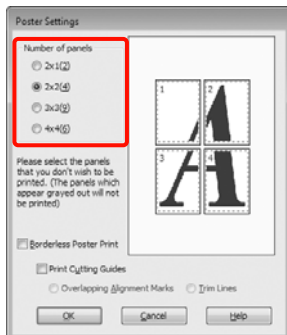

4 Select borderless poster printing or poster printing with margins, and then select any pages that you do not want to print.

**When borderless is selected:**  
Select **Borderless Poster Print**.

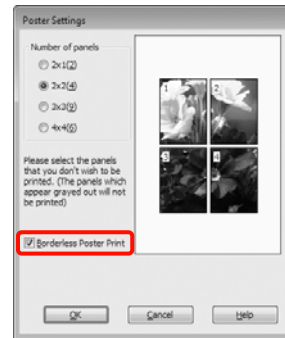

Tip:

❑ If **Borderless Poster Print** is grayed out, the selected paper or the size does not support borderless printing.

☞ “Supported Media Sizes for Borderless Printing” on page 69

☞ “Epson Special Media Table” on page 153

❑ If **Single Cut** or **Double Cut** is selected as the **Auto Cut** setting, the length of the paper is shortened by 1 or 2 mm and the joins do not fit together perfectly.

Select **Off** or **Normal Cut**. ☞ “Borderless printing” on page 68

**When with margins is selected:**  
Clear **Borderless Poster Print**.

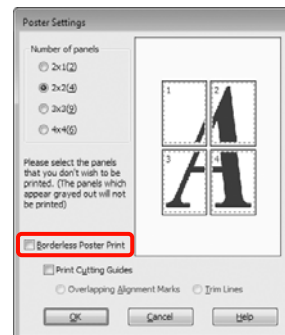



## Printing Varieties

**Tip:**

Regarding the size after joining together:

When **Borderless Poster Print** is cleared and printing with margins is selected, the **Print Cutting Guides** items are displayed.

The finished size is the same whether or not **Trim Lines** is selected. However, if **Overlapping Alignment Marks** is selected, the finished size is smaller with an overlap.

**5** Check other settings, and then start printing.

### Joining the output paper together

The steps for joining the output paper together differ between borderless poster printing and poster printing with margins.

#### Borderless poster printing

This section describes how to join four printed pages together. Check and match the printed pages, and join them in the order indicated below using an adhesive tape on the back of the sheets.

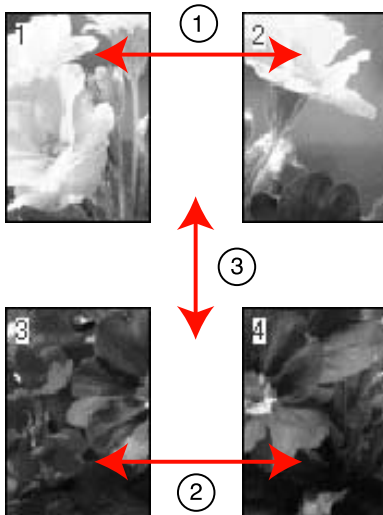

#### Poster printing with margins

When you select **Overlapping Alignment Marks**, the following marks are printed on the paper. See the procedures below to join the four printed pages together using the alignment marks.

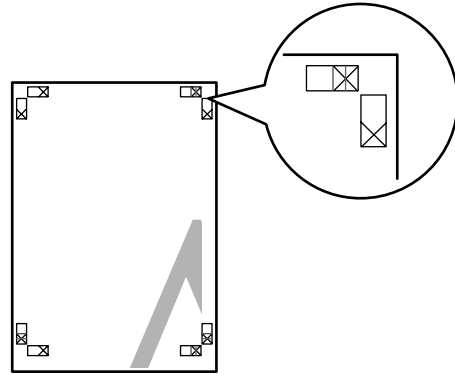

**Tip:**

The alignment marks are black for black-and-white printing.

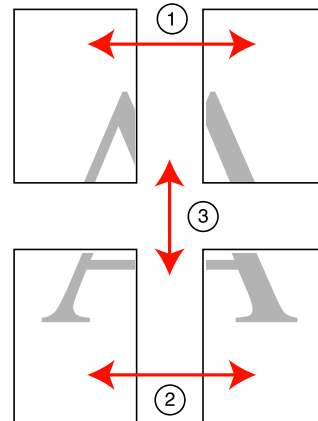

The following describes how to join four printed pages together.

**1** Cut the upper left sheet along the alignment mark (vertical blue line).

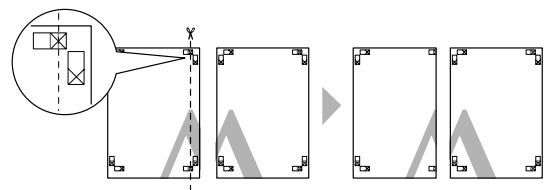

### Printing Varieties

- 2** Lay the upper left sheet on top of upper right sheet. Lineup the X marks as shown in the illustration below, and temporarily fasten them using an adhesive tape on the back.

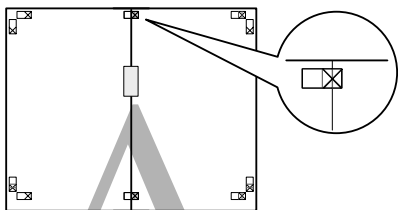

- 3** While two pages are overlapping, cut them along the alignment mark (vertical red line).

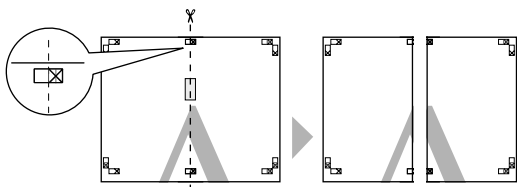

- 4** Join the left and right sheets together.  
Use an adhesive tape to stick the backs of the sheets together.

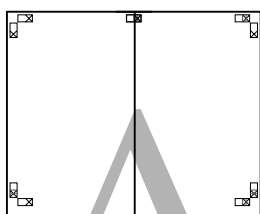

- 5** Repeat steps 1 to 4 for the lower sheets.

- 6** Cut the bottom of the upper sheets along the alignment marks (horizontal blue line).

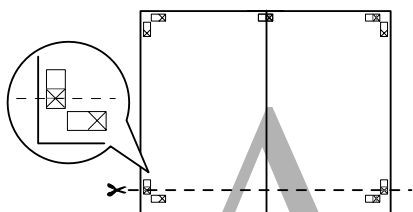

- 7** Lay the upper sheet on top of the lower sheet. Lineup the X marks as shown in the illustration below, and temporarily fasten them using an adhesive tape on the back.

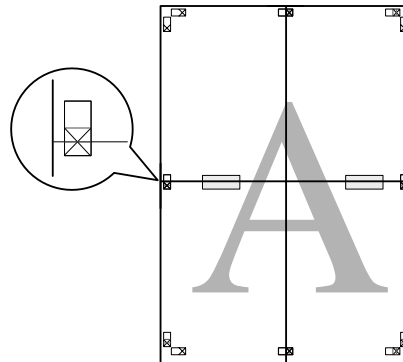

- 8** While two pages are overlapping, cut them along the alignment marks (horizontal red line).

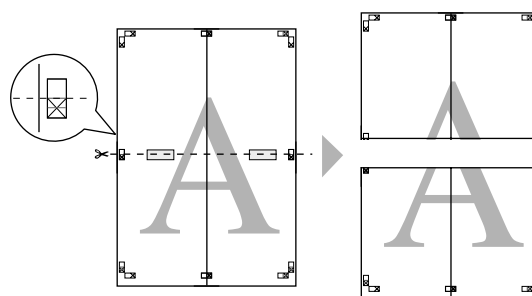

- 9** Join the upper and lower sheets together.  
Use an adhesive tape to stick the backs of the sheets together.

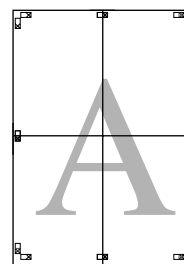

## Printing Varieties

- 10** After joining all of the sheets together, cut the margins along the outer guide lines.

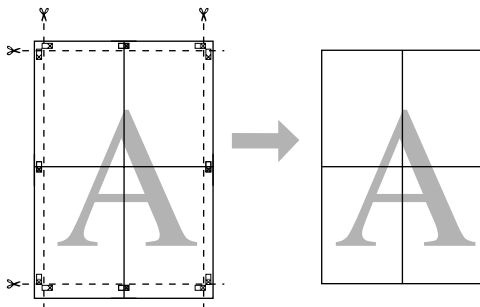

## Printing on custom paper

You can also print on paper sizes that are not already available in the printer driver. If you create and save a user-defined paper size using the steps below, you can select the saved paper size from **Page Setup** in the application. If your application supports creating user defined sizes, follow the steps below to select the same size that was created in the application, and then print.



You can register the following sizes.

The minimum paper size supported by this printer is 203 (width) x 254 (length) mm. If you create a user-defined paper size smaller than this minimum size, you can print on paper that is larger than 203 (width) x 254 (length) mm, and then trim the margins to the size you require.

Width	89 to 432 mm
Length*	Windows: 127 to 15000 mm Mac OS X: 127 to 15240 mm

\* The paper length can be longer if using applications that support banner printing. However, the actual print size depends on the application, the paper size loaded in the printer, and the computer environment.

**Note:**

- For Mac OS X Custom Paper Sizes, although you can specify a large paper size which cannot be loaded on this printer, it will not be printed properly.
- The available output size is limited depending on the application.

## Printing Varieties

### Making Settings in Windows

**1** When the printer driver's **Main** screen is displayed, click **User Defined**.

[“Basic Printing Methods\(Windows\)” on page 43](#)

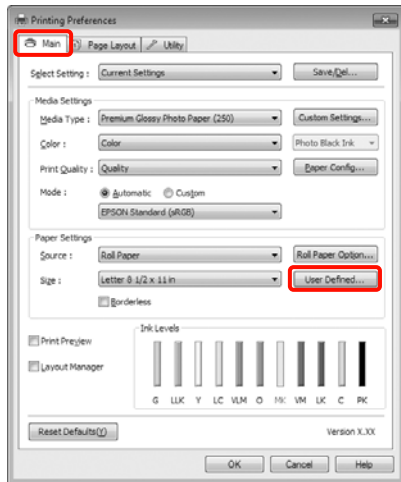

**Note:**  
You cannot select **User Defined** if **Paper Cassette** or **Manual Feed** is selected as the **Source** and **Borderless** is selected as **Paper Settings**.

**2** In the **User Defined Paper Size** screen, set the paper size you want to use, and then click **Save**.

- You can enter up to 24 single-byte characters for the **Paper Size Name**.
- You can easily change the size by selecting a defined paper size close to the size you want to set from **Base Paper Size**.
- If the length and width ratio is the same as a defined paper size, select the defined paper size from **Fix Aspect Ratio** and select either **Landscape** or **Portrait** for the **Base**. In this case, you can only adjust either the paper width or paper height.

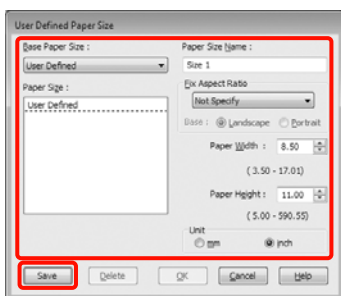

**Tip:**

- To change the paper size you saved, select the paper size name from the list on the left.
- To delete the user-defined size you saved, select the paper size name from the list on the left, and then click **Delete**.
- You can save up to 100 paper sizes.

**3** Click **OK**.

You can select the paper size you saved from **Size** on the **Paper Settings** screen.

You can now print as normal.

### Making Settings for Mac OS X

**1** When the Print screen is displayed, select **Manage Custom Sizes** from the **Paper Size** list.

When using Mac OS X 10.4, or if items on the Page Setup screen are not displayed on the Print screen due to the application being used in Mac OS X 10.7, 10.6, or 10.5, display the Page Setup screen and make settings.

[“Basic Printing Methods\(Mac OS X\)” on page 44](#)

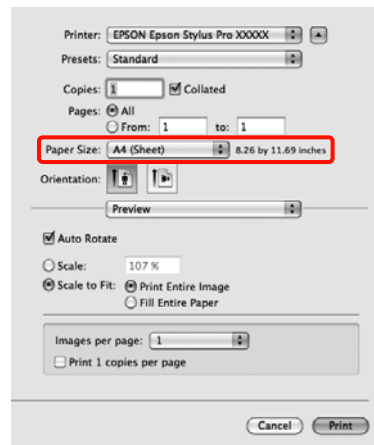

**2** Click **+**, and then enter the paper size name.

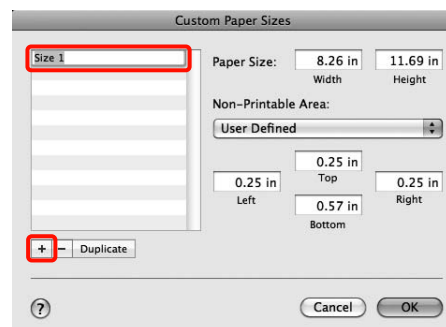

### Printing Varieties

**3** Enter the **Width, Height** for the **Paper Size**, and enter the margins, and then click **OK**.

You can set the page size and printer margins depending on the printing method.

Page Settings	Page Size	Printer Margins
Sheet	Supported media sizes	3 mm for top, left, and right 14.2 mm for bottom
Roll Paper	Supported media sizes	3 mm for top, bottom, left, and right
Roll Paper - Banner	Supported media sizes	0 mm for top and bottom 3 mm for left and right
Roll Paper - Borderless (Auto Expand)	Supported borderless printing paper widths	0 mm for top, bottom, left, and right
Roll Paper - Borderless (Retain Size) Roll Paper - Borderless Banner	Supported borderless printing paper widths + 6 mm	0 mm for top, bottom, left, and right

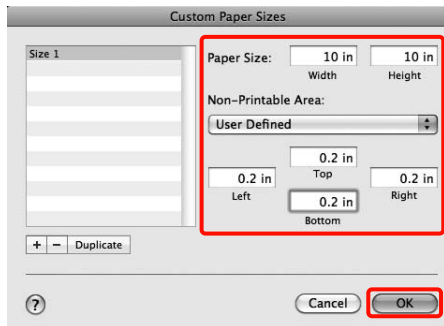

**Tip:**

- To change the contents that you saved, select the paper size name from the list on the left of the **Custom Paper Sizes** screen.
- To duplicate the user-defined size you saved, select the paper size name from the list on the left of the **Custom Paper Sizes** screen, and then click **Duplicate**.
- To delete the user-defined size you saved, select the paper size name from the list on the left of the **Custom Paper Sizes** screen, and then click **-**.
- The custom paper size setting differs depending on the operating system version. See your operating system's documentation for details.

**4** Click **OK**.

You can select the paper size you saved from the Paper Size pop-up menu.

You can now print as normal.

## Printing Varieties

# Banner printing (on roll paper)

You can print banners and panoramic pictures if you create and set print data for banner printing in your application.

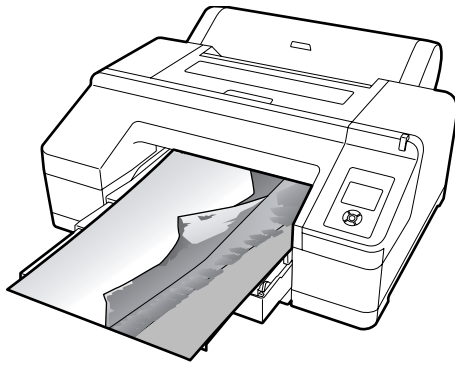

There are two ways to print a banner.

Printer Driver Source	Supported Applications
Roll paper	Document preparation software, image editing software, and so on*
Roll paper (Banner)	Applications that support banner printing

\* Create print data at a size supported by the given application while maintaining the printing length and width ratio.

The following printing sizes are available.

The minimum paper size supported by this printer is 203 (width) x 254 (length) mm. If you create a user-defined paper size smaller than this minimum size, you can print on paper that is larger than 203 (width) x 254 (length) mm, and then trim the margins to the size you require.

Available Media Sizes	
Width	89 to 432 mm
Length*	Windows: Max. 15000 mm Mac OS X: Max. 15240 mm

\* The paper length can be longer if using applications that support banner printing. However, the actual print size depends on the application, the paper size loaded in the printer, and the computer environment.

## Making Settings in Windows

**1** In the printer driver's Main screen, select **Media Type**.

[“Basic Printing Methods\(Windows\)” on page 43](#)

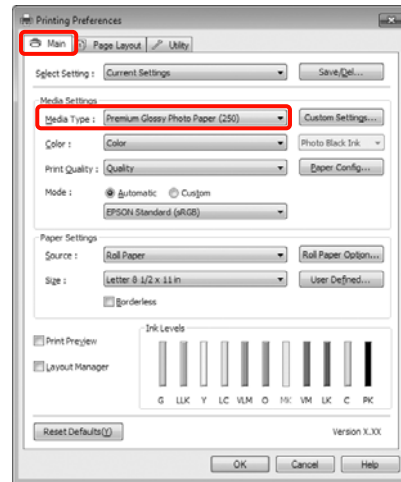

**2** Select **Roll Paper** or **Roll Paper (Banner)** from the **Source** list.

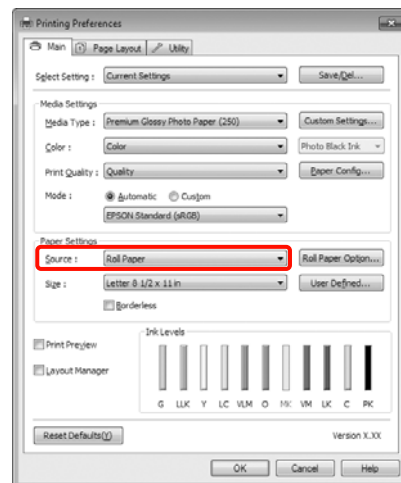

**Tip:**

- You can only use **Roll Paper (Banner)** for applications that support banner printing.
- Selecting **Roll Paper (Banner)** sets the top and bottom margins of the paper to 0 mm.

## Printing Varieties

- 3** Click **Roll Paper Option**, and then select **Normal Cut** or **Off** from the **Auto Cut** list.

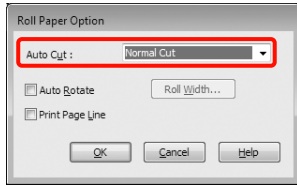

- 4** Click **User Defined** and match the paper size to the size of the data if necessary.

**Tip:**

If you are using applications that support banner printing, you do not need to set **User Defined Paper Size** if you select **Roll Paper (Banner)** as the **Source**.

- 5** Click the **Page Layout** tab, and select **Reduce/Enlarge**, and then select **Fit to Page** or **Fit to Roll Paper Width**.

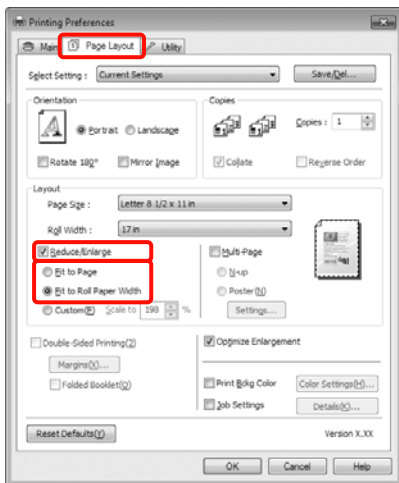

**Tip:**

If you are using applications that support banner printing, you do not need to set **Reduce/Enlarge** if you select **Roll Paper (Banner)** as the **Source**.

- 6** Select the size of the data created by the application from the **Page Size** list, and select the roll paper width loaded in the printer for the **Roll Width** or **Output Paper**.

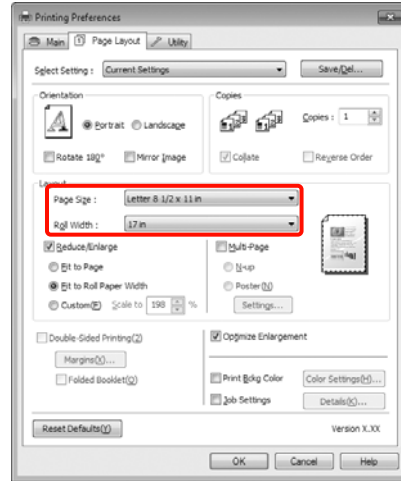

**Tip:**

Settings in applications that support banner printing are ignored.

- 7** Make sure the **Optimize Enlargement** check box is selected.

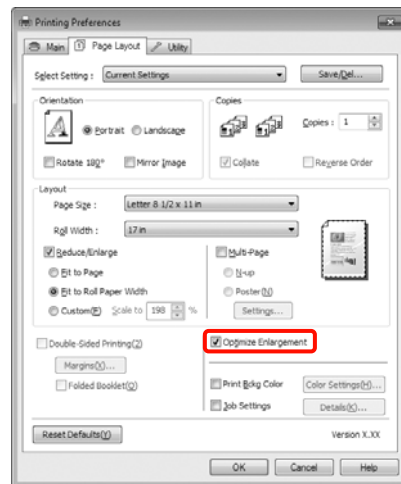

- 8** Check other settings, and then start printing.

## Printing Varieties

### Making Settings for Mac OS X

**1** When the Print screen is displayed, select the size of the data created with the application in **Paper Size**.

When using Mac OS X 10.4, or if items on the Page Setup screen are not displayed on the Print screen due to the application being used in Mac OS X 10.7, 10.6, or 10.5, display the Page Setup screen and make settings.

[“Basic Printing Methods\(Mac OS X\)” on page 44](#)

You can also perform borderless banner printing by selecting the **Paper Size** as shown below. Where XXXX is the actual paper size, such as A4.

XXXX (Roll Paper - Banner): Prints a 0 mm margin at the top and bottom, and a 3 mm margin on the left and right.

XXXX (Roll Paper - Borderless Banner): The printer driver expands the print area by approximately 3 mm to the left and right in regards to the paper width so that there is no 3 mm margin on the left and right. Therefore, you need to create data that is 3 mm wider than the paper size on the left and right in advance. The top and bottom margins are 0 mm.

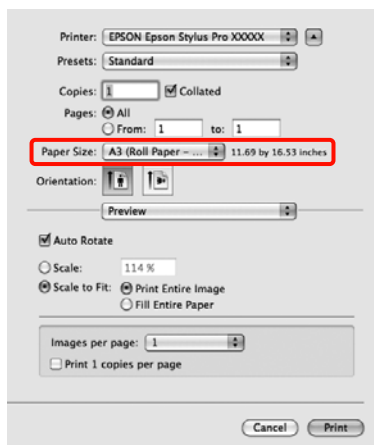

Select **Manage Custom Sizes** from the **Paper Size** list, and then set the paper size.

**2** Make settings in **Scale** to enlarge the size of the document you created in your application to the size of the paper you want to print on.

If **Scale** is not displayed on the Print screen, open the Page Setup screen, and then make the settings.

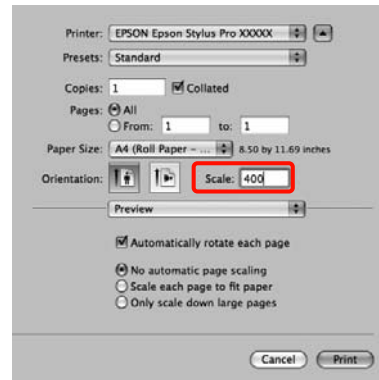

You can now print as normal.



Printing Varieties

# Layout Manager (Windows only)

The Layout Manager function allows you to place multiple pieces of print data created in different applications on the paper freely and print them at once.

You can create a poster or display material by placing multiple pieces of print data where you like. Also, Layout Manager allows you to use paper effectively.

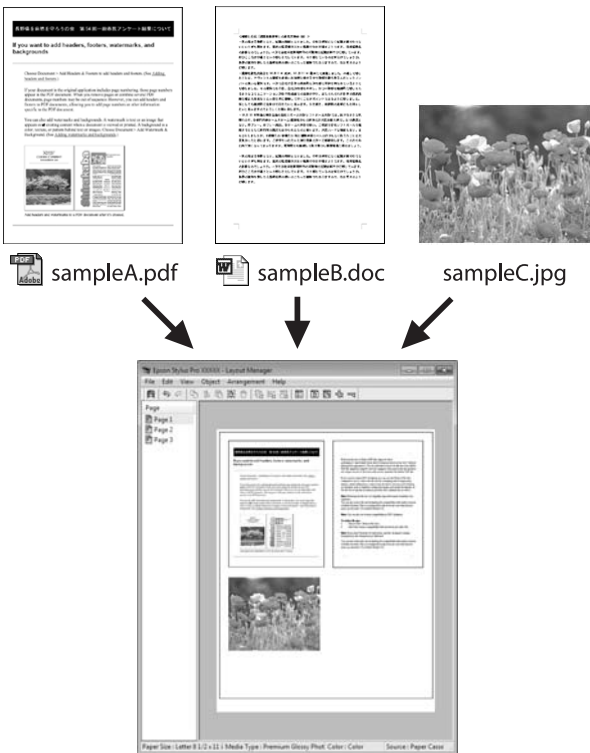

The following is a layout example.

## Placing multiple data items

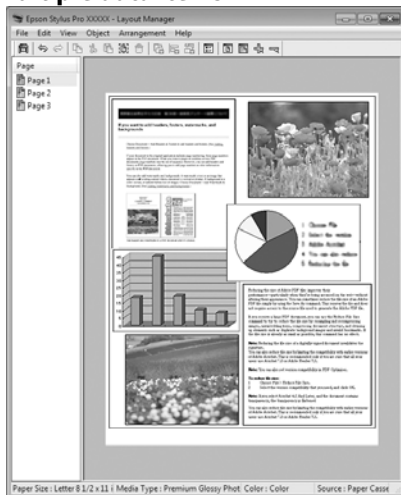

## Placing the same data

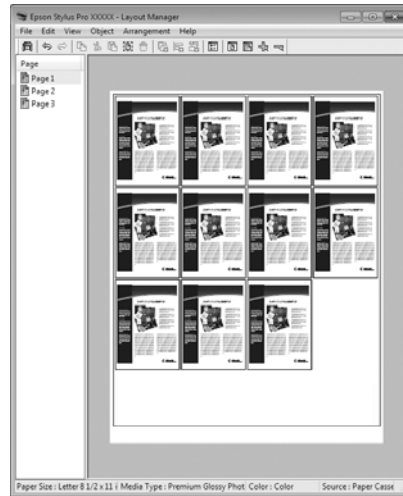

## Placing data freely

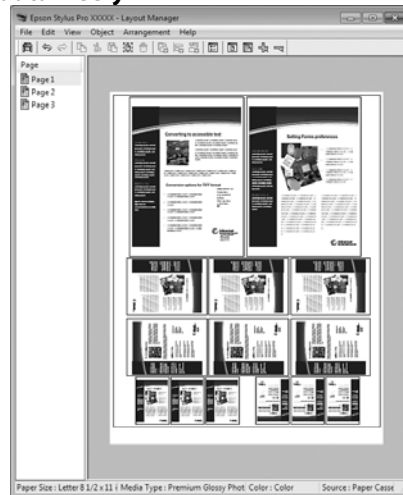

## Placing data on roll paper



Printing Varieties

Setting Procedures for Printing

- 1 Check that the printer is connected and ready to print.
- 2 Open the file you want to print in your application.
- 3 In the printer driver's **Main** screen, select **Layout Manager**, and select the size of the document made in the application as the **Size**.

“Basic Printing Methods(Windows)” on page 143

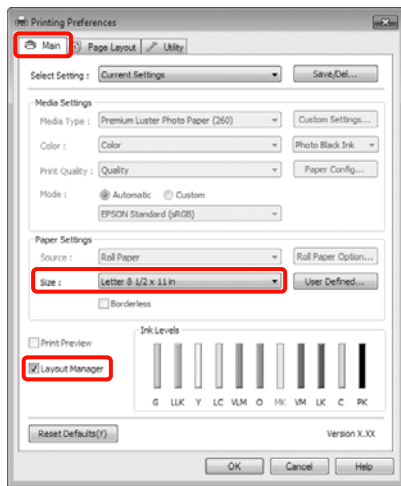

**Tip:**  
The **Size** set here is used on the **Layout Manager** screen. The actual printing paper size is set in the screen in step 7.

- 4 Click **OK**. When printing with an application, the **Layout Manager** screen opens.  
  
The print data is not printed, but one page is placed on the paper of the **Layout Manager** screen as one object.
- 5 Leave the **Layout Manager** screen open and repeat steps 2 to 4 to arrange the next pieces of data.

The objects are added to the **Layout Manager** screen.

- 6 Arrange the objects on the **Layout Manager** screen.

You can drag objects to move and resize them, use tool buttons and the **Objects** menu to align and rotate objects on the **Layout Manager** screen.

You can resize and replace whole objects in the Preference or Arrangement Settings screens.

See the **Layout Manager** screen help for more details on each function.

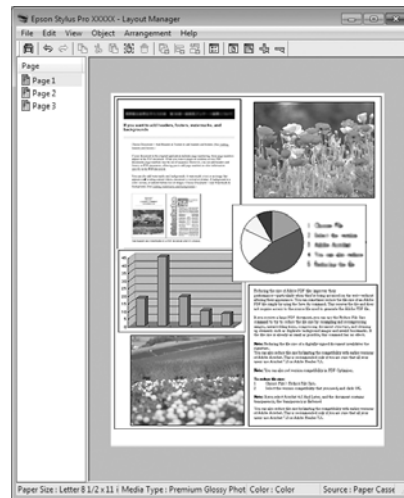

- 7 Click **File - Properties**, and make print settings on the printer driver screen.

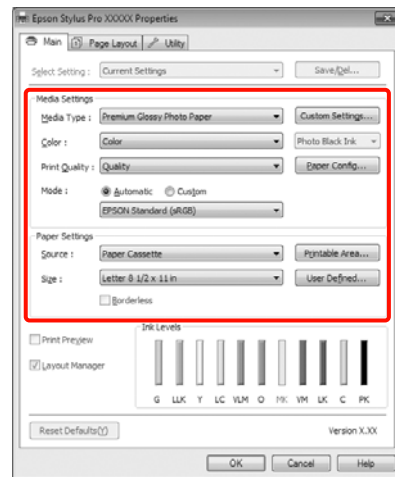

Set **Media Type**, **Source**, **Size**, and so on.

- 8 Click the **File** menu on the **Layout Manager** screen, and then click **Print**.

Printing starts.

---

## Saving and Calling Layout Manager Settings

You can save the **Layout Manager** screen arrangement and setting contents to a file. If you need to close your application in the middle of a job, you can save it to a file and then open it later to continue your work.

### Saving

- 1 On the **Layout Manager** screen, click **File** menu and then **Save as**.
- 2 Enter the file name, select the location, and then click **Save**.
- 3 Close the **Layout Manager** screen.

### Opening saved files

- 1 Right-click the Utility shortcut icon on the Windows Taskbar () , and then click **Layout Manager** on the menu displayed.

The **Layout Manager** screen is displayed.

If the Utility shortcut icon is not displayed on the Windows Taskbar  [“Summary of the Utility Tab” on page 55](#)

- 2 On the **Layout Manager** screen, click **File** menu and then **Open**.
- 3 Select the location and open the required file.

# Color Management Printing

## About Color Management

Even when using the same image data, the original image and the displayed image may look different, and the printed results may look different to the image you see on the display. This occurs due to the difference in characteristics when input devices such as scanners and digital cameras capture colors as electronic data, and when output devices such as display screens and printers reproduce colors from the color data. The color management system is a means to adjust differences in color conversion characteristics among input and output devices. As well as applications for image processing, each operating system is equipped with a color management system, such as ICM for Windows and ColorSync for Mac OS X.

In a color management system, a color definition file called a "Profile" is used to perform color matching between devices. (This file is also called an ICC profile.) The profile of an input device is called an input profile (or source profile), and of an output device, such as a printer, is called a printer profile (or output profile). A profile is prepared for each media type in this printer's driver.

The color conversion areas by the input device and the color reproduction area by the output device differ. As a result, there are color areas that do not match even when performing color matching using a profile. In addition to specifying profiles, the color management system also specifies conversion conditions for areas where color matching failed as "intent". The name and type of intent vary depending on the color management system you are using.

You cannot match the colors on the printed results and display by color management between the input device and the printer. To match both colors, you need to perform color management between the input device and the display as well.

## Color Management Print Settings

You can perform color management printing using this printer's printer driver in the following two ways.

Choose the best method according to the application you are using, the operating system environment, the aim of the print out and so on.

### Setting color management with applications

This method is for printing from applications that support color management. All color management processes are carried out by the application's color management system. This method is useful when you want to obtain the same color management print results using a common application among different operating system environments.

 ["Setting color management with the application" on page 93](#)

### Setting color management with the printer driver

The printer driver uses the operating system's color management system and carries out all color management processes. You can make color management settings in the printer driver using the following two methods.

#### Host ICM (Windows)/ColorSync (Mac OS X)

Set when printing from applications that support color management. This is effective in producing similar print results from different applications under the same operating systems.

 ["Color management printing by Host ICM \(Windows\)" on page 94](#)

 ["Color management printing by ColorSync \(Mac OS X\)" on page 95](#)

#### Driver ICM (Windows only)

This allows you to perform color management printing from applications that do not support color management.

 ["Color management printing by Driver ICM\(Windows only\)" on page 96](#)

## Color Management Printing

### Setting profiles

Settings for the input profile, printer profile, and intent (matching method) vary between three types of color management printing since their color management engines are used differently. This is because color management usage differs between the engines. Make settings in the printer driver or application as described in the following table.

	Input profile settings	Printer profile settings	Intent settings
Driver ICM (Windows)	Printer Driver	Printer Driver	Printer Driver
Host ICM (Windows)	Application	Printer Driver	Printer Driver
ColorSync (Mac OS X)	Application	Printer Driver	Application
Application	Application	Application	Application

Printer profiles for each paper type that is needed when performing color management are installed with the printer's printer driver. You can select the profile from the printer driver's settings screen.

See the following for detailed information.

[“Color management printing by Driver ICM\(Windows only\)” on page 96](#)

[“Color management printing by Host ICM \(Windows\)” on page 94](#)

[“Color management printing by ColorSync \(Mac OS X\)” on page 95](#)

[“Setting color management with the application” on page 93](#)

### Setting color management with the application

Print using applications with a color management function. Make the color management settings in the application and disable the printer driver's color adjustment function.

- 1 Make color management settings in the applications.

Example of Adobe Photoshop CS4

Open the **Print** screen.

Select **Color Management** and then **Document**. Select **Photoshop Manages Colors** as the **Color Handling** setting, select the **Printer Profile** and the **Rendering Intent**, and then click **Print**.

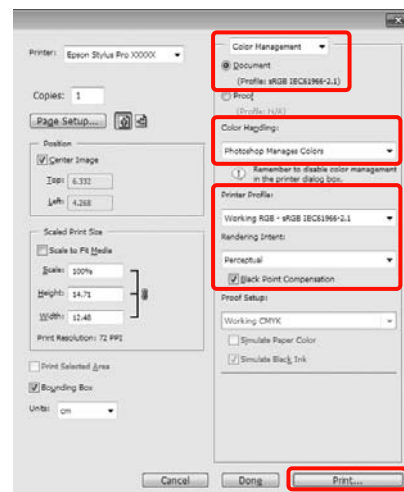

- 2 Display the printer driver's settings screen (Windows) or Print screen (Mac OS X).

Make printer driver settings.

#### For Windows

[“Basic Printing Methods\(Windows\)” on page 43](#)

#### For Mac OS X

[“Basic Printing Methods\(Mac OS X\)” on page 44](#)

**Color Management Printing**

**3** Set color management to off.

**For Windows**

In the **Main** screen, select **Custom** as the **Mode** setting, and select **Off (No Color Adjustment)**.

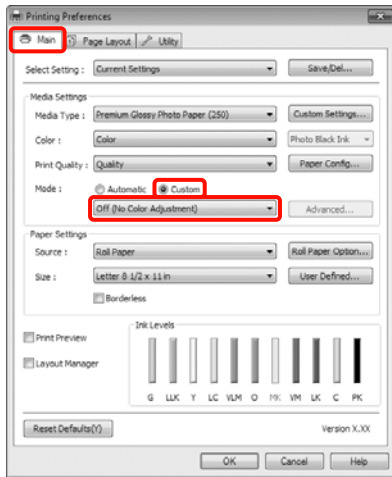

**Tip:**  
When using Windows 7/Windows Vista/Windows XP (Service Pack 2 or later and .NET 3.0), **Off (No Color Adjustment)** is automatically selected.

**For Mac OS X**

Select **Print Settings** from the list, and then select **Off (No Color Adjustment)** as the **Color Settings** setting.

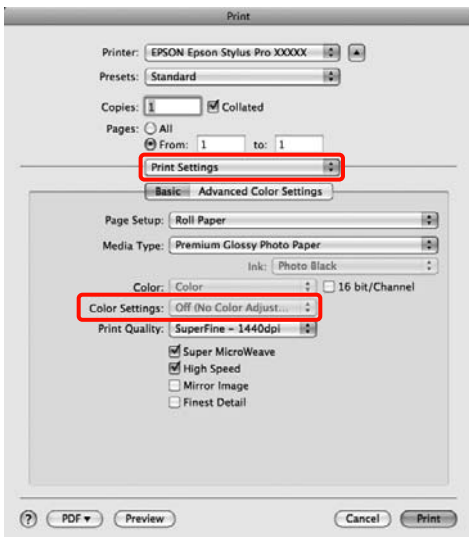

**4** Check other settings, and then start printing.

# Setting color management with the printer driver

## Color management printing by Host ICM (Windows)

Use image data in which an input profile has been embedded. Also, the application must support ICM.

**1** Make the settings for color adjustment using the application.

Depending on the type of the application, make the settings following the table below.

- Adobe Photoshop CS3 or later
- Adobe Photoshop Elements 6.0 or later
- Adobe Photoshop Lightroom 1 or later

OS	Color Management Settings
Windows 7 Windows Vista	Printer Manages Colors
Windows XP (Service Pack 2 or later and .NET 3.0 or later)	
Windows XP (other than the above)	No Color Management

In other applications, set **No Color Management**.

Example of Adobe Photoshop CS4

Open the **Print** screen.

### Color Management Printing

Select **Color Management** and then **Document**. Select **Printer Manages Colors** as the **Color Handling** setting, and then click **Print**.



When using applications without a color management function, start from step 2.

- 2 In the printer driver's **Main** screen, select **Custom** as the **Mode**, select **ICM**, and then click **Advanced**.

[“Basic Printing Methods\(Windows\)” on page 43](#)

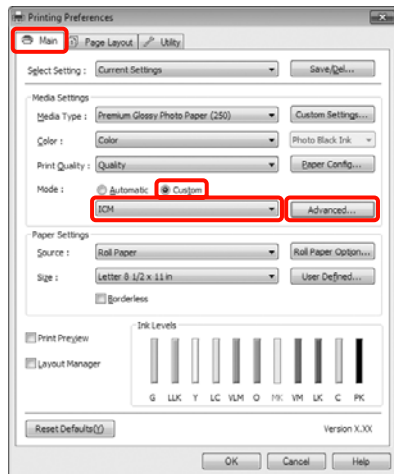

- 3 Select **Host ICM**.

When Epson special media is selected from **Media Type** in the **Main** screen, the printer profile corresponding to the media type is automatically selected and displayed in the **Printer Profile Description** box.

To change the profile, select **Show all profiles** at the bottom.

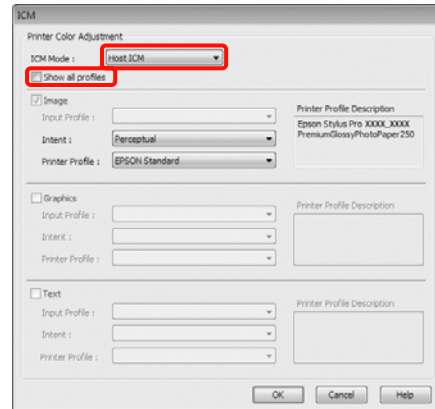

- 4 Check other settings, and then start printing.

### Color management printing by ColorSync (Mac OS X)

Use image data in which an input profile has been embedded. Also, the application must support ColorSync.

**For Mac OS X 10.7, 10.6, or 10.5**

Depending on the application, color management printing by **ColorSync** may not be supported.

- 1 Disable the color management functions in the application.

- 2 Display the Print screen.

[“Basic Printing Methods\(Mac OS X\)” on page 44](#)

- 3 Select **Color Matching** from the list, and then click **ColorSync**.

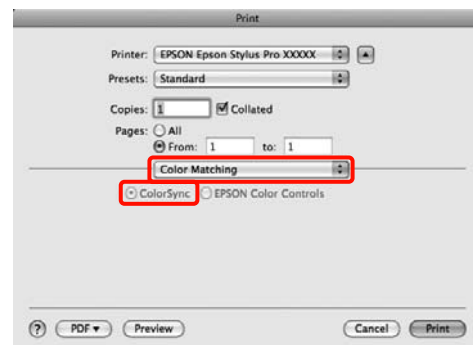

### Color Management Printing

**4** Furthermore, in Mac OS X 10.5 select **Print Settings** from the list, and then select **Off (No Color Adjustment)** from **Color Settings**.

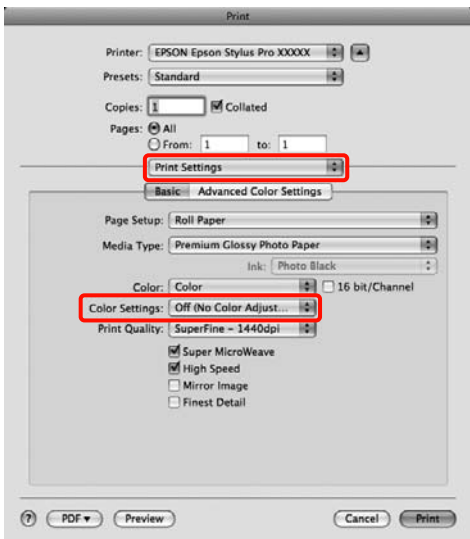

**For Mac OS X 10.4**

**1** Disable the color management functions in the application.

Depending on the type of the application, make the settings following the table below.

Applications	Color Management Settings
Adobe Photoshop CS3 or later Adobe Photoshop Lightroom 1 or later Adobe Photoshop Elements 6 or later	Printer Manages Colors
Other applications	No Color Management

Example of Adobe Photoshop CS4

Open the **Print** screen.

Select **Color Management** and then **Document**. Select **Printer Manages Colors** as the **Color Handling** setting, and then click **Print**.

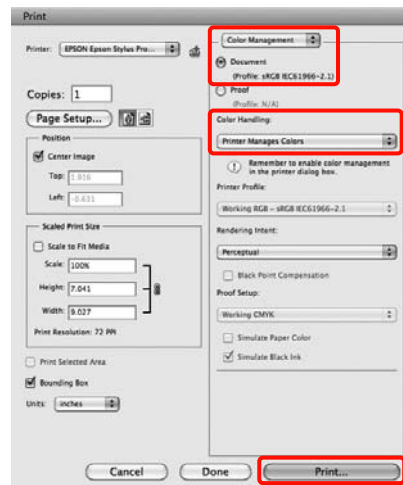

**2** Display the Print screen, select **Print Settings** from the list, and then select **ColorSync** as the **Color Settings**.

[“Basic Printing Methods\(Mac OS X\)” on page 44](#)

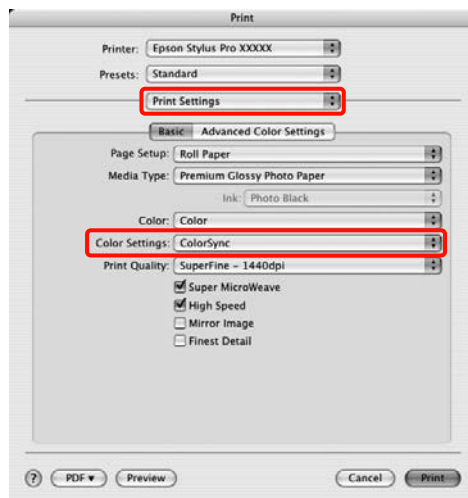

**3** Check other settings, and then start printing.

### Color management printing by Driver ICM (Windows only)

The printer driver uses its own printer profiles to perform color management. You can use the following two color correction methods.



### Color Management Printing

Driver ICM (Basic)

Specify one type of profile and intent for processing the entire image data.

Driver ICM (Advanced)

The printer driver distinguishes the image data into the **Image**, **Graphics**, and **Text** areas. Specify three types of profiles and intents for processing each area.

#### When using applications featuring a color management function

Make the settings for color processing using the application before making printer driver settings.

Depending on the type of the application, make the settings following the table below.

Adobe Photoshop CS3 or later  
 Adobe Photoshop Elements 6.0 or later  
 Adobe Photoshop Lightroom 1 or later

OS	Color Management Settings
Windows 7 Windows Vista	Printer Manages Colors
Windows XP (Service Pack 2 or later and .NET 3.0 or later)	
Windows XP (other than the above)	No Color Management

In other applications, set **No Color Management**.

Example of Adobe Photoshop CS4

Open the **Print** screen.

Select **Color Management** and then **Document**. Select **Printer Manages Colors** as the **Color Handling** setting, and then click **Print**.



**1** From **Mode** in the printer driver's **Main** screen, select **Custom** as the mode, select **ICM**, and then click **Advanced**.

[“Basic Printing Methods\(Windows\)” on page 43](#)

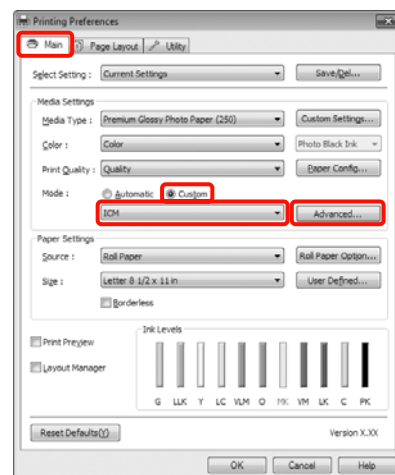

**2** From **ICM Mode** in the **ICM** screen, select **Driver ICM (Basic)** or **Driver ICM (Advanced)**.

If you select **Driver ICM (Advanced)**, you can specify the profiles and intent for each image such as photos, graphics, and text data.

Intent	Explanation
Saturation	Keeps the current saturation unchanged and converts the data.

### Color Management Printing

Intent	Explanation
Perceptual	Converts the data so that a more visually natural image is produced. This feature is used when a wider gamut of color is used for image data.
Relative Colorimetric	Converts the data so that a set of color gamut and white point (or color temperature) coordinates in the original data match their corresponding print coordinates. This feature is used for many types of color matching.
Absolute Colorimetric	Assigns absolute color gamut coordinates to the original and print data and converts the data. Therefore, color tone adjustment is not performed on any white point (or color temperature) for the original or print data. This feature is used for special purposes such as logo color printing.

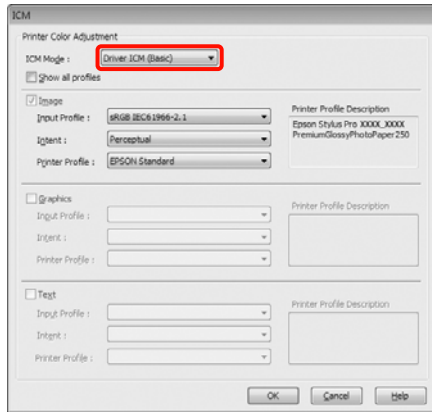

**3** Check other settings, and then start printing.

---

# Using the Control Panel Menu

---

## Menu Operations

Primarily, the following two menus can be set from the control panel.

### □ Menu

You can display or print environmental settings such as custom paper settings when using non-Epson special media, and the printer status.

Normally, perform settings for printing in the printer driver or application.

You can display the Menu by pressing the ► button when the printer is in ready status or when no paper is loaded.

### □ Ink Menu

You can perform head cleaning or a nozzle check or change the type of black ink.

You can display the Ink Menu by pressing the  button when the printer is in ready status or when no paper is loaded.

If the  button is pressed while printing is paused then you can only perform head cleaning or auto nozzle check from the Ink Menu at that time.

You can navigate both menus in roughly the same way as described below. Only one difference is that you need to press the OK button after selecting a menu item to go to the next menu in the Ink Menu. Make sure to check the guide at the bottom of the screen.

### Using the Control Panel Menu

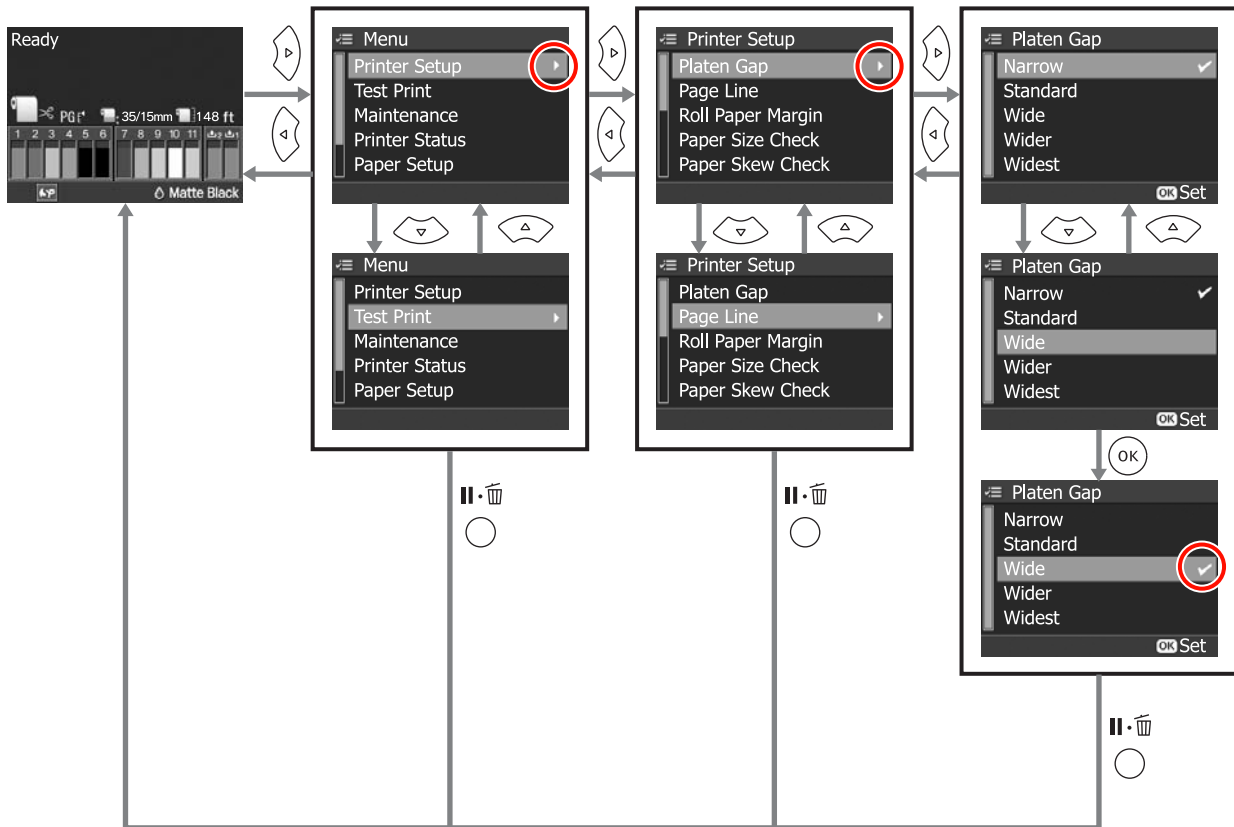

The following section explains using the Menu as an example.







## Using the Control Panel Menu

# Menu List

The following items and parameters can be set and executed in the Menu. See the reference pages for more details on each item.

Menu	Item	Parameter
Printer Setup  "Printer Setup menu" on page 103	Platen Gap	Narrow, Standard, Wide, Wider, Widest
	Page Line	On, Off
	Roll Paper Margin	Default, Top/Bottom 15mm, Top 35/Bottom 15mm, 3mm, 15mm
	Paper Size Check	On, Off
	Paper Skew Check	On, Off
	Refresh Margin	On, Off
	Auto Nozzle Check	On:Periodically, On:Every Job, Off
	Print Nozzle Pattern	Off, On:Every Page, On:Every 10 Pages
	Change Black Ink	Manual, Auto
	Auto Roll Feeding	On, Off
	Initialize Settings	Execute
Test Print  "Test Print menu" on page 105	Status Sheet	Print
	Network Status Sheet	Print
	Job Information	Print
	Custom Paper	Print
Maintenance  "Maintenance menu" on page 105	Cutter Adjustment	-120 mil to +120 mil(-3.0 mm to +3.0 mm)
	Clock Setting	MM/DD/YY HH:MM
Printer Status  "Printer Status menu" on page 106	Version	xxxxxxx,x.xx,xxxx
	Ink Level	(Ink color) [E ***** F]
	Maintenance Box	1 [E ***** F], 2 [E ***** F]
	Job History	No. 0 to No. 9, Ink xx.x ml, Paper xxxxxx cm <sup>2</sup>
	Total Prints	xxxxxx Pages
	myEpsonPrinter Status	Not Started, Disabled, Enabled Last Uploaded MM/DD/YY HH:MM GMT, (Not Uploaded)

## Using the Control Panel Menu

Menu	Item	Parameter
Paper Setup  "Paper Setup menu" on page 106	Roll Paper Remaining	Remaining Paper Setup, Roll Paper Length, Roll Length Alert
	Cut Sheet Remaining	Sheet Number, Sheet Number Alert
	Paper Type	Photo Paper, Proofing Paper, Fine Art Paper, Matte Paper, Plain Paper, -, Custom Paper, No Paper Selected
	Custom Paper	Paper No. 1 to 10
Head Alignment  "Head Alignment menu" on page 110	Paper Thickness	Paper Type, Paper Thickness
	Alignment	Auto, Manual
Network Setup  "Network Setup menu" on page 111	Network Settings	Hide, Show
	IP Address Setting	Auto, Panel
	IP,SM,DG Setting	IP Address: 000.000.000.000 to 255.255.255.255 Subnet Mask: 000.000.000.000 to 255.255.255.255 Default Gateway: 000.000.000.000 to 255.255.255.255
	Bonjour	On, Off
	WSD	Off, On
	Init Network Setting	Execute
SpectroProofer  "SpectroProofer menu" on page 111	Status Information	Device Version:ILS20EP, Calibration Tile S/N, Device Temperature, Firmware Version, Air Temperature, Backing Color, Calibration Status

## Using the Control Panel Menu



## Details of the Menu

### Printer Setup menu

The factory setting is  .

Item	Parameter	Explanation
Platen Gap	Narrow	Select the platen gap which is the distance between the print head and the paper.
	Standard	Normally, select <b>Standard</b> . Select a wider setting if printed images are smeared. If, upon performing head alignment you feel that it is still not completely aligned, select <b>Narrow</b> .
	Wide	
	Wider	This setting is cleared when the printer is turned off. When the printer is turned back on this setting operates at the factory setting.
	Widest	If <b>Platen Gap</b> is set for <b>Custom Paper</b> from the Paper Setup menu, the setting for <b>Custom Paper</b> is given priority.
Page Line	On	Select whether to print ( <b>On</b> ) or not to print ( <b>Off</b> ) a page line (line along which to cut) on the roll paper. This is not printed on cut sheets.
	Off	A vertical line may be printed when the roll paper width that is specified on the computer is smaller than the width of the roll paper that is loaded in the printer.
Roll Paper Margin	Default	Select margins for roll paper.
	Top/Bottom 15mm	When set to <b>Default</b> , the top and bottom margins are 15 mm, and the left and right margins are 3 mm.
	Top 35/Bottom 15mm	Except for <b>15mm</b> , the left and right margins for all other settings are 3 mm.
	3mm	 <a href="#">"Printable area" on page 46</a>
	15mm	
Paper Size Check	On	Select whether to detect ( <b>On</b> ) or not to detect ( <b>Off</b> ) the paper width and top edge of the paper.
	Off	When set to <b>Off</b> , the printer prints beyond the edges of the paper if the image is larger than the loaded paper. However, the following restrictions apply. We generally recommend to operate with this setting set to <b>On</b> . <ul style="list-style-type: none"> <li><input type="checkbox"/> The top margin may become wide.</li> <li><input type="checkbox"/> If borderless printing is performed, an error is displayed and printing cannot be performed.</li> <li><input type="checkbox"/> When <b>Remaining Paper Setup</b> is set to <b>On</b> the remaining paper may not be detected correctly.</li> <li><input type="checkbox"/> If it prints beyond the edges of the paper, the inside of the printer becomes dirty with ink. If printing is continued in this state the outside of the printer may become soiled with ink.</li> </ul>

## Using the Control Panel Menu

Item	Parameter	Explanation
Paper Skew Check	On	This setting is effective for roll paper only.
	Off	Select whether to display <b>(On)</b> or not to display <b>(Off)</b> an error message on the control panel's screen and whether or not stop printing if the paper is not straight.  We recommend using <b>On</b> , because if the paper is not fed straight, a paper jam could occur.
Refresh Margin	On	This setting is effective for roll paper only.
	Off	After printing borderless on all edges, select whether to cut automatically <b>(On)</b> or not to cut <b>(Off)</b> the leading edge of the paper to remove any marks which may have been left in preparation for the next job when printing with margins.  When the optional SpectroProofer is installed, this setting is automatically set to <b>Off</b> and is not displayed in the Menu.
Auto Nozzle Check	On:Periodically	Select the timing for the auto nozzle check.
	On:Every Job	When <b>On:Periodically</b> is set, Auto Nozzle Check is carried out according to the timing determined by the printer.
	Off	When <b>On:Every Job</b> is set, Auto Nozzle Check is carried out before printing each job.   <a href="#">"Adjusting the Print Head" on page 113</a>
Print Nozzle Pattern	Off	This setting is effective for roll paper only.
	On:Every Page	Select whether to print <b>(On)</b> or not to print <b>(Off)</b> the nozzle check pattern. When set to <b>On</b> , a nozzle check pattern is printed on the leading edge of the roll paper. Check the nozzle check pattern and determine if there are any dots missing when printing.
	On:Every 10 Pages	
Change Black Ink	Manual	This function is enabled when printing to paper that supports both matte black and photo black ink.
	Auto	Select between automatically switching black ink <b>(Auto)</b> or not automatically switching black ink <b>(Manual)</b> when switching the type of black ink from the printer driver.  When <b>Auto</b> is selected, the printer automatically switches to the type of black ink set in the printer driver, even if the type of black ink set in the printer driver and the printer itself do not match.  A confirmation message is displayed when <b>Manual</b> is selected. If you choose to continue printing, the printer switches to the type of black ink specified in the printer driver, and then performs the printing operation.  When printing to paper that has a specific type of supported black ink, you cannot set the type of black ink from the printer driver regardless of this setting. You must set the type of black ink that is compatible with your paper from the printer's Ink Menu before printing.  <a href="#">"Changing the Type of Black Ink" on page 47</a>



## Using the Control Panel Menu

Item	Parameter	Explanation
Auto Roll Feeding	On	<p>When using the Epson special media UltraSmooth Fine Art Paper you must set this to <b>Off</b> before loading the paper. If set to <b>On</b> for UltraSmooth Fine Art Paper, the roller of the paper presser may leave a mark on the surface of the paper.</p> <p>When using paper other than UltraSmooth Fine Art Paper, set it to <b>On</b>.  <a href="#">“Setting Auto Roll Paper Feeding” on page 27</a></p> <p>When this is set to <b>On</b>, the following operations are available. When <b>Off</b> is selected, an error occurs and the following operations cannot be performed.</p> <ul style="list-style-type: none"> <li><input type="checkbox"/> When a paper cassette is specified for printing from the printer driver and a print job is executed, roll paper is automatically set to saved mode and printing is performed by feeding from the paper cassette, even if roll paper is being fed to the printer. From the next time, when roll paper is specified from the printer driver, roll paper is automatically fed and printing is performed.</li> <li><input type="checkbox"/> Roll paper is automatically set to saved mode and cut paper can be fed when <b>Cut Sheet</b> is also selected from the Paper Type screen. After printing the cut sheets, and <b>Roll Paper / Cut</b> or <b>Roll Paper / No Cut</b> is selected from the Paper Type screen, roll paper is automatically fed from saved mode.</li> </ul>
	Off	
Initialize Settings	Execute	This restores the settings in the <b>Printer Setup</b> menu and the Paper Suction set from the control panel back to their factory settings.

## Test Print menu

Item	Parameter	Explanation
Status Sheet	Print	You can print the current status of the printer.
Network Status Sheet	Print	You can print the current network status.
Job Information	Print	You can print the job information saved in the printer (up to 10 jobs.)
Custom Paper	Print	You can print using the information stored in <b>Custom Paper</b> .

## Maintenance menu

Item	Parameter	Explanation
Cutter Adjustment	-120 mil to +120 mil(-3.0 mm to +3.0 mm)	You can fine tune the cut position when printing to roll paper with no margins in all directions. In increments of 8 mil (0.2 mm).
Clock Setting	MM/DD/YY HH:MM	You can set year, month, date, hour, and minute to the internal clock. The time set here is used when printing job information.

## Using the Control Panel Menu

### Printer Status menu

You can check the printer's current status as displayed on the screen.

Item	Display	Explanation
Version	xxxxxxx,x.xx,xxxx	You can see the firmware version.
Ink Level	(Ink color) [E ***** F]	You can see the status of each ink cartridge. The asterisks (*) disappear one at a time for every 10 % of ink consumed. You can confirm the remaining ink level more reliably than with the ink cartridge icon on the screen.  When you replace an ink cartridge, the remaining ink level is automatically reset.
Maintenance Box	1 [E ***** F]	You can see the space in Maintenance Box 1 and 2. The asterisks (*) disappear one at a time for every 10 % of free space used up. You can confirm the free space more reliably than with the Maintenance Box icon on the screen.  When you replace a Maintenance Box, the remaining space is automatically reset.
	2 [E ***** F]	
Job History	No. 0 to No. 9 Ink xx.x ml Paper xxxxxx cm2	You can see ink consumption (in milliliters) and total printing size (width x height, in square centimeters ) for each print job. A maximum of 10 jobs can be displayed. The latest job number is No. 0.
Total Prints	xxxxxx Pages	You can see the total number of pages you have printed (up to 6 figures).
myEpsonPrinter Status	Not Started, Disabled, Enabled	You can see if myEpsonPrinter is enabled or disabled. If it is enabled, the last uploaded time is displayed.
	Last Uploaded (Not Uploaded), MM/DD/YY HH:MM GMT	This function is not supported in some areas and some countries.

### Paper Setup menu



Set the amount of remaining roll paper and the media type.

The factory setting is .

## Using the Control Panel Menu

Item		Parameter	Explanation
Roll Paper Remaining	Remaining Paper Setup	Off	Select whether to display/record ( <b>On</b> ) or not to display/record ( <b>Off</b> ) the amount of remaining roll paper.
		On	This setting is displayed only when roll paper is not loaded in the printer.  When set to <b>On</b> , the parameters <b>Roll Paper Length</b> and <b>Roll Length Alert</b> are available in the menu, and the settings can be made. These parameters determine the amount of remaining roll paper that is displayed on the control panel's screen. Also, when you press the $\frac{\%}{100}$ button, each parameter for the amount of remaining roll paper, the <b>Roll Length Alert</b> , and the <b>Paper Type</b> are printed on the roll paper as a barcode. When replacing the current roll paper with another type of roll paper, if a barcode is already printed on the roll paper being replaced, the barcode is read automatically and the paper settings are updated allowing you to complete the replacement efficiently.
	Roll Paper Length	15 to 300 ft (5.0 to 99.5 m)	Set the total length for the roll paper within a range from 15 to 300 ft (5.0 to 99.5 m). You can set in 1 ft (0.5 m) increments.
	Roll Length Alert	4 to 50 ft (1 to 15 m)	Set within a range from 4 to 50 ft (1 to 15 m) to display a warning when the amount of remaining roll paper drops below that limit. You can set in 1 ft (0.5 m) increments.
Cut Sheet Remaining	Sheet Number	10 to 990	This setting is displayed only when <b>Cut Sheet Remaining</b> is set to <b>On</b> from Maintenance Mode. <a href="#">↗ "Maintenance Mode" on page 159</a>
	Sheet Number Alert	1 to 50	Set the number of pages for the paper cassette in a range from 10 to 990 sheets in increments of 10 pages for the <b>Sheet Number</b> setting.  You can set at how many pages left in the paper cassette should a warning be displayed by entering a number between 1 and 50 pages in increments of 1 page for the <b>Sheet Number Alert</b> setting.  The number of cut sheets remaining is displayed on the control panel's screen based on the settings you choose for <b>Sheet Number</b> and <b>Sheet Number Alert</b> .
Paper Type		Photo Paper	You can select the media type loaded.
		Proofing Paper	
		Fine Art Paper	
		Matte Paper	
		Plain Paper	
		Custom Paper	
		No Paper Selected	

## Using the Control Panel Menu

Item	Parameter	Explanation
Custom Paper (1 to 10)	Paper No. 1 to 10	<p>When using non-Epson media, you can save the custom paper settings according to the media characteristics of that paper which are Platen Gap, Paper Thickness, Paper Feed Adjust, Drying Time, and Paper Suction. You can save up to 10 by assigning them to <b>Paper No.1</b> to <b>Paper No.10</b>. After saving, you can print using the saved settings simply by specifying the Paper Number (Paper No.). Even when the printer is turned off, the saved settings are retained.</p> <p>See the following for more details on the parameters.</p> <p> <a href="#">"Custom Paper" on page 108</a></p> <p>As well as this method, there are another two methods for creating Custom Paper settings.</p> <ul style="list-style-type: none"> <li><input type="checkbox"/> Setting with EPSON LFP Remote Panel 2           <p>EPSON LFP Remote Panel 2 is a utility for performing various maintenance procedures for the printer. You can find it on the Software Disc supplied with this printer. By using EPSON LFP Remote Panel 2, you can easily save Custom Paper settings in the printer's memory. See the EPSON LFP Remote Panel 2 help for details.</p> </li> <li><input type="checkbox"/> Setting and saving with the printer driver           <p>Windows: Set <b>Media Settings</b> items in the <b>Main</b> screen and then save.</p> <p> <a href="#">"Saving media settings" on page 53</a></p> <p>Mac OS X: Set in the <b>Paper Configuration</b> screen.</p> <p>See the printer driver help for more details.</p> </li> </ul> <p>When Custom Paper settings are made both in the printer's Menu and in the printer driver, the printer driver settings are given priority when printing from the printer driver.</p>

## Custom Paper

When making settings, check the paper's characteristics in advance. For the paper's characteristics, check the paper's manual or with your local dealer.

You can check the saved settings in **Test Print - Custom Paper** from the Menu.

Before making the settings, load the paper that you are going to use. Also, make sure to select the paper from **Paper Type** first, and then make the **Platen Gap** setting and so on.

If colors in printed images on the custom paper are uneven, use unidirectional printing. For unidirectional printing, select the **Main** screen - **Print Quality - Quality Options** from the printer driver (for Windows), or **Print Settings** (for Mac OS X), and then clear the **High Speed** check box.

### Using the Control Panel Menu

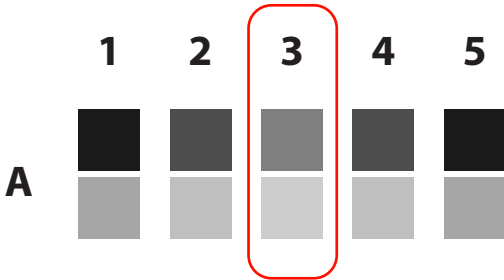
Item	Parameter	Explanation
Paper Type	Photo Paper	You can select the media type that is the closest to the paper you are using.
	Proofing Paper	
	Fine Art Paper	
	Matte Paper	
	Plain Paper	
Platen Gap	Narrow	🔗 <a href="#">"Printer Setup menu" on page 103</a>
	Standard	
	Wide	
	Wider	
	Widest	
Thickness Pattern	Print	Print a pattern to detect the thickness of the loaded paper. Select the pattern number with the least misalignment from the print results.
Paper Feed Adjust A	Pattern	<p>Use this setting if you are unable to resolve banding issues (horizontal striped lines or uneven colors) in the standard print area (for cut sheets, the area excluding the 1 to 2 cm strip at the bottom of the paper) even after head cleaning or head alignment.</p> <p><input type="checkbox"/> <b>Pattern</b></p> <p>This method allows you to correct by visually checking a printed pattern and entering a correction value.</p> <p>Check for the lightest colored pattern in lines A to F on the printed adjustment pattern.</p> <p>In the following example, "3" should be selected as it is the lightest.</p> <div style="text-align: center;">  </div> <p>Enter the confirmed number for each entry screen for lines A to F.</p> <p><input type="checkbox"/> <b>Value</b></p> <p>You can change the value based on the banding in the printed material.</p> <p>The correction value (-0.70 to + 0.70%) is set at a rate of one meter per paper feed. Because a black band occurs (dark colored stripe) if too little paper is fed, adjust it in a + direction. Because a white band occurs (a white or light colored stripes) if too much paper is fed, adjust it in a - direction.</p>
	Value	

## Using the Control Panel Menu

Item	Parameter	Explanation
Paper Feed Adjust B	-0.70 % to +0.70 %	Adjusts the paper feed adjustment value for the 1 to 2 cm region at the bottom of the cut sheets (the bottom area of the paper). This setting is ignored when printing on roll paper.  Adjust this value if you notice any banding in this region of the paper.
Drying Time	0.0 sec to 10.0 sec	You can set the time to pause the print head between each print head pass to allow the ink to dry. Depending on the ink density or paper type, the ink may take a while to dry. If the ink blurs on the paper, set a longer time for drying the ink.
Paper Suction	Standard	This printer prints by sucking the paper using an appropriate amount of pressure depending on the paper to keep the paper and the print head at an even distance. Set the paper suction value here.  For thin paper, if the suction power is too strong, the distance between the print head and the paper is too wide, which may cause print quality to decline or the paper may not feed correctly. If this happens, lower the paper suction. The suction power is weakened when the parameter is lowered.
	-1 to -4	
Set Roll Paper Tension	Normal	If wrinkles appear in the paper while printing, select <b>High</b> or <b>Extra High</b> .
	High	
	Extra High	
Remove Skew	On	Select whether to enable ( <b>On</b> ) or disable ( <b>Off</b> ) paper skew reduction.
	Off	

## Head Alignment menu

You can perform print head alignment. See the following for more details on Head Alignment.

 [“Correcting Print Misalignment \(Print Head Alignment\)” on page 117](#)

Item	Parameter	Explanation
Paper Thickness	Paper Type	You can set the thickness of the paper being used. When using Epson special media, select from <b>Paper Type</b> .  If you use non-Epson special media, set the <b>Paper Thickness</b> within a range of 4 to 60 mil (0.1 to 1.5 mm).
	Paper Thickness	
Alignment	Auto	When you select <b>Auto</b> , the printer prints an adjustment pattern. The pattern is read by the sensor and the optimum adjustment value is registered automatically in the printer. When you select <b>Manual</b> , you need to check the print results and enter the value for alignment.
	Manual	

## Using the Control Panel Menu

### Network Setup menu

You can make settings for the network connection. After setting the items, press the ◀ button to return to the previous screen, and then the network is reset and a network connection is available after 40 seconds. This setting is not displayed while resetting.

The factory setting is .

Item	Parameter	Explanation
Network Settings	Hide	The following items only appear when <b>Show</b> is selected.
	Show	
IP Address Setting	Auto	Select whether to use DHCP to set the IP address ( <b>Auto</b> ), or to set the address manually ( <b>Panel</b> ). When you select <b>Panel</b> , the <b>IP,SM,DG Setting</b> below is displayed.
	Panel	
IP,SM,DG Setting	You can set the IP address, Subnet Mask, and Default Gateway. Contact your system administrator for detailed information.	
Bonjour	On	Select whether the network interface uses Bonjour ( <b>On</b> ) or not ( <b>Off</b> ).
	Off	
WSD	Off	Select whether the network interface uses WSD ( <b>On</b> ) or not ( <b>Off</b> ).
	On	
Init Network Setting	Execute	You can restore the network settings to the factory settings.

### SpectroProofer menu

These settings are only available when the optional SpectroProofer is installed.

Item	Parameter	Explanation
SpectroProofer	Status Information	Displays the status for each item (Device Version:ILS20EP, Calibration Tile S/N, Device Temperature, Firmware Version, Air Temperature, Backing Color, and Calibration Status) of the installed SpectroProofer. However, when the printer is in sleep mode, the temperature or the air temperature are not displayed.

## Using the Control Panel Menu

## Ink Menu Table

The settings and executable actions that can be performed on the Ink Menu are as follows.

Executing **Cancel** closes the Ink Menu.

See the following for more details on head cleaning and nozzle check.

 [“Adjusting the Print Head” on page 113](#)

Item	Parameter	Explanation
Auto Cleaning	No	When <b>Yes</b> is selected, Auto Nozzle Check is performed. If any clogs are detected, head cleaning is performed on the row of nozzles determined to be clogged.
	Yes	
Manual Cleaning	C/VM, PK(MK)/LK, O/G, LLK/Y, VLM/LC, All Colors, and All Colors (Powerful)	Select the print head to perform head cleaning on and whether you want to perform normal cleaning or power cleaning to begin the head cleaning process.  Power cleaning is a more powerful head cleaning process which should be used for any nozzles that fail to unclog even after performing multiple normal cleanings.
Nozzle Check	Auto Nozzle Check	Performs an Auto Nozzle Check. The results of the check are displayed on the control panel's screen. If a clog is detected, the clogged nozzle(s) are displayed and Auto Cleaning is performed.
	Print Check Pattern	You can print a nozzle check pattern.
Change Black Ink		You can switch the type of black ink you want to use.   <a href="#">“Changing the Type of Black Ink” on page 47</a>



# Maintenance

## Adjusting the Print Head

You need to adjust the print head if white lines appear in your print outs or if you notice the print quality has declined. You can perform the following printer maintenance functions for maintaining the print head in good condition to ensure the best print quality.

Carry out appropriate maintenance depending on the print results and situation.

### Checking for clogged nozzles

There are two methods to check for clogged nozzles; one performs a check on command while the other performs regular checks at a specified time interval.  [“Checking for clogged nozzles” on page 113](#)

#### Nozzle Check

Perform a Nozzle Check when it is needed to check for any clogs in the print head's nozzles.

There are two checking methods, as shown below.

#### Auto Nozzle Check

Uses the Auto Nozzle Check function to check for any clogs in the print head's nozzles and display the results as a message. If a clog is detected, the clogged nozzle(s) are displayed and Auto Cleaning is performed.

#### **Tip:**

- The Auto Nozzle Check function is not 100 % guaranteed to detect clogging.*
- A small amount of ink is consumed when checking for clogs.*
- Ink is consumed when cleaning is performed by Auto Cleaning.*

#### Print Check Pattern

Prints a nozzle check pattern. When checking the printed pattern, if you see banding or any gaps in the print out you should perform head cleaning.

#### Auto Nozzle Check Settings

Performs an Auto Nozzle Check at regular intervals or with every job. Auto Cleaning is performed if any clogging is detected.

#### **Cleaning the print head**

If you see banding or gaps in the print outs, perform head cleaning. The following two functions are provided for cleaning the nozzles of the print head.

 [“Cleaning the print head” on page 115](#)

#### Auto Cleaning

Performs an Auto Nozzle Check and, if any clogging is detected, head cleaning is performed on the row of nozzles where the clogging has been detected.

Whether or not head cleaning is performed again is determined by the **Auto Cleaning Times** setting from the Maintenance Mode menu. The factory setting for **Auto Cleaning Times** is once.

#### Manual Cleaning

Select the nozzles you want to clean, and whether you want to perform normal cleaning or power cleaning. Power cleaning is a more powerful head cleaning process which should be used for any nozzles that fail to unclog even after performing multiple normal cleanings.

#### **Adjusting the print head position (Print head alignment)**

If the print results appear grainy or out of focus, perform Print Head Alignment. The Print Head Alignment function corrects print misalignments.

 [“Correcting Print Misalignment \(Print Head Alignment\)” on page 117](#)

## Checking for clogged nozzles

### Nozzle Check

Although nozzle check can be performed from the computer or the printer, the cleaning procedures differ as explained below.

#### From the computer

You can print a check pattern.

## Maintenance

- From the printer

You can select from the following two types.

Auto Nozzle Check

Print Check Pattern

**Tip:**

- You cannot perform a nozzle check when the  $\Delta$  light is on.
- For **Print Check Pattern**, print with the black ink currently selected in the printer, regardless of the type of paper loaded.

When printing the pattern on glossy paper with Matte Black ink, try not to rub the printed surface as it is difficult to pigment Matte Black ink on glossy paper.

**From the computer**

Explanations in this section use the Windows printer driver as an example.

Use **Epson Printer Utility 4** for Mac OS X.

[“Epson Printer Utility 4 Functions” on page 58](#)

- 1 Make sure that the roll paper or a cut sheet of A4 size or larger is loaded in the printer.

Make sure you set the paper source and media type correctly according to the paper you use.

- 2 Click **Nozzle Check** from the **Utility** tab in the printer driver's **Properties** (or **Print Settings**) screen.

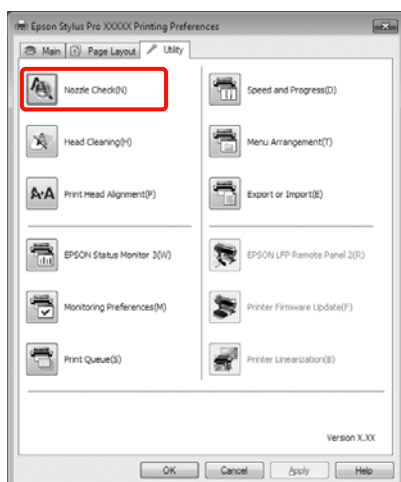

- 3 Click **Print**.

The nozzle check pattern is printed.

- 4 Check the nozzle check pattern.

If there is no problem: click **Finish**.

If there is a problem: click **Clean**.

After printing a nozzle check pattern, make sure that the nozzle check pattern printing is complete before printing your data or cleaning the print head.

**From the printer**

Buttons that are used in the following settings

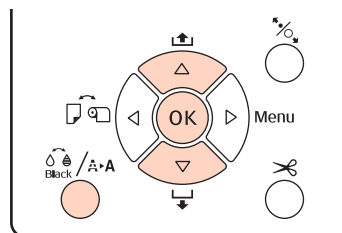

- 1 For **Print Check Pattern**, make sure that the roll paper or a cut sheet of A4 size or larger is loaded in the printer.

Make sure you set the paper type correctly according to the paper you use. [“Paper Setup menu” on page 106](#)

- 2 Press the  $\Delta$ / $\nabla$  button to display the Ink Menu.

- 3 Press the  $\nabla$ / $\Delta$  buttons to select **Nozzle Check**, and then press the OK button.

- 4 Press the  $\nabla$ / $\Delta$  buttons to select **Auto Nozzle Check** or **Print Check Pattern**, and then press the OK button.

- 5 Check the results.

**When performing Auto Nozzle Check**

After the check has completed, a message is displayed on the screen informing you of any clogs.

If the message **Nozzle clog was not detected** appears, press the OK button.

## Maintenance

If **The following nozzle(s) are clogged.** is displayed, press the /A button to start Auto Cleaning. Press the OK button to close the Ink Menu. When the Ink Menu is closed, the message informing you which nozzle(s) are clogged is removed.

### When performing Print Check Pattern

Review the printed check pattern while referring to the following section.

#### Example of clean nozzles

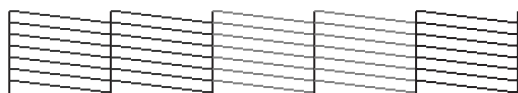

There are no gaps in the nozzle check pattern.

#### Example of clogged nozzles

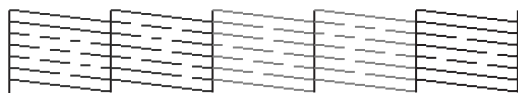

If any segments are missing in the nozzle check pattern, perform head cleaning.  [“Cleaning the print head” on page 115](#)

## Auto Nozzle Check Settings

Perform this function from the Menu.

If **Auto Nozzle Check** is set to **On:Every Job**, it is performed whenever printing starts.

When **On:Periodically** is set, auto nozzle check is performed when printing starts based on an internally determined timing system.

When changing the black ink type, auto nozzle check is performed regardless of the settings.

When clogging is detected, Auto Cleaning is performed the number of times set in the Maintenance Mode menu (the factory setting is once; three times maximum) until the clogged nozzles are cleared.

### Auto Nozzle Check Settings

 [“Printer Setup menu” on page 103](#)

## Cleaning the print head

Although head cleaning can be performed from the computer or the printer, the cleaning procedures differ as explained below.

### From the computer

You can clean all colors.

### From the printer



You can select from the following two types.

Auto Cleaning

Manual Cleaning

## Notes on head cleaning

Note the following points when performing head cleaning.

- Clean the print head only if print quality declines; for example, if the printout is blurry or the color is incorrect or missing. Ink is consumed when head cleaning is performed.
- When you perform **All Colors/All Colors (Powerful)** in **Manual Cleaning** from the printer, ink is consumed from all of the ink cartridges. Even if you are using only black inks for black and white printing, color inks are also consumed.
- You cannot perform head cleaning when the  light is on. Replace the ink cartridge with a new one first. (If there is enough remaining ink for head cleaning, you may be able to perform head cleaning from the printer's control panel.)  
 [“Replacing Ink Cartridges” on page 120](#)
- When repeating head cleaning in a short time period, the Maintenance Box may fill up quickly due to a small amount of ink evaporation in the Maintenance Box. Prepare a spare Maintenance Box if there is not enough empty space in the box.
- If the nozzles are still clogged after cleaning the print head several times, we recommend trying power cleaning.

## Maintenance

- ❑ Power cleaning consumes more ink than normal head cleaning. Check the remaining ink level in advance, and prepare a new ink cartridge before you start cleaning if the ink is low.
- ❑ If the nozzles are still clogged after performing power cleaning, turn off the printer and leave it overnight or longer. When left for some time, the clogged ink may dissolve.

If the nozzles are still clogged, contact your dealer or Epson Support.

- ❑ If a **Cleaning Error** message is displayed on the screen, see the following section to check the cause and how to solve the problem.

[“When an Error Message is Displayed” on page 129](#)

## Cleaning method

### From the computer

Explanations in this section use the Windows printer driver as an example.

Use **Epson Printer Utility 4** for Mac OS X.

[“Using Epson Printer Utility 4” on page 58](#)

- 1 Click **Head Cleaning** from the **Utility** tab in the printer driver's **Properties** (or **Print Settings**) screen.

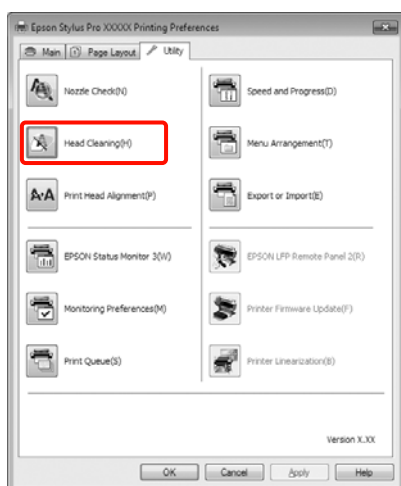

- 2 Click **Start**.  
Head cleaning starts and it takes about one to ten minutes.

- 3 Click **Print Nozzle Check Pattern**.

Confirm the nozzle check pattern.

If any segments are missing in the nozzle check pattern, click **Clean**.

### From the printer

Buttons that are used in the following settings

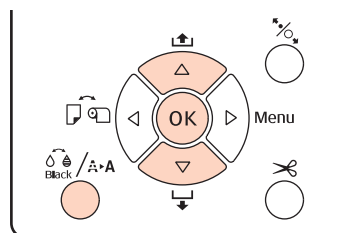

- 1 Press the **Back/⌫** button when the printer is in ready status, when no paper is loaded, or when printing is paused.

The Ink Menu is displayed.

- 2 Press the **▼/▲** buttons to select the type of cleaning, and then press the **OK** button.

- 3 You can perform cleaning by pressing the **OK** button when **Auto Cleaning** is selected. If you have selected **Manual Cleaning**, select the print head (color) to clean and press the **OK** button.

If you have selected **Manual Cleaning**, you also need to choose whether to perform normal cleaning or power cleaning. Cleaning begins once you have made your selection.

The **⏻** light starts flashing and head cleaning starts (it takes one to ten minutes.) However, when **Auto Nozzle Check** is set to **On** from the Menu, it may take ten minutes or longer. Cleaning is finished when the **⏻** light is on.

- 4 Print a nozzle check pattern, and check the result.

[“Nozzle Check” on page 113](#)

## Maintenance

## Correcting Print Misalignment (Print Head Alignment)

Because there is a small distance between the print head and paper, misalignment may occur due to humidity or temperature, the inertial force of the print head's movements, or by moving the print head bidirectionally. As a result, print results may appear grainy or out of focus. When this happens, perform Head Alignment to correct the print misalignment.

Although Head Alignment can be performed from the computer or the printer, the alignment procedures differ as explained below.

### ❑ From the printer

You can adjust automatically or manually after specifying the number of printed colors, and whether it should be printed bidirectionally or unidirectionally.

In auto adjustment, the sensor reads the adjustment pattern while it is printing, and automatically registers the optimum adjustment value to the printer.

In manual adjustment, you need to check the pattern and enter the optimum adjustment value for alignment.

There are four types of adjustment pattern.

**Uni-D** : Use all ink colors except Cyan to align the print head unidirectionally with reference to Cyan.

**Bi-D 5-Color** : Use Vivid Magenta, Black, Orange, Light Light Black, and Light Cyan ink colors to align the print head bidirectionally.

Either Matte Black or Photo Black ink is used for black based on the type of black ink currently selected in the printer.

**Bi-D 2-Color** : Use Cyan and Vivid Magenta ink colors to align the print head bidirectionally.

**Bi-D All** : Use all ink colors to align the print head bidirectionally.

### ❑ From the computer

Auto adjust with **Bi-D 5-Color**.

In most cases, head alignment can be performed successfully with just this operation. We normally recommend adjusting from the computer as this is the simplest method. However, if the results of the adjustment are not satisfactory, make adjustments from the printer.

#### **Tip:**

*Head Alignment is performed according to the width of the loaded paper. We recommend adjusting for the paper you are going to use.*

### From the computer

Explanations in this section use the Windows printer driver as an example.

Use **Epson Printer Utility 4** for Mac OS X.

 [“Using Epson Printer Utility 4” on page 58](#)

**1**

Make sure that the roll paper or a cut sheet of A4 size or larger is loaded in the printer.

Make sure you set the paper source and media type correctly according to the paper you use.

## Maintenance

- 2** Click **Print Head Alignment** from the **Utility** tab in the printer driver's **Properties** (or **Print Settings**) screen.

Follow the on-screen instructions to align the print head.



The sensor reads the adjustment pattern while it is printing, and automatically registers the optimum adjustment value to the printer.

### From the printer

To perform Head Alignment from the printer, make adjustments in the following order.

- (1) Perform **Paper Thickness**.
- (2) Select automatic or manual adjustment, and then perform the adjustment.

#### Tip:

- You cannot use the following types of paper when performing auto adjustment using the Head Alignment function.
  - Plain paper and thick paper
  - Paper smaller than A4 size
- When printing a Head Alignment pattern, it prints with the black ink currently selected in the printer, regardless of the type of paper loaded.

*When printing the pattern on glossy paper with Matte Black ink, try not to rub the printed surface as it is difficult to fixate Matte Black ink on glossy paper.*

Buttons that are used in the following settings

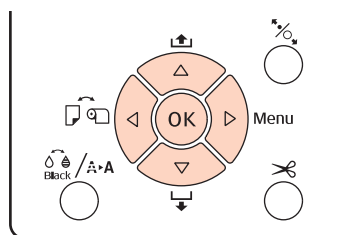

### Setting Paper Thickness

- 1** Make sure that the roll paper or a cut sheet of A4 size or larger is loaded in the printer.
- 2** Press the **▶** button to display the Menu.
- 3** Press the **▼/▲** buttons to select **Head Alignment**, and then press the **▶** button.
- 4** Press the **▼/▲** buttons to select **Paper Thickness**, and then press the **▶** button.
- 5** Set the **Paper Type** for Epson special media, and set the **Paper Thickness** for non-Epson media.

### Epson special media

- (1) Press the **▼/▲** buttons to select **Paper Type**, and then press the **▶** button.
- (2) Press the **▼/▲** buttons to select the paper type being used, and then press the **OK** button.

### Non-Epson media

- (1) Press the **▼/▲** buttons to select **Paper Thickness**, and then press the **▶** button.
- (2) Press the **▼/▲** buttons to select a paper thickness value between 4 to 60 mil (0.1 to 1.5 mm), and then press the **OK** button.

For the paper's thickness, check the paper's manual or with your local dealer.

- 6** Press the **⏏** button to close the Menu.

Refer to the instructions for details on how to perform both auto and manual adjustment.

## Maintenance

### Aligning the print head automatically

- 1 When the Menu is displayed, select **Head Alignment - Alignment**, and then press the ► button.
- 2 Press the ▼/▲ buttons to select **Auto**, and then press the ► button.
- 3 Press the ▼/▲ buttons to select the type of alignment pattern, and then press the ► button.  
  
If you have already performed Head Alignment from the computer, select **Uni-D**. If you are performing Head Alignment for the first time, select **Bi-D 5-Color**.
- 4 Press the OK button to print the pattern.  
  
The sensor reads the adjustment pattern while it is printing, and automatically registers the optimum adjustment value to the printer.

**Tip:**

*If the results of the **Bi-D 5-Color** adjustment are unsatisfactory, perform **Uni-D** adjustment. If the results of the **Uni-D** adjustment are unsatisfactory, perform **Bi-D All** adjustment.*

### Aligning the print head manually

In manual adjustment, adjust with **Uni-D** first and then with **Bi-D 2-Color**. If you want to make more precise adjustments, try **Bi-D All**.

- 1 When the Menu is displayed, select **Head Alignment - Alignment**, and then press the ► button.
- 2 Press the ▼/▲ buttons to select **Manual**, and then press the ► button.
- 3 Press the ▼/▲ buttons to select **Uni-D**, and then press the ► button.
- 4 Press the OK button to print the pattern.
- 5 Check the pattern and select the pattern number that has the least gaps.

- 6 If **Uni-D #1 C** is displayed on the control panel's screen, press the ▼/▲ buttons to select the pattern number you confirmed in step 5, and then press the OK button.
- 7 Set the number for #1 C to #4 VLM, and then press the OK button.  
  
#1 to #4 indicates the size of the ink dots.
- 8 Select **Bi-D 2-Color**, and then repeat steps 4 to 7.

**Tip:**

*When Head Alignment is complete, press the II button.*

*To make more precise adjustments, select **Bi-D All**, and repeat steps 4 to 7.*

# Replacing Consumables

## Replacing Ink Cartridges

If one of the installed ink cartridges is expended, printing cannot be performed. If an ink low warning is displayed, we recommend replacing the ink cartridge(s) as soon as possible.

If an ink cartridge runs out while printing, you can continue printing after replacing the ink cartridge. However, when replacing ink during a print job, you may see a difference in color depending on the drying conditions.

Supported ink cartridges  [“Options and Consumable Products”](#) on page 151

### How to replace

The following procedure uses Matte Black ink as an example. You can use the same procedure to replace all ink cartridges.

**Note:**

*Epson recommends the use of genuine Epson ink cartridges. Epson cannot guarantee the quality or reliability of non-genuine ink. The use of non-genuine ink may cause damage that is not covered by Epson's warranties, and under certain circumstances, may cause erratic printer behavior. Information about non-genuine ink levels may not be displayed, and use of non-genuine ink is recorded for possible use in service support.*

**1** Make sure the printer is on.

**2** Open the cartridge cover.

Press the groove in the cartridge cover to open the cover.

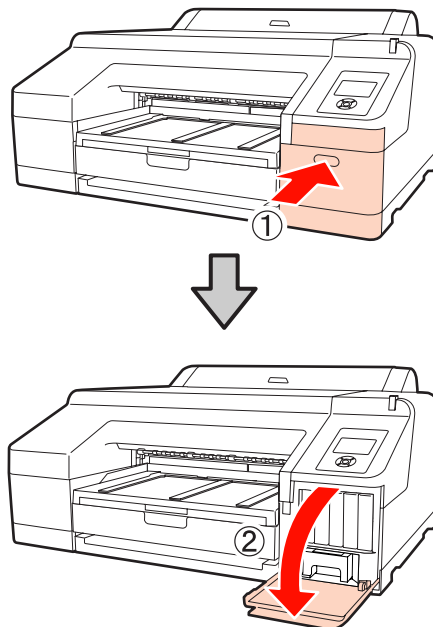

**3** Push the ink cartridge you want to replace into the printer.

You will hear a click and the ink cartridge pops out slightly.

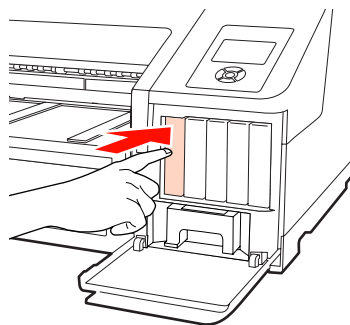

**4** Carefully pull the cartridge straight out of the slot.

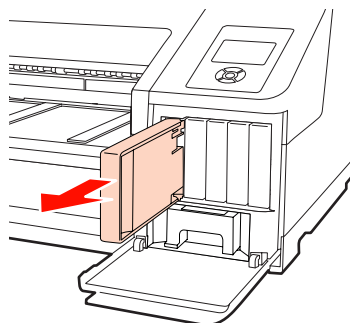



## Maintenance

**Note:**

Removed ink cartridges may have ink around the ink supply port, so be careful not to get any ink on the surrounding area when removing the cartridges.

**5**

Remove the ink cartridge from the bag. Shake the ink cartridge for 5 seconds 15 times horizontally in approximately 5 cm movements as shown in the illustration.

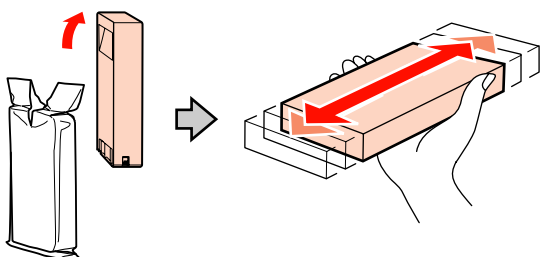

**Note:**

Do not touch the green IC chip on the ink cartridges. You may not be able to print properly.

**6**

Hold the ink cartridge with the arrow mark ▲ facing up, and then insert it into the slot as far as it will go until it clicks.

Match the ink cartridge color with the color label on the back of the cartridge cover.

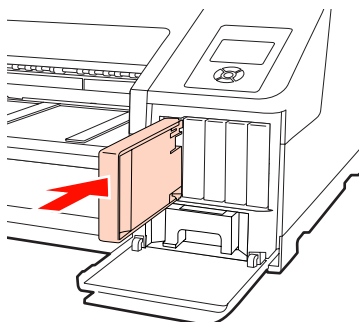

Repeat steps 3 to 6 to replace other ink cartridges.

**Note:**

Install all ink cartridges into each slot. You cannot print if any of the slots are empty.

**7**

Close the cartridge cover.

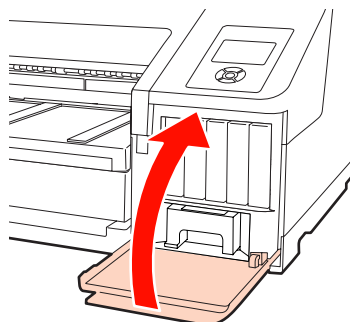

## Replacing Maintenance Box 1 and 2

If the message **Replace Maint Box** or **Not Enough Empty Space** is displayed, replace the specified Maintenance Box.

Supported Maintenance Boxes

 [“Options and Consumable Products” on page 151](#)

**Note:**

Do not attempt to re-use maintenance box 1 or 2 that has been removed and left out in the open for a long period of time. The ink on the inside will be dry and hard and will be unable to absorb enough ink.

## Replacing Maintenance Box 1

The on-screen message reads Maintenance Box 1, however the product name for this consumable is Maintenance Box.

**Note:**

Do not replace Maintenance Box 1 while printing. Waste ink may leak.

## Maintenance

- 1** Open the right-hand side cartridge cover.

Press the groove in the cartridge cover to open the cover.

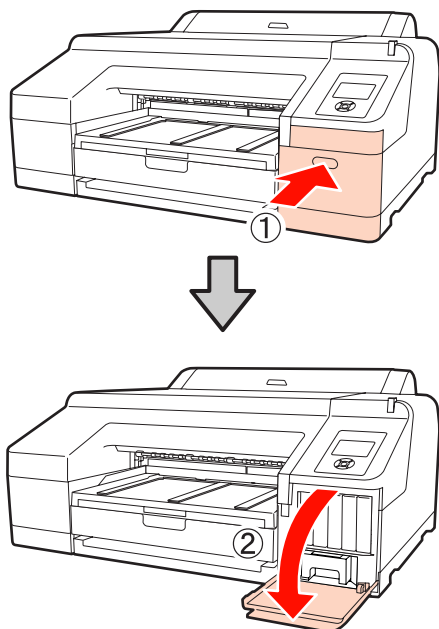

- 2** Pull Maintenance Box 1 out.

Lifting Maintenance Box 1 up releases the lock, and you can simply pull it straight out.

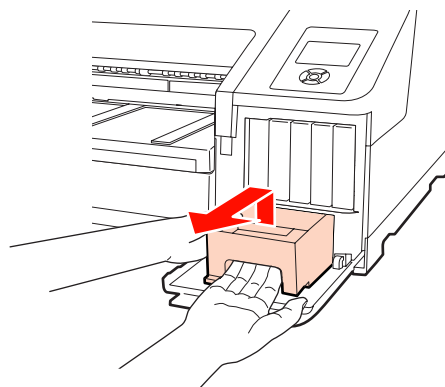

- 3** Place the used Maintenance Box 1 in the clear bag included with your new Maintenance Box 1, and make sure that the zipper is closed tight.

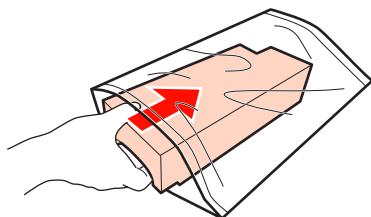

- 4** Insert the new Maintenance Box 1.

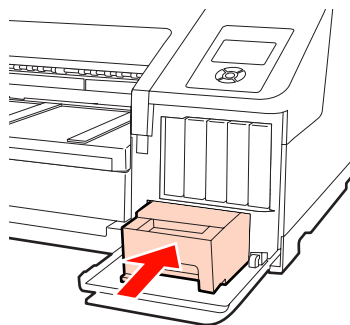
**Note:**

Pay attention to the following since the printer may not operate or print correctly otherwise.

- Do not touch the green IC chip on the side of Maintenance Box 1.
- Do not remove the film from the top of Maintenance Box 1.

- 5** Close the cartridge cover.

## Replacing Maintenance Box 2

The instructions for replacing Maintenance Box 2 (Maintenance Box for borderless printing) are as follows.

The on-screen message reads Maintenance Box 2, however the product name for this consumable is Borderless Maintenance Box.

**Note:**

Do not replace Maintenance Box 2 while printing. Printing stops if the lock on Maintenance Box 2 is released. If stopped in the middle of printing, colors may vary and/or print quality may decline once printing is resumed.

## Maintenance

- 1** Remove the output tray.

Lift the edge of the output tray slightly to remove it. Also remove the optional SpectroProofer if installed.

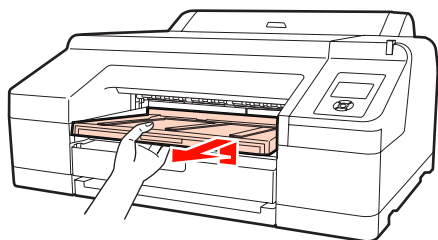

- 2** Release the Maintenance Box 2 lock.

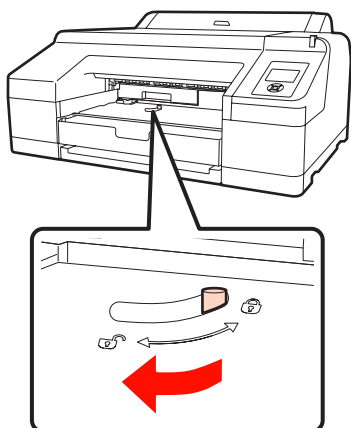

- 3** Pull Maintenance Box 2 out carefully so that it does not tilt.

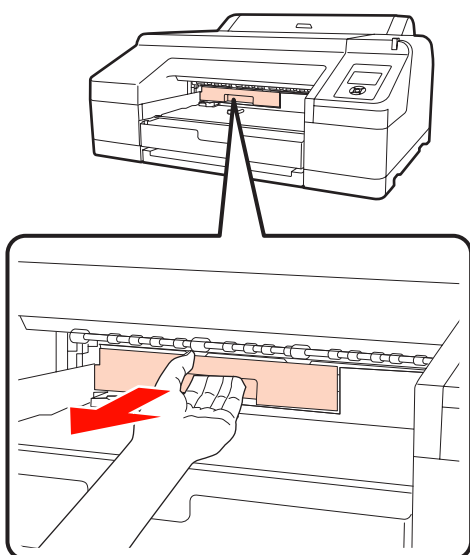

**! Caution:** If ink should spill out onto your skin or into your eyes, wash the affected area with water immediately.

- 4** Place the used Maintenance Box 2 in the clear bag included with your new Maintenance Box 2, and make sure that the zipper is closed tight.

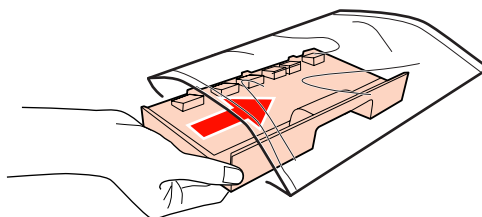

**Note:** Do not tilt Maintenance Box 2 until it is completely in the clear bag and the zipper is closed. The waste ink may leak and soil the surrounding area.

- 5** Insert the new Maintenance Box 2.

Push it in firmly.

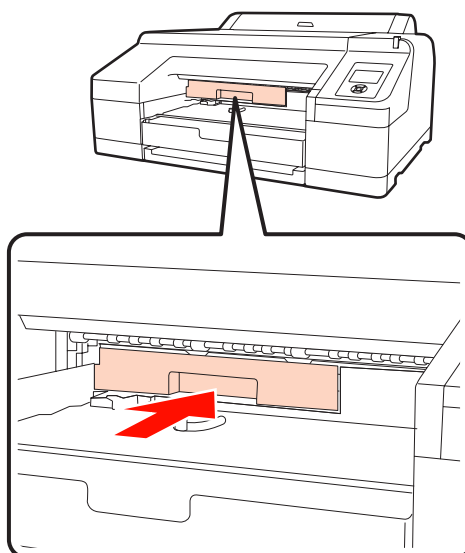

**Note:** Do not touch the green IC chip on the side of Maintenance Box 2. Doing so may prevent normal operation and printing.

## Maintenance

- 6** Set the lock.

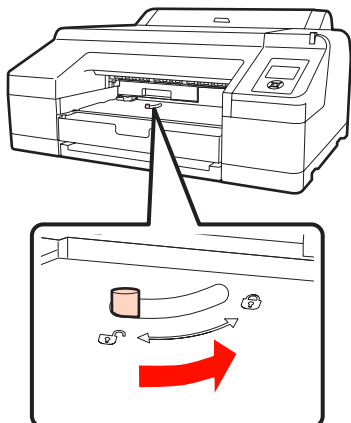

- 7** Attach the output tray.

Return optional SpectroProofer if it was installed.

## Replacing the Cutter

Replace the cutter when it is not cutting paper cleanly.

Supported cutter

 [“Options and Consumable Products” on page 151](#)

Use a cross-head screwdriver to replace the cutter. Make sure you have a cross-head screwdriver with you before replacing the cutter.

**Note:**

*Take care not to damage the cutter blade. Dropping it or knocking it against hard objects may chip the blade.*

- 1** Turn off the printer.

If paper is loaded, remove it from the printer. Remove when the optional SpectroProofer is installed.  [SpectroProofer Mounter 17" User's Guide](#)

- 2** Open the cartridge covers on the left and right.

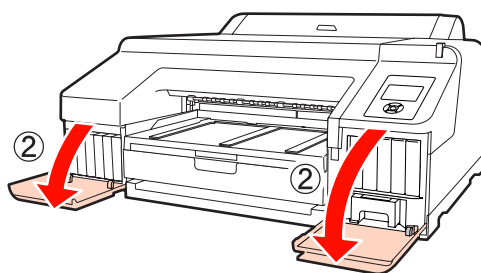
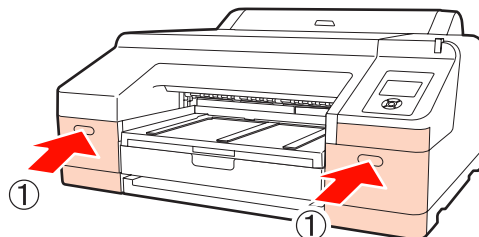

- 3** Open the printer cover.

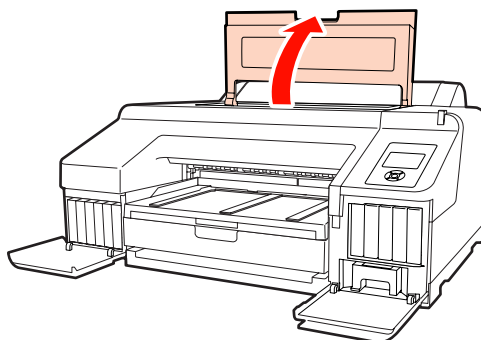

- 4** Remove the front cover.

Use a cross-head screwdriver and remove the four screws holding the front cover in place. Remove the front cover.

Maintenance

Remove when the optional SpectroProofer is installed.

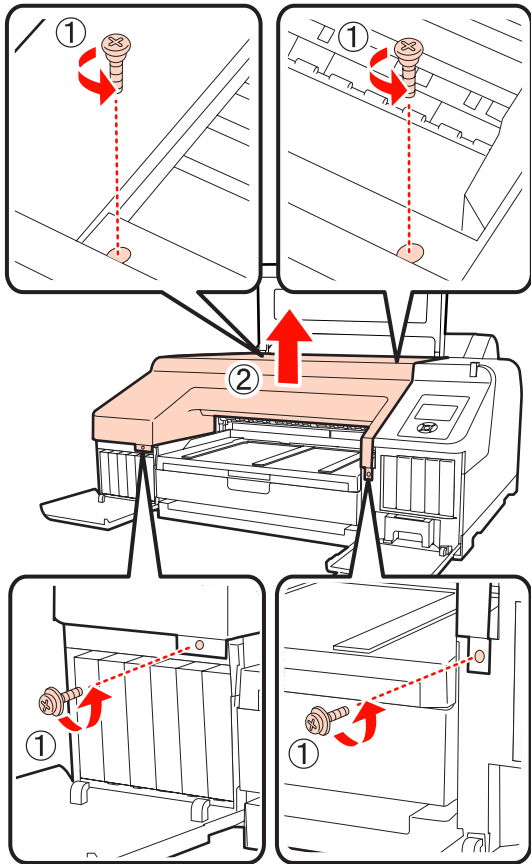

**5** Open the cutter cover.

Pull the cover towards you while holding down the lock as shown in the figure to open the cover.

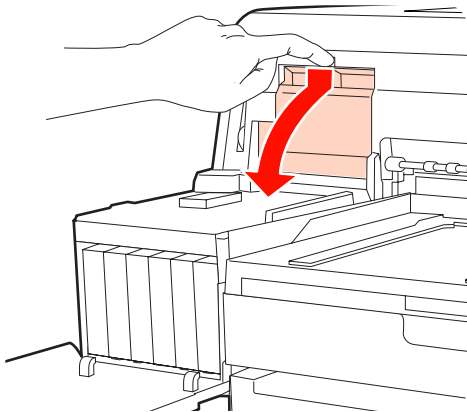

**6** Remove the old cutter from the printer.

Loosen the screw holding the cutter in place using a cross-head screwdriver and pull the cutter straight out.

**Caution:** Do not store the cutter within the reach of children. The cutter's blade could cause an injury. Pay careful attention when replacing the cutter.

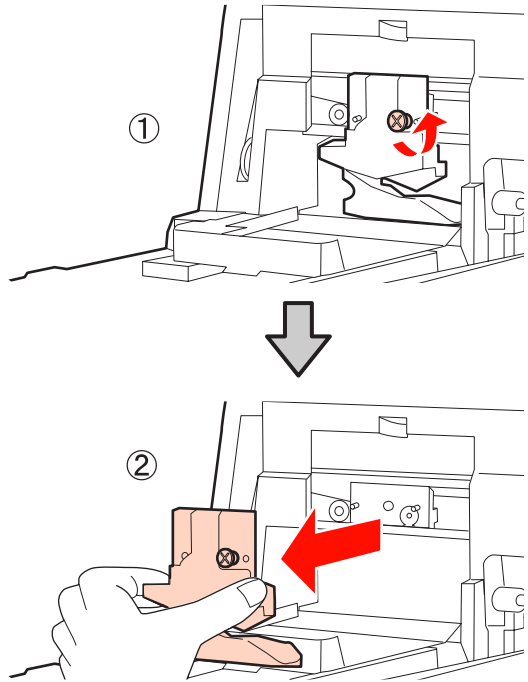

**7** Install the new cutter.

Insert the cutter so that the pin on the printer matches up with the hole on the cutter. Use a cross-head screwdriver to tighten down the screw to hold the cutter in place.

**Note:** Screw up the cutter firmly, otherwise the cut position may be slightly shifted or skewed.

Maintenance

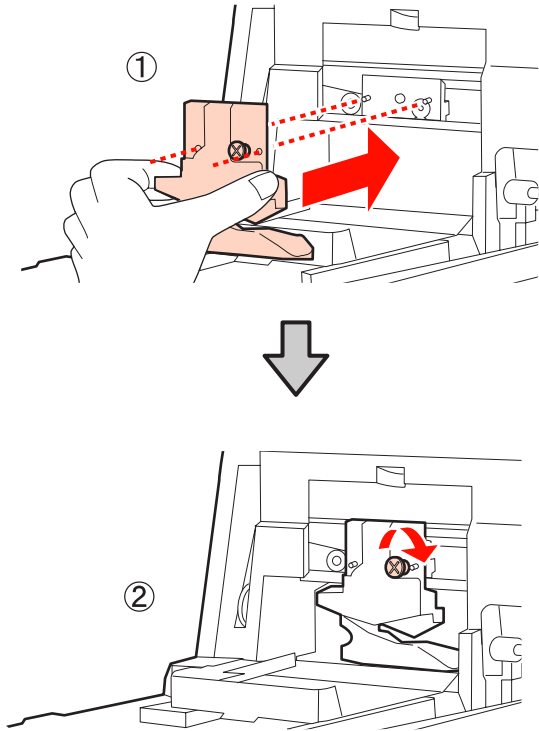

**8** Close the cover.

Push in the cover until you hear the upper portion click into place.

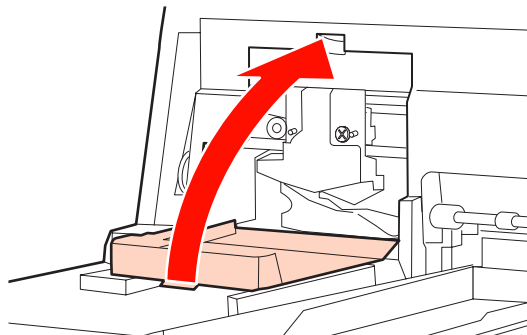

**9** Return the front cover.

Re-insert the four screws that hold the cover in place and use a cross-head screwdriver to tighten them down. The shape of the screws differ for the top and the front. Use the screws that come with a washer for the front section (the cartridge cover section).

If you are using the optional SpectroProofer, install the SpectroProofer into place without returning the front cover.

**Note:**  
If the front cover is not properly in place, an error occurs and the printer does not respond.

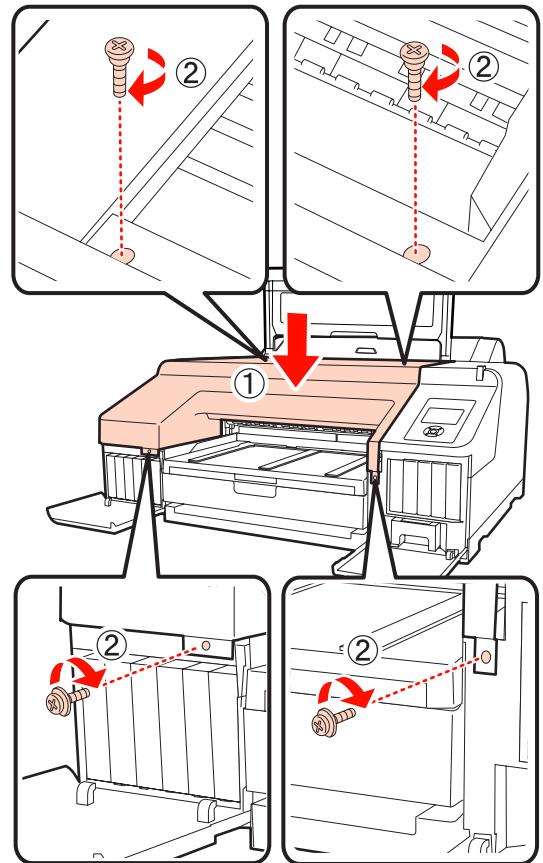

**10** Close the printer cover and the left and right cartridge covers.

## Maintenance

# Cleaning the Printer

To keep your printer in optimum operating condition, clean it regularly (about once a month).

---

## Cleaning the outside

- 1 Remove any paper from the printer.
- 2 Make sure the printer is turned off and the screen has turned off, and then unplug the power cable from the electrical outlet.
- 3 Use a soft, clean cloth to carefully remove any dust or dirt.

If there is a serious dirt problem, clean it using a soft, clean cloth dampened with a mild detergent. Then wipe off with a dry, soft cloth.

**Note:**

*Never use benzene, thinners, or alcohol to clean the printer. They could cause discoloration and deformities.*

---

## Cleaning the inside

Perform one of the following cleaning operations if print outs are smudged or soiled.

- Cleaning the roller
 

Perform if roll paper, rear feed, or front feed print outs are smudged or soiled.
- Cleaning the paper cassette printing path
 

Perform if print outs from the paper cassette are soiled or paper particles are on the print out preventing ink from being applied in those areas.

## Cleaning the roller

Follow the steps below to clean the roller by feeding plain paper.

- 1 Turn on the printer, and load A2 or 17 inch wide roll paper.

 [“Loading and Removing the Roll Paper” on page 26](#)

- 2 Press the ▼ button.

Paper is fed as long as the button is pressed. If the paper is not soiled, cleaning is complete.

Cut the paper after cleaning is done.

 [“Manual cut method” on page 32](#)

## Cleaning the paper cassette printing path

Follow the steps below to clean any soiled areas by outputting plain paper.

- 1 Load A2 or 17 inch wide cut sheets in the paper cassette.

 [“Loading the Paper Cassette” on page 35](#)

- 2 Check that the printer is turned on, and check that cut sheets is selected as the paper type.

- 3 Press the ▼ button.

Paper is ejected from the paper cassette.

Repeat step 3 until the paper is not soiled with ink.

## Cleaning inside

- 1 Make sure the printer is turned off and the screen has turned off, and then unplug the power cable from the electrical outlet.

- 2 Leave the printer for a minute.

## Maintenance

- 3** Open the printer cover and use a soft, clean cloth to carefully clean away any dust or dirt inside the printer.

Wipe the pink part shown in the following illustration. To avoid spreading the dirt, wipe from the inside to the outside. If there is a serious dirt problem, clean it using a soft, clean cloth dampened with a mild detergent. Then, wipe the inside of the printer with a dry, soft cloth.

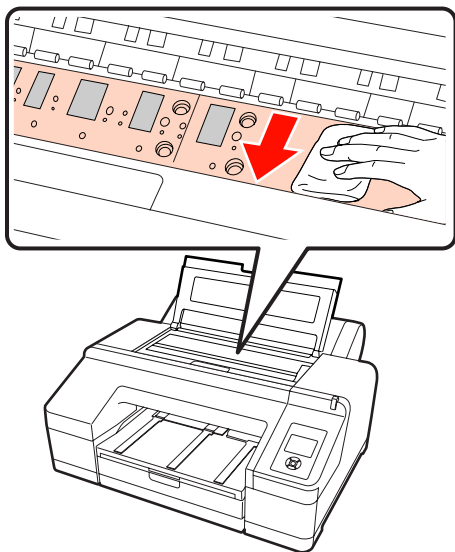
**Note:**

- ❑ When cleaning, do not touch the roller and the ink absorption (gray parts) in the illustration above; otherwise, prints may be soiled.
- ❑ Be careful not to touch the ink tubes inside the printer, otherwise, the printer may be damaged.

- 4** If any paper particles (that looks like white powder) accumulates on the platen, use something like a cocktail stick to push it in.

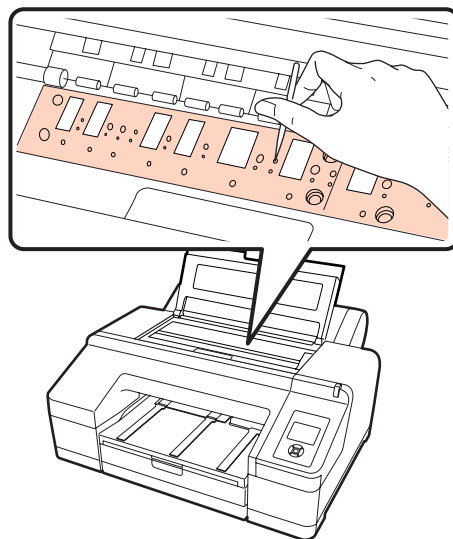

- 5** When you have finished cleaning, close the printer cover.

















# Problem Solver









## When an Error Message is Displayed

If an error should occur with the printer (it is not working properly), the alert lamp and/or control panel light will light up and a message is displayed on the screen informing you of the problem.

The messages displayed are described in the following section. If you encounter an error message, refer to the solutions listed here and perform the necessary steps to fix the problem.

Error messages	What to do
Auto Cleaning This feature is not available now. Print the check pattern in the nozzle check menu.	Press the OK button to remove the message and then execute <b>Print Check Pattern</b> from the Ink Menu.  <a href="#">"Nozzle Check" on page 113</a>
Auto Nozzle Check This feature is not available now. Print the check pattern in the nozzle check menu.	Press the OK button to remove the message and then execute <b>Print Check Pattern</b> from the Ink Menu.  <a href="#">"Nozzle Check" on page 113</a>
Black Ink Error Black ink does not match print job.  To cancel printing, press  button. To change black ink to print, press  button.	The type of black ink setting on the printer and in the printer driver is not the same. Press the  button to switch to the type of black ink specified in the printer driver and continue printing. It takes approximately 2 to 3 minutes to switch black ink types (from ink replacement until ink charging is complete). Also, approximately 2 to 4 ml of the black ink being changed to is consumed. Do not switch the black ink unless necessary.
Borderless Error Load a supported paper size or load paper correctly.	Check the following points. <ul style="list-style-type: none"> <li><input type="checkbox"/> Press the  button to perform <b>Job Cancel</b>, and then eject the paper. Load the correct size of paper.   <a href="#">"Loading Roll Paper" on page 27</a>   <a href="#">"Loading Cut Sheets" on page 34</a>   <a href="#">"Supported Media Sizes for Borderless Printing" on page 69</a> </li> <li><input type="checkbox"/> If the paper is wavy or slack, the printer cannot recognize the paper size correctly. Flatten the paper before loading it in the printer, or use new paper.   <a href="#">"Loading Cut Sheets" on page 34</a> </li> <li><input type="checkbox"/> Load paper in the correct position.   <a href="#">"Loading Roll Paper" on page 27</a>   <a href="#">"Loading Cut Sheets" on page 34</a> </li> <li><input type="checkbox"/> If <b>Paper Size Check</b> is set to <b>Off</b> from the Menu, try setting it to <b>On</b>.   <a href="#">"Printer Setup menu" on page 103</a> </li> </ul>
Cartridge Cover Open Close left cartridge cover.	Close the cartridge cover on the left.  <a href="#">"Replacing Ink Cartridges" on page 120</a>

## Problem Solver

Error messages	What to do
Cartridge Cover Open Close right and left cartridge covers.	Close the left and right cartridge covers.  <a href="#">"Replacing Ink Cartridges" on page 120</a>
Cartridge Cover Open Close right cartridge cover.	Close the cartridge cover on the right.  <a href="#">"Replacing Ink Cartridges" on page 120</a>
Cleaning Error Automatic head cleaning failed. Retry? Yes No	Clogged nozzles could not be cleared even after cleaning. Select <b>Yes</b> to clean again.  <a href="#">"Cleaning the print head" on page 115</a>  If the cleaning does not start, cancel printing from the computer, turn off the printer, wait for a while and then turn it on again.  If you select <b>No</b> , cleaning is canceled and it returns to a ready status.
Cleaning Error Not enough empty space in maint box 1. Continue cleaning? Yes (recommended) No	If you select <b>Yes</b> , the Maintenance Box 1 replacement message is displayed. Replace the Maintenance Box with a new one to continue cleaning.  <a href="#">"Replacing Maintenance Box 1" on page 121</a>  If you select <b>No</b> , cleaning is canceled and it returns to a ready status.
Cleaning Error Not enough ink Continue cleaning? Yes (Recommended) No	If you select <b>Yes</b> , the ink cartridge replacement message is displayed. Replace the ink cartridge with a new one to continue cleaning.  <a href="#">"Replacing Ink Cartridges" on page 120</a>  If you select <b>No</b> , cleaning is canceled and it returns to a ready status.
Clogged nozzles detected. Cleaning recommended.	Perform head cleaning to remove any clogs. This message continues to be displayed until the clogged nozzles have been cleared, but it is removed when a check pattern is printed. Printing is possible while the message is displayed.  <a href="#">"Adjusting the Print Head" on page 113</a>
Command Error Check driver settings.	Press the  button and select <b>Job Cancel</b> to cancel printing. Then make sure that you have installed the correct printer driver for the printer.
Cutter unit nearing end of service life. Recommend replacing the cutter unit.	Paper cutter may be blunt. Replace the cutter.  <a href="#">"Replacing the Cutter" on page 124</a>
F/W Install Error Update failed. Restart the printer.	Turn the printer off, wait for a few minutes, and then turn on the printer again. Then try updating the firmware again using EPSON LFP Remote Panel 2. If this message appears on the screen again, contact your dealer or Epson Support.
Ink Cartridge Alert Non-genuine cartridge! Quality of non-genuine ink may vary.  Non-genuine cartridge may not perform at optimum. Continue? Decline Accept	Select <b>Decline</b> to replace the ink cartridge with a genuine Epson ink cartridge. Selecting <b>Accept</b> may void EPSON's warranty.  <a href="#">"Options and Consumable Products" on page 151</a>  <a href="#">"Replacing Ink Cartridges" on page 120</a>

## Problem Solver

Error messages	What to do
Ink Cartridge Alert Please use genuine Epson ink cartridges.	Replace the ink cartridge with a genuine Epson ink cartridge that can be used with this printer. <a href="#">☞ "Options and Consumable Products" on page 151</a> <a href="#">☞ "Replacing Ink Cartridges" on page 120</a>
Ink Cartridge Alert Replace ink cartridge(s).	<ul style="list-style-type: none"> <li><input type="checkbox"/> Remove the ink cartridge and reinstall it. If this message is displayed after reinstalling the ink cartridge, replace it with a new one. (Do not reinstall the ink cartridge that caused the error.) <a href="#">☞ "Replacing Ink Cartridges" on page 120</a></li> <li><input type="checkbox"/> Condensation may occur in the ink cartridge. Leave it at room temperature for at least four hours before installing the ink cartridge. <a href="#">☞ "Notes on handling ink cartridges" on page 20</a></li> </ul>
Ink Cartridge Error Please install the correct ink cartridge.	Remove the ink cartridge, and install an ink cartridge that can be used with this printer. <a href="#">☞ "Options and Consumable Products" on page 151</a> <a href="#">☞ "Replacing Ink Cartridges" on page 120</a>
Ink Cartridge Expended Replace ink cartridge.	Replace the ink cartridge with a new one. <a href="#">☞ "Replacing Ink Cartridges" on page 120</a>
Ink Low	Prepare a new ink cartridge for replacement. <a href="#">☞ "Replacing Ink Cartridges" on page 120</a>
Ink Too Low To Clean Replace ink cartridge.  The cartridge being used can be installed again for printing.	The message displayed when <b>Yes</b> is selected due to a Cleaning Error or Nozzle Clog Detected error. Replace the ink cartridge with a new one. <a href="#">☞ "Replacing Ink Cartridges" on page 120</a>
Maint Box 2 Unlocked Lock lever for maintenance box 2.	Lock Maintenance Box 2. The on-screen message reads Maintenance Box 2, however the product name for this consumable is Borderless Maintenance Box. <a href="#">☞ "Replacing Maintenance Box 2" on page 122</a>
Maint box near end of service life.	Check to see if free space is running low in Maintenance Box 1 or Maintenance Box 2 by looking at the control panel's screen. After confirming, replace the maintenance box running low on free space with a new one. <a href="#">☞ "Replacing Maintenance Box 1 and 2" on page 121</a>
Maintenance Box 1 Error Replace maintenance box 1.	Set Maintenance Box 1 again correctly. If the same error occurs, replace Maintenance Box 1 with a new one. The on-screen message reads Maintenance Box 1, however the product name for this consumable is Maintenance Box. <a href="#">☞ "Replacing Maintenance Box 1" on page 121</a>
Maintenance Box 2 Error Replace maintenance box 2.	Set Maintenance Box 2 again correctly. If the same error occurs, replace Maintenance Box 2 with a new one. The on-screen message reads Maintenance Box 2, however the product name for this consumable is Borderless Maintenance Box. <a href="#">☞ "Replacing Maintenance Box 2" on page 122</a>

## Problem Solver

Error messages	What to do
No Front Cover Attach front cover then restart printer.	Turn off the printer, then install the front cover. Reinstall the device correctly and then turn on the printer. Installing the front cover  <a href="#">"Replacing the Cutter" on page 124</a>
No Ink Cartridges Install ink cartridge(s).	Install ink cartridges.  <a href="#">"Replacing Ink Cartridges" on page 120</a>
No Maintenance Box 1 Install maintenance box 1.	Install Maintenance Box 1 correctly.  <a href="#">"Replacing Maintenance Box 1" on page 121</a>
No Maintenance Box 2 Install maintenance box 2.	Install Maintenance Box 2 correctly.  <a href="#">"Replacing Maintenance Box 2" on page 122</a>
No Paper Cassette Install paper cassette.	Install paper cassette.  <a href="#">"Loading the Paper Cassette" on page 35</a>
No Rear Unit Install the rear unit.	Install the rear unit. For details on how to install the rear unit, refer to the "Cut sheets from the paper cassette have jammed while printing" section that follows.  <a href="#">"Feeding or ejecting problems" on page 146</a>
Not Enough Empty Space Replace the maintenance box 1.	Replace Maintenance Box 1 with a new one. The on-screen message reads Maintenance Box 1, however the product name for this consumable is Maintenance Box.  <a href="#">"Replacing Maintenance Box 1" on page 121</a>
Nozzle Clog Detected Not enough empty space in maint box 1. Continue cleaning? Yes (recommended) No	If you select <b>Yes</b> , the Maintenance Box 1 replacement message is displayed. Replace the Maintenance Box with a new one to continue cleaning.  <a href="#">"Replacing Maintenance Box 1" on page 121</a> If you select <b>No</b> , cleaning is canceled and it returns to a ready status.
Nozzle Clog Detected Not enough ink. Continue cleaning? Yes (Recommended) No	If you select <b>Yes</b> , the ink cartridge replacement message is displayed. Replace the ink cartridge with a new one to continue cleaning.  <a href="#">"Replacing Ink Cartridges" on page 120</a> If you select <b>No</b> , cleaning is canceled and it returns to a ready status.
Paper Cut Error Remove uncut paper.	Roll paper is not cut correctly. Press the  button to release the paper presser and then remove the uncut paper.  <a href="#">"Feeding or ejecting problems" on page 146</a> Replace the cutter if the blade is blunt.  <a href="#">"Replacing the Cutter" on page 124</a>
Paper Eject Error Press the  button.	Press the  button to rewind the roll paper.  <a href="#">"Removing the roll paper" on page 32</a>
Paper Jam Remove paper from printer.	Press the  button to release the paper presser, and then remove the paper.





## Problem Solver

Error messages	What to do
<p>Paper Jam Remove paper from printer. Power off and then on.</p>	<p>Refer to the "Roll paper jam", "Cut sheets from the paper cassette have jammed while printing", or "Cut sheets from the front/rear manual feeder have jammed" sections on the reference page that follows and remove the jammed paper.</p> <p><a href="#">☞ "Feeding or ejecting problems" on page 146</a></p>
<p>Paper Load Error Press the ▲ button and remove the jammed paper.</p>	<p>Refer to the "Cut sheets from the front/rear manual feeder have jammed" section in the chart on the following reference page and remove the jammed paper.</p> <p><a href="#">☞ "Feeding or ejecting problems" on page 146</a></p>
<p>Paper Load Error Press the ⌘ button and remove the jammed paper.</p>	<p>Refer to the "Cut sheets from the front/rear manual feeder have jammed" section in the chart on the following reference page and remove the jammed paper.</p> <p><a href="#">☞ "Feeding or ejecting problems" on page 146</a></p>
<p>Paper Load Error Press the ⌘ button and reset roll paper.</p>	<p>Press the ⌘ button to rewind the roll paper, then load it into the printer.</p> <p><a href="#">☞ "Loading roll paper" on page 29</a></p>
<p>Paper Load Error Remove paper cassette to fix paper jam.</p>	<p>Refer to the "Cut sheets from the paper cassette have jammed while printing" section in the chart on the following reference page and remove the jammed paper.</p> <p><a href="#">☞ "Feeding or ejecting problems" on page 146</a></p>
<p>Paper Load Error Remove paper from rear manual feeder and press the ▼ button.</p>	<p>Refer to the "Cut sheets from the front/rear manual feeder have jammed" section in the chart on the following reference page and remove the jammed paper.</p> <p><a href="#">☞ "Feeding or ejecting problems" on page 146</a></p>
<p>Paper Load Error Remove the rear unit to fix paper jam.</p>	<p>Refer to the "Cut sheets from the paper cassette have jammed while printing" section in the chart on the following reference page and remove the jammed paper.</p> <p><a href="#">☞ "Feeding or ejecting problems" on page 146</a></p>
<p>Paper Low</p>	<p>Prepare a new roll paper for replacement.</p> <p><a href="#">☞ "Loading and Removing the Roll Paper" on page 26</a></p>
<p>Paper Out For paper less than 0.8 mm thickness, insert from rear manual feeder. For thicker paper, press ⌘ button then insert from front manual feeder.</p>	<p>Load the paper into the rear manual feeder or front manual feeder depending on the thickness of the paper.</p> <p><a href="#">☞ "Loading Manually from the Rear" on page 39</a></p> <p><a href="#">☞ "Loading and Ejecting Thick Paper" on page 40</a></p>
<p>Paper Out Load paper in paper cassette.</p>	<p>Confirm that no paper is being printed, then remove the paper cassette and load the paper.</p> <p><a href="#">☞ "Loading the Paper Cassette" on page 35</a></p>
<p>Paper Out Press the ⌘ button.</p>	<p>Press the ⌘ button then load the roll paper.</p> <p><a href="#">☞ "Loading Roll Paper" on page 27</a></p> <p>If you run out of paper while printing, the remaining data is printed once you load new paper. If you want to print from the beginning on the new paper instead of continuing from where the job was paused, press the II button and select <b>Job Cancel</b>. After that, load the new paper and perform the print operation again.</p>

## Problem Solver

Error messages	What to do
<p>Paper Sensor Error Loaded paper or print out has a problem. Refer to manual for details.</p>	<p>If this error is displayed when performing automatic head alignment check the following items.</p> <ul style="list-style-type: none"> <li><input type="checkbox"/> Did you load paper that is not supported for automatic head alignment? Automatic head alignment cannot be performed with plain paper or thick paper.</li> <li><input type="checkbox"/> Did you load paper that is smaller than A4 size? Load paper that is of A4 size or larger.</li> <li><input type="checkbox"/> Are some nozzles clogged? Perform head cleaning. <a href="#">↗ "Cleaning method" on page 116</a></li> </ul> <p>If this error is displayed at any other time besides when performing automatic head alignment, make sure that the paper loaded is supported by the printer. The printer cannot print correctly on paper such as tracing paper or transparency.</p>
<p>Paper Setting Error Check the paper source in your driver settings or reload paper correctly.</p>	<p>The paper feed setting in the printer driver and under Paper Type do not match. Check the loaded paper, the Paper Type settings, and the printer driver settings.</p>
<p>Paper Setting Error Roll paper is loaded. Remove it and change paper source to roll paper.</p>	<p>Pull out the roll paper and select roll paper from the Paper Type menu. <a href="#">↗ "Loading roll paper" on page 29</a></p>
<p>Paper Setting Error This paper can not be loaded from paper cassette. Insert paper less than 0.8 mm thickness from rear manual feeder.</p>	<p>Paper that cannot be printed from the paper cassette has been loaded in the paper cassette. Press the <b>II</b> button and select <b>Job Cancel</b>, then remove the paper from the paper cassette. Print by feeding the paper into the front manual feeder or rear manual feeder depending on the thickness of the paper.</p> <p><a href="#">↗ "Epson Special Media Table" on page 153</a> <a href="#">↗ "Loading Cut Sheets" on page 34</a></p>
<p>Paper Size Error Load correct paper size.</p>	<p>The loaded paper width is not supported. Press the <b>⌘</b> button to release the paper presser, and then remove the paper.</p> <p>Check the following conditions and load paper with an appropriate width.</p> <ul style="list-style-type: none"> <li><input type="checkbox"/> The smallest paper width that can be used in the printer is 8 inches.</li> <li><input type="checkbox"/> Make sure that A4 size or larger paper is loaded when performing head alignment.</li> </ul> <p>If an error message is displayed even though paper with an appropriate width is loaded, you may be able to print by setting <b>Paper Size Check</b> to <b>Off</b> from the Menu. <a href="#">↗ "Printer Setup menu" on page 103</a></p>
<p>Paper Skew Load paper correctly.</p>	<p>The paper is not loaded straight. Press the <b>⌘</b> button to release the paper presser, and then load the paper correctly.</p> <p><a href="#">↗ "Loading Roll Paper" on page 27</a> <a href="#">↗ "Loading Cut Sheets" on page 34</a></p>
<p>Paper Source Error Cut sheet is loaded. Remove it and change paper source to roll paper.</p>	<p>Press the OK button to clear the message, and then remove the cut sheets from the printer and change the source in the Paper Type menu.</p>

## Problem Solver

Error messages	What to do
<p>Paper Source Error Roll paper is loaded. Remove it and change paper source to cut sheet.</p>	<p>Press the OK button to clear the message, and then remove the roll paper from the printer and change the source in the Paper Type menu. When <b>Auto Roll Feeding</b> is set to <b>Off</b> from the Menu, you cannot change the paper type when roll paper is fed.</p> <p> <a href="#">"Removing the roll paper" on page 32</a></p>
<p>Printer Cover Open Please close the cover.</p>	<p>Close the printer cover.</p>
<p>Replace Maint Box 1 At the end of service life. Replace maint box 1.</p>	<p>Replace Maintenance Box 1 with a new one.</p> <p>The on-screen message reads Maintenance Box 1, however the product name for this consumable is Maintenance Box.</p> <p> <a href="#">"Replacing Maintenance Box 1" on page 121</a></p>
<p>Replace Maint Box 2 To continue borderless printing, replace maint box 2.</p>	<p>To perform borderless printing you must replace Maintenance Box 2.</p> <p>The on-screen message reads Maintenance Box 2, however the product name for this consumable is Borderless Maintenance Box.</p> <p> <a href="#">"Replacing Maintenance Box 2" on page 122</a></p>
<p>SpectroProofer Error Connect cable of SpectroProofer then restart printer.</p>	<p>Turn off the printer and connect the SpectroProofer mounter's printer connector cable. Turn on the printer once you are sure the printer connector cable is connected properly.</p> <p> SpectroProofer Mounter 17" <i>Setup Guide</i> (Sheet)</p>
<p>SpectroProofer Error Refer to the manual and connect the ILS20EP to SpectroProofer. Turn the printer power off, and then on again.</p>	<p>Turn off the printer, and then remove the color measurement device from the SpectroProofer mounter. Reinstall it correctly and then turn on the printer.</p> <p> SpectroProofer Mounter 17" <i>Setup Guide</i> (Sheet)</p>

## Problem Solver

Error messages	What to do
<p>SpectroProofer Error Refer to the manual to find out how to solve the problem. XX</p> <p>(The error number is displayed instead of XX)</p>	<p>Check the error number and handle the problem as follows.</p> <ul style="list-style-type: none"> <li>❑ If error number 01 is displayed           <p>Turn off the printer, and then remove the SpectroProofer mounter. Turn on the printer when the cover is correctly installed.</p> <p><a href="#">↗ SpectroProofer Mounter 17" User's Guide (PDF)</a>  <a href="#">↗ SpectroProofer Mounter 17" Setup Guide (Sheet)</a></p> <p>If this message appears on the screen again, contact your dealer or Epson Support.</p> </li> <li>❑ If error number 02 is displayed           <p>Turn off the printer, and then remove the SpectroProofer mounter. Remove the SpectroProofer paper guide unit, and then reinstall it correctly. Reinstall the SpectroProofer mounter correctly and then turn on the printer.</p> <p><a href="#">↗ SpectroProofer Mounter 17" User's Guide (PDF)</a>  <a href="#">↗ SpectroProofer Mounter 17" Setup Guide (Sheet)</a></p> <p>If this message appears on the screen again, contact your dealer or Epson Support.</p> </li> <li>❑ Error number 13 or 15 is displayed           <p>Turn off the printer, and then remove the SpectroProofer mounter. Remove any foreign objects and packing materials around the backing of the printer. Reinstall the backing correctly. Reinstall the SpectroProofer mounter correctly and then turn on the printer.</p> <p><a href="#">↗ SpectroProofer Mounter 17" User's Guide (PDF)</a>  <a href="#">↗ SpectroProofer Mounter 17" Setup Guide (Sheet)</a></p> <p>Check there are no problems with the media type or the environment.</p> <p><a href="#">↗ SpectroProofer Mounter 17" User's Guide (PDF)</a></p> <p>If this message appears on the screen again, contact your dealer or Epson Support.</p> </li> <li>❑ If error number 08 is displayed           <p>Turn off the printer, and then remove the ILS20EP and the white calibration tile from the SpectroProofer mounter. Check that the number on the label mentioned on the ILS20EP and the white calibration tile are the same, otherwise, try again with a combination of the same number. If the lens in the ILS20EP or the white calibration tile is soiled, clean it. Return the parts correctly and then turn on the printer.</p> <p><a href="#">↗ SpectroProofer Mounter 17" User's Guide (PDF)</a></p> <p>If this message appears on the screen again, contact your dealer or Epson Support.</p> </li> <li>❑ If any other code appears on the screen, note the code and contact your dealer or Epson Support.</li> </ul>
<p>Wrong Support Position Lower the paper eject support.</p>	<p>The paper eject support is raised. Lower the paper eject support.</p>
<p>Wrong Support Position Raise the paper eject support.</p>	<p>The paper eject support is lowered. Raise the paper eject support.</p>



## Problem Solver



### When a Maintenance Call/Service Call Occurs

Error messages	What to do
<p>Call For Service Code XXXX Power off and then on. If this doesn't work, note the code and call for service.</p>	<p>A call for service occurs when:</p> <ul style="list-style-type: none"> <li><input type="checkbox"/> The power cable is not connected securely</li> <li><input type="checkbox"/> An error that cannot be cleared occurs</li> </ul> <p>When a call for service has occurred, the printer automatically stops printing. Turn off the printer, disconnect the power cable from the outlet and from the AC inlet on the printer, and then reconnect. Turn on the printer again multiple times.</p> <p>If the same call for service is displayed on the screen, contact your dealer or Epson Support for assistance. Tell them the call for service code is "XXXX".</p>
<p>Maintenance Request Code XXXX Refer to the manual.</p>	<p>A part used in the printer is nearing the end of its service life.</p> <p>Contact your dealer or Epson Support and tell them the maintenance request code.</p> <p>You cannot clear the maintenance request until the part is replaced. A service call occurs if you continue to use the printer.</p>



## Problem Solver

# Troubleshooting

## You cannot print (because the printer does not work)

Symptom	What to do
The printer does not turn on.	<p><b>Is the power cable plugged into the electrical outlet or the printer?</b> Make sure the power cable is securely plugged into the printer.</p> <p><b>Is there any problem with the electrical outlet?</b> Make sure your outlet works by connecting the power cable for another electric product.</p>
The printer turns off automatically.	<p><b>Have you set the Power Management setting to Enable?</b> If you do not want the printer to turn off automatically, set this setting to <b>Disable</b>.</p> <p> <a href="#">"Maintenance Mode List" on page 160</a></p>
The printer driver is not installed properly (Windows).	<p><b>Is the printer icon displayed in the Printers or Printers and Faxes folder?</b></p> <p><input type="checkbox"/> Yes</p> <p>The printer driver is installed. See "The printer is not connected correctly to the computer" on the next page.</p> <p><input type="checkbox"/> No</p> <p>The printer driver is not installed. Install the printer driver.</p>
	<p><b>Does the printer port setting match the printer connection port?</b> Check the printer port.</p> <p>Click the <b>Ports</b> tab in the printer driver's Properties screen, and check the <b>Print to the following port(s)</b>.</p> <p><input type="checkbox"/> USB: <b>USB</b> xxx (x stands for the port number) for the USB connection</p> <p><input type="checkbox"/> Network: The correct IP address for the network connection</p> <p>If it is not indicated, the printer driver is not installed correctly. Delete and reinstall the printer driver.</p> <p> <a href="#">"Uninstalling the printer driver" on page 56</a></p>
The printer driver is not installed properly (Mac OS X).	<p><b>Is the printer added to the printer list?</b> Click the Apple Menu, the <b>System Preferences</b> folder, and then the <b>Print &amp; Fax (Print &amp; Scan for Mac OS X v10.7)</b> folder.</p> <p>If the printer name is not displayed, add the printer.</p>

## Problem Solver



Symptom	What to do
The printer is not communicating with the computer.	<p><b>Is the cable plugged in properly?</b> Make sure the printer's interface cable is securely plugged into the correct terminal of the computer and the printer. Also, make sure the cable is not broken nor bent. If you have a spare cable, try connecting with the spare cable.</p> <p><b>Does the interface cable specification match the specifications for the computer?</b> Make sure the interface cable specifications match the specifications for the printer and the computer.</p> <p> <a href="#">"System Requirements" on page 163</a></p> <p><b>Is the interface cable connected directly to the computer?</b> If you use a printer switching device or extension cable between the printer and the computer, you may not be able to print depending on their combinations. Connect the printer and the computer directly with the interface cable and check if you can print normally.</p> <p><b>When using a USB hub, is it being used correctly?</b> In the USB specification, daisy-chains of up to five USB hubs are possible. However, we recommend that you connect the printer to the first hub connected directly to the computer. Depending on the hub you are using, the operation of the printer may become unstable. If this should occur, plug the USB cable directly into your computer's USB port.</p> <p><b>Is the USB hub recognized correctly?</b> Make sure the USB hub is recognized correctly on the computer. If the USB hub is recognized correctly, unplug all of the USB hubs from the computer's USB port, and then connect the printer's USB interface connector directly to the computer's USB port. Ask the USB hub manufacturer about USB hub operation.</p>
You cannot print under the network environment.	<p><b>Are the network settings correct?</b> Ask your network administrator for the network settings.</p> <p><b>Connect the printer directly to the computer using a USB cable, and then try to print.</b> If you can print via USB, there are some problems on the network environment. Ask your system administrator, or refer to the manual for your network system. If you cannot print via USB, see the appropriate section in this User's Guide.</p>
The printer has an error.	<p><b>Confirm if errors have occurred in the printer by checking the lights and messages on the printer's control panel.</b></p> <p> <a href="#">"Control panel" on page 13</a></p> <p> <a href="#">"When an Error Message is Displayed" on page 129</a></p>

## Problem Solver

Symptom	What to do
The printer stops printing.	<p><b>Is the status of print queue Pause? (Windows)</b> If you stop printing or the printer stops printing because of an error, the print queue enters a <b>Pause</b> status. You cannot print in this status.</p> <p>Double-click the printer icon in the <b>Printers</b> folder, and select <b>Pause Printing</b> from the <b>Printer</b> menu to clear the check box.</p> <p><b>Is the status in the Printer Setup Utility (or Print Center) Stopped? (Mac OS X)</b> Mac OS X 10.7, 10.6 and 10.5:</p> <p>If you click <b>Pause Printer</b> in <b>Print &amp; Fax (Print &amp; Scan</b> for Mac OS X v10.7), and then click <b>Open Print Queue</b>, the printer does not start printing until it is released.</p> <ol style="list-style-type: none"> <li>(1) Click the Apple Menu, the <b>System Preferences</b> folder, and then the <b>Print &amp; Fax (Print &amp; Scan</b> for Mac OS X v10.7) folder.</li> <li>(2) Double-click the printer that is <b>Paused</b>.</li> <li>(3) Click <b>Resume Printer</b>.</li> </ol> <p>Mac OS X 10.4:</p> <p>If you click <b>Stop Jobs</b> in the <b>Printer Setup Utility</b>, the printer does not start printing until it is released.</p> <ol style="list-style-type: none"> <li>(1) Double-click the <b>Applications</b> folder, the <b>Utilities</b> folder, and then <b>Printer Setup Utility</b>.</li> <li>(2) Double-click the printer that is <b>Stopped</b>.</li> <li>(3) Click the job that is paused, and then click <b>Start Jobs</b>.</li> </ol> <p>If <b>Printer Setup Utility (or Print Center)</b> is displayed in the Dock, you can follow the steps below.</p> <ol style="list-style-type: none"> <li>(1) Click the <b>Printer Setup Utility (or Print Center)</b> icon in the Dock.</li> <li>(2) Double-click the printer that is <b>Stopped</b>.</li> <li>(3) Click the job that is paused, and then click <b>Start Jobs</b>.</li> </ol>
Your problem is not listed here.	<p><b>Decide whether the trouble is caused by the printer driver or the application. (Windows)</b> Perform a test print from the printer driver so that you can check that the connection between the printer and computer is correct and the printer driver settings are correct.</p> <ol style="list-style-type: none"> <li>(1) Make sure that the printer is turned on and in ready status, and load A4 or larger paper.</li> <li>(2) From the <b>Start</b> menu, open the <b>Printers and Faxes</b> or <b>Printers</b> folder.</li> <li>(3) Right-click the target printer icon, and select <b>Properties</b>.</li> <li>(4) On the <b>General</b> tab, click the <b>Print Test Page</b> button.</li> </ol> <p>After a while the printer starts to print a test page.</p> <ul style="list-style-type: none"> <li><input type="checkbox"/> If the test page is printed correctly, the connection between the printer and computer is correct. Go to the next section.</li> <li><input type="checkbox"/> If the test page is not printed correctly, check the items above again.</li> </ul> <p> <a href="#">"You cannot print (because the printer does not work)" on page 138</a></p> <p>The "Driver Version" shown on the test page is the version number of the Windows internal driver. This differs from the Epson printer driver version that you installed.</p>



## Problem Solver

## The printer sounds like it is printing, but nothing prints





Symptom	What to do
The print head moves, but nothing prints.	<p><b>Confirm the printer operation</b> Print a nozzle check pattern. Because a nozzle check pattern can be printed without connecting to a computer, you can check the operations and print status for the printer.  <a href="#">"Nozzle Check" on page 113</a></p> <p>Check the next section if the nozzle check pattern is not printed correctly.</p> <p><b>Is the message Motor Self Adjustment displayed on the control panel's screen?</b> The printer adjusts the internal motor. Wait for a while without turning off the printer.</p>
The nozzle check pattern is not printed correctly.	<p><b>Perform head cleaning.</b> The nozzles may be clogged. Print a nozzle check pattern again after performing head cleaning.  <a href="#">"Cleaning the print head" on page 115</a></p> <p><b>Has the printer been left unused for a long time?</b> If the printer has not been used for a long time, the nozzles may have dried up and have been clogged. Steps to take when the printer has not been used for a long time  <a href="#">"Notes when not using the printer" on page 20</a></p>

## Problem Solver





## The prints are not what you expected

Symptom	What to do
<p>Print quality is poor, uneven, too light, or too dark.</p>	<p><b>Are the print head nozzles clogged?</b> If the nozzles are clogged, specific nozzles do not fire ink and the print quality declines. Print a nozzle check pattern.  <a href="#">"Nozzle Check" on page 113</a></p> <p><b>Was Head Alignment performed?</b> With bidirectional printing, the print head prints while moving left and right. If the print head is misaligned, ruled lines may be misaligned accordingly. If vertical ruled lines are misaligned with bidirectional printing, perform Head Alignment.  <a href="#">"Correcting Print Misalignment (Print Head Alignment)" on page 117</a></p> <p><b>Are you using a genuine Epson ink cartridge?</b> This printer is developed for use with Epson ink cartridges. If you use non-Epson ink cartridges, the prints may smear, or the color of the printed image may be changed because the remaining ink level is not correctly detected. Be sure to use the correct ink cartridge.</p> <p><b>Are you using an old ink cartridge?</b> The print quality declines when an old ink cartridge is used. Replace the old ink cartridge with a new one. We recommend using the ink cartridge before the expiry date printed on the packaging (within six months after installing in the printer).</p> <p><b>Are the Media Type settings correct?</b> Print quality is affected if the <b>Media Type</b> you have selected in the <b>Main</b> screen (Windows) or Print screen (Mac OS X) in the printer driver does not match with the paper that is loaded in the printer. Be sure to match the media type setting with the paper that is loaded in the printer.</p> <p><b>Did you select a low quality mode (such as Speed) as the Print Quality?</b> The print quality may decline when you select <b>Speed</b> for <b>Print Quality</b> or make <b>Quality Options</b> settings that assign priority to speed from the printer driver. If you want to improve your print quality, select a setting that assigns priority to quality such as <b>Quality</b> or <b>Max Quality</b>.</p> <p><b>Was color management performed?</b> Perform color management.  <a href="#">"Color Management Printing" on page 92</a></p>
<p>Print quality is poor, uneven, too light, or too dark. (Continuation)</p>	<p><b>Have you compared the printing result with the image on the display monitor?</b> Since monitors and printers produce colors differently, printed colors will not always match on-screen colors perfectly.</p> <p><b>Did you open the printer cover while printing?</b> If the printer cover is opened while printing, the print head stops suddenly causing unevenness in the color. Do not open the printer cover while printing.</p> <p><b>Is Ink Low displayed on the control panel's screen?</b> The print quality may decline when the ink is low. We recommend replacing the ink cartridge with a new one. If there is a difference in color after replacing the ink cartridge, try performing head cleaning a few times.</p>

## Problem Solver



Symptom	What to do
The color is not exactly the same as another printer.	<p><b>Colors vary depending on the printer type due to each printer's characteristics.</b> Because inks, printer drivers, and printer profiles are developed for each printer model, the colors printed by different printer models are not exactly the same.</p> <p>You can achieve similar colors with the same color adjustment method or the same gamma setting by using the printer driver.</p> <p> <a href="#">"Color Management Printing" on page 92</a></p> <p>To match the color precisely, use the color measurement device to perform color management.</p>
The print is not positioned properly on the paper.	<p><b>Have you specified the print area?</b> Check the print area in the settings of the application and the printer.</p> <p><b>Is the paper size setting correct?</b> If the <b>Paper Size</b> setting in the printer driver and the size of the loaded paper do not match, the print may not be where you want it, or part of it may be cut off. In this case, check the print settings.</p> <p><b>Is the paper skewed?</b> If <b>Paper Skew Check</b> is set to <b>Off</b> in the Menu, even if it is skewed, the printer exceeds the print area when printing on the paper. Set <b>Paper Skew Check</b> to <b>On</b> in the Menu.</p> <p> <a href="#">"Printer Setup menu" on page 103</a></p> <p><b>Does the print data fit within the paper width?</b> If the print image is larger than the paper width, printing normally stops. However, if <b>Paper Size Check</b> is set to <b>Off</b> in the Menu, the printer prints on the paper exceeding the paper width. Set <b>Paper Size Check</b> to <b>On</b> in the Menu.</p> <p> <a href="#">"Printer Setup menu" on page 103</a></p> <p><b>Is the roll paper margin set to 15 mm or 35 mm?</b> If the value set for <b>Roll Paper Margin</b> in the Menu is larger than the margin settings in the application you are using, the <b>Roll Paper Margin</b> setting is given priority. For example, when left and right margins of 15 mm are set in the Menu, 15 mm on the left and right sides of the page of any data created at the full width of the page in the application are not printed.</p> <p> <a href="#">"Printable area" on page 46</a></p>
Vertical ruled lines are misaligned.	<p><b>Is the print head misaligned? (in bidirectional printing)</b> With bidirectional printing, the print head prints while moving left and right. If the print head is misaligned, ruled lines may be misaligned accordingly. If vertical ruled lines are misaligned with bidirectional printing, perform Head Alignment.</p> <p> <a href="#">"Correcting Print Misalignment (Print Head Alignment)" on page 117</a></p>

## Problem Solver

Symptom	What to do
The printed surface is scuffed or soiled.	<p><b>Is the paper too thick or too thin?</b> Check that the paper specifications are compatible with this printer. For information about the media types and appropriate settings for printing on paper from other manufacturers or when using RIP software, see the manual supplied with the paper, or contact the dealer of the paper or the manufacturer of the RIP.</p> <p><b>Is the paper creased or folded?</b> Do not use old paper or paper with folds in it. Always use new paper.</p> <p><b>Is the paper wavy or slack?</b> Cut sheets become wavy or slack due to changes in temperature or humidity which may result in the printer being unable to recognize the paper size correctly. Flatten the paper before loading it in the printer, or use new paper.</p> <p><b>Is the print head scuffing the printed surface?</b> If the printed surface of the media is being scuffed, set the <b>Platen Gap</b> between <b>Wide</b> and <b>Widest</b> from the Menu.    <a href="#">"Printer Setup menu" on page 103</a></p> <p><b>Is the print head scuffing the edge of the paper?</b> Set the <b>Roll Paper Margin</b> to <b>Top 35/Bottom 15mm</b> from the Menu.    <a href="#">"Printer Setup menu" on page 103</a></p> <p><b>Widen the bottom margin</b> Depending on the paper usage, storage conditions, and the content of the print data, the bottom edge may be scuffed when printing. In this situation it is best to create your data with a wider bottom margin.</p>
The paper is creased.	<p><b>Are you using the printer at normal room temperature?</b> Epson special media should be used at normal room temperature (temperature: 15 to 25 °C, humidity: 40 to 60 %). For information about paper such as thin paper from other manufacturers that requires special handling, see the manual supplied with the paper.</p> <p><b>When using non-Epson special media, have you made the paper configuration?</b> When using non-Epson special media, configure the paper characteristics (custom paper) before printing.    <a href="#">"Before printing on non-Epson media" on page 158</a></p>
The reverse side of the printed paper is soiled.	<p><b>Set Paper Size Check to On in the Menu.</b> If the print image is larger than the paper width, printing normally stops. However, if <b>Paper Size Check</b> is set to <b>Off</b> in the Menu, the printer prints on the paper exceeding the paper width causing the inside of the printer to be soiled. To avoid soiling the inside of the printer, set <b>Paper Size Check</b> to <b>On</b> in the Menu.    <a href="#">"Printer Setup menu" on page 103</a></p> <p><b>Is ink dry on the printed surface?</b> Depending on the printing density and media type, the ink may take a while to dry. Do not stack the paper until the printed surface is dry.   Also, if you set the <b>Drying Time per Page</b> in <b>Paper Configuration</b> from the printer driver, you can stop the operation after printing (ejecting and cutting paper) and wait until the ink is dry. See the printer driver help for more details on the <b>Paper Configuration</b> screen. While drying, the ink drying message is displayed on the screen. You can cancel drying by pressing the OK button.    <a href="#">"Cleaning the inside" on page 127</a></p>









## Problem Solver



Symptom	What to do
Too much ink is fired.	<p><b>Are the Media Type settings correct?</b> Make sure that the printer driver's <b>Media Type</b> settings match the paper that you are using. The amount of ink to be fired is controlled according to the media type. If the settings do not match the paper loaded, too much ink may be fired.</p> <p><b>Is the Color Density setting correct?</b> Lower the density of the ink in the <b>Paper Configuration</b> screen from the printer driver. The printer may be firing too much ink for some paper. See the printer driver help for more details on the <b>Paper Configuration</b> screen.</p>
Margins appear in borderless printing.	<p><b>Are the settings for the print data in the application correct?</b> Make sure that the paper settings in the application are correct as well as in the printer driver.</p> <p> <a href="#">"Borderless printing" on page 68</a></p> <p><b>Are the paper settings correct?</b> Make sure that the paper settings of the printer match the paper that you are using.</p> <p><b>Have you changed the amount of enlargement?</b> Adjust the amount of enlargement for borderless printing. Margins may appear if you set the amount of enlargement to <b>Min</b>.</p> <p> <a href="#">"Borderless printing" on page 68</a></p> <p><b>Is the paper stored correctly?</b> The paper may expand or contract if it is not stored correctly so that margins appear even when borderless is set. See the manual supplied with the paper for more information on the storage method.</p> <p><b>Are you using paper that supports borderless printing?</b> Paper that does not support borderless printing may expand or contract while printing so that margins appear even when borderless is set. We recommend using paper that is designed to support borderless printing.</p> <p><b>Try adjusting the cutter.</b> When there are margins on the top and bottom of the roll paper while performing borderless printing, try performing <b>Cutter Adjustment</b>. It may reduce the margins.</p> <p> <a href="#">"Maintenance menu" on page 105</a></p>

## Problem Solver

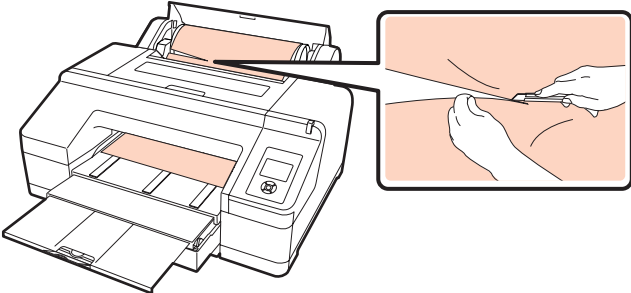
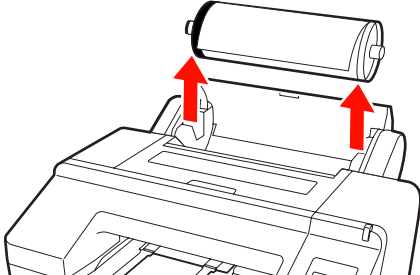
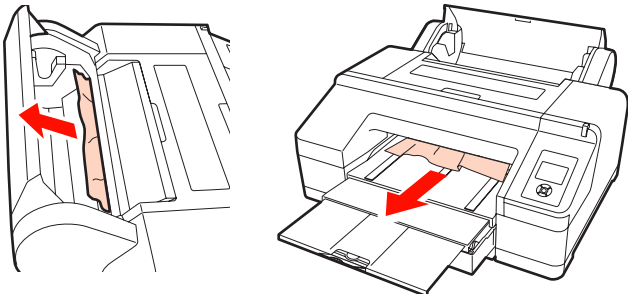
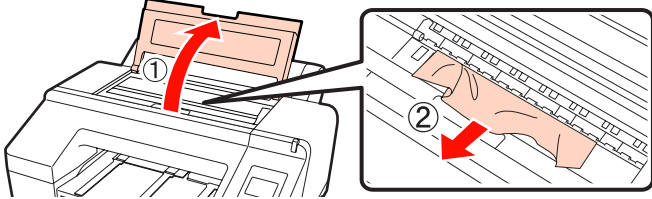

## Feeding or ejecting problems

Symptom	What to do
Unable to feed or eject paper.	<p><b>Is the paper loaded in the correct position?</b> See the following for the correct paper loading positions.</p> <p> <a href="#">"Loading Roll Paper" on page 27</a></p> <p> <a href="#">"Loading Cut Sheets" on page 34</a></p> <p>If the paper is loaded correctly, check the condition of the paper that you are using.</p> <p><b>Is the paper loaded in the correct direction?</b> Load cut sheets vertically. If they are not loaded in the correct direction, the paper is not recognized and an error occurs.</p> <p> <a href="#">"Loading Cut Sheets" on page 34</a></p> <p><b>Are you trying to load cut sheets from the rear manual feeder or the front manual feeder when roll paper has already been loaded?</b> Load cut sheets after selecting <b>Cut Sheet</b> from the Paper Type menu.</p> <p>When <b>Auto Roll Feeding</b> is set to <b>Off</b> from the Menu, remove the roll paper first, and then load cut sheets.</p> <p> <a href="#">"Loading Manually from the Rear" on page 39</a></p> <p> <a href="#">"Loading and Ejecting Thick Paper" on page 40</a></p> <p><b>Is the paper creased or folded?</b> Do not use old paper or paper with folds in it. Always use new paper.</p> <p><b>Is the paper damp?</b> Do not use paper that is damp. Also, Epson special media should be left in the bag until you intend to use it. If it is left out for a long time, the paper curls up and gets damp so that it does not feed properly.</p> <p><b>Is the paper wavy or slack?</b> Cut sheets become wavy or slack due to changes in temperature or humidity which may result in the printer being unable to recognize the paper size correctly. Flatten the paper before loading it in the printer, or use new paper.</p> <p><b>Is the paper too thick or too thin?</b> Check that the paper specifications are compatible with this printer. For information about the media types and appropriate settings for printing on paper from other manufacturers or when using RIP software, see the manual supplied with the paper, or contact the dealer of the paper or the manufacturer of the RIP.</p> <p><b>Are you using the printer at normal room temperature?</b> Epson special media should be used at normal room temperature (temperature: 15 to 25 °C, humidity: 40 to 60 %).</p>
Unable to feed or eject paper. (Continuation)	<p><b>Is paper jammed in the printer?</b> Open the printer cover of the printer and check that there are no paper jams or foreign objects in the printer. If paper is jammed, see "Paper jams" below and clear the jammed paper.</p> <p><b>Is the paper suction too strong?</b> If you continue to have problems with ejected paper, try lowering the Paper Suction (the amount of suction used to keep the paper on the paper feed path).  <a href="#">"Custom Paper" on page 108</a></p>
Unable to rewind the roll paper.	<p><b>Is the printer in standby status after cutting?</b> The roll paper is automatically rewound if you press the  button when the printer is in standby status after cutting the roll paper.</p>

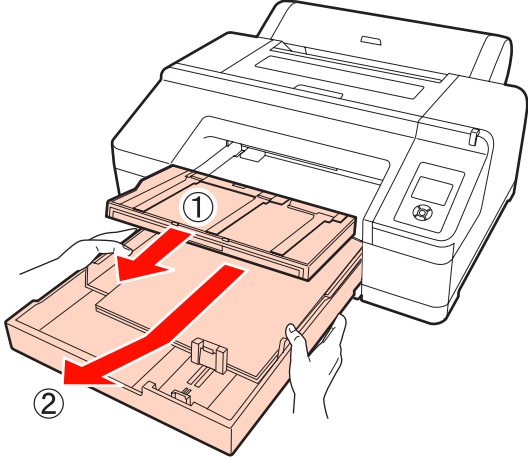
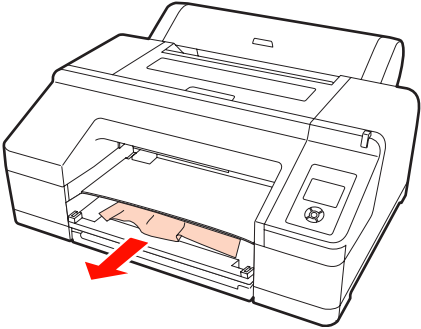
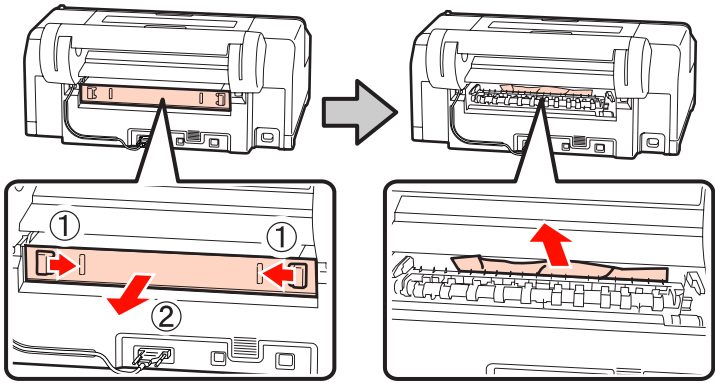

## Problem Solver

Symptom	What to do
Roll paper jam	<p><b>To remove jammed paper, follow the steps below:</b></p> <p>(1) Open the roll paper cover and cut off the paper at the slot of the roll paper feeder using a cutter sold at a store.</p>  <p>(2) Hold both ends of the spindle and lift up from the spindle holder.</p>  <p>(3) Remove the jammed paper from the roll paper feeder/front manual feeder.</p> 
Roll paper jam (Continuation)	<p>(4) Open the printer cover and remove any other jammed paper if necessary.</p>  <p>Turn off the printer, and then turn it back on. Reload the paper and restart printing.</p> <p> <a href="#">"Loading roll paper" on page 29</a></p>



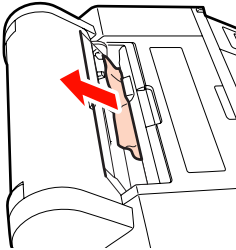
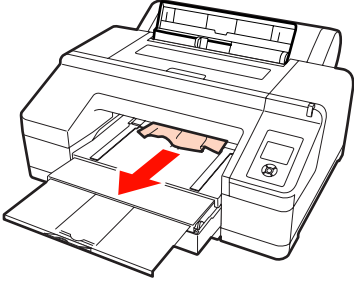
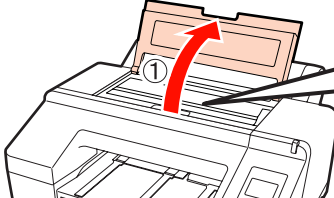
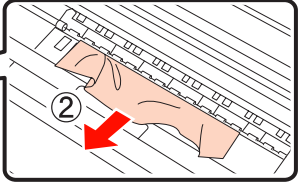

### Problem Solver

Symptom	What to do
<p>Cut sheets from the paper cassette have jammed while printing.</p>	<p><b>To remove jammed paper, follow the steps below:</b></p> <p>(1) Remove the output tray and the paper cassette.</p>  <p>(2) Remove the jammed paper from where the cassette was inserted.</p> 
<p>Cut sheets from the paper cassette have jammed while printing. (Continuation)</p>	<p>(3) If paper is jammed in the rear, remove the rear unit by pulling it towards you with the knob moved to the inside as shown in the figure, and then remove the jammed paper.</p>  <p>(4) Replace the rear unit.</p> <p>With the rear unit's knob moved to the inside, push it into the printer firmly until you hear it click into place.</p> <p>Turn off the printer, and then turn it back on. Reload the paper and restart printing.</p> <p> <a href="#">"Loading the Paper Cassette" on page 35</a></p>

## Problem Solver

Symptom	What to do
Cut sheets from the front/rear manual feeder have jammed.	<p><b>To remove jammed paper, follow the steps below:</b></p> <p>(1) Remove the jammed paper from the rear/front manual feeder.</p>   <p>(2) Open the printer cover and remove any other jammed paper if necessary.</p>   <p>Turn off the printer, and then turn it back on. Reload the paper and restart printing.</p> <p> <a href="#">"Loading Manually from the Rear" on page 39</a></p> <p> <a href="#">"Loading and Ejecting Thick Paper" on page 40</a></p>

## Others

Symptom	What to do
Cannot remove the paper cassette.	<p><b>You may have turned off the printer while an error had occurred.</b> Remove the paper cassette after turning the printer back on and waiting for a few minutes.</p>
The control panel display keeps turning off.	<p><b>Is the printer in sleep mode?</b> The printer returns to its normal status if any operation is performed that involves hardware operations, such as when the screen display is restored by pressing any button on the control panel (except for the  button) followed by pressing the  button, or when a print job is received. You can change the elapsed time before entering sleep mode in the Maintenance Mode menu.</p> <p> <a href="#">"Maintenance Mode List" on page 160</a></p>
Color ink runs out quickly even when printing in the Black mode or when printing black data.	<p><b>Color ink is consumed during the head cleaning process.</b> When performing <b>All Colors</b> or <b>All Colors (Powerful)</b> from <b>Manual Cleaning</b>, all nozzles are cleaned and some ink from all colors is consumed. (Even when Black mode is selected, the ink for all colors is consumed while cleaning.)</p> <p> <a href="#">"Cleaning the print head" on page 115</a></p>
The paper is not cut cleanly.	<p><b>Replace the cutter.</b> If the paper is not cut cleanly, replace the cutter.</p> <p> <a href="#">"Replacing the Cutter" on page 124</a></p>

**Problem Solver**

<b>Symptom</b>	<b>What to do</b>
The red light is on inside the printer.	<b>This is not a failure.</b> The red light is a light inside the printer.
The printer status may not be displayed correctly when using EPSON Status Monitor 3 or EPSON LFP Remote Panel 2 over a network.	<b>Epson Network Utility may not be installed.(Windows)</b> Select Epson Network Utility from the Software List on the <i>Software Disc</i> and install.

# Appendix

## Options and Consumable Products

The following options and consumable products are available for use with your printer. (As of July, 2010)

For the latest information, see the Epson Web site.

Name		Product Code		Explanation
Epson special media		See the following section for media. <a href="#">↗</a> "Epson Special Media Table" on page 153		
Ink cartridges	Color	Epson Stylus Pro 4900	Epson Stylus Pro 4910	Epson recommends the use of genuine Epson ink cartridges. Epson cannot guarantee the quality or reliability of non-genuine ink. The use of non-genuine ink may cause damage that is not covered by Epson's warranties, and under certain circumstances, may cause erratic printer behavior. Information about non-genuine ink levels may not be displayed. <a href="#">↗</a> "Replacing Ink Cartridges" on page 120
	Green	T653B	T655B	
	Light Light Black	T6539	T6559	
	Yellow	T6534	T6554	
	Light Cyan	T6535	T6555	
	Vivid Light Magenta	T6536	T6556	
	Orange	T653A	T655A	
	Matte Black	T6538	T6558	
	Vivid Magenta	T6533	T6553	
	Light Black	T6537	T6557	
	Cyan	T6532	T6552	
Photo Black	T6531	T6551		
Maintenance Box (Maintenance Box 1)	T6190		Replacement Maintenance Box for Maintenance Box 1 which is at the end of its service life. <a href="#">↗</a> "Replacing Maintenance Box 1" on page 121	
Borderless Maintenance Box (Maintenance Box 2)	T6191		Replacement Maintenance Box for Maintenance Box 2 which is at the end of its service life. <a href="#">↗</a> "Replacing Maintenance Box 2" on page 122	
Auto Cutter Spare Blade	C12C815351		See the following section to replace the cutter. <a href="#">↗</a> "Replacing the Cutter" on page 124	

## Appendix

Name	Product Code	Explanation
2/3" Dual Roll Feed Spindle	C12C811251	Same as the spindle supplied with the printer.
Borderless Print Spacer	C12C811201	Same as the Borderless Print Spacer supplied with the printer.
Roll Paper Belt	C12C890121	
SpectroProofer Mounter 17"	C12C890631	<p>Automates the color management process when installed on the printer.</p> <p>Refer to the manual supplied with the SpectroProofer Mounter for more information on how to install and use it.</p>



## Appendix

## Supported Media

We recommend you use the following Epson special media for high-quality printing results.

**Tip:**

For information about the media types and appropriate settings for printing on paper other than Epson special media or when using raster image processing (RIP) software, see the manual supplied with the paper, or contact the dealer of the paper or the manufacturer of the RIP.

**Item descriptions**

Name: Describes the media name.

Size: Describes the size for cut sheet media or the width for roll paper.

Thickness: Describes the thickness of the media.

Core: Describes the core size of the roll paper.

Borderless: Describes whether borderless printing is available.

Cassette: Describes if paper can be loaded in the paper cassette. For cut sheets only.

Capacity: Describes how many sheets can be loaded in the paper cassette. For cut sheets only.

Black ink: Describes the type of black ink that can be used with the loaded media.

ICC Profile: Describes the ICC profile for the media. The file name of the profile is used as the profile name in the printer driver or the application.

---

## Epson Special Media Table

### Roll paper

PK: Photo Black/MK: Matte Black

Name	Size	Thickness	Core	Borderless	Black ink	ICC Profile
Premium Glossy Photo Paper (250)	406 mm/16"	0.27 mm	3"	✓	PK	Epson Stylus Pro 4900_4910 PremiumGlossyPhotoPaper250.icc
Premium Semigloss Photo Paper (250)	406 mm/16"	0.27 mm	3"	✓	PK	Epson Stylus Pro 4900_4910 PremiumSemiglossPhotoPaper250.icc
Premium Luster Photo Paper (260)	254 mm/10"	0.27 mm	3"	✓	PK	Epson Stylus Pro 4900_4910 PremiumLusterPhotoPaper260.icc
	300 mm					
	406 mm/16"					

## Appendix

Name	Size	Thickness	Core	Borderless	Black ink	ICC Profile
Premium Semimatte Photo Paper (260)	406 mm/16"	0.27 mm	3"	✓	PK	Epson Stylus Pro 4900_4910 PremiumSemimattePhotoPaper260.icc
Photo Paper Gloss 250	432 mm/17"	0.25 mm	3"	✓	PK	Epson Stylus Pro 4900_4910 PhotoPaperGloss250.icc
Premium Glossy Photo Paper (170)	420 mm (A2)	0.18 mm	2"	✓ <sup>*1</sup>	PK	Epson Stylus Pro 4900_4910 PremiumGlossyPhotoPaper170.icc
Premium Semigloss Photo Paper (170)	420 mm (A2)	0.18 mm	2"	✓ <sup>*1</sup>	PK	Epson Stylus Pro 4900_4910 PremiumSemiglossPhotoPaper170.icc
Enhanced Matte Paper	432 mm/17"	0.25 mm	3"	✓ <sup>*2</sup>	MK	Epson Stylus Pro 4900_4910 EnhancedMattePaper_MK.icc
Singleweight Matte Paper	432 mm/17"	0.14 mm	2"	✓	MK	Epson Stylus Pro 4900_4910 SingleweightMattePaper.icc
Epson Proofing Paper Commercial	329 mm/13"	0.20 mm	3"	✓ <sup>*2</sup>	PK	Epson Stylus Pro 4900_4910 EpsonProofingPaperCommercial.icc
	432 mm/17"					
Epson Proofing Paper White Semimatte	329 mm/13"	0.25 mm	3"	✓ <sup>*2</sup>	PK	Epson Stylus Pro 4900_4910 EpsonProofingPaperWhiteSemimatte.icc
	432 mm/17"					
Epson Proofing Paper Publication	329 mm/13"	0.20 mm	3"	✓ <sup>*2</sup>	PK	Epson Stylus Pro 4900_4910 EpsonProofingPaperPublication.icc
	432 mm/17"					
UltraSmooth Fine Art Paper	432 mm/17"	0.46 mm	3"	✓ <sup>*2</sup>	PK/MK	Epson Stylus Pro 4900_4910 UltraSmoothFineArtPaper_PK.icc/ Epson Stylus Pro 4900_4910 UltraSmoothFineArtPaper_MK.icc
		0.37 mm				
Textured Fine Art Paper	432 mm/17"	0.37 mm	3"	✓ <sup>*2</sup>	PK/MK	Epson Stylus Pro 4900_4910 TexturedFineArtPaper_PK.icc/ Epson Stylus Pro 4900_4910 TexturedFineArtPaper_MK.icc

\*1 You can perform borderless printing by using the borderless printing spacer supplied with the printer.

 [“Removing and installing the spacer” on page 28](#)

\*2 You can specify and perform borderless printing; however, margins may appear or the print quality may decline due to the paper expanding or contracting.

## Cut sheet

Borderless printing with cut sheets can only be performed with no left and right margins.

## Appendix

PK: Photo Black/MK: Matte Black

Name	Size	Thickness	Border less	Cassette	Capacity	Black ink	ICC Profile
Premium Glossy Photo Paper	8" x 10"	0.27 mm	-	✓	100	PK	Epson Stylus Pro 4900_4910 PremiumGlossyPhotoPaper.icc
	A4		✓				
	Letter (8.5" x 11")		-		50		
	11" x 14"		-		20		
	USB (11" x 17")		-				
	A3		✓				
	Super A3/B (329 x 483 mm)		✓		25		
	A2		-				
	USC (17" x 22")		✓				
Premium Semigloss Photo Paper	A4	0.27 mm	✓	✓	100	PK	Epson Stylus Pro 4900_4910 PremiumSemiglossPhotoPaper.icc
	Letter (8.5" x 11")		-				
	A3		✓				
	Super A3/B (329 x 483 mm)		✓				
	A2		-				
	USC (17" x 22")		✓				
Premium Luster Photo Paper	A4	0.27 mm	✓	✓	100	PK	Epson Stylus Pro 4900_4910 PremiumLusterPhotoPaper.icc
	Letter (8.5" x 11")		-				
	A3		✓				
	Super A3/B (329 x 483 mm)		✓				
	A2		-				
	USC (17" x 22")		✓				

## Appendix

Name	Size	Thickness	Border less	Cassette	Capacity	Black ink	ICC Profile
Archival Matte Paper/ Enhanced Matte Paper	A4	0.26 mm	✓*	✓	100	MK	Epson Stylus Pro 4900_4910 ArchivalMattePaper_MK.icc/ Epson Stylus Pro 4900_4910 EnhancedMattePaper_MK.icc
	Letter (8.5" x 11")		-				
	A3		✓*				
	Super A3/B (329 x 483 mm)		-		50		
	A2		✓*				
	USC (17" x 22")		-				
Photo Quality Inkjet Paper	A4	0.12 mm	✓*	✓	100	MK	Epson Stylus Pro 4900_4910 PhotoQualityInkJetPaper.icc
	Letter (8.5" x 11")		-				
	US B/11"		✓*				
	A3		-				
	Super A3/B (329 x 483 mm)		✓*		30		
	A2		✓*				
	USC (17" x 22")		-				
EPSON Proofing Paper White Semimatte	Super A3/B (329 x 483 mm)	0.25 mm	✓*	✓	100	PK	Epson Stylus Pro 4900_4910 EpsonProofingPaperWhiteSemimatte.icc
	SuperW A3 (329 x 559 mm)		✓*				
Watercolor Paper - Radiant White	Super A3/B (329 x 483 mm)	0.29 mm	✓*	-	-	PK/MK	Epson Stylus Pro 4900_4910 WatercolorPaper-RadiantWhite_PK.icc/ Epson Stylus Pro 4900_4910 WatercolorPaper-RadiantWhite_MK.icc
UltraSmooth Fine Art Paper	Super A3/B (329 x 483 mm)	0.32 mm	✓*	-	-	PK/MK	Epson Stylus Pro 4900_4910 UltraSmoothFineArtPaper_PK.icc/ Epson Stylus Pro 4900_4910 UltraSmoothFineArtPaper_MK.icc
	A2		-				
	USC (17" x 22")		✓*				

## Appendix

Name	Size	Thickness	Border less	Cassette	Capacity	Black ink	ICC Profile
Velvet Fine Art Paper	Letter (8.5" x 11")	0.48 mm	-	-	-	PK/MK	Epson Stylus Pro 4900_4910 VelvetFineArtPaper_PK.icc/ Epson Stylus Pro 4900_4910 VelvetFineArtPaper_MK.icc
	Super A3/B (329 x 483 mm)		✓*				
	A2		-				
	USC (17" x 22")		✓*				

\* You can specify and perform borderless printing; however, margins may appear or the print quality may decline due to the paper expanding or contracting.

## Appendix

## Usable Commercially Available Paper Size

This printer supports the following paper specifications for non-Epson media.

**Note:**

- ❑ Do not use paper that is wrinkled, scuffed, torn, or dirty.
- ❑ Although plain paper and recycled paper manufactured by other companies can be loaded and fed in the printer as long as they meet the following specifications, Epson cannot guarantee the print quality.
- ❑ Although other paper types manufactured by other companies can be loaded in the printer as long as they meet the following specifications, Epson cannot guarantee the paper feeding and print quality.

### Roll paper

Media types	Plain paper and recycled paper
Paper core size	2 inch and 3 inch
Roll paper outer diameter	2 inch core: 103 mm or less 3 inch core: 105 mm or less
Roll paper size	2-inch paper core: 203 to 432 mm x 45 m <sup>*1</sup> 3-inch paper core: 203 to 432 mm x 30.5 m <sup>*1</sup>
Paper Thickness	0.08 to 0.11 mm (Weight 64 to 90 g/m <sup>2</sup> )
Available width for borderless printing	A4/210 mm A3/297 mm Super A3/B/329 mm SuperW A3/329 mm A2/420 mm <sup>*2</sup> 11 inch <sup>*2</sup> 17 inch 8 inch <sup>*2</sup> 10 inch 16 inch 30 cm

- \*1 The print lengths differ depending on the OS used as follows.

When using an application that supports banner printing, you can print beyond the values given below. However, the lengths that can be printed differ depending on the specifications of the application, the computing environment, and so on.

Windows: 127 to 15000 mm

Mac OS X: 127 to 15240 mm

- \*2 You can only perform borderless printing when using the borderless printing spacer supplied with the printer and when you have loaded the roll paper with a 2 inch paper core.

 [“Removing and installing the spacer” on page 28](#)

### Cut sheet

Media types	Plain paper and recycled paper
Paper Size	Width: 203 to 432 mm Length: 254 to 610 mm (8 inch to Super A2)
Paper Thickness	0.08 to 0.11 mm (Weight 64 to 90 g/m <sup>2</sup> )
Available width for borderless printing	A4/210 mm A3/297 mm Super A3/B/329 mm SuperW A3/329 mm 17 inch 10 inch 16 inch 30 cm

## Before printing on non-Epson media

When using non-Epson media (Custom Paper), make the paper configuration according to the paper characteristics before printing. You can make settings using the following two methods.

## Appendix

- ❑ Setting with **Custom Paper** in the Menu, or from EPSON LFP Remote Panel 2 and saving to this printer

 “Paper Setup menu” on page 106

- ❑ Setting with the printer driver and saving to your computer

Windows: Set **Custom Settings** items in the **Main** screen and then save.

 “Saving media settings” on page 53

Mac OS X: Set in the **Paper Configuration** screen.

See the printer driver help for more details.

When Custom Paper settings are made both in the printer's Menu and in the printer driver, the printer driver settings are given priority when printing from the printer driver.





**Tip:**

- ❑ *Be sure to check the paper characteristics such as paper tension, ink fixating, or paper thickness before setting the custom paper. For the paper's characteristics, check the paper's manual or with your local dealer.*
- ❑ *Test the print quality with this printer before purchasing a large amount of paper.*
- ❑ *If colors in printed images on the custom paper are uneven, use unidirectional printing. For unidirectional printing, select the **Main** screen - **Print Quality** - **Quality Options** from the printer driver (for Windows), or **Print Settings** (for Mac OS X), and then clear the **High Speed** check box.*

## Maintenance Mode

You can change the language or units used on the display, or restore all settings to the factory settings.

### Starting and Ending Maintenance Mode

- 1 Turn off the printer.
- 2 Hold down the  button and press the  button. When the  light turns on, release only the  button. When the **Maintenance Mode** screen is displayed, release the  button.

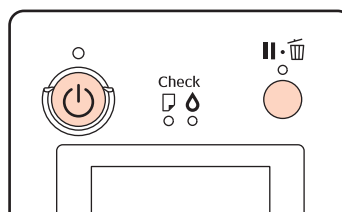

See the "Maintenance Mode List" below for details on the Maintenance Mode settings.

- 3 To close Maintenance Mode, turn off the printer.

## Appendix

## Maintenance Mode List

The factory setting is  .

Item	Parameter	Explanation
Language	Japanese	Select the language used on the control panel's screen.
	English	
	French	
	Italian	
	German	
	Portuguese	
	Spanish	
	Dutch	
	Korean	
	Chinese	
Length Units	Metric	Select the unit of length which is displayed on the control panel's screen or printed on the patterns.
	Feet/Inch	
Temperature Units	°C	Select the unit of temperature which is displayed on the control panel's screen or printed on the patterns.
	F	
Auto Cleaning Times	1	The number of times to perform auto cleaning when a clog was detected after performing an auto nozzle check.
	2	
	3	
Maintenance Alert	Disable	The type of running low warnings to display by the alert lamp. If set to <b>Disable</b> , the alert lamp does not display any running low warnings.
	Ink	The alert lamp flashes when running low on ink.
	Maintenance Box	The alert lamp flashes when Maintenance Box 1/2 does not have enough empty space.
	Ink Or Maint Box	The alert lamp flashes when running low on ink or when Maintenance Box 1/2 does not have enough empty space.
	Papers	If either <b>Roll Paper Remaining</b> or <b>Cut Sheet Remaining</b> is set, the alert lamp flashes when either of these reaches their respective warning levels.
	All	The alert lamp flashes when running low on ink, when Maintenance Box 1/2 does not have enough empty space, or when running low on paper.



## Appendix

Item	Parameter		Explanation
Cut Sheet Remaining	Off		Choose whether or not to show <b>(On/Off) Cut Sheet Remaining</b> in the Menu. When set to <b>On, Cut Sheet Remaining</b> is displayed in the Menu, from which you can set the number of pages to trigger a running low warning and the number of pages loaded in the paper cassette.
	On		
Sleep Mode	5 minutes		The printer enters sleep mode when there are no errors, no print jobs being received, and no control panel or other operations performed. This setting allows you to select how many minutes to wait until automatically entering sleep mode.   <a href="#">"Turning Off the Power Using Power Management" on page 49</a>
	15 minutes		
	60 minutes		
	120 minutes		
	180 minutes		
Power Management	Power Off Timer	Disable	The printer turns off automatically when there are no errors, no print jobs being received, and no control panel or other operations are performed for eight hours.  To change the amount of time required until the printer is turned off completely, set the desired time in the <b>Time To Off</b> setting. You can specify between 1 and 24 hours at intervals of 1 hour for the <b>Time To Off</b> setting.  If you do not want the printer to automatically turn itself off, set <b>Power Off Timer</b> to <b>Disable</b> .
		Enable	
	Time To Off	1 to 24hour(s)	
Default Panel	Execute		Restores all settings, such as configurable control panel items and paper settings, to their factory settings.
Custom	0 to 255		Only modify these settings if instructed to do so by a member of our support staff.  This is not normally used.

**About Power Management**

You can adjust the time before Power Management is applied.

Any increase will affect the printer's energy efficiency.

Please consider the environment before making any change.

## Notes When Moving or Transporting the Printer

Perform the following operations when moving or transporting the printer.

As shown below, always lift the printer by placing your hands in the indentations on the left and right sides.

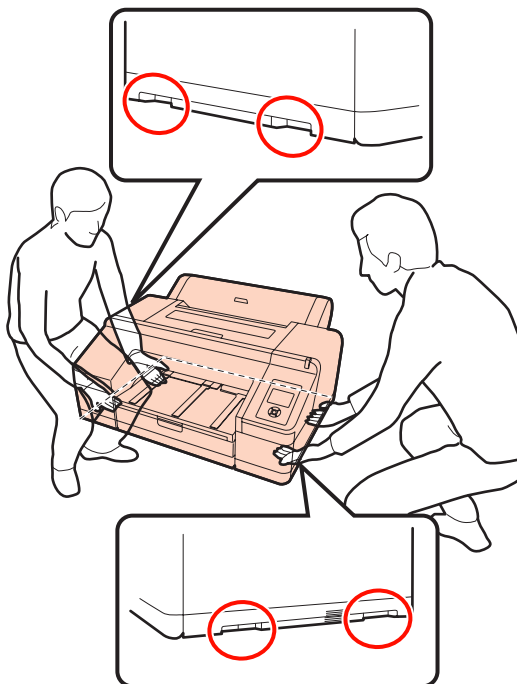

**Note:**

- Only hold the required area; otherwise, the printer may be damaged.
- Move and transport the printer with ink cartridges installed. Do not remove the ink cartridges; otherwise, the nozzles may be clogged and make it impossible to print, or ink may leak.

## Before Moving or Transporting

Make the following preparations in advance before moving or transporting the printer.

- Turn off the printer and remove all cables.
- Remove any paper.
- Remove any optional components if they are installed.

## Notes on Transporting

When transporting the printer, repack it using the original box and packing materials to protect it from shock and vibration.

## After Moving or Transporting

After moving or transporting, check if the print head is clogged before use.

 [“Checking for clogged nozzles” on page 113](#)

## Appendix

## System Requirements

The following system requirements are necessary to install and use the software for this printer.

### Windows

Operating system	Windows XP/Windows XP x64 Windows Vista Windows 7
CPU	Pentium® 4 2.0 GHz or higher
Memory	1 GB or more
Available hard disk space	32 GB or more
Interface	Hi-Speed USB-Compatible with the USB 2.0 Specification. Ethernet 10BASE-T, 100BASE-TX*
Display resolution	SVGA (800 x 600) or higher resolution

\* Use a shielded twisted-pair cable (Category 5 or higher).

**Tip:**

*When installing, you must log in as a user with an Administrator account (a user belonging to the Administrators group).*

### Mac OS X

Operating system	Mac OS X 10.4.11 to 10.7
CPU	PowerPC G5 2 GHz or higher or an Intel processor
Memory	1GB or more
Available hard disk space	32 GB or more
Display resolution	Mac OS X 10.7, 10.6 and 10.5: WXGA (1280 x 800) or higher resolution Mac OS X 10.4.x: XGA (1024 x 768) or higher resolution
Interface	Hi-Speed USB-Compatible with the USB 2.0 Specification. Ethernet 10BASE-T, 100BASE-TX*

\* Use a shielded twisted-pair cable (Category 5 or higher).

## Specifications Table

Printer Specifications	
Printing method	On-demand ink jet
Nozzle configuration	Black: 360 nozzles x 3 (Photo Black/Matte Black,Light Light Black, Light Black)
	Color: 360 nozzles x 7 (Green, Yellow, Light Cyan, Vivid Light Magenta, Orange, Vivid Magenta, Cyan)
Resolution (maximum)	2880 x 1440 dpi
Control code	ESC/P raster (undisclosed command)
Paper feed method	Friction feed
Built-in memory	256 MB for Main 64 MB for Network
Rated voltage	AC 100 to 240 V
Rated frequency range	50 to 60 Hz
Rated current	0.7 to 0.4A
Power consumption	Printing: Approx. 52 W/Approx. 55 W (When the optional SpectroProofer is installed) Sleep mode: Approx. 8.5 W Power off: 0.5 W or less
Temperature	Operating: 10 to 35 °C (50 to 95°F) Storage (before unpacking): -20 to 60 °C (-4 to 140°F) (within 120 hours at 60 °C (140°F), within a month at 40 °C (104°F)) Storage (after unpacking): -20 to 40 °C (-4 to 104°F) (within a month at 40 °C (104°F))
Humidity	Operating: 20 to 80 % (without condensation) Storage (before unpacking): 5 to 85 % (without condensation) Storage (after unpacking): 5 to 85 % (without condensation)

Appendix

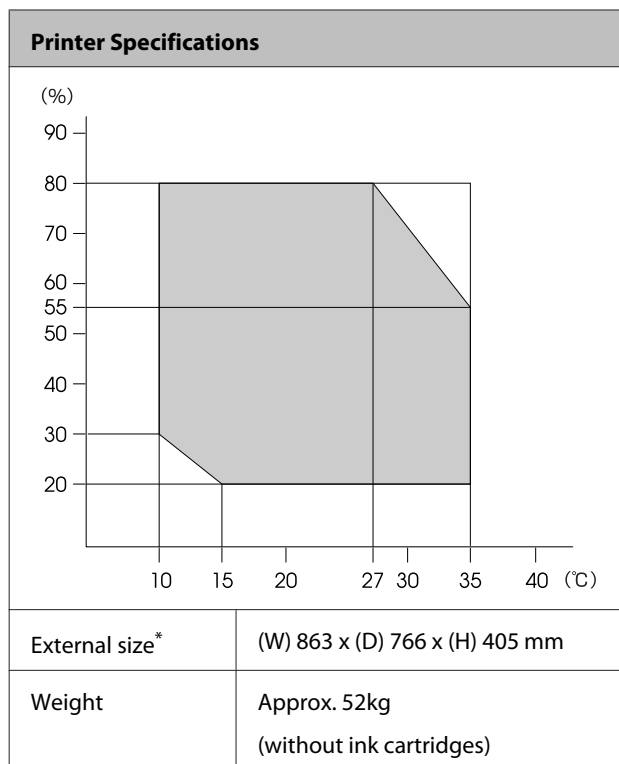

\* When the paper cassette and output tray are stored

**Ink Specifications**

Type	Special ink cartridges
Pigment ink	Black: Photo Black, Matte Black, Light Black, Light Light Black Color: Green, Yellow, Orange, Cyan, Light Cyan, Vivid Magenta, Vivid Light Magenta
Use by date	See the date printed on the package (at normal temperature)
Print quality guarantee expiry	Six months (after installing in the printer)
Storage temperature	Uninstalled: -20 to 40 °C (within a month at 40 °C) Installed: -20 to 40 °C (within a month at 40 °C) Transporting: -20 to 60 °C (within a month at 40 °C, within 72 hours at 60 °C)
Cartridge dimensions	200 ml: (W) 25 x (D) 200 x (H) 100 mm

**Note:**

- The ink freezes if left at below -15 °C for a long time. If it does freeze, leave it at room temperature (25 °C) for at least four hours (without condensation).
- Do not refill the ink.

**Standards and Approvals**

Safety	UL 60950-1	
	CAN/CSA C22.2 No.60950-1	
	Low Voltage Directive 2006/95/EC	EN 60950-1
EMC	FCC part 15 subpart B Class B	
	CAN/CSA-CEI/IEC CISPR 22 Class B	
	AS/NZS CISPR 22 Class B	
	EMC Directive 2004/108/EC	EN 55022 Class A
		EN 55024
EN 61000-3-2		
EN 61000-3-3		

**For Users in Europe**



**Warning:**

*This is a class A product. In a domestic environment this product may cause radio interference in which case the user may be required to take adequate measures.*

---

## Where To Get Help

---

### Technical Support Web Site

Epson's Technical Support Web Site provides help with problems that cannot be solved using the troubleshooting information in your product documentation. If you have a Web browser and can connect to the Internet, access the site at:

<http://support.epson.net/>

If you need the latest drivers, FAQs, manuals, or other downloadables, access the site at:

<http://www.epson.com>

Then, select the support section of your local Epson Web site.

## Contacting Epson Support

---

### Before Contacting Epson

If your Epson product is not operating properly and you cannot solve the problem using the troubleshooting information in your product documentation, contact Epson support services for assistance. If Epson support for your area is not listed below, contact the dealer where you purchased your product.

Epson support will be able to help you much more quickly if you give them the following information:

- Product serial number  
(The serial number label is usually on the back of the product.)
- Product model
- Product software version  
(Click **About**, **Version Info**, or similar button in the product software.)
- Brand and model of your computer
- Your computer operating system name and version
- Names and versions of the software applications you normally use with your product

## Where To Get Help

### Help for Users in North America

Epson provides the technical support services listed below.

#### Internet Support

Visit Epson's support website at <http://epson.com/support> and select your product for solutions to common problems. You can download drivers and documentation, get FAQs and troubleshooting advice, or e-mail Epson with your questions.

#### Speak to a Support Representative

Dial: (562) 276-1300 (U.S.), or (905) 709-9475 (Canada), 6 am to 6 pm, Pacific Time, Monday through Friday. Days and hours of support are subject to change without notice. Toll or long distance charges may apply.

Before you call Epson for support, please have the following information ready:

- Product name
- Product serial number
- Proof of purchase (such as a store receipt) and date of purchase
- Computer configuration
- Description of the problem

**Note:**

For help using any other software on your system, see the documentation for that software for technical support information.

#### Purchase Supplies and Accessories

You can purchase genuine Epson ink cartridges, ribbon cartridges, paper, and accessories from an Epson authorized reseller. To find the nearest reseller, call 800-GO-EPSON (800-463-7766). Or you can purchase online at <http://www.epsonstore.com> (U.S. sales) or <http://www.epson.ca> (Canadian sales).

### Help for Users in Europe

Check your **Pan-European Warranty Document** for information on how to contact Epson support.

### Help for Users in Taiwan

Contacts for information, support, and services are:

#### World Wide Web (<http://www.epson.com.tw>)

Information on product specifications, drivers for download, and products enquiry are available.

#### Epson HelpDesk (Phone: +0800212873)

Our HelpDesk team can help you with the following over the phone:

- Sales enquiries and product information
- Product usage questions or problems
- Enquiries on repair service and warranty

#### Repair service center:

Telephone number	Fax number	Address
02-23416969	02-23417070	No.20, Beiping E. Rd., Zhongzheng Dist., Taipei City 100, Taiwan
02-27491234	02-27495955	1F., No.16, Sec. 5, Nanjing E. Rd., Songshan Dist., Taipei City 105, Taiwan
02-32340688	02-32345299	No.1, Ln. 359, Sec. 2, Zhongshan Rd., Zhonghe City, Taipei County 235, Taiwan
039-605007	039-600969	No.342-1, Guangrong Rd., Luodong Township, Yilan County 265, Taiwan
038-312966	038-312977	No.87, Guolian 2nd Rd., Hualien City, Hualien County 970, Taiwan
03-2810606	03-2810707	No.413, Huannan Rd., Pingzhen City, Taoyuan County 324, Taiwan

## Where To Get Help

Telephone number	Fax number	Address
03-5325077	03-5320092	1F., No.9, Ln. 379, Sec. 1, Jinguo Rd., North Dist., Hsinchu City 300, Taiwan
04-23291388	04-23291338	3F., No.510, Yingcai Rd., West Dist., Taichung City 403, Taiwan
04-23805000	04-23806000	No.530, Sec. 4, Henan Rd., Nantun Dist., Taichung City 408, Taiwan
05-2784222	05-2784555	No.463, Zhongxiao Rd., East Dist., Chiayi City 600, Taiwan
06-2221666	06-2112555	No.141, Gongyuan N. Rd., North Dist., Tainan City 704, Taiwan
07-5520918	07-5540926	1F., No.337, Minghua Rd., Gushan Dist., Kaohsiung City 804, Taiwan
07-3222445	07-3218085	No.51, Shandong St., Sanmin Dist., Kaohsiung City 807, Taiwan
08-7344771	08-7344802	1F., No.113, Shengli Rd., Pingtung City, Pingtung County 900, Taiwan

## Help for Users in Australia

Epson Australia wishes to provide you with a high level of customer service. In addition to your product documentation, we provide the following sources for obtaining information:

### Your Dealer

Don't forget that your dealer can often help identify and resolve problems. The dealer should always be the first call for advice on problems; they can often solve problems quickly and easily as well as give advice on the next step to take.

## Internet URL

<http://www.epson.com.au>

Access the Epson Australia World Wide Web pages. Worth taking your modem here for the occasional surf! The site provides a download area for drivers, Epson contact points, new product information and technical support (e-mail).

## Epson Helpdesk

Epson Helpdesk is provided as a final backup to make sure our clients have access to advice. Operators on the Helpdesk can aid you in installing, configuring and operating your Epson product. Our Pre-sales Helpdesk staff can provide literature on new Epson products and advise where the nearest dealer or service agent is located. Many types of queries are answered here.

The Helpdesk numbers are:

Phone: 1300 361 054

Fax: (02) 8899 3789

We encourage you to have all the relevant information on hand when you ring. The more information you prepare, the faster we can help solve the problem. This information includes your Epson product documentation, type of computer, operating system, application programs, and any information you feel is required.

## Help for Users in Singapore

Sources of information, support, and services available from Epson Singapore are:

### World Wide Web

<http://www.epson.com.sg>

Information on product specifications, drivers for download, Frequently Asked Questions (FAQ), Sales Enquiries, and Technical Support via e-mail are available.

### Epson HelpDesk

**(Phone: (65) 6586 3111)**

Our HelpDesk team can help you with the following over the phone:

## Where To Get Help

- Sales enquiries and product information
- Product usage questions or problems
- Enquiries on repair service and warranty

---

### Help for Users in Thailand

Contacts for information, support, and services are:

#### World Wide Web

(<http://www.epson.co.th>)

Information on product specifications, drivers for download, Frequently Asked Questions (FAQ), and e-mail are available.

#### Epson Hotline

**(Phone: (66)2685-9899)**

Our Hotline team can help you with the following over the phone:

- Sales enquiries and product information
- Product usage questions or problems
- Enquiries on repair service and warranty

---

### Help for Users in Vietnam

Contacts for information, support, and services are:

Epson Hotline (Phone): 84-8-823-9239

Service Center: 80 Truong Dinh Street,  
District 1, Hochiminh City  
Vietnam

---

### Help for Users in Indonesia

Contacts for information, support, and services are:

#### World Wide Web

(<http://www.epson.co.id>)

- Information on product specifications, drivers for download

- Frequently Asked Questions (FAQ), Sales Enquiries, questions through e-mail

#### Epson Hotline

- Sales enquiries and product information
- Technical support

Phone (62) 21-572 4350

Fax (62) 21-572 4357

#### Epson Service Center

Jakarta Mangga Dua Mall 3rd floor No 3A/B  
Jl. Arteri Mangga Dua,  
Jakarta

Phone/Fax: (62) 21-62301104

Bandung Lippo Center 8th floor  
Jl. Gatot Subroto No.2  
Bandung

Phone/Fax: (62) 22-7303766

Surabaya Hitech Mall It IIB No. 12  
Jl. Kusuma Bangsa 116 – 118  
Surabaya

Phone: (62) 31-5355035  
Fax: (62)31-5477837

Yogyakarta Hotel Natour Garuda  
Jl. Malioboro No. 60  
Yogyakarta

Phone: (62) 274-565478

Medan Wisma HSBC 4th floor  
Jl. Diponegoro No. 11  
Medan

Phone/Fax: (62) 61-4516173

Makassar MTC Karebosi Lt. Ill Kav. P7-8  
Jl. Ahmad Yani No.49  
Makassar

Phone: (62)411-350147/411-350148



## Where To Get Help

### Help for Users in Hong Kong

To obtain technical support as well as other after-sales services, users are welcome to contact Epson Hong Kong Limited.

#### Internet Home Page

Epson Hong Kong has established a local home page in both Chinese and English on the Internet to provide users with the following information:

- Product information
- Answers to Frequently Asked Questions (FAQs)
- Latest versions of Epson product drivers

Users can access our World Wide Web home page at:

<http://www.epson.com.hk>

#### Technical Support Hotline

You can also contact our technical staff at the following telephone and fax numbers:

Phone: (852) 2827-8911

Fax: (852) 2827-4383

### Help for Users in Malaysia

Contacts for information, support, and services are:

#### World Wide Web

<http://www.epson.com.my>

- Information on product specifications, drivers for download
- Frequently Asked Questions (FAQ), Sales Enquiries, questions through e-mail

#### Epson Trading (M) Sdn. Bhd.

Head Office.

Phone: 603-56288288

Fax: 603-56288388/399

#### Epson Helpdesk

- Sales enquiries and product information (Infoline)

Phone: 603-56288222

- Enquiries on repair services & warranty, product usage and technical support (Techline)

Phone: 603-56288333

### Help for Users in India

Contacts for information, support, and services are:

#### World Wide Web

<http://www.epson.co.in>

Information on product specifications, drivers for download, and products enquiry are available.

#### Epson India Head Office - Bangalore

Phone: 080-30515000

Fax: 30515005

#### Epson India Regional Offices:

Location	Telephone number	Fax number
Mumbai	022-28261515 / 16/17	022-28257287
Delhi	011-30615000	011-30615005
Chennai	044-30277500	044-30277575
Kolkata	033-22831589 / 90	033-22831591
Hyderabad	040-66331738/ 39	040-66328633
Cochin	0484-2357950	0484-2357950
Coimbatore	0422-2380002	NA

## Where To Get Help

Location	Telephone number	Fax number
Pune	020-30286000 / 30286001 /30286002	020-30286000
Ahmedabad	079-26407176 / 77	079-26407347

### Helpline

For Service, Product info or to order a cartridge -  
18004250011 (9AM - 9PM) - This is a Toll-free number.

For Service (CDMA & Mobile Users) - 3900 1600 (9AM  
- 6PM) Prefix local STD code

### Help for Users in the Philippines

To obtain technical support as well as other after sales services, users are welcome to contact the Epson Philippines Corporation at the telephone and fax numbers and e-mail address below:

Trunk Line: (63-2) 706 2609

Fax: (63-2) 706 2665

Helpdesk (63-2) 706 2625  
Direct Line:

E-mail: [epchelpdesk@epc.epson.com.ph](mailto:epchelpdesk@epc.epson.com.ph)

### World Wide Web

(<http://www.epson.com.ph>)

Information on product specifications, drivers for download, Frequently Asked Questions (FAQ), and E-mail Enquiries are available.

### Toll-Free No. 1800-1069-EPSON(37766)

Our Hotline team can help you with the following over the phone:

- Sales enquiries and product information
- Product usage questions or problems
- Enquiries on repair service and warranty

---

# Software License Terms

---

---

## Open Source Software Licenses

---

### Bonjour

This printer product includes the open source software programs which apply the Apple Public Source License Version 1.2 or its latest version ("Bonjour Programs").

We provide the source code of the Bonjour Programs pursuant to the Apple Public Source License Version 1.2 or its latest version until five (5) years after the discontinuation of same model of this printer product. If you desire to receive the source code of the Bonjour Programs, please see the "Contacting Customer Support" in Appendix or Printing Guide of this User's Guide, and contact the customer support of your region.

You can redistribute Bonjour Programs and/or modify it under the terms of the Apple Public Source License Version 1.2 or its latest version.

These Bonjour Programs are WITHOUT ANY WARRANTY; without even the implied warranty of MERCHANTABILITY AND FITNESS FOR A PARTICULAR PURPOSE.

The Apple Public Source License Version 1.2 is as follows. You also can see the Apple Public Source License Version 1.2 at <http://www.opensource.apple.com/apsl/>.

APPLE PUBLIC SOURCE LICENSE  
Version 2.0 - August 6, 2003

1. General; Definitions. This License applies to any program or other work which Apple Computer, Inc. ("Apple") makes publicly available and which contains a notice placed by Apple identifying such program or work as "Original Code" and stating that it is subject to the terms of this Apple Public Source License version 2.0 ("License"). As used in this License:

1.1 "Applicable Patent Rights" mean: (a) in the case where Apple is the grantor of rights, (i) claims of patents that are now or hereafter acquired, owned by or assigned to Apple and (ii) that cover subject matter contained in the Original Code, but only to the extent necessary to use, reproduce and/or distribute the Original Code without infringement; and (b) in the case where You are the grantor of rights, (i) claims of patents that are now or hereafter acquired, owned by or assigned to You and (ii) that cover subject matter in Your Modifications, taken alone or in combination with Original Code.

1.2 "Contributor" means any person or entity that creates or contributes to the creation of Modifications.

1.3 "Covered Code" means the Original Code, Modifications, the combination of Original Code and any Modifications, and/or any respective portions thereof.

1.4 "Externally Deploy" means: (a) to sublicense, distribute or otherwise make Covered Code available, directly or indirectly, to anyone other than You; and/or (b) to use Covered Code, alone or as part of a Larger Work, in any way to provide a service, including but not limited to delivery of content, through electronic communication with a client other than You.

1.5 "Larger Work" means a work which combines Covered Code or portions thereof with code not governed by the terms of this License.

## Software License Terms

1.6 "Modifications" mean any addition to, deletion from, and/or change to, the substance and/or structure of the Original Code, any previous Modifications, the combination of Original Code and any previous Modifications, and/or any respective portions thereof. When code is released as a series of files, a Modification is: (a) any addition to or deletion from the contents of a file containing Covered Code; and/or (b) any new file or other representation of computer program statements that contains any part of Covered Code.

1.7 "Original Code" means (a) the Source Code of a program or other work as originally made available by Apple under this License, including the Source Code of any updates or upgrades to such programs or works made available by Apple under this License, and that has been expressly identified by Apple as such in the header file(s) of such work; and (b) the object code compiled from such Source Code and originally made available by Apple under this License

1.8 "Source Code" means the human readable form of a program or other work that is suitable for making modifications to it, including all modules it contains, plus any associated interface definition files, scripts used to control compilation and installation of an executable (object code).

1.9 "You" or "Your" means an individual or a legal entity exercising rights under this License. For legal entities, "You" or "Your" includes any entity which controls, is controlled by, or is under common control with, You, where "control" means (a) the power, direct or indirect, to cause the direction or management of such entity, whether by contract or otherwise, or (b) ownership of fifty percent (50%) or more of the outstanding shares or beneficial ownership of such entity.

2. Permitted Uses; Conditions & Restrictions. Subject to the terms and conditions of this License, Apple hereby grants You, effective on the date You accept this License and download the Original Code, a world-wide, royalty-free, non-exclusive license, to the extent of Apple's Applicable Patent Rights and copyrights covering the Original Code, to do the following:

2.1 Unmodified Code. You may use, reproduce, display, perform, internally distribute within Your organization, and Externally Deploy verbatim, unmodified copies of the Original Code, for commercial or non-commercial purposes, provided that in each instance:

(a) You must retain and reproduce in all copies of Original Code the copyright and other proprietary notices and disclaimers of Apple as they appear in the Original Code, and keep intact all notices in the Original Code that refer to this License; and

(b) You must include a copy of this License with every copy of Source Code of Covered Code and documentation You distribute or Externally Deploy, and You may not offer or impose any terms on such Source Code that alter or restrict this License or the recipients' rights hereunder, except as permitted under Section 6.

2.2 Modified Code. You may modify Covered Code and use, reproduce, display, perform, internally distribute within Your organization, and Externally Deploy Your Modifications and Covered Code, for commercial or non-commercial purposes, provided that in each instance You also meet all of these conditions:

(a) You must satisfy all the conditions of Section 2.1 with respect to the Source Code of the Covered Code;

(b) You must duplicate, to the extent it does not already exist, the notice in Exhibit A in each file of the Source Code of all Your Modifications, and cause the modified files to carry prominent notices stating that You changed the files and the date of any change; and

(c) If You Externally Deploy Your Modifications, You must make Source Code of all Your Externally Deployed Modifications either available to those to whom You have Externally Deployed Your Modifications, or publicly available. Source Code of Your Externally Deployed Modifications must be released under the terms set forth in this License, including the license grants set forth in Section 3 below, for as long as you Externally Deploy the Covered Code or twelve (12) months from the date of initial External Deployment, whichever is longer. You should preferably distribute the Source Code of Your Externally Deployed Modifications electronically (e.g. download from a web site).

## Software License Terms

2.3 Distribution of Executable Versions. In addition, if You Externally Deploy Covered Code (Original Code and/or Modifications) in object code, executable form only, You must include a prominent notice, in the code itself as well as in related documentation, stating that Source Code of the Covered Code is available under the terms of this License with information on how and where to obtain such Source Code.

2.4 Third Party Rights. You expressly acknowledge and agree that although Apple and each Contributor grants the licenses to their respective portions of the Covered Code set forth herein, no assurances are provided by Apple or any Contributor that the Covered Code does not infringe the patent or other intellectual property rights of any other entity. Apple and each Contributor disclaim any liability to You for claims brought by any other entity based on infringement of intellectual property rights or otherwise. As a condition to exercising the rights and licenses granted hereunder, You hereby assume sole responsibility to secure any other intellectual property rights needed, if any. For example, if a third party patent license is required to allow You to distribute the Covered Code, it is Your responsibility to acquire that license before distributing the Covered Code.

3. Your Grants. In consideration of, and as a condition to, the licenses granted to You under this License, You hereby grant to any person or entity receiving or distributing Covered Code under this License a non-exclusive, royalty-free, perpetual, irrevocable license, under Your Applicable Patent Rights and other intellectual property rights (other than patent) owned or controlled by You, to use, reproduce, display, perform, modify, sublicense, distribute and Externally Deploy Your Modifications of the same scope and extent as Apple's licenses under Sections 2.1 and 2.2 above.

4. Larger Works. You may create a Larger Work by combining Covered Code with other code not governed by the terms of this License and distribute the Larger Work as a single product. In each such instance, You must make sure the requirements of this License are fulfilled for the Covered Code or any portion thereof.

5. Limitations on Patent License. Except as expressly stated in Section 2, no other patent rights, express or implied, are granted by Apple herein. Modifications and/or Larger Works may require additional patent licenses from Apple which Apple may grant in its sole discretion.

6. Additional Terms. You may choose to offer, and to charge a fee for, warranty, support, indemnity or liability obligations and/or other rights consistent with the scope of the license granted herein ("Additional Terms") to one or more recipients of Covered Code. However, You may do so only on Your own behalf and as Your sole responsibility, and not on behalf of Apple or any Contributor. You must obtain the recipient's agreement that any such Additional Terms are offered by You alone, and You hereby agree to indemnify, defend and hold Apple and every Contributor harmless for any liability incurred by or claims asserted against Apple or such Contributor by reason of any such Additional Terms.

7. Versions of the License. Apple may publish revised and/or new versions of this License from time to time. Each version will be given a distinguishing version number. Once Original Code has been published under a particular version of this License, You may continue to use it under the terms of that version. You may also choose to use such Original Code under the terms of any subsequent version of this License published by Apple. No one other than Apple has the right to modify the terms applicable to Covered Code created under this License.

## Software License Terms

8. NO WARRANTY OR SUPPORT. The Covered Code may contain in whole or in part pre-release, untested, or not fully tested works. The Covered Code may contain errors that could cause failures or loss of data, and may be incomplete or contain inaccuracies. You expressly acknowledge and agree that use of the Covered Code, or any portion thereof, is at Your sole and entire risk. THE COVERED CODE IS PROVIDED "AS IS" AND WITHOUT WARRANTY, UPGRADES OR SUPPORT OF ANY KIND AND APPLE AND APPLE'S LICENSOR(S) (COLLECTIVELY REFERRED TO AS "APPLE" FOR THE PURPOSES OF SECTIONS 8 AND 9) AND ALL CONTRIBUTORS EXPRESSLY DISCLAIM ALL WARRANTIES AND/OR CONDITIONS, EXPRESS OR IMPLIED, INCLUDING, BUT NOT LIMITED TO, THE IMPLIED WARRANTIES AND/OR CONDITIONS OF MERCHANTABILITY, OF SATISFACTORY QUALITY, OF FITNESS FOR A PARTICULAR PURPOSE, OF ACCURACY, OF QUIET ENJOYMENT, AND NONINFRINGEMENT OF THIRD PARTY RIGHTS. APPLE AND EACH CONTRIBUTOR DOES NOT WARRANT AGAINST INTERFERENCE WITH YOUR ENJOYMENT OF THE COVERED CODE, THAT THE FUNCTIONS CONTAINED IN THE COVERED CODE WILL MEET YOUR REQUIREMENTS, THAT THE OPERATION OF THE COVERED CODE WILL BE UNINTERRUPTED OR ERROR-FREE, OR THAT DEFECTS IN THE COVERED CODE WILL BE CORRECTED. NO ORAL OR WRITTEN INFORMATION OR ADVICE GIVEN BY APPLE, AN APPLE AUTHORIZED REPRESENTATIVE OR ANY CONTRIBUTOR SHALL CREATE A WARRANTY. You acknowledge that the Covered Code is not intended for use in the operation of nuclear facilities, aircraft navigation, communication systems, or air traffic control machines in which case the failure of the Covered Code could lead to death, personal injury, or severe physical or environmental damage.

9. LIMITATION OF LIABILITY. TO THE EXTENT NOT PROHIBITED BY LAW, IN NO EVENT SHALL APPLE OR ANY CONTRIBUTOR BE LIABLE FOR ANY INCIDENTAL, SPECIAL, INDIRECT OR CONSEQUENTIAL DAMAGES ARISING OUT OF OR RELATING TO THIS LICENSE OR YOUR USE OR INABILITY TO USE THE COVERED CODE, OR ANY PORTION THEREOF, WHETHER UNDER A THEORY OF CONTRACT, WARRANTY, TORT (INCLUDING NEGLIGENCE), PRODUCTS LIABILITY OR OTHERWISE, EVEN IF APPLE OR SUCH CONTRIBUTOR HAS BEEN ADVISED OF THE POSSIBILITY OF SUCH DAMAGES AND NOTWITHSTANDING THE FAILURE OF ESSENTIAL PURPOSE OF ANY REMEDY. SOME JURISDICTIONS DO NOT ALLOW THE LIMITATION OF LIABILITY OF INCIDENTAL OR CONSEQUENTIAL DAMAGES, SO THIS LIMITATION MAY NOT APPLY TO YOU. In no event shall Apple's total liability to You for all damages (other than as may be required by applicable law) under this License exceed the amount of fifty dollars (\$50.00).

10. Trademarks. This License does not grant any rights to use the trademarks or trade names "Apple", "Apple Computer", "Mac", "Mac OS", "QuickTime", "QuickTime Streaming Server" or any other trademarks, service marks, logos or trade names belonging to Apple (collectively "Apple Marks") or to any trademark, service mark, logo or trade name belonging to any Contributor. You agree not to use any Apple Marks in or as part of the name of products derived from the Original Code or to endorse or promote products derived from the Original Code other than as expressly permitted by and in strict compliance at all times with Apple's third party trademark usage guidelines which are posted at <http://www.apple.com/legal/guidelinesfor3rdparties.html>.

11. Ownership. Subject to the licenses granted under this License, each Contributor retains all rights, title and interest in and to any Modifications made by such Contributor. Apple retains all rights, title and interest in and to the Original Code and any Modifications made by or on behalf of Apple ("Apple Modifications"), and such Apple Modifications will not be automatically subject to this License. Apple may, at its sole discretion, choose to license such Apple Modifications under this License, or on different terms from those contained in this License or may choose not to license them at all.

12. Termination.

12.1 Termination. This License and the rights granted hereunder will terminate:

(a) automatically without notice from Apple if You fail to comply with any term(s) of this License and fail to cure such breach within 30 days of becoming aware of such breach;

(b) immediately in the event of the circumstances described in Section 13.5(b); or

## Software License Terms

(c) automatically without notice from Apple if You, at any time during the term of this License, commence an action for patent infringement against Apple; provided that Apple did not first commence an action for patent infringement against You in that instance.

12.2 Effect of Termination. Upon termination, You agree to immediately stop any further use, reproduction, modification, sublicensing and distribution of the Covered Code. All sublicenses to the Covered Code which have been properly granted prior to termination shall survive any termination of this License. Provisions which, by their nature, should remain in effect beyond the termination of this License shall survive, including but not limited to Sections 3, 5, 8, 9, 10, 11, 12.2 and 13. No party will be liable to any other for compensation, indemnity or damages of any sort solely as a result of terminating this License in accordance with its terms, and termination of this License will be without prejudice to any other right or remedy of any party.

### 13. Miscellaneous.

13.1 Government End Users. The Covered Code is a "commercial item" as defined in FAR 2.101. Government software and technical data rights in the Covered Code include only those rights customarily provided to the public as defined in this License. This customary commercial license in technical data and software is provided in accordance with FAR 12.211 (Technical Data) and 12.212 (Computer Software) and, for Department of Defense purchases, DFAR 252.227-7015 (Technical Data -- Commercial Items) and 227.7202-3 (Rights in Commercial Computer Software or Computer Software Documentation). Accordingly, all U.S. Government End Users acquire Covered Code with only those rights set forth herein.

13.2 Relationship of Parties. This License will not be construed as creating an agency, partnership, joint venture or any other form of legal association between or among You, Apple or any Contributor, and You will not represent to the contrary, whether expressly, by implication, appearance or otherwise.

13.3 Independent Development. Nothing in this License will impair Apple's right to acquire, license, develop, have others develop for it, market and/or distribute technology or products that perform the same or similar functions as, or otherwise compete with, Modifications, Larger Works, technology or products that You may develop, produce, market or distribute.

13.4 Waiver; Construction. Failure by Apple or any Contributor to enforce any provision of this License will not be deemed a waiver of future enforcement of that or any other provision. Any law or regulation which provides that the language of a contract shall be construed against the drafter will not apply to this License.

13.5 Severability. (a) If for any reason a court of competent jurisdiction finds any provision of this License, or portion thereof, to be unenforceable, that provision of the License will be enforced to the maximum extent permissible so as to effect the economic benefits and intent of the parties, and the remainder of this License will continue in full force and effect. (b) Notwithstanding the foregoing, if applicable law prohibits or restricts You from fully and/or specifically complying with Sections 2 and/or 3 or prevents the enforceability of either of those Sections, this License will immediately terminate and You must immediately discontinue any use of the Covered Code and destroy all copies of it that are in your possession or control.

13.6 Dispute Resolution. Any litigation or other dispute resolution between You and Apple relating to this License shall take place in the Northern District of California, and You and Apple hereby consent to the personal jurisdiction of, and venue in, the state and federal courts within that District with respect to this License. The application of the United Nations Convention on Contracts for the International Sale of Goods is expressly excluded.

13.7 Entire Agreement; Governing Law. This License constitutes the entire agreement between the parties with respect to the subject matter hereof. This License shall be governed by the laws of the United States and the State of California, except that body of California law concerning conflicts of law.

Where You are located in the province of Quebec, Canada, the following clause applies: The parties hereby confirm that they have requested that this License and all related documents be drafted in English. Les parties ont exigé que le présent contrat et tous les documents connexes soient rédigés en anglais.

## Software License Terms

### EXHIBIT A.

"Portions Copyright (c) 1999-2003 Apple Computer, Inc. All Rights Reserved.

This file contains Original Code and/or Modifications of Original Code as defined in and that are subject to the Apple Public Source License Version 2.0 (the 'License'). You may not use this file except in compliance with the License. Please obtain a copy of the License at <http://www.opensource.apple.com/apsl/> and read it before using this file.

The Original Code and all software distributed under the License are distributed on an 'AS IS' basis, WITHOUT WARRANTY OF ANY KIND, EITHER EXPRESS OR IMPLIED, AND APPLE HEREBY DISCLAIMS ALL SUCH WARRANTIES, INCLUDING WITHOUT LIMITATION, ANY WARRANTIES OF MERCHANTABILITY, FITNESS FOR A PARTICULAR PURPOSE, QUIET ENJOYMENT OR NON-INFRINGEMENT. Please see the License for the specific language governing rights and limitations under the License."

## Other Software Licenses

---

### Info-ZIP copyright and license

This is version 2007-Mar-4 of the Info-ZIP license. The definitive version of this document should be available at <ftp://ftp.info-zip.org/pub/infozip/license.html> indefinitely and a copy at <http://www.info-zip.org/pub/infozip/license.html>.

Copyright © 1990-2007 Info-ZIP. All rights reserved.

For the purposes of this copyright and license, "Info-ZIP" is defined as the following set of individuals:

Mark Adler, John Bush, Karl Davis, Harald Denker, Jean-Michel Dubois, Jean-loup Gailly, Hunter Goatley, Ed Gordon, Ian Gorman, Chris Herborth, Dirk Haase, Greg Hartwig, Robert Heath, Jonathan Hudson, Paul Kienitz, David Kirschbaum, Johnny Lee, Onno van der Linden, Igor Mandrichenko, Steve P. Miller, Sergio Monesi, Keith Owens, George Petrov, Greg Roelofs, Kai Uwe Rommel, Steve Salisbury, Dave Smith, Steven M. Schweda, Christian Spieler, Cosmin Truta, Antoine Verheijen, Paul von Behren, Rich Wales, Mike White.

Permission is granted to anyone to use this software for any purpose, including commercial applications, and to alter it and redistribute it freely, subject to the above disclaimer and the following restrictions:

1. Redistributions of source code (in whole or in part) must retain the above copyright notice, definition, disclaimer, and this list of conditions.
2. Redistributions in binary form (compiled executables and libraries) must reproduce the above copyright notice, definition, disclaimer, and this list of conditions in documentation and/or other materials provided with the distribution. The sole exception to this condition is redistribution of a standard UnZipSFX binary (including SFXWiz) as part of a self-extracting archive; that is permitted without inclusion of this license, as long as the normal SFX banner has not been removed from the binary or disabled.



## Software License Terms

3. Altered versions--including, but not limited to, ports to new operating systems, existing ports with new graphical interfaces, versions with modified or added functionality, and dynamic, shared, or static library versions not from Info-ZIP--must be plainly marked as such and must not be misrepresented as being the original source or, if binaries, compiled from the original source. Such altered versions also must not be misrepresented as being Info-ZIP releases--including, but not limited to, labeling of the altered versions with the names "Info-ZIP" (or any variation thereof, including, but not limited to, different capitalizations), "Pocket UnZip," "WiZ" or "MacZip" without the explicit permission of Info-ZIP. Such altered versions are further prohibited from misrepresentative use of the Zip-Bugs or Info-ZIP e-mail addresses or the Info-ZIP URL(s), such as to imply Info-ZIP will provide support for the altered versions.
4. Info-ZIP retains the right to use the names "Info-ZIP," "Zip," "UnZip," "UnZipSFX," "WiZ," "Pocket UnZip," "Pocket Zip," and "MacZip" for its own source and binary releases.