

Register your product and get support at

www.philips.com/welcome

32HFL5573D/10

40HFL5573D/10

46HFL5573D/10

55HFL5573D/10



EN User Manual

PHILIPS

Contents

1. Notice	3	Welcome Logo / Hotel Information	44
2. Important	5	RF Download	44
		Start Download	45
3. Get started	8	7. Connect your TV	46
TV tour	8	About cables	46
Connect devices	9	Connect devices	48
4. Use your TV	12	Connect more devices	55
Controls	12	Computers and the Internet	56
Watch TV	14	Wireless LAN ready	57
Browse Net TV	18	Common interface	59
5. Use more of your TV	20	8. Troubleshooting	60
View Teletext	20	Contact Philips	60
Set clocks and timers	21	General TV	60
View subtitles	22	TV channel	61
View Hotel Information	22	Picture	61
Use EasyLink	23	Sound	62
6. Set up your TV	25	HDMI	62
Introduction	25	USB	63
Benefits of specific Hotel TVs	25	Network	63
Professional Setup Remote control (22AV8573 optional)	25	9. Product specifications	64
Professional mode options	26	Power and reception	64
Setup settings	28	Display and sound	64
PBS Setup	28	Display resolutions	65
TV Setup	35	Multimedia	66
Change picture and sound settings (with PBS setup RC)	35	Connectivity	67
More Channel Settings	40	Dimensions	67
Change channel settings	43	Use a Kensington lock	69
Source Selection	43	10. Index	70
Store Settings	43		
Smart Clone	43		

1. Notice

2010 © Koninklijke Philips Electronics N.V. All rights reserved.

Specifications are subject to change without notice. Trademarks are the property of Koninklijke Philips Electronics N.V or their respective owners. Philips reserves the right to change products at any time without being obliged to adjust earlier supplies accordingly. The material in this manual is believed adequate for the intended use of the system. If the product, or its individual modules or procedures, are used for purposes other than those specified herein, confirmation of their validity and suitability must be obtained. Philips warrants that the material itself does not infringe any United States patents. No further warranty is expressed or implied.

Warranty

- Risk of injury, damage to TV or void of warranty! Never attempt to repair the TV yourself.
- Use the TV and accessories only as intended by the manufacturer.
- The caution sign printed on the back of the TV indicates risk of electric shock. Never remove the TV cover. Always contact Philips Customer Support for service or repairs.



Any operation expressly prohibited in this manual, or any adjustments and assembly procedures not recommended or authorised in this manual shall void the warranty.

Pixel characteristics

This LCD product has a high number of colour pixels. Although it has effective pixels of 99.999% or more, black dots or bright points of light (red, green or blue) may appear constantly on the screen. This is a structural property of the display (within common industry standards) and is not a malfunction.

Open source software

This television contains open source software. Philips hereby offers to deliver or make available, upon request, for a charge no more than the cost of physically performing source distribution, a complete machine-readable copy of the corresponding source code on a medium customarily used for software interchange. This offer is valid for a period of 3 years after the date of purchase of this product. To obtain the source code, write to:

GBU Customer Care Manager
Customer Care department
Philips Lighting
GBU Hospitality
Hurksestraat 2c
5652 AJ Eindhoven
The Netherlands

Compliance with EMF

Koninklijke Philips Electronics N.V. manufactures and sells many products targeted at consumers which, like any electronic apparatus, in general have the ability to emit and receive electromagnetic signals.

One of Philips' leading Business Principles is to take all necessary health and safety measures for our products, to comply with all applicable legal requirements and to stay well within the EMF standards applicable at the time of producing the products.

Philips is committed to develop, produce and market products that cause no adverse health effects. Philips confirms that if its products are handled properly for their intended use, they are safe to use according to scientific evidence available today.

Philips plays an active role in the development of international EMF and safety standards, enabling Philips to anticipate further developments in standardisation for early integration in its products.

Mains fuse (UK only)

This TV is fitted with an approved molded plug. Should it become necessary to replace the mains fuse, this must be replaced with a fuse of the same value as indicated on the plug (example 10A).

- 1 Remove fuse cover and fuse.
2. The replacement fuse must comply with BS 1362 and have the ASTA approval mark. If the fuse is lost, contact your dealer in order to verify the correct type.

3. Refit the fuse cover.
In order to maintain conformity to the EMC directive, the mains plug on this product must not be detached from the mains cord cable.

Copyright



VESA, FDMI and the VESA Mounting Compliant logo are trademarks of the Video Electronics Standards Association. ® Kensington and Micro Saver are registered US trademarks of ACCO World Corporation with issued registrations and pending applications in other countries throughout the world.



Manufactured under license from Dolby Laboratories. Dolby and the double-D symbol are trademarks of Dolby Laboratories.

All other registered and unregistered trademarks are the property of their respective owners

2. Important

Read and understand all instructions before you use your TV. If damage is caused by failure to follow instructions, the warranty does not apply.

Safety

- **Risk of electric shock or fire!**

- Never expose the TV to rain or water. Never place liquid containers, such as vases, near the TV. If liquids are spilt on or into the TV, disconnect the TV from the power outlet immediately. Contact Philips Consumer Care to have the TV checked before use.

- Never place the TV, remote control or batteries near naked flames or other heat sources, including direct sunlight.

To prevent the spread of fire, keep candles or other flames away from the TV, remote control and batteries at all times.



- Never insert objects into the ventilation slots or other openings on the TV.
- When the TV is swiveled ensure that no strain is exerted on the power cord. Strain on the power cord can loosen connections and cause arcing.

- **Risk of short circuit or fire!**

- Never expose the remote control or batteries to rain, water or excessive heat.
- Avoid force coming onto power plugs. Loose power plugs can cause arcing or fire.

- **Risk of injury or damage to the TV!**

- Two people are required to lift and carry a TV that weighs more than 25 kg.
- When stand mounting the TV, use only the supplied stand. Secure the stand to the TV tightly. Place the TV on a flat, level surface that can support the combined weight of the TV and the stand.
- When wall mounting the TV, use only a wall mount that can support the weight of the TV. Secure the wall mount to a wall that can support the combined weight of the TV and wall mount. Koninklijke Philips Electronics N.V. bears no responsibility for improper wall mounting that result in accident, injury or damage.

- **Risk of injury to children! Follow these** precautions to prevent the TV from toppling over and causing injury to children:
 - Never place the TV on a surface covered by a cloth or other material that can be pulled away.
 - Ensure that no part of the TV hangs over the edge of the surface.
 - Never place the TV on tall furniture (such as a bookcase) without anchoring both the furniture and TV to the wall or a suitable support.
 - Educate children about the dangers of climbing on furniture to reach the TV.
- **Risk of overheating! Never install the TV** in a confined space. Always leave a space of at least 4 inches or 10 cm around the TV for ventilation. Ensure curtains or other objects never cover the ventilation slots on the TV.
- **Risk of damage to the TV! Before you** connect the TV to the power outlet, ensure that the power voltage matches the value printed on the back of the TV. Never connect the TV to the power outlet if the voltage is different
- **Risk of injury, fire or power cord damage!** Never place the TV or any objects on the power cord.
- **To easily disconnect the TV power cord from** the power outlet, ensure that you have full access to the power cord at all times.
- **When you disconnect the power cord,** always pull the plug, never the cable.
- **Disconnect the TV from the power outlet and** aerial before lightning storms. During lightning storms, never touch any part of the TV, power cord or aerial cable.
- **Risk of hearing damage! Avoid using** earphones or headphones at high volumes or for prolonged periods of time.
- **If the TV is transported in temperatures** below 5°C, unpack the TV and wait until the TV temperature matches room temperature before connecting the TV to the power outlet.

Screen care

- Avoid stationary images as much as possible. Stationary images are images that remain on-screen for extended periods of time. Examples include: on-screen menus, black bars and time displays. If you must use stationary images, reduce screen contrast and brightness to avoid screen damage.
- Unplug the TV before cleaning.
- Clean the TV and frame with a soft, damp cloth. Never use substances such as alcohol, chemicals or household cleaners on the TV.
- Risk of damage to the TV screen! Never touch, push, rub or strike the screen with any object.
- To avoid deformations and colour fading, wipe off water drops as soon as possible

Disposal of your old product and batteries



Your product is designed and manufactured with high quality materials and components, which can be recycled and reused.



When this crossed-out wheeled bin symbol is attached to a product it means that the product is covered by the European Directive 2002/96/EC. Please inform yourself about the local separate collection system for electrical and electronic products. Please act according to your local rules and do not dispose of your old products with your normal household waste. Correct disposal of your old product helps to prevent potential negative consequences for the environment and human health.



Your product contains batteries covered by the European Directive 2006/66/EC, which cannot be disposed with normal household waste. Please inform yourself about the local rules on separate collection of batteries because correct disposal helps to prevent negative consequences for the environmental and human health.

Ecolabel

Philips continuously focuses on lowering the environmental impact of our innovative products. We aim our efforts towards environmental improvements during manufacturing, reduction of harmful substances, efficient use of energy, end-of-life instructions and product packaging.

This TV has been awarded the European Union Ecolabel for its environmentally friendly qualities.

A TV that is awarded the Ecolabel contains energy-efficient features. To access energysaving settings while you watch TV, press the **Green button** on the remote control.



You can find detailed information on standby energy consumption, warranty policy, spare parts and recycling of this TV on the Philips website for your country at www.philips.com.

3. Get started

TV tour

Remote control

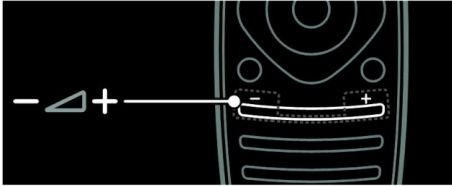

To adjust the volume.

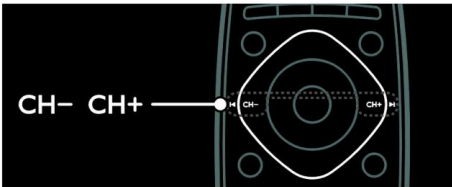

To switch TV channels.



To open or close the Home menu

In the Home menu, access connected devices, picture and sound settings, and other useful features.



To open or close the Source menu

In the Source menu, access connected devices.

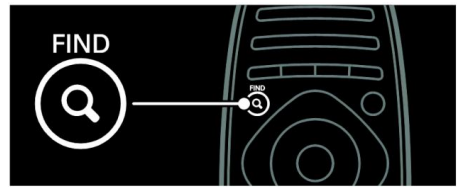

To open or close the Find menu

In the Find menu, access the channel list.

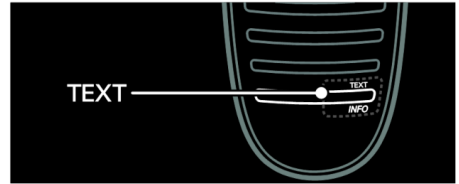

To open or close the Text menu

In the Text menu, access teletext for news and information.



To open or close the Options menu

Options menus offer convenient settings for TV channel or program.



To return to the previous menu page or to exit from a TV function.

Press and hold to return to watching TV.

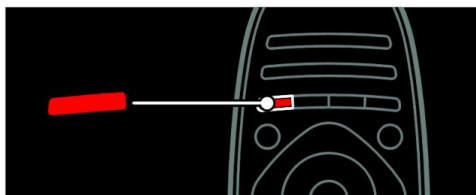

To select a red menu option, access digital Interactive TV services*, or watch TV demonstration clips.

*Available on certain models only.

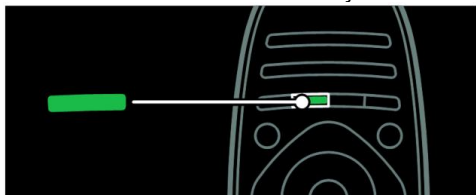

To select a green menu option or to access energy efficient settings.

Read more about the remote control in **Use your TV > Controls > Remote control** (Page 10).

Press **▲** to select the next TV tour.

Connect devices

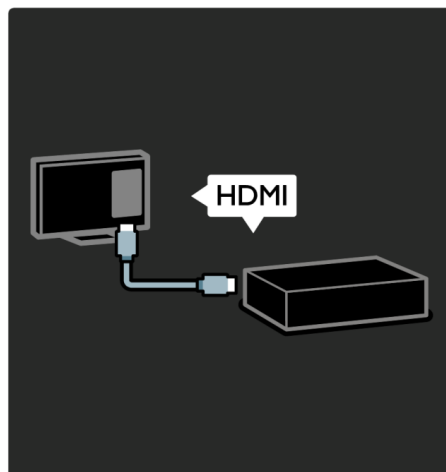

For the best picture and sound quality, connect a DVD, Blu-ray disc player, or game console through HDMI (TM).

To watch a non EasyLink compliant device, add it to the Home menu.

1. Press **🏠** > **[Add your devices]**
2. Follow the onscreen instructions.

Note: If you are prompted to select the TV connection, select the connector that this device uses. See **Connect your TV > Connect devices** (Page 37) for information on connection.

If an EasyLink or HDMI-Consumer Electronic Control (HDMI-CEC) compliant device is connected to the TV, it is automatically added to the Home menu when both devices are switched on.

To watch a connected device

1. Press **🏠**
2. Select the newly added device icon.

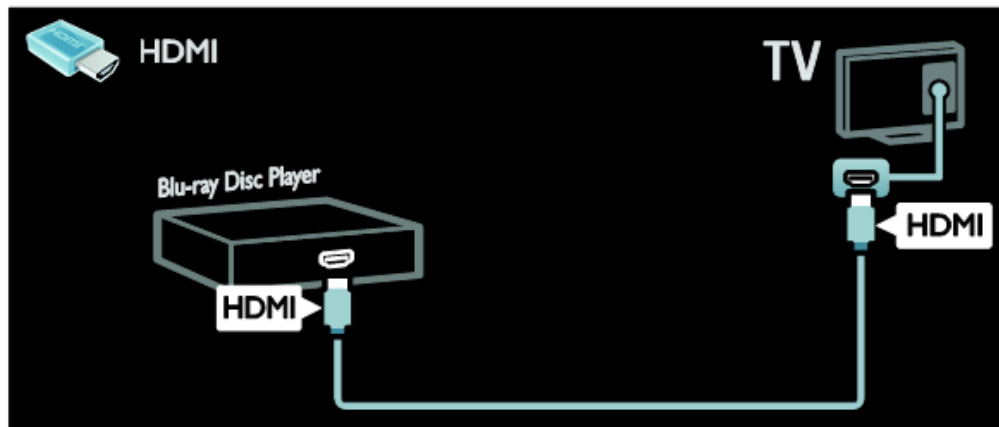

High Definition TV

For high-definition (HD) picture quality, watch HD programs

On standard-definition (SD) programs, the picture quality is standard.

You can watch HD video content in these ways and more:

- a Blu-ray disc player, connected with a HDMI cable, playing a Blu-ray disc
- an upscaling DVD player, connected with a HDMI cable, playing a DVD disc
- an over-the-air HD broadcaster (DVB-MPEG4)
- a digital HD receiver, connected with an HDMI cable, playing HD content from a cable or satellite operator
- a HD channel on your DVB-C network
- a HD game console (for example X-Box 360 or PlayStation 3), connected with an HDMI cable, playing a HD game

HD video clip

To experience the stunning sharpness and picture quality of HD TV, watch the HD video clip from the Home menu.

Press **⬆** >[Setup] > [Watch demos].

Watch Demo is on the second page of the setup menu

For more information about the availability of HD channels in your country, contact your Philips dealer or visit www.philips.com/support

Network

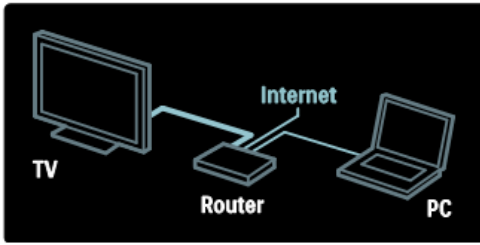

Connect your TV to your home network to play music, photos, and videos from a computer or other media server on the same network.

Read more in **Connect your TV > Computers and the Internet** (Page 44).

Net TV

If your home network is connected to the Internet, you can connect your TV to **Net TV**. Net TV offers movies, pictures, music, and much more.

Read more in **Use your TV > Browse Net TV** (Page 15).

4. Use your TV

Controls

TV controls

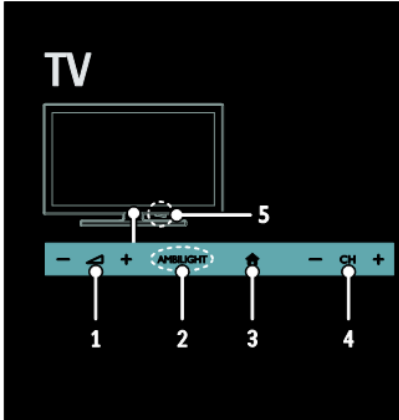

1. **▲+/-**: Increase or decrease volume.
2. *N.A.*
3. **🏠 (Home)**: Access the Home menu. Press again to launch an activity in the Home menu.
4. **CH +/-**: Switch to the next or previous channel.

Indicators

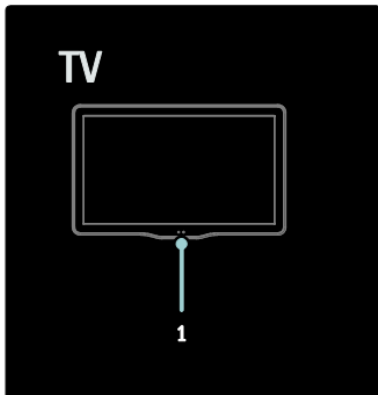

1. Ambient sensor / remote control sensor

Ambient sensor is available on certain models only.

Remote control

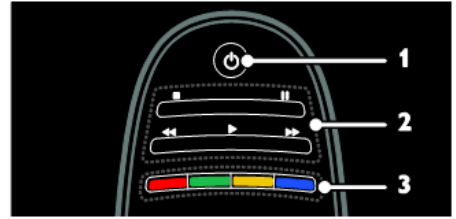

1. **(Standby)**: Switch the TV on or to standby.
2. **Play buttons**: Control video or music play.
3. **Color buttons**: Select tasks or options.

Not supported in MHEG mode.



4. **(Home)**: Access the Home menu.
5. **(Navigation buttons)**: Navigate through menus and select items.
6. **CH - / CH +** (Previous/Next): Switch channels, navigate through menu pages, tracks, albums, or folders.
7. **OK**: Confirm an entry or selection.
8. **(Back)**: Return to the previous menu page or to exit from a TV function.



9. **FIND**: Access the menu to select TV channel list.
10. **NetTV**: Access the NetTV page.
11. **SOURCE**: Select connected devices.
12. **OPTIONS**: Access options for the current activity or selection.

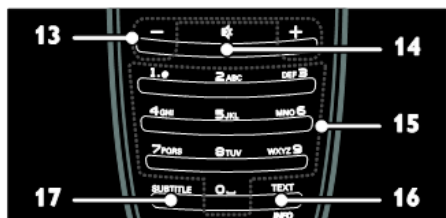

13. **+/- (Volume)**: Adjust volume.
14. **(Mute)**: Mute or restore audio.
15. **0 – 9 (Numeric buttons)**: Select channels.
16. **TEXT/INFO**: Enable or disable teletext.
Press and hold to view more information on the current activity.

The **INFO** button is available on certain models only.
17. **SUBTITLE**: Enable or disable subtitles.

Batteries

Warning: Risk of swallowing batteries!

The product/remote control may contain a coin type battery, which can be swallowed. Keep the battery out of reach of children at all times!

Caution: The battery contains perchlorate material, handle it with care. For information, see www.dtsc.ca.gov/hazardouswaste/perchlorate

If your remote control signal is weak, replace the batteries:

1. Open the battery cover.
2. Remove the old batteries from the battery compartment, and replace them with fresh batteries.

Make sure that the ends of the batteries line up correctly with the +/- markings in the battery compartment.

Notes:

Dispose of batteries according to environmental directives.

Remove batteries from the remote control if you will not use it for an extended period of time.

Remote control with coin cell batteries:

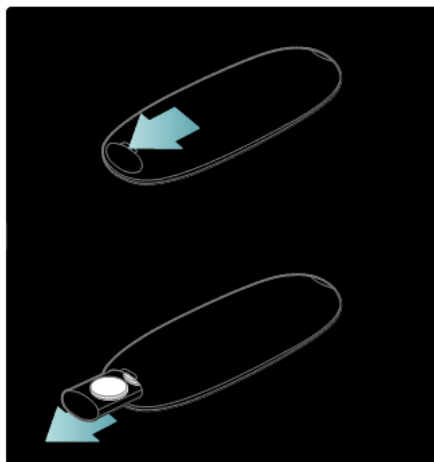

EasyLink controls

Note: EasyLink controls are available when the connected device is HDMI-CEC compliant.

EasyLink allows you to control your TV and other HDMI-CEC devices with one remote control.

Access EasyLink controls

1. While you view content from a connected HDMI-CEC device, press **OPTIONS**.
2. Select **[Show device keys]**, then press **OK**.
3. Select the EasyLink control button, then press **OK**.

Read more on EasyLink in **Use more of your TV > Use EasyLink** (Page 18).

Watch TV

Switch TV on or off

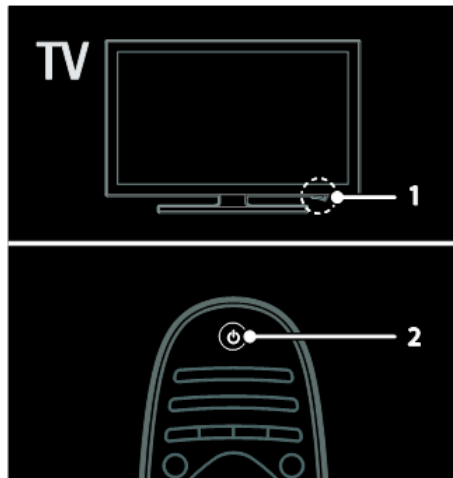

Switch the TV on

- Press the power switch at the base of the TV to the ON position.
- If the TV is in standby, press  on the remote control.

Note: There is a short delay before the TV responds.

Tip: If you cannot find your remote control and want to switch on the TV from standby, press **CH +/-** on the front of the TV.

Switch TV to standby

Press  on the remote control. The remote control sensor on the TV switches to red.

Automatic switch off

This TV is designed with energy efficiency settings. If there is no user interaction (such as pressing a remote control button or a control on the front panel) for four hours, the TV will automatically switch to standby.

To disable automatic switch off,

While you watch TV, press the green button on the remote control. Select **[Auto switch off]** and press OK. An on screen message confirms that automatic switch off is disabled.

Adjust TV volume

Increase or decrease the TV volume

- Press **+/-** on the remote control.
- Press **▲ +/-** on the front of the TV.

Mute or unmute the TV volume

- Press **🔇** to mute the TV, or
- Press **🔇** again to restore the volume.

Switch TV channels

Press **CH+ / CH-** on the remote control.

Press **CH +/-** on the TV.

Press the **Numeric buttons** to enter a channel number.

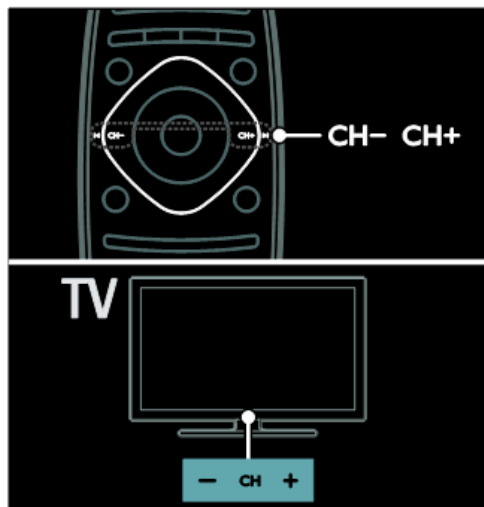

View program guide

The program guide displays information about digital TV channels, for example:

- Channel schedules
- Synopsis of programs

Note: TV program guides are available in certain countries only.

Use smart picture settings

Select your preferred picture setting.

1. While you watch TV, press **≡**
OPTIONS
2. Select **[Smart picture]**.
3. Select one of the following settings, then press **OK**:
 - **[Personal]**: Apply your personalized picture settings.
 - **[Vivid]**: Rich and dynamic settings, ideal for daytime viewing.
 - **[Natural]**: Natural picture settings.
 - **[Cinema]**: Ideal settings for movies.
 - **[Game]**: Ideal settings for games.
 - **[Energy saving]**: Settings that conserve the most energy.
 - **[Standard]**: Default settings that suit most environments and types of video.
 - **[Photo]**: Ideal settings for photos.
 - **[Custom]**: Customize and store your own picture settings.

Use smart sound settings

Select your preferred sound setting.

1. While you watch TV, press 
OPTIONS
2. Select **[Smart sound]**
3. Select one of the following settings, then press **OK**:
 - **[Personal]**: Apply your preferred setting in the Sound menu.
 - **[Standard]**: Settings that suit most environments and types of audio.
 - **[News]**: Ideal settings for spoken audio, such as the news.
 - **[Movie]**: Ideal settings for movies.
 - **[Game]**: Ideal settings for games.
 - **[Drama]**: Ideal settings for drama programs.
 - **[Sports]**: Ideal settings for sports.

Watch a connected device

Add new device

Notes:

- Before you watch a connected device, you must add its icon to the Home menu. **See Connect your TV > Connect device** (Page 37).
- If you connect an HDMI-CEC compliant device to the TV through HDMI connector and switch it on, the device is automatically added to the Home menu.

1. Connect and switch on the device.
2. Press .
3. Select **[Add your devices]**, then press **OK**.
4. Follow the onscreen instructions.
 - Select your device.
 - Select the connector.

Note: If you are prompted to select the TV connection, select the connector that this device uses.

Select a source

From Home menu

After you have added the new device to the Home menu, select the new device icon to view its contents.

1. Press .
2. Select the device icon from the Home menu.
3. Press **OK** to confirm.

From Source menu

You can also press  **SOURCE** to display a list of connector names. Select the connector that connects the device to the TV.

1. Press  **SOURCE**.
2. Press the **Navigation buttons** to select a connector in the list.
3. Press **OK** to confirm.

Play from USB

If you have photos, videos or music files on a USB storage device, you can play the files on TV.

Caution: Philips is not responsible if the USB storage device is not supported, nor is it responsible for damage or loss of data in the device.

Do not overload the USB port. If you connect a HDD device that consumes more than 500mA power, make sure that it is connected to its own external power supply.

Access the USB content browser as follows:

While you watch TV, connect the USB device to the USB connector on the TV.

Press , select **[Browse USB]**, then press **OK**.

Watch video

Press the **Navigation buttons** to select a video file, then press **OK**.

- Press **◀** or **▶** to search forward or backward within a video.
- Press and hold  to exit the content browser.

While you play video, press  **OPTIONS** to access the following video options:

- **[Stop]:** Stop playback.
- **[Repeat]:** Repeat a video.
- **[Shuffle on] / [Shuffle off]:** Enable or disable random play of videos.

Listen to music

Press the **Navigation buttons** to select a music track, then press **OK**.

Press **◀◀ / ▶▶** to search forward or backward within a track.

Press and hold  to exit content browser.

Press  **OPTIONS** to access or exit the following music options:

- **[Stop]:** Stop audio play.
- **[Repeat]:** Repeat a track or an album.
- **[Play once]:** Play the track once.
- **[Shuffle on] / [Shuffle off]:** Enable or disable random play of tracks.

View picture

Press the **Navigation buttons** to select a picture, then press **OK**.

- To pause or stop play, press **OK**.
- To skip to the previous or next file, press **|◀** or **▶|**

Press and hold  to exit content browser.

Press  **OPTIONS** to access or exit the following picture options:

- **[Show info]**: Display the file information.
- **[Stop]**: Stop slideshow.
- **[Rotate]**: Rotate the file.
- **[Repeat]**: Repeat the slideshow.
- **[Play once]**: Play the file once.
- **[Shuffle off] / [Shuffle on]**: Enable or disable random display of pictures in the slideshow.
- **[Slideshow speed]**: Set the display time for each picture in the slideshow.
- **[Slideshow transition]**: Set the transition from one picture to the next.
- **[Set as Scenea]**: Set the selected picture as wallpaper on TV.

Browse Net TV

What you can do

Enjoy Internet Applications (Apps), specially adapted internet websites for your TV. You can control the Apps with the TV remote control. For example, you can:

- Read newspaper headlines
- Watch videos
- Check weather forecasts

Use the catch-up TV feature to watch TV programs that you missed. Availability of catch-up TV Apps differ for each country. To find out which TV programs are available, access the Net TV program guide.

Notes:

- Each country has different Net TV services.
- Certain websites may not display completely. Some functions are not available, for example file download, or functions that require plug-ins.
- Net TV services are updated automatically.
- Net TV displays one page at a time, in full screen.
- Koninklijke Philips Electronics N.V. bears no responsibility regarding the content and the quality of the content provided by the content service providers.

What you need

To enjoy Net TV, complete these tasks:

1. On your home network, connect the TV to the Internet
2. On your TV, configure Net TV.

Connect the TV to the Internet

On your home network, connect the following:

1. Connect a router with a high-speed connection to the Internet.
2. Switch on the router.
3. Install the network. See **Connect the TV > Computers and the Internet** (Page 44).

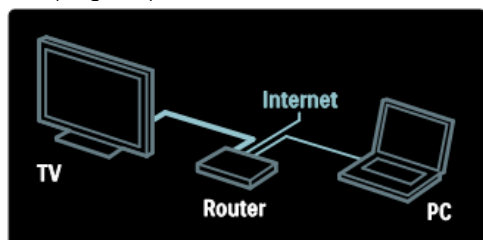

Access Net TV Applications (Apps)

The first page shown is the Net TV home page. The icons on this page represent the different countries and the watch TV application. Within the different country flags there are country dependent applications:

- Browse internet websites with the Internet Apps. Press the **Navigation buttons** to select an App, then press **OK** to confirm.
- Read the Net TV quick guide for more information.

Access website

1. Select an Internet App, then press **OK**.
2. Use the **Numeric buttons** on the TV remote control to enter a web address.

Onscreen keyboard

Select the area to enter the web address, then press **OK**.

A keyboard appears on the screen. Use this to enter a web address.

5. Use more of your TV

View Teletext

Select a page

1. Select a channel that has teletext feature, then press **TEXT**.
2. Select a page in one of the following ways:
Enter the page number with the **Numeric buttons**
Press **▲▼** or **◀▶** to view the next or previous page.
Press the **Color buttons** to select a color coded item.
3. Press  to exit.

Teletext options

1. When you view teletext, press  **OPTIONS**.
2. Select one of the following options:
[Freeze page] / [Unfreeze page]: Freeze or unfreeze the current page.
[Dual screen] / [Full screen]: Enable or disable dual screen teletext. Dual screen splits the current channel or source to the left of the screen, with teletext on the right.
[T.O.P. overview]: Table Of Pages (T.O.P.) teletext broadcasts allow you to jump from one subject to another without using page numbers.
[Enlarge] / [Normal view]: Zoom in the page. Press the Navigation buttons to move around the enlarged view.
[Reveal]: Hide or reveal hidden information on a page, such as solutions to riddles or puzzles.

[Cycle subpages]: If subpages are available, each is shown automatically.

[Language]: Switch to a different language group to display different character sets correctly.

3. Press  **OPTIONS** to exit.

Teletext language

Some digital TV broadcasters provide several teletext languages. You can set your primary and secondary language.

1. Press .
2. Select **[Setup] > [Channel settings]**
3. Select **[Languages] > [Primary Text] or [Secondary Text]**.
4. Select your preferred teletext languages, then press **OK**.

Subpages

A teletext page can contain several subpages. These subpages are shown on a bar next to the main page number. If subpages are available on a teletext page, press **◀** or **▶** to select them.

Search

1. When you view teletext, press **OK** to highlight the first word or number.
2. Press the **Navigation buttons** to skip to the word or number to search.
3. Press **OK** to begin the search.
4. Press **▲** until no word or number is highlighted to exit the search.

Digital teletext

Some digital TV broadcasters offer dedicated digital text or interactive services on their digital TV channels, for example BBC1.

When in digital teletext:

- Press the **Navigation buttons** to select or highlight items.
- Press the **Color buttons** to select an option, then press **OK** to confirm or activate.

Note:

Digital text services are blocked when subtitles are broadcast and enabled on the TV. Read **Use more of your TV > View subtitles** (Page 17).

Teletext 2.5

Teletext 2.5 offers more colors and better graphics than normal teletext. If Teletext 2.5 is broadcast by a channel, it is switched on by default.

To switch Teletext 2.5 on or off

1. Press .
2. Select **[Setup] > [TV settings] > [Preferences]**.
3. Select **[Text 2.5] > [On]** or **[Off]**, then press **OK**.

Set clocks and timers

Clock

You can display a clock on the TV screen. The clock displays the time that is broadcast by your TV service operator.

Display the TV clock

1. While you watch TV, press  **OPTIONS**.
2. Select **[Status]**, then press **OK**.
The clock is displayed on the lower right hand corner of the TV screen.

Change the clock mode

The clock mode is automatically synchronized to the Coordinated Universal Time (UTC). If your TV cannot receive UTC transmissions, change the clock mode to **[Manual]**

View subtitles

Analog channels

1. Switch the TV to an analog TV channel.
2. Press **TEXT**.
3. Enter the three-digit page number of the subtitles page (usually '888').
4. Press  to exit Teletext. Subtitles display if available.

Digital channels

1. Press  **OPTIONS**.
2. Select **[Subtitles]**, then press **OK**.
3. Select **[Subtitles off]**, **[Subtitles on]** or **[On during mute]**, then press **OK**.

Note:

- If MHEG application is activated, subtitles are not displayed.
- If you select **[On during mute]**, subtitles are displayed only when you press  to mute the sound.

Subtitle language

You can change the subtitle language on some digital channels.

1. Press .
2. Select **[Setup] > [Channel settings] > [Subtitle language]**
3. Select **[Primary subtitles]** or **[Secondary subtitles]** for the preferred language.
4. Press **OK** to confirm.

Tip:

You can also press  **OPTIONS > [Subtitle language]**

View Hotel Information

What you can do

You can display a default picture as the wallpaper on your TV. You can also load another picture as the wallpaper.

What you need

To use another picture as the wallpaper, you need a USB storage device that contains a picture that is less than 1 MB in size.

Switch on

1. Press .
2. Select **[Hotel Information]**, then press **OK**.

The default picture is displayed.

Use EasyLink

What you can do

Get the most out of your HDMI-CEC-compliant devices with Philips EasyLink enhanced control features. If your HDMI-CEC compliant devices are connected through HDMI, you can control them at the same time with your TV remote control.

Note: Other brands describe HDMI-CEC functionality differently. Some examples are Anynet (Samsung), Aquos Link (Sharp) or BRAVIA Sync (Sony). Not all brands are fully compatible with Philips EasyLink.

When Philips EasyLink is set, these features are available:

One-touch play

When you play a HDMI-CEC compliant device, the TV switches on from standby, and switches to the correct source.

One-touch standby

When you press on the TV remote control, the TV and all HDMI-CEC compliant devices switch to standby mode.

System audio control

If you connect a HDMI-CEC compliant device that includes speakers, you can choose to hear the TV from those speakers instead of the TV speakers.

For more information about TV audio output, see **Use more of your TV > Use EasyLink > Select speaker output** (Page 19).

EasyLink remote control

You can control multiple HDMI-CEC compliant devices with your TV remote control.

To switch on EasyLink Remote Control, see **Use more of your TV > Use EasyLink > Control devices simultaneously** (Page 19).

Retain picture quality

If your TV picture quality is affected by the picture-processing features of other devices, switch on Pixel Plus Link.

To switch on Pixel Plus Link, see **Use more of your TV > Use EasyLink > Retain picture quality** (Page 18).

Maximize display for subtitled video

While you view subtitles in a video, you can maximize the video display area. Some subtitles can create a separate subtitle bar under the video, which limits the video display area. After you switch on auto subtitle shift, the subtitles display on top of the video image, which maximizes the video display area.

To switch on auto subtitle shift, see **Use more of your TV > Use EasyLink > Maximize display for subtitled video** (Page 18).

Hear another device at standby

You can hear a connected HDMI-CEC compliant device through the TV speakers, even when the TV is in standby.

To switch on, see **Use more of your TV > Use EasyLink > Hear another device at TV standby** (Page 18).

What you need

To benefit from Philips EasyLink advanced control features, make sure that you do the following:

- Connect at least two HDMI-CEC compliant devices through HDMI
- Configure each HDMI-CEC compliant device properly
- Switch on EasyLink

Control devices simultaneously

If you connect multiple HDMI-CEC devices that support this setting, all the devices respond to the TV remote control.

Caution:

This is an advanced setting. Devices that do not support this setting will not respond to the TV remote control.

Select speaker output

If the connected device is HDMI Audio Return Channel (HDMI ARC) compliant, you can output TV audio through HDMI cable. Additional audio cable is not required. See **Connect your TV > About cables > HDMI** (Page 35).

Following options can be selected:

- **[Off]**: Switch off TV speakers.
- **[On]**: Switch on TV speakers.
- **[EasyLink]**: Stream TV audio through the connected HDMI-CEC device.
Switch the TV audio to the connected HDMI-CEC audio device through the adjust menu.
- **[EasyLink autostart]**: Turn off TV speakers automatically and stream TV audio to the connected HDMI-CEC audio device.

Select speaker output with Adjust menu

If **[EasyLink]** or **[EasyLink autostart]** are selected, access the adjust menu to switch the TV audio:

[TV] : On by default.

Stream TV audio through TV and the connected HDMI-CEC audio device until the connected device switches to system audio control. TV audio is then streamed through the connected device.

[Amplifier]: Stream audio through the connected HDMI-CEC device. If system audio mode is not enabled on the device, audio continues to stream from the TV speakers.

If **[EasyLink autostart]** was enabled, the TV prompts the connected device to switch to system audio mode.

6. Set up your TV

Introduction

This TV is a special TV that allows the TV to be configured for a hotel application. This section describes how to install and operate this TV. Before reading this section, please also read section 4 to understand the basic functionality of this TV.

Benefits of specific Hotel TVs

This TV is specially designed to operate in Professional Mode. Professional Mode offers the following benefits:

Access to the **[TV Setup Menu]** can be blocked. This prevents users (e.g. guests) from deleting or changing channel settings and / or modifying picture and sound settings. This ensures that TVs are always set up correctly.

As example:

A switch-on volume and channel can be set. After switching on, the TV will always start on the specified volume level and channel.

The maximum volume level of the TV can be limited in order to prevent disturbance to other guests.

Channels can be blanked (Video only).

The TV local buttons **VOLUME +/-**,

P/CH+/- and **Home** can be locked.

Screen information can be suppressed.

Professional Setup Remote control (22AV8573 optional)

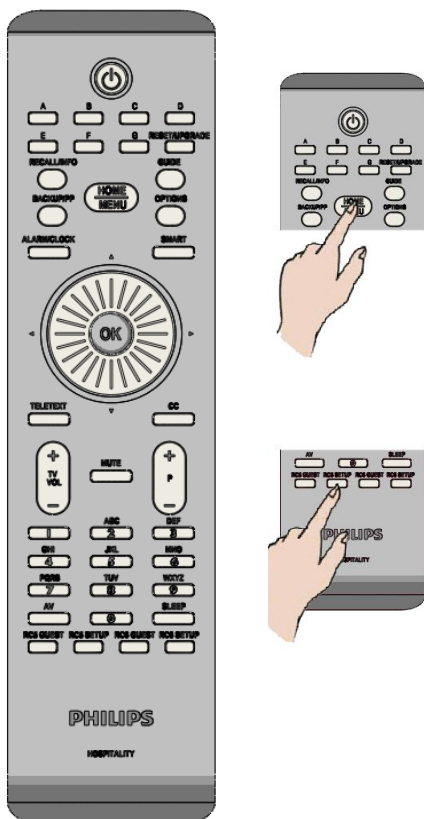

To enter the Professional Setup menu:

- press RC5 Setup
- press Home/Menu

On a Guest remote:

- Press **[3, 1, 9, 7, 5, 3, ✕]**

Setup mode should be used by Installer to make the required settings.

Professional mode options

This paragraph describes the functionality of each item in the Professional mode setup menu.

Enter the next layer by pressing **[OK]**, or **[>]**. Return to a previous level by pressing **[<]**.

Navigate in the current layer by pressing **[^]**, or **[v]**.

Layer 1	Layer 2	Layer 3	Layer 4	
PBS Setup	PBS Setup menu language	English, Français, Deutsch, Italiano		
	PBS Mode	Off / On		
	Room ID	####		
	Switch on settings	Switch on volume		[0..60] Slider [15]
		Maximum volume		[0..60] Slider [60]
		Switch on channel		[List: AV & RF channels]
	Switch on Picture Format			Watch TV Auto fill
				HDMI 1 Auto Zoom
				HDMI 2 Superzoom
				HDMI side Movie expand
				EXT 1 Wide screen
				EXT 2 Unscaled
	Welcome message	Display message	Off / On	
		Welcome Message Line 1		Edit text
		Welcome Message Line 2		Edit text
		Clear		Erase messages 1&2
		Message timeout		20s, 25s, 30s
	Control Settings	Local keyboard lock	Off / On / All	
		Remote control lock	Off / On	
		OSD display	Off / On	
		High security mode	Off / On	
		Browse NetTV	Off / On / Startup	
		Portal URL		[URL String]
		Welcome Logo	Off / On	
		Scenea (Hotel Information)	Off / On	
		Browse USB	Off / On	
		Auto scart		AV, Power On Scart, Off
		Easylink Break-in	Off / On	
		Easylink control	Off / On	
		Easylink Application menu	Off / On	
		Auto USB	Off / On	
		SXP Baudrate		38400 / 19200
		Enable CI Slot	Off / On	
		Enable Teletext	Off / On	
		Enable MHEG	Off / On	
		Enable EPG	Off / On	
		Subtitles at startup	Off / On / On during mute	
		Enable subtitles	Off / On	
		Enable Channel Map	Native / BDS	
		Installation		
	DVB C Off / On			
	Analog Off / On			
	Joint Space	Off / On		
	Freeze on No Signal	Off / On		

	Power settings	Power on	On / Standby
		Low power standby	Fast / Green
		Smart power	On / Off
		Auto switch off	On / Off
		Delayed reboot	On / Off
		Standby delay time-out	5 – 10 minutes
	Clock settings	Time Setting	<Entry> on manual
		Time Download	Automatic , manual
		Download Country	[List: Countries]
		Download Program	[List: RF channels]
Time Offset		<-12 – 0 – 12)	
Daylight saving	Daylight saving	Off / On	
	Feature settings	Multi RC	Off / Blue, Green, Yellow, Red
		VSecure Mode	Stand Alone / Connected / RF static
		Load key to USB	<Action>
		Load key to TV	<Action>
Vsecure self test		<Action>	
		Program Info	Frequency, Medium, Service ID, ONID, NID, TSID, Symbol Rate, Modulation
		Erase key option	Shared key, Odd key, Even key, All
		Erase key	<Action>
	Speaker settings	TV Speaker Enable	Off / On / EasyLink / EasyLink autostart
		Independent Main Speaker Mute	Off / On
		Default Main Speaker Volume	[0..60] Slider [15]
		Default Headphone Volume	[0..60] Slider [15]
Factory default	<Action>		
TV setup	Enter Consumer Mode	<Action>	OK / Cancel
Channel setup	Enter TV Channel Setup	<Action>	
Source Selection	Enable / Disable AV channels	<Action>	Off / On
Store Settings	Save all made changes	<Action>	
Smart Clone	USB to TV	<Action>	
	TV to USB	<Action>	
RF Download	SW types	SSB Firmware / SSB NVM / Standby Firmware / ThemeTV / Express Box, Welcome Logo / Hotel Information / All	
	Program Info	Frequency, Medium, Service ID, ONID, NID, TSID, Symbol Rate, Modulation	
	Start Download	<Action>	

Setup settings

PBS Setup

[PBS Setup menu language]

Select Setup menu language to set menu language as English, French, German or Italian.

[PBS Mode]

Enables / disables the Professional Hotel mode.

[On]: All settings in the Professional mode Setup menu are in effect.

[Off]: The TV operates as alike a normal (consumer) TV.

[Room ID]

Entry field to store 4 digits to identify Room Identifier.

[Switch on settings]

[Switch on volume]

When the guest switches the TV on, it will play at the specified volume level.

[Maximum volume]

This option specifies the maximum allowable volume level of the TV.

[Switch on channel]

When the guest switches the TV on, it will play at the specified channel.

[Switch on picture format]

This menu entry allows defining the picture format at startup for each of the available video sources.

[Welcome message]

The Welcome message function allows the TV to show a customized greeting to the hotel guest whenever the TV is switched on. This helps to personalize the hotel experience for guests. The Welcome message can consist of 2 lines of text, with each line containing a maximum of 20 alphanumeric characters. Use Navigation buttons on the remote control to compose the Welcome message.

Welcome message is always disabled if PBS Mode is Off

[Display message]:

Select to show the welcome message at power up cycle:

[On] to activate, [Off] to disable

[Welcome message line 1]:

[Line 1]: Sets the characters of the first line message.

[Welcome message line 2]:

[Line 2]: Sets the characters of the second line message.

[Clear]:

Erases the text stored in line 1 and line 2.

[Message line 1]:

Select the time that at startup the welcome message is displayed.

[Control Settings]

[Local Keyboard lock]

- [Off]: The TV local buttons will function normally.
- [On]: The TV local buttons are locked, except the **[POWER]** button.
- [All]: All the TV local buttons are locked.

[Remote Control lock]

- [Off]: All buttons on Guest remote control will function normally.
- [On]: All buttons on the Guest remote control are disabled.

*(It is still possible to enter the PBS Setup menu using the setup RC or by pressing [3, 1, 9, 7, 5, 3, *] (MUTE)).*

[OSD display]

Set this function to show or hide screen information.

- [Off]: Screen information is suppressed.
- [On]: Normal screen information is displayed.

[High security]

- [Off]: Professional mode setup menu can be accessed by both Guest remote control (Press [3, 1, 9, 7, 5, 3 + *] (MUTE)) and the Professional setup remote control)
- [On]: Professional mode setup menu can only be accessed by the Professional setup remote control

[Welcome Logo]

Enables / disables to show the stored welcome Logo at start-up when TV starts up in Green Mode (see Power Settings):

- [On]: When set to On, the TV will show the Welcome Logo at start-up.
- [Off]: When set to Off, the TV will hide the Welcome Logo at start-up.

[Browse NetTV]

This menu entry allow enabling NetTV feature. If Browse NetTV is set to off the feature is disabled and the NetTV icon is removed from the guest menu. If set to on the feature is enabled and the feature is accessible via an icon in the guest menu.

If startup is selected the feature is enabled and the portal will be loaded at startup.

[Portal URL]

This menu entry allow to enter a URL to connect to a custom designed CE-HTML portal.

[Browse USB]

Enables / disables the USB Browse icon to be presented in the Guest Menu.

- [On]: When set to On, the TV will show the USB icon in the Home menu.
- [Off]: When set to Off, the TV will hide the USB icon in the Home menu.

[Scenea]

This menu entry enable/disable the Hotel information feature.

If it is set to off the feature is disabled and the hotel information icon is removed from the guest menu.

If it is set to on the feature is accessible via the hotel information icon in the guest menu.

[Auto scart]

Enables auto scart switching (or break-in) in Professional mode.

- [AV]: Enables auto scart switching or break-in.
- [Power On Scart] Enables auto TV start On/Off when detecting scart break-in. (never use this feature without a connected STB)
- [Off]: Disables auto scart switching or break-in.

[Easylink break-in]

Enables or disables HDMI-CEC standby feature in Professional mode:

- [Off]: Not able to switch on the TV by external HDMI-CEC devices.
- [On]: Able to switch on the TV by external HDMI-CEC devices.

[Easylink control]

Enables or disables HDMI-CEC one touch play feature in Professional mode:

- [Off]: Disables TV functionality to control external HDMI-CEC devices.
- [On]: Enables TV functionality to control external HDMI-CEC devices.

[Easylink Application Menu]

Allows menu to control external HDMI-CEC.

- [Off]: Disables TV functionality to control external HDMI-CEC devices.
- [On]: Enables TV functionality to control external HDMI-CEC devices.

[Auto USB]

Enables or disables USB break-in feature in Professional mode:

- [Off]: When USB device is plugged in, the [Multimedia] menu will not appear automatically, but users can access [Multimedia] menu from the Guest menu.
- [On]: When USB device is plugged in, the [Multimedia] menu appears automatically.

[SXP Baudrate]

Sets the Baudrate for the SerialExpress communication channel to be 38200 or 19200 Baud (bits per second).

[Enable CI-slot]

Enables or disables the use of the integrated CI/CI* slot:

- [Off]: No pass through of TV input signal via the CI-Slot Card is possible; use of CI-Card slot is not possible.
- [On]: Pass through of TV input signal via the CI-Slot Card is possible; use of CI-Crad slot is possible. Check with your local operator if CI-Card is compatible with this TV.

[Enable Teletext]

Enables or disables the use of Teletext OSD on pressing Teletext button:

- [Off]: No Teletext services available (*Prison Mode*)
- [On]: Teletext services available

[Enable MHEG]

Enables or disables the use of MHEG OSD on pressing MHEG button:

- [Off]: No MHEG services available (*Prison Mode*)
- [On]: MHEG services available

[Enable EPG]

Enables or disables the use of EPG OSD on pressing EPG button:

- [Off]: No EPG services available (*Prison Mode*)
- [Now & Next]: EPG (*Now/Next*) services available
- [8 Day EPG]: EPG (*8 Day*) services available

[Subtitles at Startup]

Enables or disables the use of subtitles at start-up:

- [Off]: No subtitles services available (*Prison Mode*)
- [On]: Subtitles services available
- [On during mute]: Subtitles services when TV audio is muted

[Enable Subtitles]

Enables or disables the use of subtitles in a DVB broadcast channel:

- [Off]: No subtitles services available
(*Prison Mode*)
- [On]: Subtitles services available

[Enable Channel Map]

Select Channel Map to be viewed:

- [Native]: Show standard default channel map
- [BDS]: To be used only if a STB is connected

[Installation]

This setting allows selecting which RF signal will be scanned during channel installation. Each entry [DVB-T/T2 – DVB-C - Analog] is can be set on (enabled) or off (disabled).

[Joinspace]

This feature is not supported for hotel mode. Always set it to off.

[Freeze on no signal]

When this feature is enabled TV will keep on screen the last receive frame in case of signal loss on DVB signals.

[Power settings]**[Power on]**

The power on function allows the TV to enter a specific mode ([On], [Standby]) of operation when the mains power is activated (*cold start*):

- [On]: The TV will always turn on (show startup channel) after the mains power is activated.
- [Standby]: When set, the TV will always turn to standby (status as defined in Low power standby option) after the mains power is activated.

[Low power standby]

The Low power standby option defines the TV to enter a specific standby mode after pressing the On/Off button on the remote control. To wake-up the TV both On/Off button on the RC or TV can be pressed:

- [Fast]: The TV will quickly turn on (show startup channel. (*This mode is having more power consumption then the Green mode*).
- [Green]: The TV will slower turn on (show startup channel) then the Fast. (*This mode is having less power consumption then the Fast mode*).

[Smart power]

The power consumption for the Smart power mode is defined by the Smart Picture setting in the TV Setup part.

- [Off]: The TV will start with Standard Smart Picture setting, but the setting can be changed in the guest setup mode.
- [On]: The TV will start with “Energy Saving” Smart Picture setting and Smart Picture setup and is not selectable in the guest setup mode. (*with this the power consumption mode is predictable*).

[Auto switch off]

Enables or disables the use of automatic switch off the TV if no RC action is noticed after 240 minutes:

- [Off]: TV will not switch off after 240 minutes
- [On]: TV will switch of after 240 minutes

[Delayed reboot]

Enables or disables the use of delayed standby:

- [Off]: No delay added when guest presses 'Off' button.
- [On]: Delay added when guest presses 'Off' button before going into standby; in case of a wrong guest interaction, activating the TV after this will be done directly without any startup delay.

[Delayed reboot timeout]

This setting allows selecting how long the TV will wait to reboot once delayed reboot is enabled. There are 2 options: 5 minutes and 10 minutes.

[Clock settings]

[Time Setting]

This is only available if the Time Download is set to Manual and can be used to set the clock with the remote control:

- [Set]: Time entry field [xx:xx Hr]
Time to be set by using arrow keys and numeric buttons

[Time Download]

Select source for clock time:

- [Automatic]: Clock time is retrieved from the Download Program channel.
- [Manual]: The clock time is set using the Time Setting option.

[Download Country]

Set selected country as source for clock time.

[Download Program]

Set selected Download Program as source for clock time. (Recommend to set this to a channel that originate from the installed country to ensure proper local time)

[Time Offset]

Offset time added to the downloaded clock time:

- [Slider]: -12 to 12 hr

[Daylight saving]

Set the Daylight saving options:

- [Set]: Off, On

[Feature settings]

[Multi RC]

This function allows that up to four televisions can be installed in a room whereas every TV will listen to its own RC. Once the TV is set, also every RC can be set to remember its connected TV:

- [Off] This function is not used; all TVs will listen to a 'blue' RC.
- [Blue] The TV will listen to a 'blue' RC.
- [Green] The TV will listen to a 'green' RC.
- [Yellow] The TV will listen to a 'yellow' RC.
- [Red] The TV will listen to a 'red' RC.

Press and hold both the menu and colored button on the RC for more than two seconds.

[VSecure]

VSecure is the hospitality content scrambling method used by the Philips Hospitality TVs. With its internal VSecure Authorization key a VSecure Unprotect key can be generated. If this VSecure Unprotect key is stored in the TV, the TV is able to descramble protected content. Loading the VSecure Unprotect key can be done by USB memory device or via DVB RF:

[Mode]

- [Stand alone]: The VSecure Unprotect key is to be stored once via USB and will remain available until manual erasing it.
- [Connected]: The VSecure Unprotect key is to be send via serialXpress RF and will remain valid until power down or receiving a successive VSecure Unprotect key.
- [RF Static]: The VSecure Unprotect key is to be stored via RF and will remain valid until manual erasing it or receiving a successive VSecure Unprotect key.

[Load key to USB]

- [Action] Place a USB memory device in the USB side I/O.
- Press '>' or '**OK**' to copy the VSecure Authorization key to the USB memory device

[Load key to TV]

- [Action] Place a USB memory device with a valid VSecure Unprotect key in the USB side I/O.
- Press '>' or '**OK**' to copy the VSecure Unprotect key to the USB memory device

[Vsecure self test]

- [Action] Internal self test to validate VSecure. After this load proper hotel specific keys.

[Program Info]

This function is to set the necessary DVB parameters to locate the proper VSecure RF channel to load the VSecure RF Static or RF Dynamic key(s):

[Frequency]	Frequency of MUX (####)
[Medium]	Cable or Antenna (DVB T)
[Service ID]	#####
[ONID]	#####
[NID]	#####
[TSID]	#####
[Symbol Rate]	#.###
[Modulation]	QAM16, QAM32, QAM64, QAM128, QAM256

Above parameters must match head-end configuration

[Erase key option]

This function is to set the stored VSecure Unprotect key(s) to erase:

[Shared key]	Erase the Shared key
[Odd key]	Erase the Odd key
[Even key]	Erase the Even key
[All keys]	Erase the Shared, Odd and Even keys

[Erase key option]

This function is erase the key that were selected by the Erase key option:

[Action]	Press '>' or ' OK ' to erase the key(s).
----------	---

[Speaker settings]

This function defines the simultaneously working of the integrated main speakers and the headphone/bathroom speaker:

[TV Speaker Enable]

- [Off]: The main speakers are muted. The RC can control the volume and mute of the headphone/bathroom speaker
- [On]: The main speakers are active and the behavior of the headphone/bathroom speaker is defined by the Independent Main Speaker Mute.
- [EasyLink]: xxxx
- [EasyLink autostart]: xxx

Independent Main Speaker Mute]

- [Off]: The RC volume and mute will control the main speakers and headphone / bathroom speaker simultaneously.
- [On]: If the main speakers are muted by the RC, the RC will control the volume of the headphone/bathroom speaker

[Default Main Speaker Volume]

This option defines the volume level that will be set to the main speakers when the TV is unmuted and the Independent Main Speaker Mute is set to 'On'.

[Default headphone volume]

Not implemented.

[Factory default]

Restore the factory picture and sound setting. Channel installation is not changed.

TV Setup

With this option, all basic TV functionality can be configured. If any setting is changed within the PBS Menu, they should be stored before pressing [OK], otherwise they will be discarded.



Select Setup to make changes to the TV settings

Change picture and sound settings (with PBS setup RC)

Picture settings

1. Press [**Home/Menu**] > [**TV Setup**].
2. Select [**Setup**] > [**TV settings**] > [**Picture**], then press **OK**.
3. Select a setting to adjust and press **<OK>**:

- [**Smart picture**]: Accesses pre-defined smart picture settings.
 - [**Personal**]: Sets the TV to your personal preferences.
 - [**Vivid**]: Rich and dynamic settings, ideal for daylight use.
 - [**Natural**]: A natural picture setting.
 - [**Cinema**]: Ideal settings for watching movies.
 - [**Game**]: Ideal settings for gaming.
 - [**Energy saving**]: The most energy-conscious settings.

- [**Standard**]: Adjusts picture settings to suit most environments and types of video. Is Factory default setting.

- [**Photo**]: Ideal settings for viewing photos.

- [**Custom**]: Allows you to customise and store personal picture settings.

Press **OK** to confirm your choice.

- [**Reset**]: Resets to factory default settings.

Press **OK** to confirm your choice.

- [**Contrast**]: **Adjusts** the intensity of bright areas, keeping dark areas unchanged.

Press **OK** to confirm your choice.

- [**Brightness**]: Adjusts the intensity and details of dark areas.

Press **OK** to confirm your choice.

- [**Colour**]: Adjusts colour saturation.

Press **OK** to confirm your choice.

- [**Hue**]: Compensates colour variations in NTSC encoded transmissions.

Press **OK** to confirm your choice.

- [**Sharpness**]: Adjusts sharpness in the image.

Press **OK** to confirm your choice.

- [**Noise reduction**]: Filters and reduces noise in an image.

Press **OK** to confirm your choice.

- [**Tint**]: Adjusts the colour balance in an image.

Press **OK** to confirm your choice.

- **[Custom tint]:** Customises tint setting.
Press **OK** to confirm your choice.
 - **[Pixel Plus HD]:** Accesses advanced settings, including [HD Natural Motion], [100 Hz Clear LCD], [Advanced sharpness], [Dynamic contrast], [Dynamic backlight], [MPEG artifact reduction], [Colour enhancement], [Gamma].
Press **OK** to confirm your choice.
 - **[PC mode]:** Enables picture settings adjustment when a PC is connected to the TV via HDMI. If enabled, you can select **[Picture format]** to be unscaled which provides maximum detail for display of PC content.
Press **OK** to confirm your choice.
 - **[Picture format]:** Changes the picture format.
Press **OK** to confirm your choice.
 - **[Screen edges]:** Changes the picture size.
Press **OK** to confirm your choice.
 - **[Picture shift]:** Adjusts the position of the picture. Not applicable if selected picture format is **[Auto zoom]** or **[Wide screen]**.
Press **OK** to confirm your choice.
4. Press **[Back/PP]** to return to TV Setup Menu.
 5. Press **[Back/PP]** to exit.

Smart sound settings

1. Press **[Home/Menu] > [TV Setup]**.
2. Select **[Setup] > [TV settings] > [Sound]**, then press **OK**.
3. Select a setting to adjust and press **<OK>**:
 - **[Smart sound]:** Accesses pre-defined smart picture settings:
 - **[Personal]:** Sets the TV to your personal preferences.
 - **[Standard]:** Adjusts sound settings to suit most environments and types of audio.
 - **[News]:** Applies sound settings ideally suited for spoken audio, such as the news.
 - **[Movie]:** Applies sound settings ideally suited for movies.
 - **[Game]:** Ideal settings for gaming.
 - **[Drama]:** Applies sound settings ideally suited for drama.
 - **[Sports]:** Applies sound settings ideally suited for sports.
Press **OK** to confirm your choice.
 - **[Reset]:** Resets to factory default settings.
Press **OK** to confirm your choice.
 - **[Bass]:** Adjusts the bass level.
Press **OK** to confirm your choice.
 - **[Treble]:** Adjusts the treble level.
Press **OK** to confirm your choice.
 - **[Surround]:** Enables spatial sound.
Press **OK** to confirm your choice.
 - **[Headphones volume]:** Adjusts headphone volume.
Press **OK** to confirm your choice.

- **[Auto volume leveling]:**
Automatically reduces sudden volume changes, for example, when switching channels.
Press **OK** to confirm your choice.
 - **[Balance]:** Adjusts the balance of the left and right speakers to best suit your listening position.
Press **OK** to confirm your choice.
4. Press **[Back/PP]** to return to TV Setup Menu.
 5. Press **[Back/PP]** to exit.
- **[TV Speakers]:** Enables /Disables TV Speakers EasyLink control:
 - **[Off]:** No EasyLink functionality
 - **[On]:** EasyLink functionality enabled
 - **[EasyLink]:** No EasyLink functionality
 - **[EasyLink autostart]:** EasyLink functionality enabled
 Press **OK** to confirm your choice.
 - **[HDMI 1 -ARC]:** Enables /Disables Audio Out on HDMI 1:
 - **[Off]:** No EasyLink functionality
 - **[On]:** EasyLink functionality enabled
 Press **OK** to confirm your choice.

EasyLink

1. Press **[Home/Menu]** > **[TV Setup]**.
2. Select **[Setup]** > **[TV settings]** > **[EasyLink]**, then press **OK**.
3. Select a setting to adjust and press **<OK>**:

- **[EasyLink]:** Enables /Disables EasyLink:
 - **[Off]:** No EasyLink functionality
 - **[On]:** EasyLink functionality enabled
 Press **OK** to confirm your choice.
- **[EasyLink Remote Control]:**
Enables /Disables EasyLink RC:
 - **[Off]:** No EasyLink functionality
 - **[On]:** EasyLink functionality enabled
 Press **OK** to confirm your choice.

4. Press **[Back/PP]** to return to TV Setup Menu.
5. Press **[Back/PP]** to exit.

Preferences

1. Press **[Home/Menu]** > **[TV Setup]**.
 2. Select **[Setup]** > **[TV settings]** > **[Preferences]**, then press **OK**.
 3. Select a setting to adjust and press **<OK>**:
- **[Menu language]:** Set the required menu language.
Press **OK** to confirm your choice.
 - **[Sleep timer]:** Set the required sleep timer time-out **[0..180 min]**.
Press **OK** to confirm your choice.

- **[Volume bar]:** OSD.
 - [Off] No volume bar OSD
 - [On]** Show volume bar OSD
 Press **OK** to confirm your choice.

 - **[Channel information size]:** OSD.
 - [Classic]** Normal OSD
 - [Big] Larger sized OSD
 Press **OK** to confirm your choice.

 - **[Auto switch off]:** switch off after 240 min:
 - [Off] No automatic switch off
 - [On]** Automatic switch off
 Press **OK** to confirm your choice.

 - **[Universal access]:**
 - [Off] No Universal Access
 - [On]** Universal Access
 Press **OK** to confirm your choice.

 - **[Key beep]:**
 - [Off]** No audio beep on pressing RC button
 - [On]** Audio beep on pressing RC button
 Press **OK** to confirm your choice.

 - **[Audio Out Delay]:** Set delay on Audio Out.
 - [Off] No delay
 - [On]** delay inserted
 Press **OK** to confirm your choice.

 - **[TV placement]:** Set position off TV, influence on audio quality.
 - [Wall mounted]
 - [On a TV stand]**
 Press **OK** to confirm your choice.

 - **[Text 2.5]:** Set Teletext 2.5
 - [Off] Not set (older version used)
 - [On]** 2.5 used
 Press **OK** to confirm your choice.

 - **[Clock]:** Set internal clock
 - [Auto clock mode] Not set
 - [Daylight saving] Not set
 - [Date] Not set
 - [Time] Not set
 Press **OK** to confirm your choice.
4. Press **[Back/PP]** to return to TV Setup Menu.
 5. Press **[Back/PP]** to exit.

Reset to factory settings

Resetting your TV to factory settings restores default picture and sound settings.

Channel installation settings remain the same.

1. Press **[Home/Menu]** > **[TV Setup]**.
2. Select **[Setup]** > **[TV settings]** > **[Factory settings]**, then press **OK**.

TV settings are reset back to the factory default.

Reinstall TV

Starts a TV initialization to reset all settings to default and replace (reinstall) all channels.

1. Press **[Home/Menu]** > **[TV Setup]** > **[OK]**.
2. Select **[Setup]** > **[TV settings]** > **[Reinstall TV]**, then press **OK**.

TV will perform a power down cycle going into standby and then starts-up again. If the TV stays in Standby mode, wake TV up with switch on button on remote control.

1. Region OSD is displayed:
Region Australia
 Europe
Select **[Europe]** and press **<OK>**.
2. Select language OSD is displayed:
Select **[xxxx]** (i.e. language from list) and press **<OK>**.
3. Select install country OSD is displayed:
Select **[xxxx]** (i.e. country from list) and press **<OK>**.
4. Select TV placement OSD is displayed:
[Wall mounted]: in case of wall mounting
[On a TV stand]: in case of stand

and press **<OK>**.

5. Universal access for the visual and hearing impaired OSD is displayed:

[No]: No special settings
[Yes]: Special settings configured

and press **<OK>**.

6. Press **[Settings]** to continue and install channels.

Perform the following steps:

[Install TV channels] and press **<OK>**
[Continue]
[Settings]

A screen is displayed to make changes to set the channel list/map configuration:

[Symbol rate mode]:	Automatic TV will use the preset Symbol rate (6.900/6.875)
	Manual Option to set Symbol rate 1 and Symbol rate 2
[Symbol rate 1]:	0.000 (to set)
[Symbol rate 2]:	0.000 (to set)
[Frequency scan]:	Quick scan Install channels based on a pre-configured data table
	Full scan Install channels based on scanning the whole frequency spectrum
[Frequency step]:	1 MHz With Full scan, step size to search for channels is 1 MHz
	8 MHz With Full scan, step size to search for channels is 8 MHz

[Network Frequency Mode]: Automatic
 TV will set the Network frequency based on a pre-configured data table
Manual
 Option to set Network frequency

[Network Frequency]: 000.00 (to set)

[Analogue channels]: **On**
 TV will scan also analogue channels
Off
 TV will not scan analogue channels

[LCN Sorting]: **On**
 TV will scan also analogue channels
Off
 TV will not scan analogue channels

[Reset]: On

[Done]: Once finished select [Done] and press <OK>

More Channel Settings

1. Press [**Home/Menu**] > [**TV Setup**] > [**OK**].
2. Select [**Setup**] > [**Channel settings**], then press **OK**.
3. Select a setting to adjust and press <**OK**>:

- [**Languages**]: Set the required DVB languages.
- [**Primary audio**]: Sets the Primary audio channel to the selected country language.
- [**Secondary audio**]: Sets the Secondary audio channel to the selected country language.
- [**Primary subtitles**]: Sets the Primary subtitles to the selected country language.
- [**Secondary subtitles**]: Sets the Secondary subtitles to the selected country language.
- [**Primary text**]: Sets the Primary text to the selected country language.
- [**Secondary text**]: Sets the Secondary text to the selected country language.
- [**Visually impaired**]: Sets the feature Visually impaired to support:
 - [**Off**]:
 - [Speakers]:
 - [Headphones]:
 - [Speakers + headphones]:

7. Press [**Start**] to continue.
8. If a preset Network Frequency is not available, or the Network Frequency Mode is set as manual, Enter the Network Frequency and press [**Done**] to continue.
 Press [**Cancel**] if no DVB-C to install (only DVB-T and Analogue).
9. Once the channel list is configured, the TV shows how many digital and analog channels are captured and returns to the TV Setup OSD.
10. Press [**Done**] > [**Skip**] > [**Finish**] > [**Close**] to return to the TV Setup Menu. If PBS Mode is [On], the Guest menu is displayed.

- **[Preferred audio format]:** Sets the feature preferred audio format:
[Standard]:
[Advanced]:
- **[Mono/Stereo]:** Sets the feature audio format:
[Mono]:
[Stereo]:

Press **OK** to confirm your choice.

Channel installation

Before starting to install channels specific settings must be set to get the channels to be installed (see reinstall, Page 30)

1. Press **[Home/Menu] > [TV Setup] > [OK]**.
2. Select **[Setup] > [Channel settings]**, then press **OK**.
3. Select a setting to adjust and press **<OK>**:

- **[Channel installation]:**
Configure the proper installation settings:
- **[Automatic Channel Update]:** This TV can automatically rescan the entire channel configuration once every day if this feature is set and the TV is in Standby mode.
[Off]: No automatic updating
[On]: At TV clock 5.00 AM channel updating starts

- **[Channel Update Message]:** Once the TV has updated its channel list due to an Automatic Channel Update, this OSD will inform about the occurrence
[Off]: No updating message
[On]: After an update cycle an OSD message will be displayed once the TV is switched on.

- **[Digital: Reception test]: Test scan**

Will install channels that are available in the setted MUX frequency

[Symbol rate mode]: **Automatic**
TV will use the preset Symbol rate (6.900/6.875)
Manual
Option to set Symbol rate 1 and Symbol rate 2

[Symbol rate 1]: 0.000 (to set)

[Symbol rate 2]: 0.000 (to set)

[Search]: Start the test scan

Set the frequency for the selected MUX **[000.00]** and press **[Search]**.

After finding the channels press **[Done]**.

- **[Analogue: Manual installation]:**
Will install a analogue channels that is available in the whole frequency spectrum.
Set the necessary values:

[System]:	West Europe East Europe UK France
[Find channel]:	000.00 (to set) [Search] > [Done]
[Fine tune]:	000.00 (to set) Press ▲ ▼ or ▼ to fine tune the channel. [Done]
[Store current channel]:	Store the fine tuned channel under the current channel store under a new channel number.
[Store as new channel]:	Store under a new channel number.

4. Press **[Back/PP]** to return to TV Setup Menu.
5. Press **[Back/PP]** to exit.

Child lock

Child lock is a mechanism to prevent viewing a channel that has a higher Parental rating then set with this feature.

1. Press **[Home/Menu] > [TV Setup] > [OK]**.
2. Select **[Setup] > [Child lock]**, then press **OK**.
3. Select a setting to adjust and press **<OK>**:
 - **[Parental rating]:** Set the proper value (only once a code has been set)
 - **[Channel lock]:** Mark the channels that are influenced by the Parental rating
 - **[set code]:** Enter a 4 digit code and press **<OK>**
4. Press **[Back/PP]** to return to TV Setup Menu.
5. Press **[Back/PP]** to exit.

Change channel settings

After installation, you may want to reorder the channel list to suit your preference.

1. Press [**Home/Menu**] > [**Channel setup**]
2. Select a channel to adjust and press <**OPTIONS**>:
 - [**Rename**]: Press <**OK**> to bring up the virtual keyboard and edit the name. Close this with [**Done**].
 - [**Done**] <**OK**>: Select Done and Press <**OK**> to store the channel name.
 - [**Reorder**]: Navigate to the selected channel to change and press <**OK**>. Move it to the desired location, then press **OK**. Select [**Insert**] to insert the channel into the desired location, [**Swap**] to swap location with another channel or [**Cancel**] to cancel the reorder. Press **OK** to activate.
 - [**Blank channels**] : Mark the list that needs to be blanked (Blank = hidden from the channel map) To view the channels again unmark this field. Press [**Back/PP**] to return to the Channel setup page.

Source Selection

Option to select if external AV is visible to guest. Mark fields to make a selection selectable to the guest.

Store Settings

To confirm the changes in the PBS Setup menu the changes **MUST** be stored.

1. select [**Store settings**] and press **OK**.
2. select [**OK**] to store settings
3. select [**Cancel**] to discard any changes

Smart Clone

With Smart Clone it is possible to copy to/from a USB device TV the configuration data and channel list data. Place a USB Memory stick in the USB side I/O connector of the TV.

*USB device should be formatted as FAT or FAT32.

USB to TV

1. select [**Smart Clone**] and press **OK**.
2. select [**USB to TV**] and press **OK**.
3. Clone data will be loaded from USB device into TV. To activate the loaded settings, wait until the OSD message is displayed to remove the power cord.
4. Remove and re-insert the power cord.

TV to USB

1. select [**Smart Clone**] and press **OK**.
2. select [**TV to USB**] and press **OK**.
3. Clone data will be loaded from TV into USB device.
4. wait until the OSD message returns to its earlier state before removing the USB device

Welcome Logo / Hotel Information

Welcome Logo and Hotel Information images can be stored in the TV using USB cloning an RF Download.

Put the images in the following USB locations and perform a USB to TV action.

Welcome Logo:

<USB:\>Q555H\WelcomeLogo
WelcomeLogo.jpg
File format: JPG, 960h x 540v pixels

Hotel Information:

<USB:\>Q555H\Wallpaper\HotelInfo.jpg
File format: JPG, scaled 16:9 format
(ie. 960h x 540v, 1280h x 720v,)

RF Download

Instead of using a USB memory device to do cloning and firmware update, this upgrading is also possible using the RF infrastructure. This is supported by SmartInstall (Philips Hospitality RF Download mechanism) and allows a simultaneous upgrade of televisions.

PBS Mode must be set to ON!

[SW Types]

Defining the software parts to be upgraded:

[SSB Firmware]	TV Firmware
[SSB NVM]	TV settings
[StandBy Firmware]	Firmware for the StandBy CPU
[Welcome Logo]	Graphic file
[Hotel Information]	Graphic file
[All]	All of above (except standby software)

[Program Info]

This function is to set the necessary DVB parameters to locate the proper RF download channel :

*[Frequency]	Frequency of MUX (default: 0706)
*[Medium]	Cable or Antenna (DVB T/C)
[Service ID]	##### (00001)
[ONID]	##### (00001)
[NID]	##### (00001)
[TSID]	##### (00001)
**[Symbol Rate]	# . ### (6.900)
**[Modulation]	QAM16, QAM32, QAM64 , QAM128, QAM256

**Mandatory items, **Mandatory items, but DVB-C only*

Above parameters must match head-end configuration

Start Download

To manual start a RF download action:

1. select **[RF Download]** and press **OK.**
2. select **[Start Download]** and press **OK.**

The download action will start and search if valid content is found on the RF network.

Automatic download will start every day at 4.00AM, 1.00PM.

7. Connect your TV

About cables

Cable quality

Overview

Before you connect devices to the TV, check the available connectors on the device. Connect the device to the TV with the highest quality connection available. Good quality cables ensure a good transfer of picture and sound. The connections shown in this user manual are recommendations only. Other solutions are possible.

Tip: If your device only has composite or RCA connectors, use a SCART-cinch adapter to connect the device to a SCART connector on the TV.

HDMI

An HDMI connection has the best picture and sound quality. An HDMI cable combines video and audio signals. Use HDMI for high-definition (HD) TV signals, and to enable EasyLink. An HDMI Audio Return Channel (ARC) connector allows output of TV audio to an HDMI ARC compliant device.

- Do not use an HDMI cable longer than 5 meters / 16.4 feet.

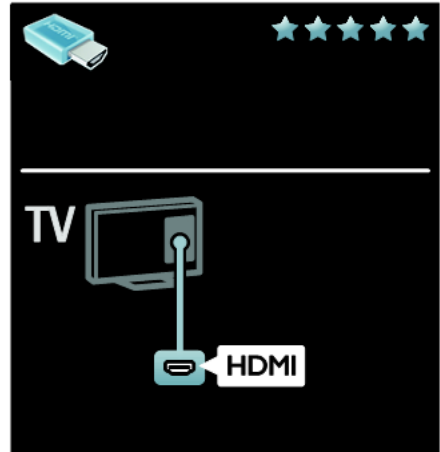

Y Pb Pr

Use the Component Video (Y Pb Pr) connection together with an Audio Left and Right connection for sound.

Y Pb Pr can handle high-definition (HD) TV signals.

Match the Y Pb Pr connector colors to the cable plugs.

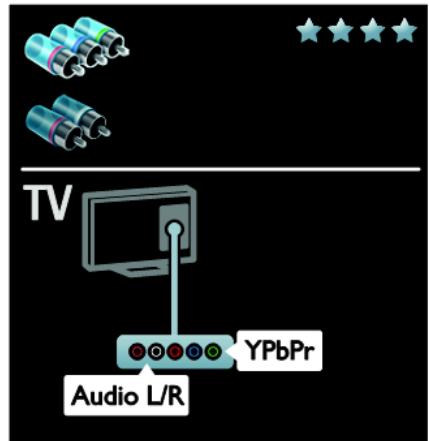

SCART

A SCART cable combines video and audio signals.

SCART connectors can handle RGB video signals but cannot handle high-definition (HD) TV signals.



VGA

Use this connection to display PC content on the TV

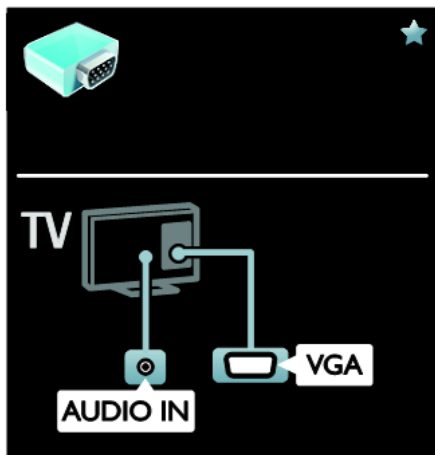

For video and sound, use the VGA and AUDIO IN connectors.

Connect devices

Overview

You can connect your devices to the TV with any of the following options. After connection, press **Home** > **[Add your devices]**

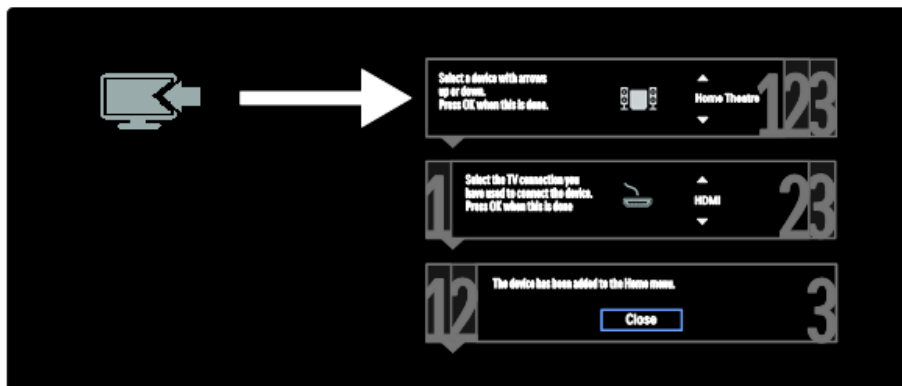

Blu-ray or DVD disc player

Connect the disc player with a HDMI cable to the TV.

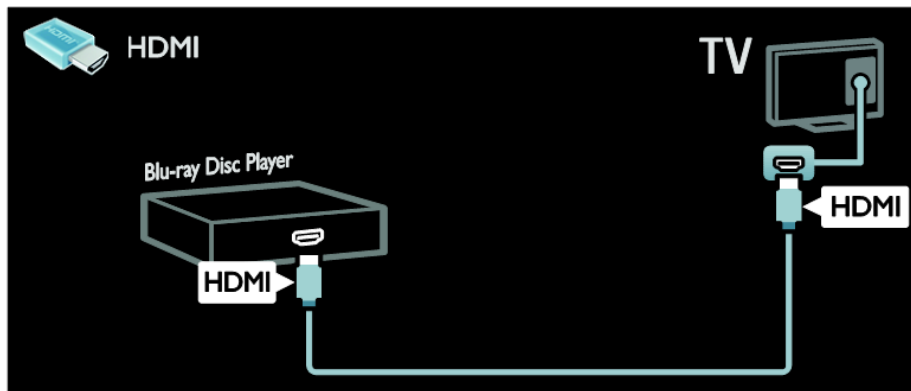

Connect the disc player with a component cable (Y Pb Pr) and an audio L/R cable to the TV.

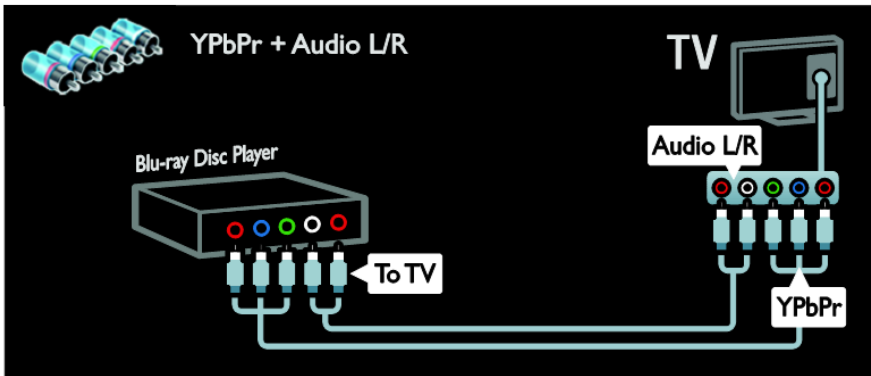

TV receiver

Connect the satellite or digital TV receiver with an antenna cable to the TV.
(SAT is available on certain models only.)

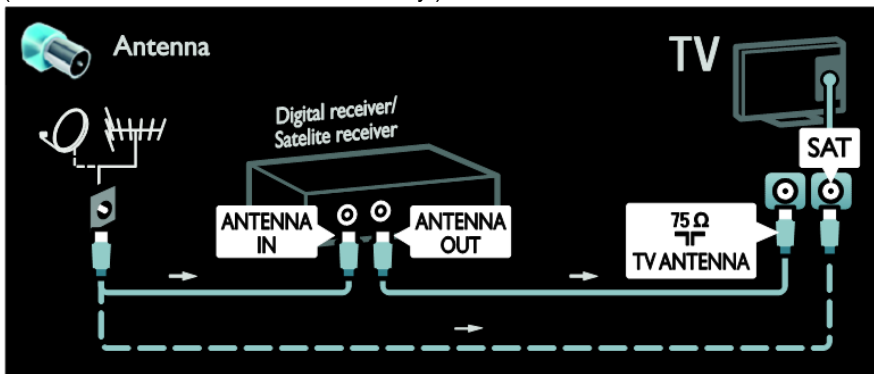

Connect the satellite or digital TV receiver with a HDMI cable to the TV.

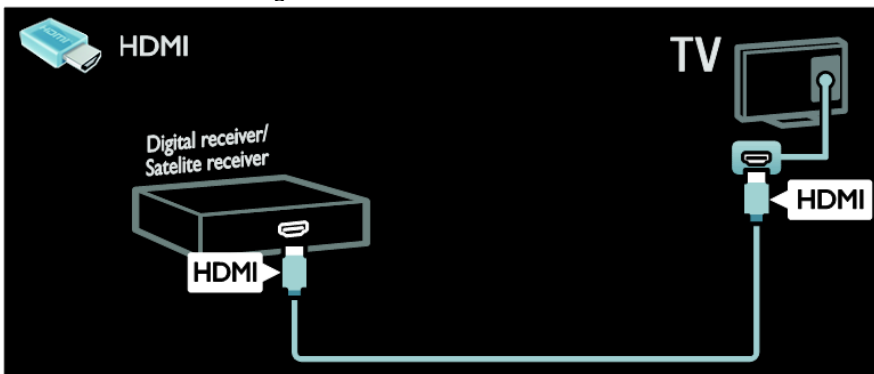

Connect the satellite or digital TV receiver with a SCART cable to the TV.

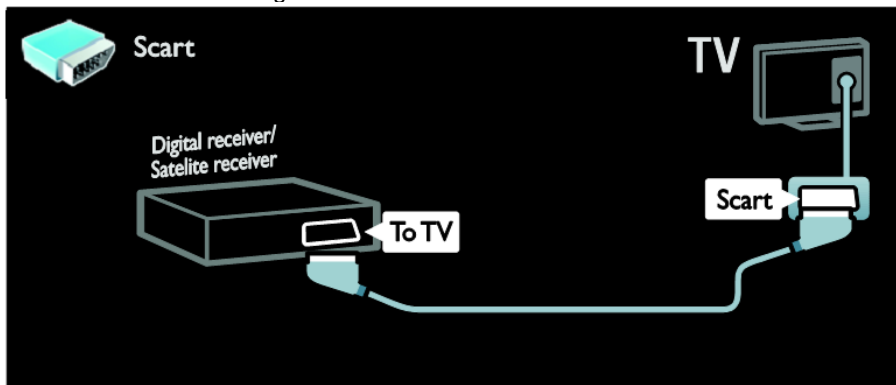

Connect the satellite or digital TV receiver with a component cable (Y Pb Pr) and an audio L/R cable to the TV.

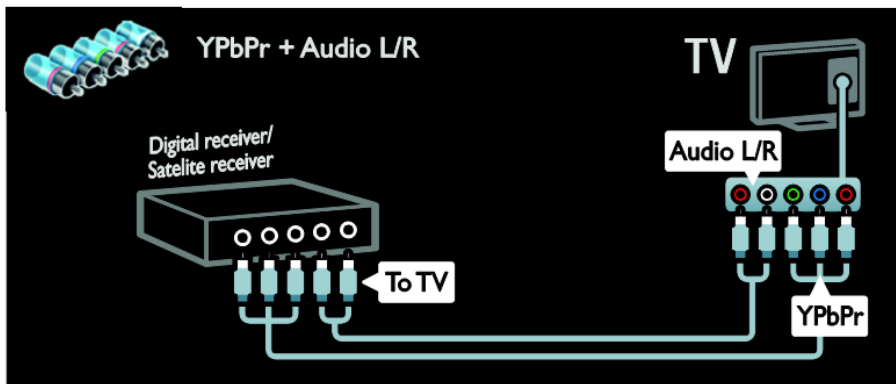

Recorder

Connect the recorder with an antenna cable to the TV. (SAT is available on certain models only.)

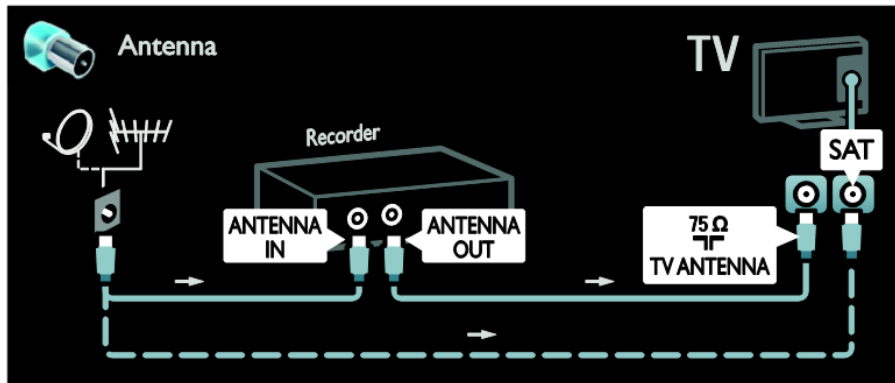

Connect the recorder with a SCART cable to the TV.

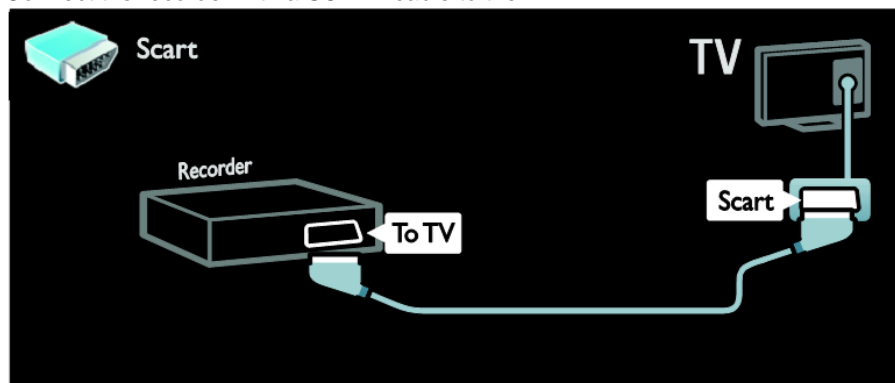

Connect the recorder with a component cable (Y Pb Pr) and an audio L/R cable to the TV.

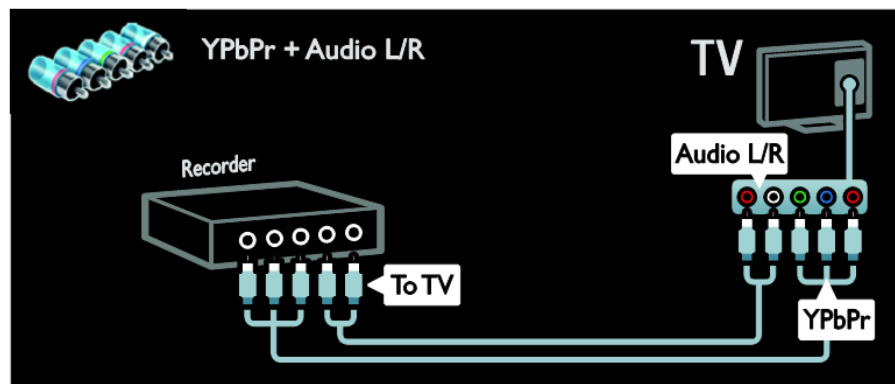

Game console

The most practical connectors for a game console are on the side of the TV. However, you can also use the connectors at the back of the TV.

For best gaming experience, set the TV to game mode.

1. Press **ADJUST**
2. Select **[Smart picture] > [Game]**, then press **OK**
3. To exit, press 

Connect the game console with a HDMI cable to the TV.

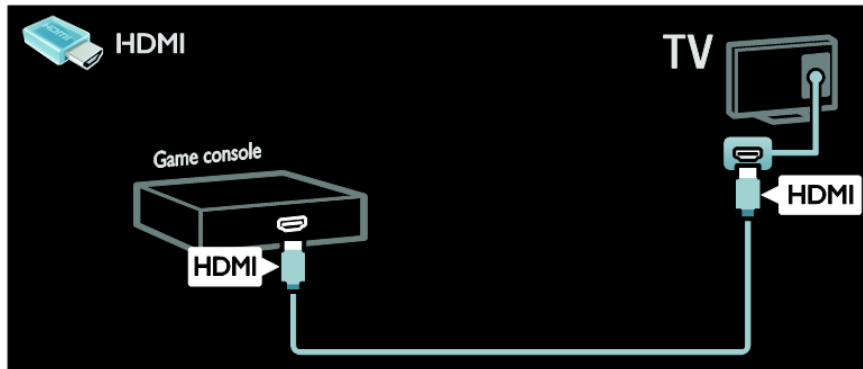

Connect the game console with a component cable (Y Pb Pr) and an audio L/R cable to the TV.

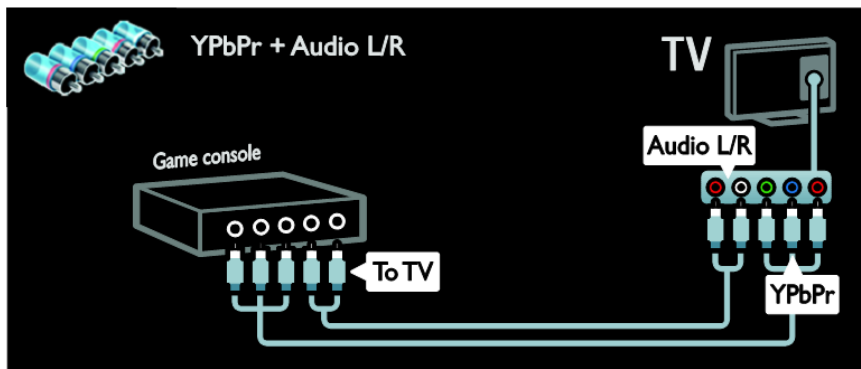

Home theater system

Connect the home theater with an HDMI cable and an optical or coaxial audio cable to the TV.

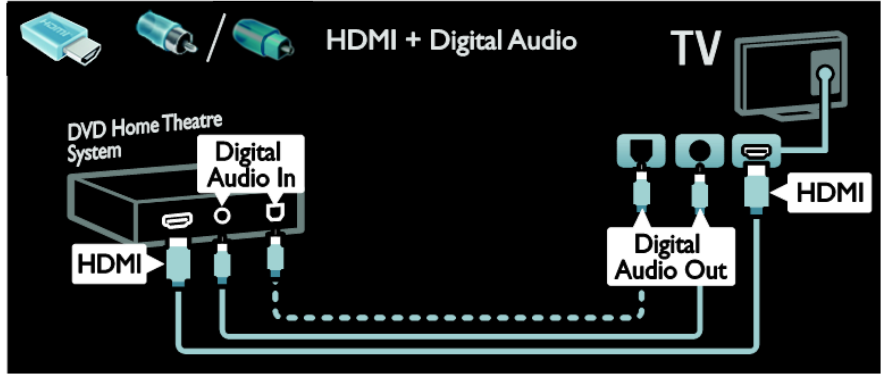

Connect the home theater with a SCART cable to the TV.

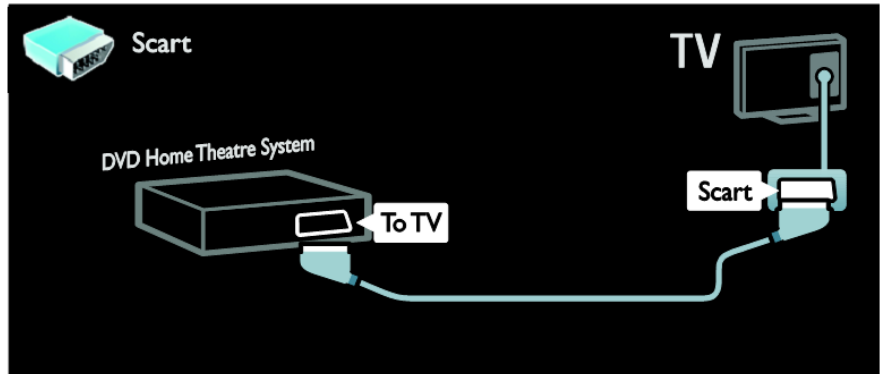

Connect the home theater with a component cable (Y Pb Pr) and an audio L/R cable to the TV.

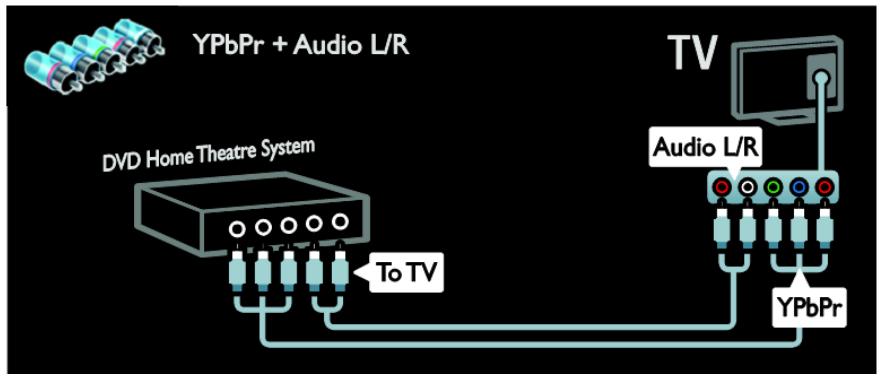

Digital camera

Connect the digital camera with a USB cable to the TV.

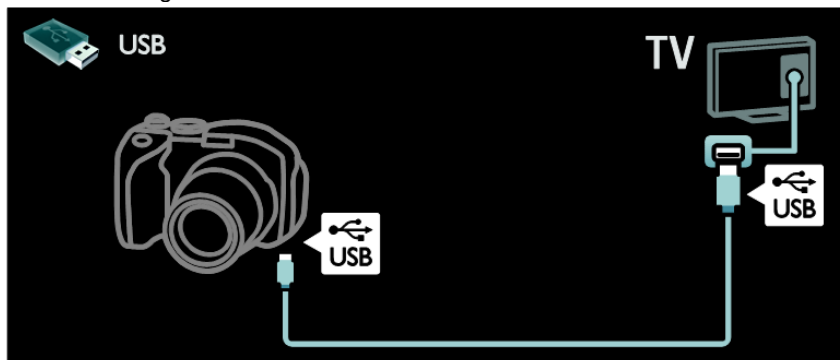

Digital camcorder

Connect the digital camera with a HDMI cable to the TV.

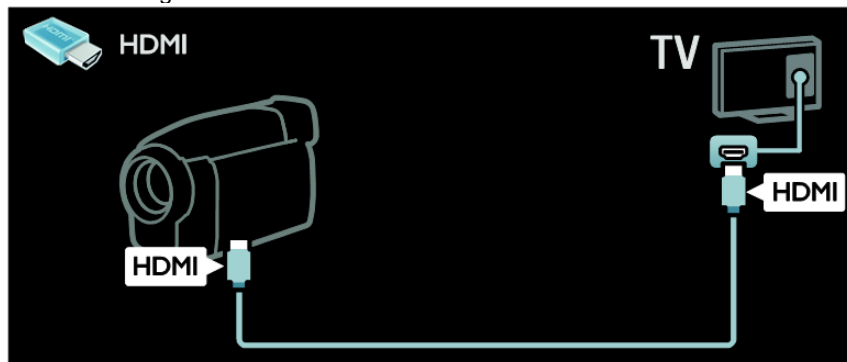

Connect the digital camcorder with a component cable (Y Pb Pr) and an audio L/R cable to the TV.

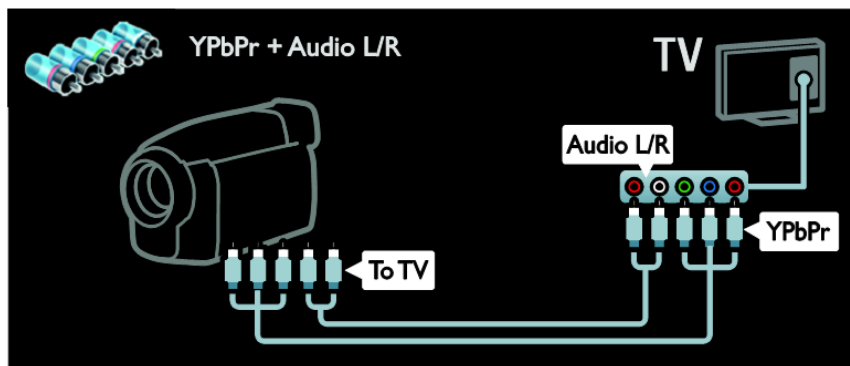

Connect more devices

External hard disk

Connect the external hard disk with a USB cable to the TV.

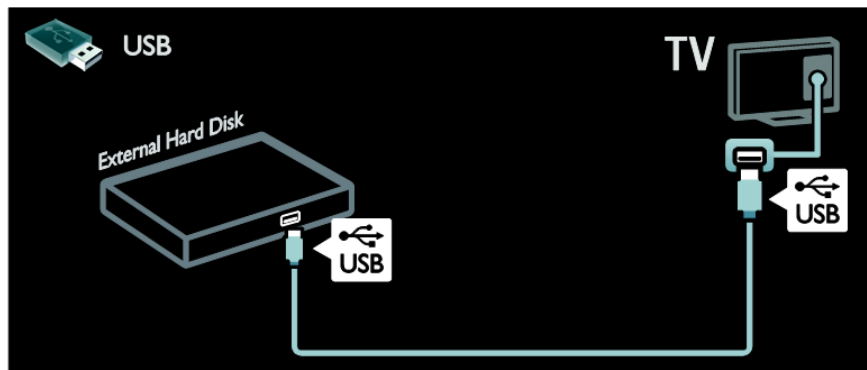

Computer

Connect the computer with a HDMI cable to the TV.

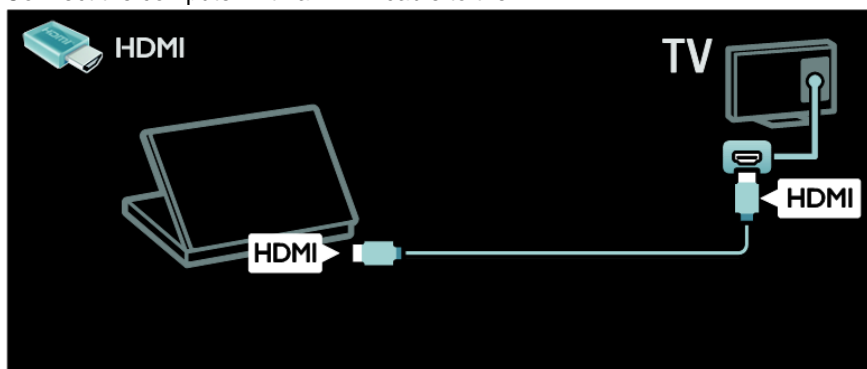

Connect the computer with a DVI-HDMI cable to the TV.

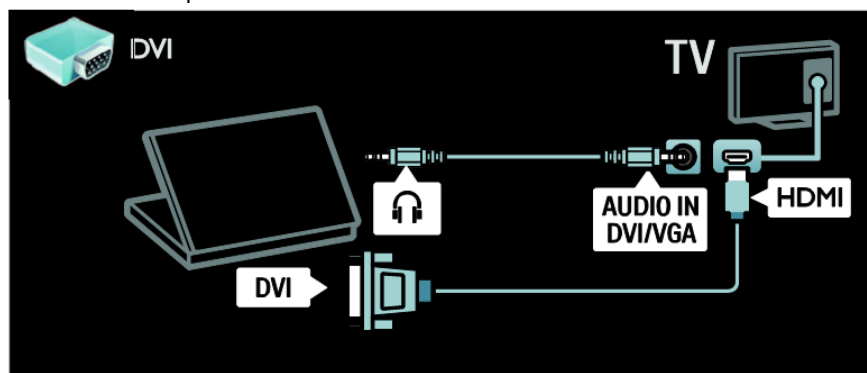

Connect the computer with a VGA cable and an audio cable to the TV.

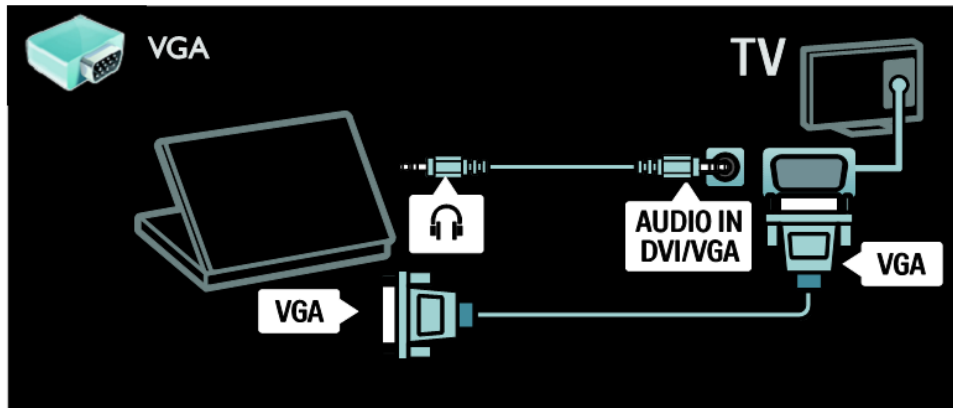

Computers and the Internet

What you can do

Network benefits

If you connect your TV to a computer network with Internet access, you can access Net TV content. For more information about Net TV, see **Use your TV > Browse Net TV** (Page 15).

Note: If the apparatus does not recover in DLNA mode due to external electrical disturbances (e.g. electrostatic discharge), user intervention is required.

What you need

Warning: This TV complies with the EMC directive only when you use a shielded Cat5 ethernet cable.

To connect your TV to computers, the Internet, or both, you need:

- An ethernet cable that is shorter than 3 meters.
- A computer network that includes:
 - a) A universal plug-and-play (UPnP) router and
 - b) A computer with one of these operating systems: Microsoft Windows XP, Microsoft Windows Vista, Mac OSX, or Linux.
- To connect your TV to the Internet, you also need a high-speed connection to the Internet.

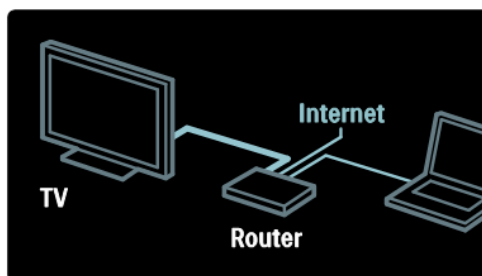

1. Switch on the router and switch on its DHCP setting.
2. With the ethernet cable, connect the router to the TV.

Alternatively, you can also connect the router to the TV wirelessly, through a wireless USB adaptor (not included). See **Connect your TV > Computers and the Internet > Wireless LAN ready** (Page 45).

3. Press **⬆**, select **[Setup] > [Connect to network]**, then press **OK**.
4. Follow the onscreen instructions to install the network.
5. Wait for the TV to find the network connection.
6. If you are prompted, agree to the End User License Agreement.

Wireless LAN ready

This TV is Wireless LAN ready. With the Wireless LAN adapter PTA01 accessory (sold separately), you can connect the TV to your home network wirelessly.

You can enjoy the best of the web from Net TV services, and sharing of content between your devices connected to the home network using Wi-Fi MediaConnect or DLNA, seamlessly and hassle free.

Note: The wireless network operates in the same 2.4GHz frequency spectrum as common household devices, such as Dect phones, microwave ovens or Bluetooth devices, which can cause Wi-Fi interferences. Move these devices away from the TV with the connected Wireless USB adapter.

you should turn off any unused network equipment in the home network as this increases network traffic.

Reception quality is dependent on the location of the wireless router, as well as the quality of services provided by the local Internet Service Provider.

When playing video over your wireless home network, we recommend that you use an IEEE 802.11 N router. The connection speed may differ according to the operating environment of your wireless home network.

Make your TV wireless

1. Switch on your wireless network router.
2. Insert the USB adapter PTA01 into the USB connection at the side of the TV. The wireless installation starts automatically
3. Follow the on screen instructions.

WPS -Wi-Fi Protected Setup

If your router supports WPS (Wi-Fi Protected Setup), press the WPS button on the router. Return to the TV in 2 minutes, select [WPS] and press OK. The TV connects to your network. This takes about 2 minutes. Complete the installation.

Most new wireless routers have the WPS system and carry the WPS logo. The WPS system uses WPA security encryption and cannot be combined with devices on your network that use the WEP security encryption. If you still need this WEP device in your network, install with [Scan] > [Custom].

Scan for routers

If you have several routers in your network, you can select the network you need. To select a specific network router, press [Scan] on the first page of the installation.

The routers with WPS and the strongest signal are shown first in the list on screen.

Select the router you need. If you are connecting a WPS router, select [WPS] at the TV.

- If you have set the PIN code in your router software, select [WPS pincod:] and enter the code.
- To enter the encryption key manually, select [Custom] and enter the key.

PIN code

To set the secured connection with a PIN code, select the PIN code and press OK.

Write down the 8 digit PIN code shown on TV and enter it in the router software on your PC. See the router manual on where to enter the PIN code.

Custom

To enter the encryption key (the security key) manually, select [Custom] and press OK. If you have WPA security on your router, enter the passphrase with the remote control.

To access the on-screen keyboard, select the text entry field and press OK. If you have WEP security encryption, the TV asks for the WEP encryption key in hexadecimal numbers.

Find this hexadecimal key in the router software on your PC. Write down the first key of the WEP keys list and enter it on TV with the remote control. If the security key is accepted, the TV is connected with the wireless router.

If asked, agree to the End User License Agreement.

If you are using the Wireless USB adapter, keep it connected to the USB connector on the TV.

Common interface

What you can do

To watch some digital TV programs, you need a Conditional Access Module (CAM).

If a CAM is inserted and subscription fees are paid, you can watch the channel. The applications, functions, the content and the onscreen messages vary for each CAM service.

What you need

Caution: To protect the CAM from damage, insert the CAM according to these instructions.

Notes:

- This TV supports CI as well as CI+. CI+ allows service providers to offer premium HD digital programs with a high level of copy protection.
- Refer to the documentation from your service operator on how to insert a smart card into the Conditional Access Module.

1. Switch off the TV.
2. Follow the directions printed on the CAM and insert the CAM into the Common Interface at the side of the TV.
3. Push the CAM in as far as it will go, then wait for the CAM to be activated. This takes a few minutes.

To prevent digital services from being deactivated, do not remove the CAM from the slot when it is in use.

Watch CAM services

1. After inserting and activating the CAM, press **OPTIONS**
2. Select [**Common interface**], then press **OK**
3. Select the CAM provider and press **OK**

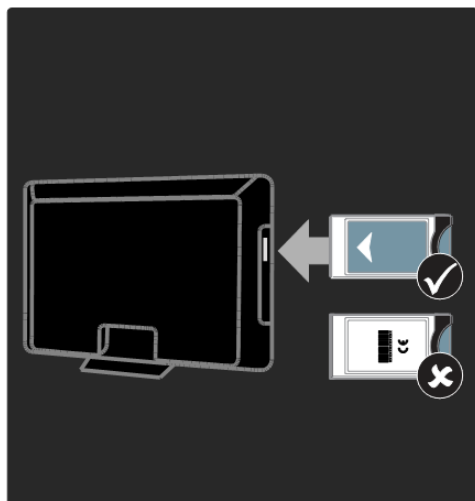

8. Troubleshooting

Contact Philips

Warning: Do not attempt to repair the TV yourself. This may cause severe injury, irreparable damage to your TV or void your warranty.

If you cannot resolve your problem, refer to the frequently asked questions (FAQs) for this TV at www.philips.com/support.

You can also contact Philips Consumer Care in your country for support. You can find the contact number in the leaflet that accompanies the TV.

Take a note of your TV model and serial number before you contact Philips. These numbers are printed on the back of the TV and on the packaging.

General TV

The TV does not switch on:

- Disconnect the power cable from the power outlet. Wait for one minute then reconnect it.
- Make sure that the power cable is securely connected.
- Make sure that the **power switch** at the base or back of the TV is switched on.

The TV does not respond to remote control or front controls when switched on

The TV requires some time to start up. During this time, the TV does not respond to the remote control or front controls. This is normal behavior.

The standby light on the TV blinks red:

Disconnect the power cable from the power outlet. Wait until the TV cools down before you reconnect the power cable. If the blinking reoccurs, contact Philips Consumer Care.

You forgot the code to unlock the child lock feature:

Enter '8888'

The TV menu is in the wrong language:

Change the TV menu to your preferred language.

For more information, see Set up your TV > PBS Setup > PBS Setup menu language (Page 22).

When you are turning the TV on, off or to standby, you hear a creaking sound from the TV chassis:

No action is required. The creaking sound is due to the normal expansion and contraction of the TV as it cools and warms up. This does not affect performance.

When the TV is in standby, a startup splash screen is displayed, then returns to standby mode:

This is normal behavior. When the TV is disconnected and reconnected to the power supply, the startup screen is displayed at the next startup.

To switch on the TV from standby, press  on the remote control or press any key on the front of the TV.

TV channel

Previously installed channels do not appear in the channel list:

Make sure that the correct channel list is selected.

No digital channels were found during the installation:

- Make sure that the TV supports DVB-T, DVB-C in your country.
- Make sure that the antenna is properly connected and the correct network is selected.

Picture

The TV is on, but there is no picture or the picture is distorted:

- Make sure that the antenna is properly connected to the TV.
- Make sure that the correct device is selected as the display source.
- Make sure that the external device or source is properly connected.

There is sound but no picture:

Make sure that the picture settings are set correctly.

There is poor TV reception from an antenna connection:

- Make sure that the antenna is properly connected to the TV.
- Loud speakers, unearthed audio devices, neon lights, high buildings, and other large objects can influence reception quality. If possible, try to improve the reception quality by changing the antenna direction or moving devices away from the TV.
- If reception on only one channel is poor, fine-tune this channel.

There is poor picture quality from connected devices:

- Make sure that the devices are connected properly.
- Make sure that the picture settings are set correctly.

The TV did not save your picture settings:

Make sure that the TV location is set to **Home**. You can change and save settings in this mode.

The picture does not fit the screen; it is too big or too small:

Try a different picture format.

The picture position is incorrect:

Picture signals from some devices may not fit the screen correctly. Check the signal output of the device.

The picture from broadcasts is scrambled:

You may need a Conditional Access Module to access content. Check with your service operator.

The computer display on the TV is not stable:

- Make sure that your PC uses the supported resolution and refresh rate. See **Product specifications > Display resolutions** (Page 50).
- Set the TV picture format to **[Unscaled]**.

Sound

There is picture but no sound from the TV:

If no audio signal is detected, the TV automatically switches the audio output off --this does not indicate malfunction.

- Make sure that all cables are properly connected.
- Make sure that the volume is not muted or set to zero.
- Make sure that the TV speakers setting is selected. Press **ADJUST**, select **[Speakers]**, and then select TV.
- Make sure that the TV audio output is connected to the audio input on the HDMI-CEC enabled or EasyLink compliant home theater device. Sound should be heard from the home theater speakers.

There is picture but sound quality is poor:

Make sure that the sound settings are correctly set.

There is picture but sound comes from one speaker only:

Make sure that sound balance is set to the center.

HDMI

There are problems with HDMI devices:

- Note that HDCP (High-bandwidth Digital Content Protection) support can delay the time taken for a TV to display content from a HDMI device.
- If the TV does not recognize the HDMI device and no picture is displayed, switch the source from one device to another and back again.
- If there are intermittent sound disruptions, make sure that output settings from the HDMI device are correct.
- If you use an HDMI-to-DVI adapter or HDMI to DVI cable, make sure that an additional audio cable is connected to AUDIO L/R or AUDIO IN (mini-jack only).

You cannot use EasyLink features:

Make sure that your HDMI devices are HDMI-CEC compatible. EasyLink features only work with devices that are HDMI-CEC compatible.

If a HDMI-CEC compliant audio device is connected to the TV and the TV does not display any mute or volume icon when the volume is muted, increased or decreased.

This behavior is normal when a HDMI-CEC audio device is connected.

USB

USB device content is not displayed:

- Make sure that the USB storage device is set to Mass Storage Class compliant, as described in the storage device's documentation.
- Make sure that the USB storage device is compatible with the TV.
- Make sure that the audio and picture file formats are supported by the TV.

Audio and picture files do not play or display smoothly:

The transfer performance of the USB storage device may limit the data transfer rate to the TV which causes poor playback.

Network

Net TV does not work

If the connection to the router is properly set up, check the router connection to the Internet.

Browse PC or Net TV access is slow.

Refer to your router's user manual for information on transfer rate and other factors of signal quality.

You need a high-speed Internet connection for your router.

Wireless network is distorted or not found.

- Make sure that the wireless network is not disturbed by microwave ovens, DECT phones, or other neighboring Wi-Fi devices.
- If the wireless network is not working, try a wired network connection.
- For DLNA connection, click on **How does sharing change firewall settings** in the **Media Sharing** window for the Help file

9. Product specifications

Power and reception

Product specifications are subject to change without notice. For more specification details of this product, see www.philips.com/support

Power

- Mains power: AC 220-240 V~, 50-60 Hz
- Standby power: ≤ 0.15 W
- Ambient temperature: 5 to 40 degree Celsius

The power rating stated on the product typeplate is the power consumption for this product during normal household use (IEC 62087 Ed.2). The maximum power rating, stated between brackets, is used for electrical safety (IEC 60065 Ed. 7.2).

Reception

- Antenna input: 75 ohm coaxial (IEC75)
- TV system: DVB COFDM 2K/8 K,
- Video playback: NTSC, PAL, SECAM
- Digital TV: MPEG-4, DVB-T (Terrestrial), *DVB-T2, DVB-C (Cable).
- Tuner bands: VHF, UHF, S-Channel, Hyperband

Display and sound

Picture / Display

- Display type: LCD Full HD W-UXGA
- Diagonal size:
 - 81 cm / 32 inch
 - 94 cm / 37 inch
 - 102 cm / 40 inch
 - 117 cm / 46 inch
 - 140 cm / 55 inch
- Aspect ratio: Widescreen 16:9
- Panel resolution: 1920 x 1080 p
- Pixel Plus HD picture enhancement
- 1080 p 24 / 25 / 30 / 50 / 60 Hz processing
- Perfect Motion Rate 400 Hz PMR

Sound

- Output power (RMS) @ 30% THD:
 - 32 to 40-inch models: 24 W
 - 46 to 55-inch models: 28 W
- Incredible Surround
- Clear Sound
- Dynamic Bass Enhancement
- Mono / Stereo / NICAM

Display resolutions

Computer formats – HDMI (Resolution - refresh rate)

640 x 480 - 60 Hz
800 x 600 - 60 Hz
1024 x 768 - 60 Hz
1280 x 1024 - 60 Hz
1360 x 768 - 60 Hz
1600 x 1200 - 60 Hz
1920 x 1080 - 60 Hz

Computer formats - VGA (Resolution - refresh rate)

640 x 480 - 60 Hz
800 x 600 - 60 Hz
1024 x 768 - 60 Hz
1280 x 1024 - 60 Hz
1360 x 768 - 60 Hz
1600 x 1200 - 60 Hz
1920 x 1080 - 60 Hz

Video formats (Resolution - refresh rate)

480i - 60 Hz
480p - 60 Hz
576i - 50 Hz
576p - 50 Hz
720p - 50Hz, 60 Hz
1080i - 50Hz, 60 Hz
1080p - 24Hz, 25Hz, 30Hz, 50Hz, 60 Hz

Multimedia

Supported multimedia connections

- Multimedia file names must not exceed 128 characters.
- USB (FAT or DOS-formatted; Mass Storage Class compliant of 500mA only)
- Ethernet UTP5

Supported image files

- JPEG (*.jpg)

Supported audio/video files

File Extension	Container	Video Codec	Resolution	Frame Rate (fps)	Bit Rate (Mbps)	Audio Codec	USB	DLNA	Net TV	Open Internet	Video Store
.avi	AVI	MPEG4 SP	640x480p	30	3	AAC	Yes	Yes	No	No	No
		MPEG4 ASP	720x576p	30	8	MP3/MPEG1 L2/ AC3	Yes	Yes	No	No	No
.mkv	MKV	H.264	1920x1080p	24	20	HE-AAC, AC3, MP3, PCM	Yes	Yes	No	No	No
.asf .wmv	ASF	WMV9/VC1 SP	352x288p	15	0.384	WMA	Yes	Yes	Yes	No	Yes
		WMV9/VC1 MP	1920x1080p	25/30	20	WMA	Yes	Yes	Yes	No	Yes
		WMV9/VC1 AP	1920x1080p	24/30/60	20	WMA	Yes	Yes	Yes	No	Yes
.mp4	MP4	H.264 BP	720x576i	15/30	5	AAC/HE-AAC (1&2)/AC3	Yes	Yes	Yes	No	Yes
		H.264 MP	720x576i	15/30	10	AAC/HE-AAC (1&2)/AC4	Yes	Yes	Yes	No	Yes
		H.264 HP	1920x1080i	15/30	20	AAC/HE-AAC (1&2)/AC5	Yes	Yes	Yes	No	Yes
		MPEG4 SP	640x480p	30	3	AAC	Yes	Yes	Yes	No	Yes
		MPEG4 ASP	720x576i	30	8	AAC	Yes	Yes	Yes	No	Yes

File Extension	Container	Video Codec	Resolution	Frame Rate (fps)	Bit Rate (Mbps)	Audio Codec	USB	DLNA	Net TV	Open Internet	Video Store
.ts	TS	MPEG2	1920x1080p	30	20	MPEG2 L2/MPEG1	Yes	Yes	No	No	No
.mpg .mpeg .vob	PS	MPEG2	1920x1080p	30	20	MPEG2 L2/ MPEG1 L2/AC3 LPCM1	Yes	Yes	No	No	No
		MPEG1	352x288	30	1.5	MPEG1 L2	Yes	Yes	No	No	No

Connectivity

Rear

- EXT 1 (RGB/CVBS): SCART
- EXT 2: Component video (Y Pb Pr), Audio (L/R)
- SERV.U: Service port
- AUDIO IN: DVI/VGA stereo 3.5mm mini-jack

Bottom

- Network: Ethernet
- DIGITAL AUDIO OUT: Optical
- HDMI 2: HDMI
- HDMI 1 ARC: HDMI Audio Return Channel
- AUDIO IN: DVI/VGA stereo 3.5mm mini-jack
- Antenna: 75 ohm coaxial
- VGA: PC input

Side

- CI: Common Interface
- USB
- HDMI

Dimensions

Note:Dimensions and weights are approximate values only. Design and specifications are subject to change without notice.

Legend for TV dimensions

The legends used to indicate the TV dimensions are as follows:

- () : 81 cm / 32 inch TV
- { } : 94 cm / 37 inch TV
- [] : 102 cm / 40 inch TV
- (()) : 117 cm / 46 inch TV
- {{ }} : 140 cm / 55 inch TV

Take a note of the legend that corresponds to your TV. Then, go to the next page to view the dimensions.

Use your TV legend to note the weight of the TV without the stand.

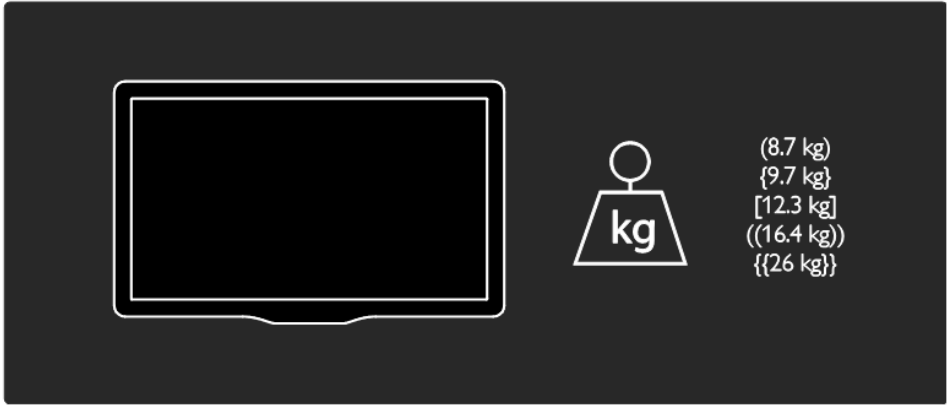

Use your TV legend to note the weight of the TV with stand.

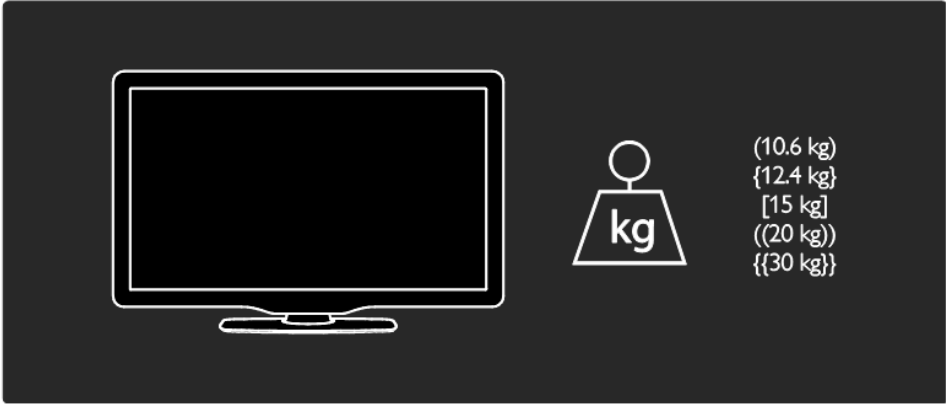

Use your TV legend to note the dimensions of your TV (with and without the stand).

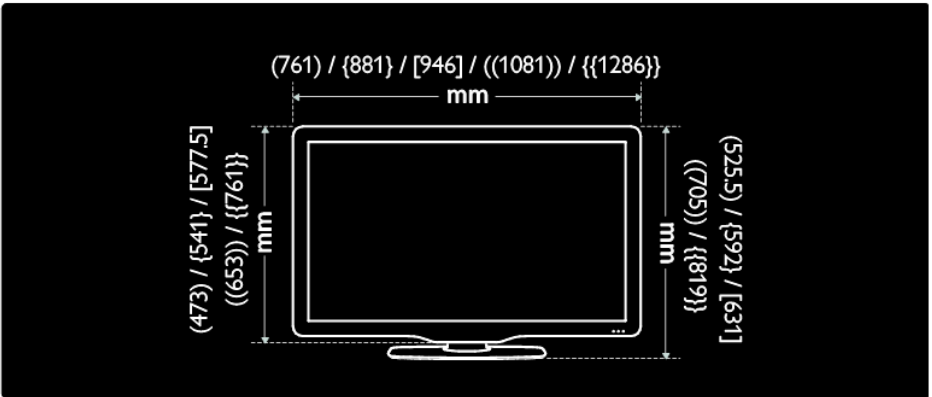

Use your TV legend to note the thickness of your TV (with and without the stand).

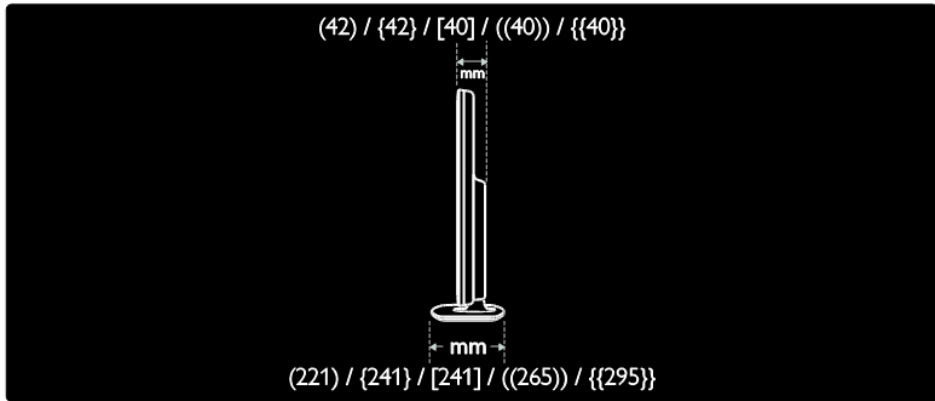

Use a Kensington lock

There is a Kensington security slot at the back of the TV. Prevent theft by looping a Kensington lock between the slot and a permanent object, such as a heavy table.

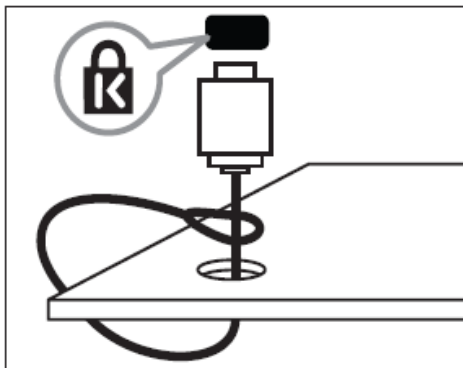

10.Index

A		Dimensions	67
analog channels, fine-tune	61	display	65
analog channels, subtitles	22	display resolution	65
audio language	40	DLNA	56
C		E	
CAM, enable	59	EasyLink controls	14
CAM, insert	59	EasyLink, enable	23
care	3	EasyLink, features	23
channel list	12	EasyLink, TV speakers	24
channels, fine-tune (analog)	40	Electronic Program Guide	15
channels, install (automatic)	41	EPG, Electronic Programme Guide	15
channels, install (manual)	41	EPG, menu	15
channels, reinstall	39	F	
channels, rename	43	factory settings	34
channels, reorder	43	H	
channels, switch	14	HDMI	62
channels, update	41	HDMI ARC	46
Child lock	42	hearing impaired	39
Clock	21	high-definition (HD), content	10
Common interface	59	home menu	8
computer, play files	16	home mode	8
computer, see PC	56	I	
Conditional Access Module	59	install channels	41
connect device	48	install channels (automatic)	41
connect, PC	55	install channels (manual)	41
connect, USB	55	K	
connectors	46	kensington lock	69
contact information, on Internet	60	L	
contact Philips	60	language, menu	28
controls	12	M	
D		multimedia	66
demo	10	multimedia, play files	16
devices, add	9	mute TV speakers	15
devices, watch	16		
digital channels	22		
digital channels, subtitles	22		

N		software, digital update	44
Net TV, browse	18	software, Internet update	45
		software, version	44
P		sound settings	36
PC, connect	55	subtitle, analog	22
PC, display resolutions	65	subtitle, digital	22
picture format	28	subtitle, language	22
picture settings	35	switch TV on, off	14
Pixel Plus link	23		
placement, stand or wall mount	38	T	
position the TV	38	teletext 2.5	21
power	31	teletext, digital text	21
		teletext, dual screen	20
R		teletext, enlarge	20
reinstall TV	39	teletext, language	20
remote control	8	teletext, search	20
remote control, batteries	13	teletext, subpages	20
remote control, onscreen	12		
remote control, overview	12	U	
rename channels	43	universal access, enable	38
reorder channels	43	universal access, hearing impaired	39
		universal access, visually impaired	39
S			
safety	5	V	
Scene+, enable	29	visually impaired	39
settings, assistant	35	volume	15
settings, picture	35		
settings, sound	36	W	
sleeptimer	37	wall mount	5
smart picture	15	wallpaper	18
smart sound	16	Wi-Fi MediaConnect	57
Smart USB	17	Wireless LAN ready	57



© 2012 Koninklijke Philips Electronics N.V.
All rights reserved.