

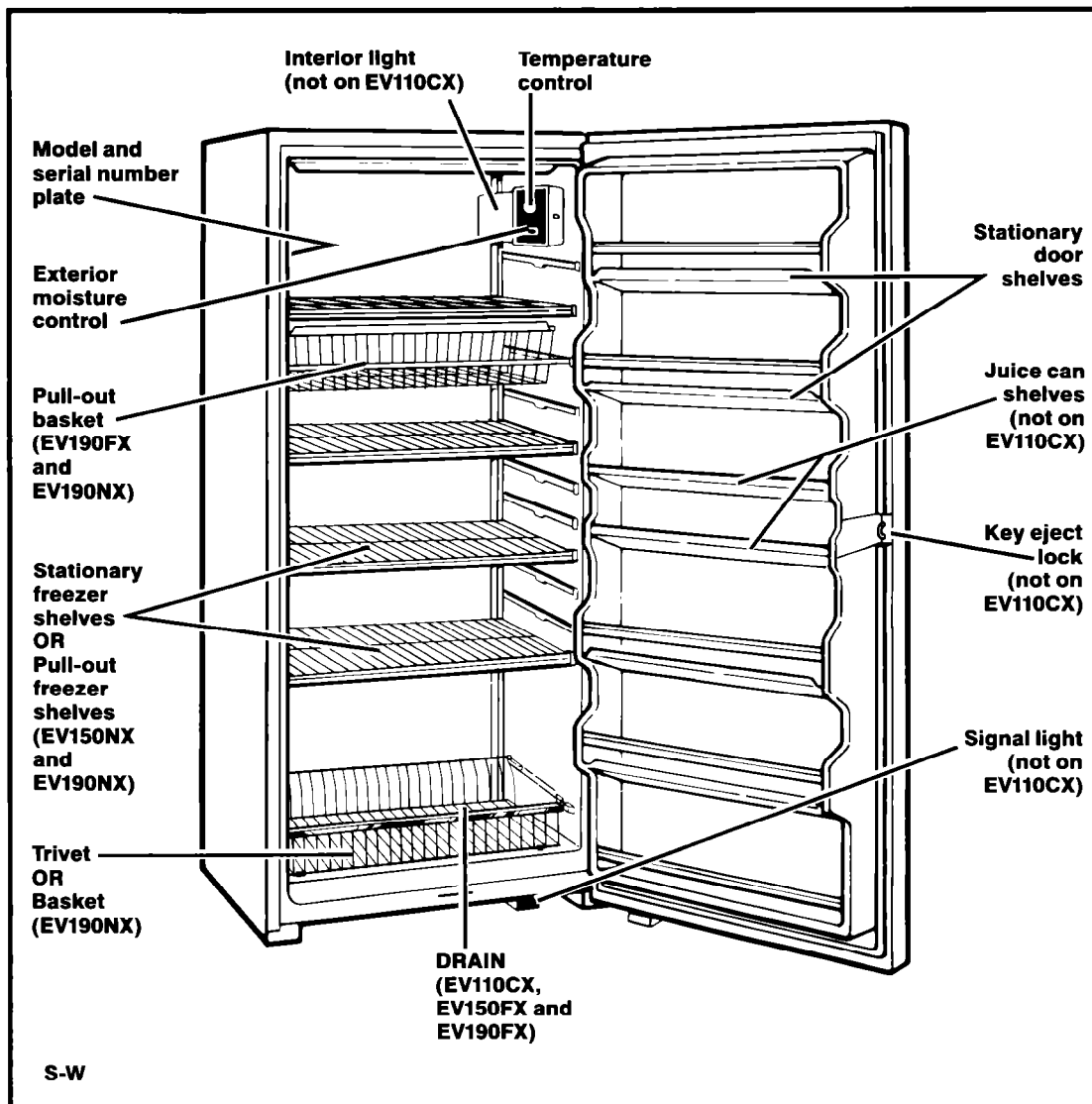

Use & Care Guide



UPRIGHT FREEZERS

EV110CX EV150FX EV150NX EV190FX EV190NX

Contents

	Page
Important Safety Instructions	3
Installing Your Freezer	4
Using Your Freezer	5
Setting the temperature control	5
Adjusting the temperature control	5
Cooling freezer first	5
Exterior moisture control	5
The pull-out basket	5
The trivet	6
The freezer basket	6
The key eject lock	6
Replacing the light bulbs	6
Cleaning Your Freezer	8
Cleaning manual defrost models	8
Cleaning frost-free models	8
Cleaning the condenser coils	8
Caring For Your Freezer	9
If electricity goes off	9
Moving	9
If You Need Service Or Assistance	10
Whirlpool Domestic Freezer Warranty ..	12

©1990 Whirlpool Corporation

Remove the Consumer Buy Guide Label, tape and any inside labels before using the freezer.

To remove any remaining glue:

- Rub briskly with thumb to make a ball then remove.

OR

- Soak area with liquid hand dishwashing detergent before removing glue as described above.

Do not use sharp instruments, rubbing alcohol, flammable fluids or abrasive cleaners. These can damage the material. See "Important Safety Instructions" on page 3.

NOTE: Do not remove the Tech Sheet fastened under the freezer at the front.

Thank you for buying a Whirlpool appliance.

Please complete and mail the Owner

Registration Card provided with this product. Then complete the form below. Have this information ready if you need service or call with a question.

- Copy model and serial numbers from plate (see diagram on front cover) and purchase date from sales slip.
- Keep this book and sales slip together in a handy place.

Model Number

Serial Number

Purchase Date

Service Company Phone Number

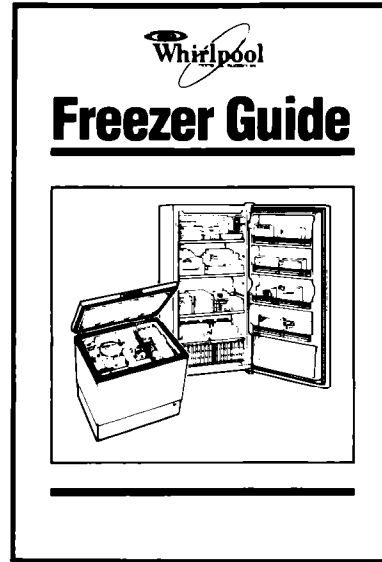

Whirlpool Freezer Guide for your freezer.

The Whirlpool Freezer Guide is a companion book to this Freezer Use and Care Guide and is available free of charge. It contains information on freezing different kinds of foods, packaging, and food storage times. The Freezer Guide also has helpful hints for saving energy and solving common freezer problems.

To order the Freezer Guide, write to:

Whirlpool Corporation
Attention: Customer Service Dept.
1900 Whirlpool Drive
LaPorte, IN 46305

and request the Whirlpool Freezer Guide,
Part No. 1114865.

Important Safety Instructions

⚠ WARNING

To reduce the risk of fire, electrical shock, or injury when using your freezer, follow basic precautions including the following:

- **Read all instructions before using the freezer.**
- **Child entrapment and suffocation are not problems of the past. Junked or abandoned freezers are still dangerous...even if they will "just sit in the garage a few days."**
If you are getting rid of your old freezer, do it safely. Please read the enclosed safety booklet from the Association of Home Appliance Manufacturers. Help prevent accidents.
- **Never allow children to operate, play with, or crawl inside the freezer.**
- **Never clean freezer parts with flammable fluids. The fumes can create a fire hazard or explosion.**

• **FOR YOUR SAFETY** •

DO NOT STORE OR USE GASOLINE OR OTHER FLAMMABLE VAPORS AND LIQUIDS IN THE VICINITY OF THIS OR ANY OTHER APPLIANCE. THE FUMES CAN CREATE A FIRE HAZARD OR EXPLOSION.

It is your responsibility to be sure your freezer:

- is installed and leveled on a floor that will hold the weight, and in an area suitable for its size and use.
- is connected only to the right kind of outlet, with the right electrical supply and grounding. (Refer to the Electrical Requirements and Grounding Instructions Sheet.)
- is used only to do what home freezers are designed to do.
- is not near an oven, radiator or other heat source.
- is properly maintained.
- is out of the weather.
- is used in an area where the temperature will not exceed 110°F (43.3°).
- is not used by anyone unable to operate it properly.
- is not loaded with food before it has time to get properly cold.

– **SAVE THESE INSTRUCTIONS** –

Installing Your Freezer

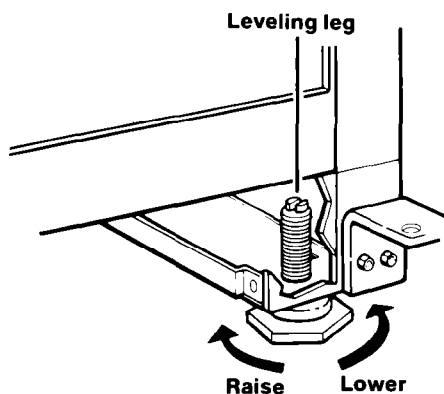
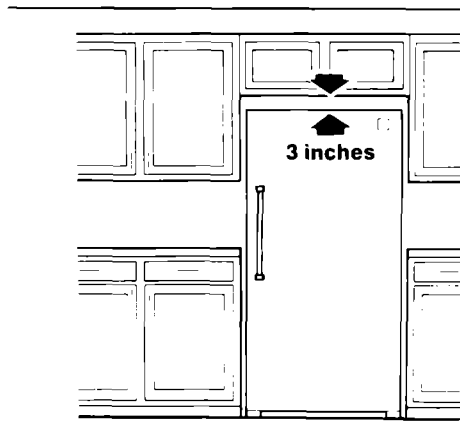
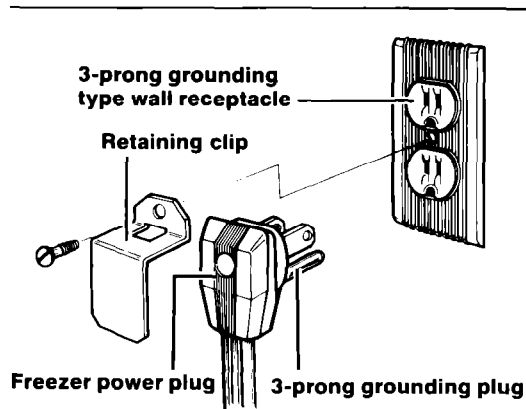

1. Clean it

Clean your freezer before using it.

1. Use a sponge, cloth or paper towel and mild detergent in warm water to clean outside and inside of freezer, door liner and gasket.
2. Rinse and dry thoroughly.

2. Plug it in

Recommended Grounding Method

A 115 Volt, 60 Hz., AC only 15 or 20 ampere fused and properly grounded electrical supply is required. It is recommended that a separate circuit serving only this appliance be provided. Use a receptacle which cannot be turned off with a switch or pull chain. Do not use an extension cord.

Attach retaining clip, from literature pack inside the freezer, over power cord plug. See Electrical Requirements and Grounding Instruction Sheet in your Literature Package.

3. Install properly

1. Pick a safe place, indoors, away from flammables such as gasoline.
2. Check the strength of the floor. It should hold the weight of a fully loaded freezer.
3. Allow at least 3 inches (7.5 cm) air space on top of freezer and 1 inch (2.5 cm) at back. Allow $\frac{1}{2}$ inch (1.25 cm) on each side of the freezer for ease of installation.
4. If the freezer is to be against a wall, you might want to leave extra space on the hinge side so the door can be opened wider.

4. Level freezer

Level freezer so the door will stay open at any position.

1. Depending on model, freezer comes with either 4 bolts that hold freezer in shipping crate or 2 threaded leveling legs.

NOTE: The 2 threaded leveling legs are shipped in a separate package.

2. Screw 4 bolts all the way into bolt holes in the bottom corners of freezer. Screw 2 leveling legs all the way into bolt holes in the bottom front corners of freezer.
3. Slide freezer into place.
4. For models with 4 bolts, adjust each leg until the freezer won't rock.
5. Adjust front legs to level the freezer.
 - To raise corners, turn legs in direction shown.
 - To lower corners, turn legs in direction shown.
6. Check with level.
7. After freezer is fully loaded, recheck with level.

Using Your Freezer

The drawings in this book may vary slightly from your freezer model. They are designed to show the different features of all the models covered by this book.

NOTE: Your model may not include all the features shown.

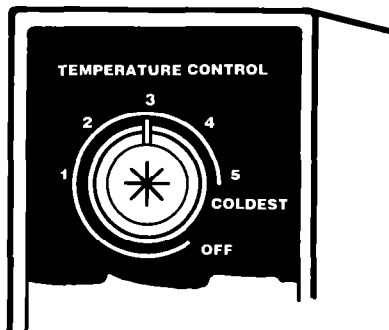

Setting the temperature control

- Turn control to the middle of the dial. This setting is designed to maintain the temperature at or near 0°F (- 17.8°C) under normal operating conditions.

Adjusting the temperature control

- Turn control to higher number for colder temperatures.
- Turn to lower number for less cold temperatures.

Cooling freezer first

1. Allow freezer to cool 6 to 8 hours before filling with **frozen food**.
2. Let it cool overnight before adding large amount of **unfrozen food**. Never add more than 2-3 pounds of unfrozen food per cubic foot of freezer size.

NOTE: When freezer is first started, the compressor will run constantly until the cabinet is cooled. It may take up to 6 to 8 hours or longer, depending on room temperature and the number of times the freezer door is opened.

After the cabinet is cooled, the compressor will turn on and off as needed to keep freezer at proper temperature.

Exterior moisture control

The Exterior Moisture Control operates electric heaters around the door openings. These heaters help keep moisture from forming on the outside of the freezer.

1. Use the OFF setting when humidity is low.
2. Use the ON setting if moisture forms on the outside of the refrigerator.

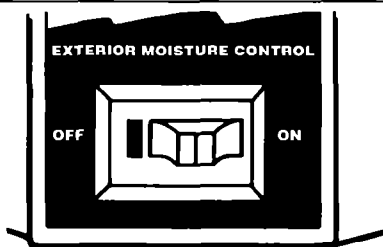

The pull out basket (EV190FX and EV190NX)

Store small packages in basket to avoid losing them in freezer.

To remove:

1. Remove food from basket.
2. Slide basket out to the stop.
3. Lift front.
4. Slide the rest of the way out.

To replace:

1. Fit back of basket on top of guide stops on bottom of guides.
2. Lift front, then slide the basket until it clears the guide stops.

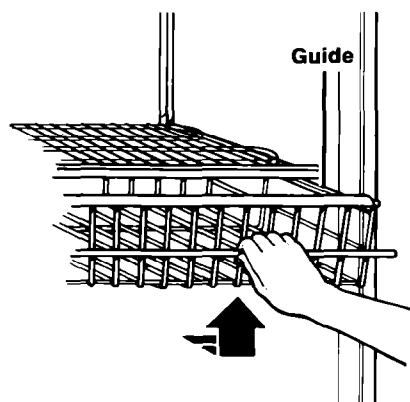

Using Your Freezer Continued

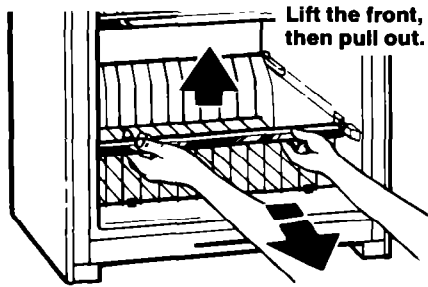

The trivet

(EV110CX, EV150FX and EV150NX)

Always use trivet in order to maintain proper air circulation.

To remove:

1. Lift front of trivet out of supports.
2. Pull out.

To replace:

1. Position back of trivet on the rear wall supports.
2. Lower front into place.

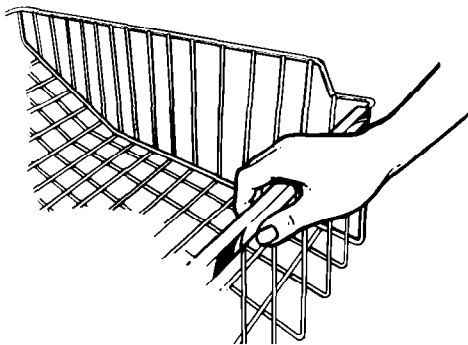

The freezer basket

(EV190NX)

Always use basket in order to maintain proper air circulation.

To remove:

1. Slide out to the stop.
2. Lift the front to clear the stop.
3. Slide out the rest of the way.

To replace:

1. Place basket on the slides.
2. Make sure the wire stops clear the front of the slides.
3. Slide basket in the rest of the way.

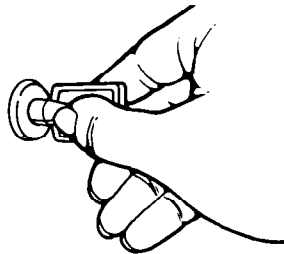

The key eject lock

(EV150FX, EV150NX, EV190FX and EV190NX)

If your freezer is equipped with a lock, it can help reduce the hazard of child entrapment.

To lock or unlock the freezer you must hold the key in the lock while turning. The lock is spring loaded so the key cannot be left in the lock.

If the key is lost, contact your Whirlpool dealer for a replacement. Always give the complete model and serial number of your freezer when requesting a replacement key.

Replacing the light bulbs

(EV150FX, EV150NX, EV190FX and EV190NX)

⚠ WARNING

Electrical Shock Hazard

Before removing a light bulb, either unplug the freezer or disconnect the electricity leading to the freezer at the main power supply. Shock and injury can occur if electricity remains connected.

To replace interior light:

1. Disconnect freezer from power supply.
2. Remove the light shield from the side of the control panel. Depress the back of the shield to release the tabs, then pull away.
3. Replace the bulb with a 40-watt appliance bulb.
4. Replace the light shield. Insert the shield tabs in the slots, then press the shield to snap into place.
5. Reconnect power supply.

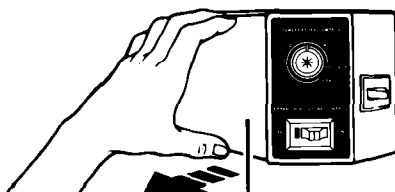

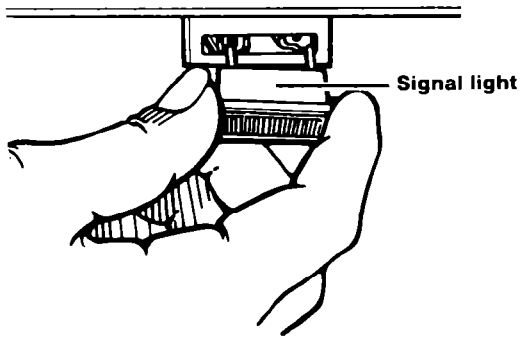

To replace signal light:

The signal light automatically warns of any unexpected power failure.

If the signal light is not glowing, immediately check for power interruption, an unplugged power cord or a burned out signal light.

1. Disconnect freezer from power supply.
2. Open the freezer door.
3. **Push out signal light from behind, then unplug burned out light. Replace with a new one. Signal light can be ordered from your Whirlpool dealer, Part No. 1103639.**
4. Close freezer door and reconnect power supply.

Cleaning Your Freezer

⚠ WARNING

Electrical Shock and Product Damage Hazard

For manual defrost models:

- **Do not place electrical devices in freezer when defrosting. Shock or injury can occur.**
- **Do not use an ice pick, knife or other sharp-pointed tool to defrost freezer. Damage can occur.**

For all models:

- **Do not use abrasive cleaners on your freezer. Do not use cleaning waxes, concentrated detergents, bleaches or cleaners containing petroleum on plastic parts. Damage can occur.**

Cleaning manual defrost models (EV110CX, EV150FX and EV190FX)

Defrost and clean your freezer when frost has built up to about ¼ inch (6 mm) thickness. Complete defrosting and cleaning should be done at least once a year. In high humidity areas, a freezer may need more frequent defrosting and cleaning.

1. Turn Temperature Control to OFF and unplug power cord.
2. Remove all frozen food. Wrap frozen food in several layers of newspaper and cover with a blanket. Food will stay frozen for several hours.

OR

Store frozen food in a cooler, additional refrigerator-freezer, or in a cool area.

3. Place a shallow pan (sides no higher than 1 inch) on floor, centered under drain hole in bottom of freezer.
4. Place pans of hot water in freezer with door open to speed melting. Directing air from an electric fan into freezer will also help. Do not place fan in freezer.
5. Use a plastic scraper to remove frost.
6. Wipe water from walls with a towel or sponge.
7. Wash the inside walls with a solution of 2 tablespoons (26 g) baking soda to 1 quart (0.95 L) warm water.
8. Rinse and dry thoroughly.
9. Use a sponge, cloth or paper towel and mild detergent in warm water to clean outside of freezer, door liner and gasket.
10. Rinse and dry thoroughly.
11. Clean the condenser coils on back of the freezer. See "Cleaning the condenser coils" section on this page.

12. Wax painted metal surfaces outside of freezer to provide rust protection.

NOTE: Do not use wax on plastic parts; wax may damage them.

13. Replace all frozen food.
14. Plug in freezer and refer to "Setting the temperature control" on page 5.

Cleaning frost-free models (EV150NX and EV190NX)

Complete cleaning should be done at least once a year.

1. Turn Temperature Control to OFF and unplug power cord.
2. Remove all frozen food. Wrap frozen food in several layers of newspaper and cover with a blanket. Food will stay frozen for several hours.

OR

Store frozen food in a cooler, additional refrigerator-freezer, or in a cool area.

3. Wash the inside walls with a solution of 2 tablespoons (26 g) baking soda to 1 quart (0.95 L) warm water.
4. Rinse and dry thoroughly.
5. Use a sponge, cloth or paper towel and mild detergent in warm water to clean outside of freezer, door liner and gasket.
6. Rinse and dry thoroughly.
7. Clean the condenser coils on back of the freezer. See "Cleaning the condenser coils" below.
8. Wax painted metal surfaces outside of freezer to provide rust protection.
NOTE: Do not use wax on plastic parts, wax may damage them.
9. Replace all frozen food.
10. Plug in freezer and refer to "Setting the temperature control" on page 5.

Cleaning the condenser coils

Clean dust and lint from condenser coils behind the freezer every two or three months.

⚠ WARNING

Personal Injury Hazard

Watch out for sharp wire ends at top of condenser coils. They can cause injury or damage brush.

1. Slide freezer out away from the wall.
2. Use a vacuum cleaner with a brush attachment to clean coils.
3. Replace freezer in original position.

Caring For Your Freezer

If electricity goes off

1. **Call the power company.** Ask how long power will be off.
2. **Keep freezer closed if service will be interrupted 24 hours or less.** This will help food stay frozen.
3. **If service is to be interrupted longer than 24 hours, do this:**
 - Remove all frozen food and store in a frozen food locker.

OR

WARNING

Personal Injury Hazard

Wear gloves to protect your hands from dry ice burns. Failure to do so could result in dry ice burns.

- Place 2 lbs. (0.9 kg) of dry ice in freezer for every cubic foot of freezer space. This will keep foods frozen for 2 to 4 days.

OR

- If dry ice or a food locker is not available, use or can perishable food at once.

NOTE: A full freezer stays colder longer than a partly filled one. A freezer full of meats stays colder longer than a freezer full of baked goods.

Food containing ice crystals may be safely refrozen, but the quality and flavor of the food may be affected.

Use refrozen food quickly. If the condition of the food is poor, or you feel it is unsafe to eat, dispose of it immediately.

Moving

If you have installed an automatic ice maker in your freezer (EV150NX), shut off ice maker water supply line a day ahead of time. Disconnect the water line. After the last supply of ice drops, lift the signal arm to turn off the ice maker. Make sure all ice crescents are dispensed out of the mechanism.

Remove all frozen food and pack it in dry ice. Unplug the freezer and clean it thoroughly.

Take out all removable parts. Wrap parts well and tape them together so they don't shift or rattle. Tape the door shut and tape the electric cord to the cabinet.

When you get to your new home, put everything back and refer to pages 4 and 5. If you have an ice maker, be sure to reconnect the water supply line.

If You Need Service Or Assistance

We suggest you follow these steps:

1. Before calling for assistance...

Performance problems often result from little things you can find and fix yourself without tools of any kind.

If freezer stops running:

- Check to see if power cord is plugged into the outlet.
- Check fuse box or circuit breaker.
- Check electric company for a power failure.
- Be sure Temperature Control is turned ON.

If motor seems to run too long:

1. If large amounts of unfrozen food have been put into the freezer, motor will run longer.
2. On hot summer days or if room is hot, motor will run longer to provide correct amount of cooling.
3. Is the condenser free of dust and lint?
4. Check to see that there is enough air circulation space above and in back of the freezer.

2. If you need assistance*...

Call Whirlpool COOL-LINE® service assistance telephone number. Dial free from anywhere in the U.S.:

1-800-253-1301

and talk with one of our trained consultants. The consultant can instruct you in how to obtain satisfactory operation from your appliance or, if service is necessary, recommend a qualified service company in your area.

If you prefer, write to:

Mr. Donald Skinner
Director of Consumer Relations
Whirlpool Corporation
2000 M-63
Benton Harbor, MI 49022

Please include a daytime phone number in your correspondence.

3. If you need service*...



Whirlpool has a nationwide network of authorized WhirlpoolSM service companies. Whirlpool service technicians are trained to fulfill the product warranty and provide after-warranty service, anywhere in the United States. To locate the authorized Whirlpool service company in your area, call our COOL-LINE® service assistance telephone number (see Step 2) or look in your telephone directory Yellow Pages under:

APPLIANCES - HOUSEHOLD - ELECTRICAL APPLIANCES -
MAJOR - SERVICE & REPAIR MAJOR - REPAIRING & PARTS
OR
WASHING MACHINES, DRYERS
& IRONERS - SERVICING
WHIRLPOOL APPLIANCES
AUTHORIZED WHIRLPOOL SERVICE
SERVICE COMPANIES
XYZ SERVICE CO . . . 999-9999
123 MAPLE . . .

4. If you need FSP® replacement parts*...

FSP is a registered trademark of Whirlpool Corporation for quality parts. Look for this symbol of quality whenever you need a replacement part for your Whirlpool appliance. FSP replacement parts will fit right and work right, because they are made to the same exacting specifications used to build every new Whirlpool appliance.

To locate FSP replacement parts in your area, refer to Step 3 above or call the Whirlpool COOL-LINE service assistance number in Step 2.

5. If you are not satisfied with how the problem was solved*...

- Contact the Major Appliance Consumer Action Panel (MACAP). MACAP is a group of independent consumer experts that voices consumer views at the highest levels of the major appliance industry.
- Contact MACAP only when the dealer, authorized servicer or Whirlpool have failed to resolve your problem.
Major Appliance Consumer Action Panel
20 North Wacker Drive
Chicago, IL 60606
- MACAP will in turn inform us of your action.

*When requesting assistance, please provide: model number, serial number, date of purchase, and a complete description of the problem. This information is needed in order to better respond to your request.

Whirlpool® Domestic Freezer Warranty

FZ003

LENGTH OF WARRANTY	WHIRLPOOL WILL PAY FOR
FULL ONE YEAR WARRANTY From Date of Purchase	FSP® replacement parts and repair labor to correct defects in materials or workmanship.
FULL TEN YEAR WARRANTY From Date of Purchase	FSP® replacement parts and repair labor to correct defects in materials or workmanship in the sealed refrigeration system. These parts are: <ol style="list-style-type: none"> 1. Compressor 2. Evaporator 3. Condenser 4. Drier 5. Connecting tubing
WHIRLPOOL WILL NOT PAY FOR	
<p>A. Service calls to:</p> <ol style="list-style-type: none"> 1. Correct the installation of the freezer. 2. Instruct you how to use the freezer. 3. Replace house fuses or correct house wiring or plumbing. 4. Replace light bulbs or batteries. <p>B. Pick up and delivery. This product is designed to be repaired in the home.</p> <p>C. Damage to freezer caused by accident, misuse, fire, flood, acts of God or use of products not approved by Whirlpool.</p> <p>D. Food loss coverage for freezers used in commercial applications.</p>	

Limited domestic food loss coverage. See below for details on limited domestic food loss protection plan. Service under the full warranties must be provided by an authorized WhirlpoolSM service company. WHIRLPOOL CORPORATION SHALL NOT BE LIABLE FOR INCIDENTAL OR CONSEQUENTIAL DAMAGES. Some states do not allow the exclusion or limitation of incidental or consequential damages so this limitation or exclusion may not apply to you. This warranty gives you specific legal rights, and you may also have other rights which vary from state to state.

Outside the United States, a different warranty may apply. For details, please contact your authorized Whirlpool distributor or military exchange.

LIMITED DOMESTIC FOOD LOSS COVERAGE REIMBURSEMENT FOR FOOD LOSSES

During the first year of ownership, the Whirlpool Freezer warranty provides reimbursement as outlined below for food actually spoiled while stored in the freezer as a result of defects in materials or workmanship. During the second through tenth years of ownership, reimbursement will be made as outlined below for food actually spoiled while stored in the freezer as a result of a **FAILURE OF THE SEALED REFRIGERATION SYSTEM.**

Food spoilage losses must be verified by Whirlpool or an authorized WhirlpoolSM service company. Reimbursement of loss will be based on domestic use and freezer size up to the total cumulative amount shown for the ten year warranty period.

9.9 cu. ft. or smaller	up to \$ 75.00 maximum payment
10.0 cu. ft. to 16.0 cu. ft.	up to \$125.00 maximum payment
16.1 cu. ft. and larger	up to \$200.00 maximum payment

The reimbursement amounts shown are representative for the contents of typical freezers by size and may or may not cover the actual replacement costs of the contents of your freezer. They are the maximum amounts, however, that will be paid and they are cumulative for the ten year warranty period.

Sorry, but Whirlpool is not responsible for food losses caused by natural spoilage, misuse or negligent care of the freezer, or by accidental or intentional disconnecting of the electric power cord, power interruption, inadequate power, fire damage, water damage, theft, or riots, strikes, war or acts of God.

If you need service, first see the "Service and Assistance" section of your freezer Use and Care Guide. After checking "Service and Assistance," additional help can be found by calling our COOL-LINE® service assistance telephone number, **1-800-253-1301**, from anywhere in the U.S.