



# TOSHIBA

# OWNER'S MANUAL

---

## Color Television

# 19A25C

© 2005 TOSHIBA CORPORATION  
All Rights Reserved

### Owner's Record

The model number and serial number are on the back of your TV. Record these numbers in the spaces below. Refer to these numbers whenever you communicate with your Toshiba dealer about this TV.

Model number:  Serial number:



## Dear Customer,

Thank you for purchasing this Toshiba TV. This manual will help you use the many exciting features of your new TV.

**Before operating the TV, please read this manual completely, and keep it nearby for future reference.**

## Safety Precautions

### WARNING

**TO REDUCE THE RISK OF FIRE OR ELECTRIC SHOCK, DO NOT EXPOSE THIS APPLIANCE TO RAIN OR MOISTURE.**

	<b>WARNING</b> RISK OF ELECTRIC SHOCK DO NOT OPEN	
<b>WARNING: TO REDUCE THE RISK OF ELECTRIC SHOCK, DO NOT REMOVE COVER (OR BACK). NO USER-SERVICEABLE PARTS INSIDE. REFER SERVICING TO QUALIFIED SERVICE PERSONNEL.</b>		



The lightning symbol in the triangle tells you that the voltage inside this product may be strong enough to cause an electric shock. **DO NOT TRY TO SERVICE THIS PRODUCT YOURSELF.**



The exclamation mark in the triangle tells you that important operating and maintenance instructions follow this symbol.

**CAUTION: To reduce the risk of electric shock, do not use the polarized plug with an extension cord, receptacle, or other outlet unless the blades can be inserted completely to prevent blade exposure.**

## NOTE TO CATV INSTALLERS

This is a reminder to call the CATV system installer's attention to Article 820-40 of the NEC, which provides guidelines for proper grounding and, in particular, specifies that the cable ground shall be connected to the grounding system of the building, as close to the point of cable entry as practical. For additional antenna grounding information, see items 25 and 26 on page 4.

## NOTICE OF POSSIBLE ADVERSE EFFECTS ON TV PICTURE DISPLAY

If a fixed (non-moving) pattern or image remains on the TV screen for extended periods of time, the image can become permanently ingrained in the cathode ray tube(s) of the TV and cause subtle but permanent ghost images. **This type of damage is NOT COVERED BY YOUR WARRANTY.** (See item 33 on page 4 for details.)

2

0303

# Child Safety

## It Makes A Difference Where Your TV Stands



**Congratulations on your purchase! As you enjoy your new TV, keep these safety tips in mind:**

## The Issue

- If you are like most consumers, you have a TV in your home. Many homes, in fact, have more than one TV.
- The home theater entertainment experience is a growing trend, and larger TVs are popular purchases; however, they are not always supported on the proper TV stands.
- Sometimes TVs are improperly secured or inappropriately situated on dressers, bookcases, shelves, desks, audio speakers, chests, or carts. As a result, TVs may fall over, causing unnecessary injury.



## Toshiba Cares!

- The consumer electronics industry is committed to making home entertainment enjoyable and safe.
- The Consumer Electronics Association formed the Home Entertainment Support Safety Committee, comprised of TV and consumer electronics furniture manufacturers, to advocate children's safety and educate consumers and their families about television safety.

## Tune Into Safety

- One size does NOT fit all! Use appropriate furniture large enough to support the weight of your TV (and other electronic components).
- Use appropriate angle braces, straps, and anchors to secure your furniture to the wall (but never screw anything directly into the TV).
- Carefully read and understand the other enclosed instructions for proper use of this product.
- Do not allow children to climb on or play with furniture and TVs.
- Avoid placing any item on top of your TV (such as a VCR, remote control, or toy) that a curious child may reach for.
- Remember that children can become excited while watching a program and can potentially push or pull a TV over.
- Share our safety message about this hidden hazard of the home with your family and friends. Thank you!



**CEA**  
Consumer Electronics Association

2500 Wilson Blvd.  
Arlington, VA 22201 U.S.A.  
Tel. 703-907-7600 Fax 703-907-7690  
www.CE.org

*CEA is the Sponsor, Producer and Manager of the International CES®*



## Important Safety Instructions

- 1) **Read these instructions.**
- 2) **Keep these instructions.**
- 3) **Heed all warnings.**
- 4) **Follow all instructions.**



- 5) **Do not use this apparatus near water.**



- 6) **Clean only with a dry cloth.**

- 7) **Do not block any ventilation openings.** Install in accordance with the manufacturer's instructions.



- 8) **Do not install near any heat sources** such as radiators, heat registers, stoves, or other apparatus (including amplifiers) that produce heat.



- 9) **Do not defeat the safety purpose of the polarized or grounding type plug.** A polarized plug has two blades with one wider than the other. A grounding type plug has two blades and a third grounding prong. The wide blade or the third prong are provided for your safety. If the provided plug does not fit into your outlet, consult an electrician for replacement of the obsolete outlet.

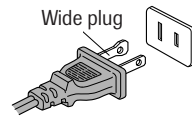

- 10) **Protect the power cord** from being walked on or pinched, particularly at plugs, convenience receptacles, and the point where it exits the apparatus.

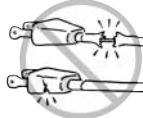

- 11) **Only use attachments/accessories specified by the manufacturer.**

- 12) **Use only with the cart, stand, tripod, bracket, or table specified by the manufacturer, or sold with the apparatus.** When a cart is used, use caution when moving the cart/apparatus combination to avoid injury from tip-over.



- 13) **Unplug this apparatus during lightning storms or when unused for long periods of time.**



- 14) **Refer all servicing to qualified service personnel.** Servicing is required when the apparatus has been damaged in any way, such as power supply cord or plug is damaged, liquid has been spilled or objects have fallen into the apparatus, the apparatus has been exposed to rain or moisture, does not operate normally, or has been dropped.



- 15) **CAUTION:** To reduce the risk of electric shock, do not use the polarized plug with an extension cord, receptacle, or other outlet unless the blades can be inserted completely to prevent blade exposure.



## Installation, Care, and Service

### Installation

Follow these recommendations and precautions and heed all warnings when installing your TV:

- 16) Never modify this equipment. Changes or modifications may void: a) the warranty, and b) the user's authority to operate this equipment under the rules of the Federal Communications Commission.

- 17) **DANGER: RISK OF SERIOUS PERSONAL INJURY, DEATH, OR EQUIPMENT DAMAGE!** Never place the TV on an unstable cart, stand, or table. The TV may fall, causing serious personal injury, death, or serious damage to the TV.



- 18) Never place or store the TV in direct sunlight; hot, humid areas; areas subject to excessive dust or vibration; or locations with temperatures at or below 41°F (5°C).



- 19) Always place the TV on the floor or a sturdy, level, stable surface that can support the weight of the unit.



- 20) Never place items such as vases, aquariums, or candles on top of the TV.



- 21) Never block or cover the slots or openings in the TV cabinet back, bottom, and sides. Never place the TV:
  - on a bed, sofa, rug, or similar surface;
  - too close to drapes, curtains, or walls; or
  - in a confined space such as a bookcase, built-in cabinet, or any other place with poor ventilation.



- 21) Never block or cover the slots or openings in the TV cabinet back, bottom, and sides. Never place the TV:
    - on a bed, sofa, rug, or similar surface;
    - too close to drapes, curtains, or walls; or
    - in a confined space such as a bookcase, built-in cabinet, or any other place with poor ventilation.
- The slots and openings are provided to protect the TV from overheating and to help maintain reliable operation of the TV.



- 22) Never allow anything to rest on or roll over the power cord, and never place the TV where the power cord is subject to wear or abuse.

- 23) Never overload wall outlets and extension cords.



0303



24) Always operate this equipment from a 120V AC, 60 Hz power source only.

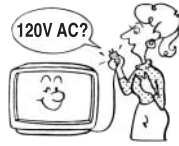

25) Always make sure the antenna system is properly grounded to provide adequate protection against voltage surges and built-up static charges (see Section 810 of the National Electric Code).

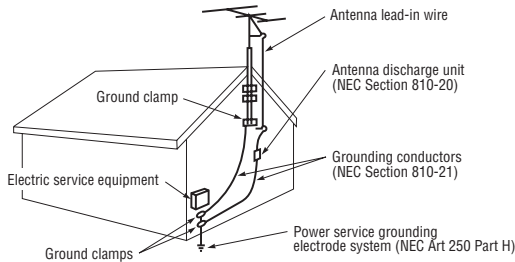

- 26) **! DANGER: RISK OF SERIOUS PERSONAL INJURY OR DEATH!**
- Use extreme care to make sure you are never in a position where your body (or any item you are in contact with, such as a ladder or screwdriver) can accidentally touch overhead power lines. Never locate the antenna near overhead power lines or other electrical circuits.
  - Never attempt to install any of the following during lightning activity:
    - a) an antenna system; or b) cables, wires, or any home theater component connected to an antenna or phone system.

## Care

For better performance and safer operation of your TOSHIBA TV, follow these recommendations and precautions:

27) Always sit approximately 10–25 feet away from the TV and as directly in front of it as possible. The picture can appear dull if you sit too far to the left or right of the TV, or if sunlight or room lights reflect on the screen. Turn the TV off to check for reflections on the screen, and then remove the source of reflections while viewing the TV.

28) Always unplug the TV before cleaning. Never use liquid or aerosol cleaners.

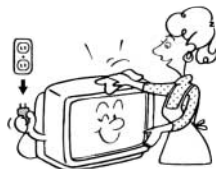

29) **! WARNING: RISK OF ELECTRIC SHOCK!** Never spill liquids or push objects of any kind into the TV cabinet slots.

30) [This item applies to projection TVs only.] If the air temperature rises suddenly (for example, when the TV is first delivered), condensation may form on the lenses. This can make the picture appear distorted or the color appear faded. If this happens, turn off the TV for 6 to 7 hours to allow the condensation to evaporate.

31) For added protection of your TV from lightning and power surges, always unplug the power cord and disconnect the antenna from the TV if you leave the TV unattended or unused for long periods of time.

32) During normal use, the TV may make occasional snapping or popping sounds. This is normal, especially when the unit is being turned on or off. If these sounds become frequent or continuous, unplug the power cord and contact a Toshiba Authorized Service Center.

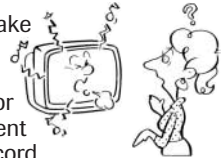

33) **Possible Adverse Effects on TV Picture Display:** If a fixed (non-moving) pattern or image remains on the TV screen for extended periods of time, the image can become permanently ingrained in the cathode ray tube(s) of the TV and cause subtle but permanent ghost images. **This type of damage is NOT COVERED BY YOUR WARRANTY.**

Never leave the TV on for extended periods of time while it is displaying the following images or formats:

- **Fixed Images**, including but not limited to PIP/POP windows, closed captions, video game patterns, TV station logos, stock tickers, and websites.
- **Special Formats** that do not use the entire screen, including but not limited to widescreen or letterbox format media viewed on a 4:3 aspect ratio display (with gray or black bars at the top and bottom of the screen); or 4:3 aspect ratio format media viewed on a widescreen/16:9 aspect ratio display (with gray or black bars on the left and right sides of the screen).

## Service

34) **! WARNING: RISK OF ELECTRIC SHOCK!** Never attempt to service the TV yourself. Opening and removing the covers may expose you to dangerous voltage or other hazards. Refer all servicing to a Toshiba Authorized Service Center.



35) If you have the TV serviced:

- Ask the service technician to use only replacement parts specified by the manufacturer.
- Upon completion of service, ask the service technician to perform routine safety checks to determine that the TV is in safe operating condition.



36) When the TV reaches the end of its useful life, ask a qualified service technician to properly dispose of the TV. Improper disposal may result in a picture tube implosion and possible personal injury.



## FEATURES

- **181 Channel Tuner** - The tuning system is capable of receiving all 68 VHF/UHF standard broadcast channels that are available in your area. When operating on a cable system, it can tune to the standard VHF channel frequencies plus up to 113 cable channel frequencies. The actual number of channels received depends upon channel reception in your area or your cable system.
- **On-screen 3 Language Display** - This TV can display the on-screen language in English, Spanish, or French.
- **Sleep Timer** - Operable from the remote control, the TV can be programmed to turn off automatically (from 10 to 120 minutes, in 10-minute increments).
- **Memory Back Up** - This system prevents loss of memorized channel selections in case a power interruption to the TV should occur.
- **Picture Control Adjustments** - The on-screen display allows precise remote control adjustment of BRIGHTNESS, CONTRAST, COLOR, TINT, and SHARPNESS.
- **Closed Captioned Decoder** - Displays closed captions or text on-screen (when available).
- **Lock feature** - This feature has three functions, LOCKING CHANNELS, LOCKING VIDEO INPUT, and SETTING THE GameTimer™.
- **Programmable ON Timer** - Allows you to program the TV to automatically turn on at a set time.

## LOCATION OF CONTROLS

FRONT

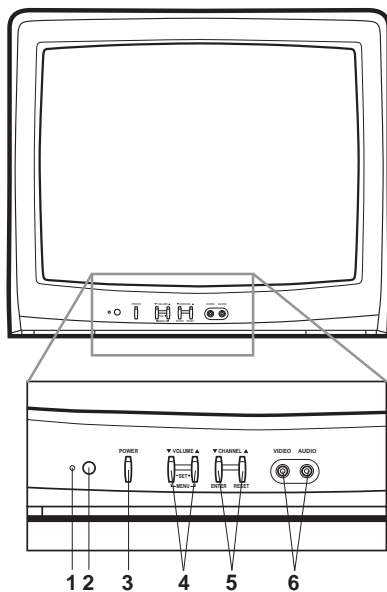

BACK

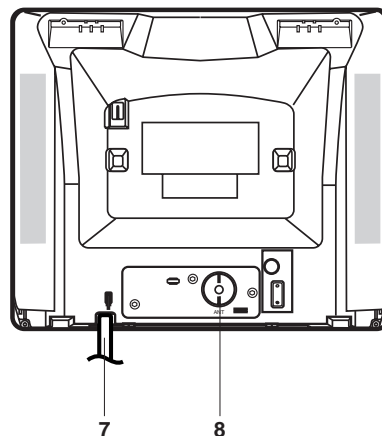

- 1. POWER indicator** - Lights up when the power is turned on.
- 2. Remote Sensor** - Signals from the Remote Control unit are received here.
- 3. POWER Button** - Press to turn the TV on or off.
- 4. VOLUME ▲/▼ Buttons** - Press to raise or lower the level of the sound.  
**(MENU Buttons)** - Press both VOLUME ▲/▼ buttons at the same time to display the on-screen menu functions.  
**(SET + / - Buttons)** - Press to select the desired setting during on-screen operations.
- 5. CHANNEL ▲/▼ Buttons** - Press to select a higher or lower numbered channel that was programmed into memory.
- (ENTER Button)** - Press to enter or select information for on-screen operations.
- (RESET Button)** - Press, while in the on-screen menu mode, to reset the on-screen picture adjustments to their factory preset positions.
- 6. AUDIO/VIDEO IN Jacks** - Audio and video signal cables from an external source can be connected here.
- 7. AC Power Cord** - Plug into an outlet with 120V, 60 Hz AC power only.
- 8. VHF/UHF IN (ANT) Jack** - Connect a VHF/UHF antenna or Cable TV 75 ohm coaxial cable to this jack.





## REMOTE CONTROL

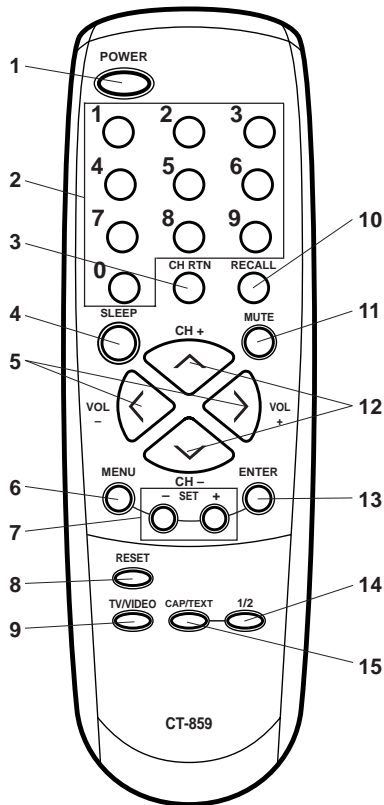

1. **POWER Button** - Press to turn on the TV. Press again to turn off the TV.
2. **Direct Channel Selection/Channel Number Buttons (0-9)** - Allow direct tuning of any channel.
3. **CH RTN Button** - Repeatedly press CH RTN to toggle back and forth between the last two channels you tuned.

Before using the remote control, batteries must first be installed.

### HOW TO INSTALL BATTERIES

1. Open the battery compartment cover.

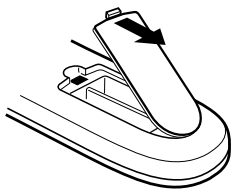

2. Install two "AAA" (penlight size) batteries.

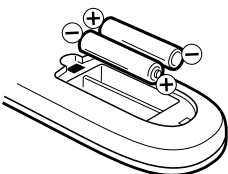

3. Replace the battery compartment cover.

6

4. **SLEEP Button** - To set the TV to turn off after a preset amount of time, press the SLEEP button on the remote control. The clock will count down 10 minutes each time the button is pressed in the order of 120, 110, 100, ..... 20, 10, 0. After the sleep time is programmed, the display will disappear then reappear momentarily every ten minutes to remind you the sleep timer function is operating. To confirm the sleep time setting, press the SLEEP button once and the remaining time will be momentarily displayed. To cancel the sleep timer, press the SLEEP button repeatedly until the display turns to 0.
5. **VOL (VOLUME) + / - Buttons** - Press the + button to increase or the - button to decrease the volume level.
6. **MENU Button** - Press to display the on-screen menu function.
7. **SET + / - Buttons** - Press to select the desired setting during on-screen operations.
8. **RESET Button** - Press to reset the on-screen picture adjustments to their factory preset positions.
9. **TV/VIDEO Button** - Switches between the TV and external device inputs.
10. **RECALL Button** - When you press this button, the channel number will appear in the upper right corner of the screen. Press the button again to remove it from the screen.
11. **MUTE Button** - To turn off the sound, press this button once. The TV will be silenced and the word "MUTE" will appear on the screen. The muting feature can be released by pressing the MUTE button again or one of the VOL + or - buttons.
12. **CH (CHANNEL) + / - Buttons** - Press the CH + button to change to a higher numbered channel set into memory. Press the CH - button to change to a lower numbered channel set into memory.
13. **ENTER Button** - Press to enter or select information for on-screen operations.
14. **1/2 Button** - Switches between captions channel 1 and captions channel 2 in the closed caption mode.
15. **CAP/TEXT Button** - Press to switch between normal TV and the two closed caption modes (captions or text), when available.

Use two "AAA" size penlight batteries (supplied) for the remote control. The batteries may last approximately one year depending on how much the remote control is used. For best performance, it is recommended that you replace the batteries on a yearly basis or when the remote operation becomes erratic.

#### Caution:

- Never throw batteries into a fire.

#### Notes :

- Be sure to use AAA size batteries.
- Dispose of batteries in a designated disposal area.
- Batteries should always be disposed of with the environment in mind. Always dispose of batteries in accordance with applicable laws and regulations.
- If the remote control does not operate correctly, or if the operating range becomes reduced, replace batteries with new ones.
- When necessary to replace batteries in the remote control, always replace both batteries with new ones. Never mix battery types or use new and used batteries in combination.
- Always remove batteries from remote control if they are dead or if the remote control is not to be used for an extended period of time. This will prevent battery acid from leaking into the battery compartment.

# ANTENNA/CABLE TV CONNECTIONS

Choose one of the following seven connections, based on your equipment and service:

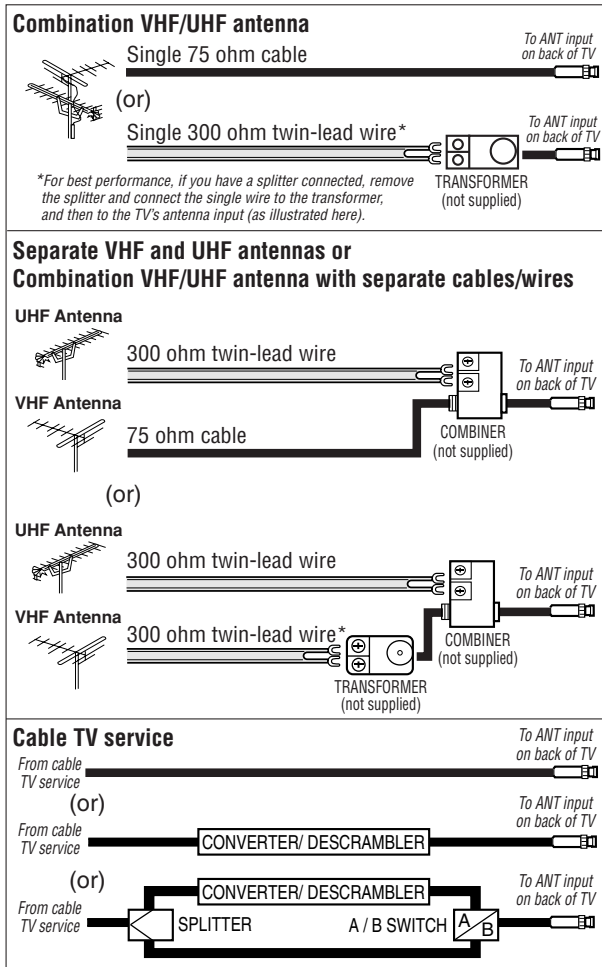

## Combination VHF/UHF antenna (Single 75 ohm cable or 300 ohm twin-lead wire)

Connect the 75 ohm cable from a combination VHF/UHF antenna to the antenna jack. If your combination antenna has a 300 ohm twin-lead wire, use the 300-75 ohm matching transformer (not supplied).

## Combination VHF/UHF antenna (Separate VHF and UHF 300 ohm twin-leads)

Connect the UHF twin-lead wire to a combiner (not supplied). Connect the VHF twin-lead to the 300-75 ohm matching transformer (not supplied). Attach the transformer to the combiner. Attach the combiner to the antenna jack.

## Separate VHF/UHF antennas

Connect the 75 ohm cable from the VHF antenna and the UHF antenna twin-lead to a combiner (not supplied). Attach the combiner to the antenna jack.

**NOTE:** If your VHF antenna has a twin-lead wire, use the 300-75 ohm matching transformer (not supplied), then connect the transformer to the combiner.

## For subscribers to basic cable TV service

For basic cable service not requiring a converter/descrambler box, connect the Cable TV 75 ohm coaxial cable directly to the antenna jack on the back of the television.

## For subscribers to scrambled cable TV service

If you subscribe to a cable service that requires the use of a converter/descrambler box, connect the incoming cable to the converter/descrambler box and connect the output of the box to the antenna jack on the back of the television. Follow the connections shown at left. Set the television to the output of the converter/descrambler box (usually channel 3 or 4) and use the converter/descrambler box to select channels.

## For subscribers to unscrambled basic cable with scrambled premium channels

If you subscribe to a cable service in which basic cable channels are unscrambled and premium channels require the use of a converter/descrambler box, you may wish to use a two-set signal splitter (sometimes called a "two-set coupler") and an A/B switch box from the cable installer or an electronics supply store. Follow the connections shown at left. With the switch in the "B" position, you can directly tune any nonscrambled channels on your TV. With the switch in the "A" position, tune your TV to the output of the converter/descrambler box (usually channel 3 or 4) and use the box to tune scrambled channels.

This television has an extended tuning range and can tune most cable channels without using a cable company supplied converter box. Some cable companies offer "premium pay channels" in which the signal is scrambled. Descrambling these signals for normal viewing requires the use of a descrambler device, which is generally provided by the cable company.

# CONNECTION TO OTHER EQUIPMENT

The exact arrangement you use to interconnect various video and audio components to the TV is dependent on the model and features of each component. Check the owner's manual provided with each component for the location of video and audio inputs and outputs. The following connection diagrams are offered as suggestions. You may need to modify them to accommodate your particular assortment of components.

## TV/VIDEO SELECTION

To view the picture from a VCR, camcorder, or VIDEO game, you must put the TV in VIDEO mode first. Press **TV/VIDEO** to select VIDEO mode. The word "VIDEO" displays briefly on-screen. Press **TV/VIDEO** again to return to TV mode.

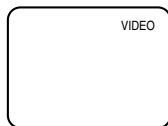

### 1. To connect the TV to a VCR

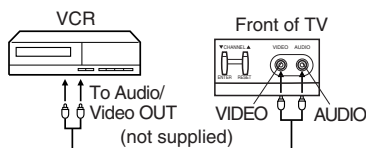

The unauthorized recording, use, distribution, or revision of television programs, videotapes, DVDs, and other materials is prohibited under Copyright Law, and may subject you to civil and criminal liability.

### 2. To connect the TV to a VIDEO Game

The TV also can be used as a display device for many video games. However, due to the wide variety of signals generated by these devices and subsequent hook-up variations required, they have not all been included in the suggested connection diagrams. You will need to consult each device's owner's manual for additional information.

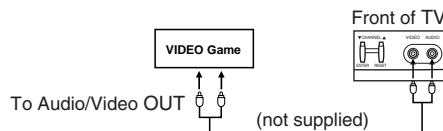

### 3. To connect the TV to a camcorder

To playback from the camcorder, connect the camcorder to the TV as shown.

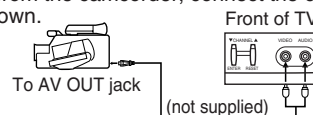



# SETTING THE LANGUAGE

This TV can display the on-screen displays and adjustment menus in English, Spanish, or French. The on-screen language selection (step 3, below) will automatically appear on the screen when you press the MENU button initially. Select the language you prefer first, then proceed with the other menu options.

1 Press **MENU**.

2 Press **SET +** or **-** to select the **LANGUAGE** mode, then press **ENTER**.

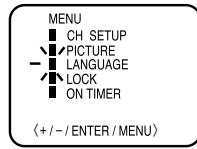

3 Press **SET +** or **-** until the "▶" indicator points to the desired language: English (ENGLISH), Spanish (ESPAÑOL) or French (FRANCAIS), then press **ENTER**.

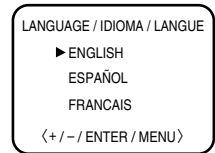

4 Press **MENU** repeatedly until the menu screen is cleared.

### NOTE:

If Spanish or French is chosen, the closed caption indicators will be in the selected language, but the closed caption text will not be affected by the language selection.

# TV OPERATION

1 To turn on the TV, press **POWER**.

2 The **VOLUME** can be adjusted to a desired level by pressing **VOL (VOLUME) +** or **-**.

The sound level will be indicated on the TV screen by **GREEN BARS AND A NUMBER**. As the sound level increases, so do the number of **BARS AND THE NUMBER** on the screen. The same is true for decreasing the level.

3 Set the **TV/CABLE** menu option to the appropriate position. When shipped from the factory, this menu option is in the **CABLE** setting. See "TO MEMORIZE CHANNELS" on page 9.



4 **CH (CHANNEL) +** and **-** buttons  
Press and release **CH (CHANNEL) +** or **-**. The channel automatically stops at the next channel programmed into the TV's memory. Press and hold the button down to change channels more quickly.

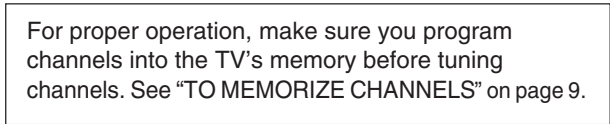

**DIRECT CHANNEL SELECTION buttons (0-9)** - Press these buttons to select a channel. The channel number will appear in the upper right corner of the TV screen. If an invalid channel number is selected, the display will revert to the previous channel.

**TV MODE DIRECT CHANNEL SELECTION** - When the TV/CABLE menu option is in the "TV" position, all channels can be instantly selected by using two buttons (For example, to select channel 2, press "0," then "2." If you press only "2," channel selection will be delayed for a few seconds). For channels 10 and above, press the two digits in order.

**CABLE mode direct channel selection**  
When the TV/CABLE menu option is in the CABLE position, channels can be selected as follows:

1-9	Press "0" twice, then 1-9 as needed. Example, to select channel 2, press "002."
10-12	Press "0", then the remaining 2 digits. Example, to select channel 12, press "012."
13-99	Press the 2 digits in order. Example, to select channel 36, press "36."
100-125	Press the 3 digits in order. Example, to select channel 120, press "120."

**NOTE:** If the station being viewed stops broadcasting, the TV will automatically shut off after 15 minutes.





## TO MEMORIZE CHANNELS

This TV is equipped with a channel memory feature that allows the TV to skip up or down to the next channel in the TV's memory, skipping over unwanted channels.

Before selecting channels, you must program them into the TV's memory. In addition to normal VHF and UHF channels, this TV can receive up to 113 Cable TV channels. To use this TV with an antenna, set the TV/CABLE menu option to the TV setting. When shipped from the factory, this menu option is in the CABLE setting.

### TV/CABLE SELECTION

- 1 Press **MENU**.
- 2 Press **SET +** or **-** until the indicator next to "CH SETUP" begins to flash, then press **ENTER**.
- 3 Press **SET +** or **-** until the indicator next to "TV/CABLE" begins to flash.
- 4 Press **ENTER** to select the TV or CABLE mode. The arrow indicates the selected mode.
- 5 Repeatedly press **MENU** until the menu screen closes.

#### NOTE:

Contact your cable company to determine the type of cable system used in your area.

### TO ADD/DELETE CHANNELS

- 1 Press **MENU**.
- 2 Press **SET +** or **-** until the indicator next to "CH SETUP" begins to flash, then press **ENTER**.
- 3 Press **SET +** or **-** until the indicator next to "ADD/DELETE" begins to flash, then press **ENTER**.
- 4 Select the desired channels to be added or deleted using the Direct Channel Selection buttons (0-9), **CH +** or **-**, **SET +** or **-**.
- 5 Press **ENTER** to select ADD or DELETE. If an unmemorized channel was selected (step 4), the channel indication will be red. Press **ENTER** if you wish to ADD the unmemorized channel. The channel indicator will change from red to green when a channel is added and the channel will be memorized.

If a memorized channel was selected (step 4), the channel indication will be green. To delete the channel from memory, press **ENTER** repeatedly until "DEL" appears on the screen. The

- 6 Repeatedly press **MENU** until the menu screen closes.

- 4 Repeatedly press **MENU** until the menu screen closes.



# CLOSED CAPTION

## WHAT IS CLOSED CAPTIONING?

This television has the capability to decode and display closed captioned television programs. When available, closed captioning will display captions on a small portion of the screen for hearing impaired viewers or it will translate and display text in another language on half of the screen.

## TO VIEW CLOSED CAPTIONS

Press **CAP/TEXT** on the remote control to switch between normal TV and the two closed caption modes (Captions and half-screen Text).

**Captions:** This closed caption mode will display captions on the screen in English or another language (depending on the setting of **Closed Captions 1/2**). Generally, closed captions in English are transmitted on captions channel 1 and closed captions in other languages are transmitted on captions channel 2.

The captions will appear in places on the screen where they will least interfere with the picture, usually on the bottom of the screen. News programs will usually show three-line closed captions that scroll onto the screen. Most other shows provide two- or three-line captions placed near the character who is speaking so the viewer can follow the dialogue. Words in italics or underlined describe titles, words in foreign languages, or words requiring emphasis. Words that are sung usually appear enclosed by musical notes.

**Text:** When available, the Text mode will fill half of the screen with a programming schedule or other information.

After selecting a closed caption mode, it will stay in effect until you select another mode, even if the channel is changed. If the captions signal is lost due to a commercial or a break in the signal, the captions will reappear when the signal is received again. When you change channels, the display of captions will be delayed approximately 10 seconds.

For television programs broadcasting with closed captions, look in TV program listings for the closed captions symbol ("CC").

### NOTICE OF POSSIBLE ADVERSE EFFECTS ON TV PICTURE DISPLAY

Avoid displaying stationary images on your TV screen for extended periods of time. Fixed (non-moving) patterns or images (including but not limited to PIP/POP windows, closed captions, video game patterns, TV station logos, stock tickers, websites, and special formats that do not use the entire screen) can become permanently ingrained in the cathode ray tube(s) of the TV and cause subtle but permanent ghost images. **This type of damage is NOT COVERED BY YOUR WARRANTY.**

- When activating the closed captioned decoder, there will be a short delay before the closed captioned text appears on the screen.
- Closed captioned text is only displayed in areas in which it is available.
- If no caption signal is received, no captions will appear, but the television will remain in the caption mode.
- Misspellings or unusual characters may occasionally appear during closed captioning. This is normal with closed captioning, especially with live programs. This is because during live programs, captions are also entered live. These transmissions do not allow time for editing.
- When captions are being displayed, on-screen displays such as volume and mute may not be seen or may interfere with closed captions.
- Some cable systems and copy protection systems may interfere with the closed captioned signal.
- If using an indoor antenna or if TV reception is very poor, the closed caption decoder may not appear or may appear with strange characters or misspelled words. In this case, adjust the antenna for better reception or use an outdoor antenna.

# TO SET THE ON TIMER

This feature allows you to program the TV to turn on automatically at a set time and channel.

**NOTE:** After a power failure or disconnection of the power, the timer setting will be lost.

- 1 Press **MENU**, then press **SET +** or **-** until the indicator next to "ON TIMER" begins to flash. Then press **ENTER**. The ON TIMER menu appears.

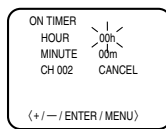

- 4 Press **SET +** or **-** to set the desired channel, then press **ENTER**.

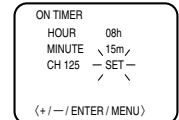

- 2 Press **SET +** or **-** to set the desired hour (0-12), then press **ENTER**.
- 3 Press **SET +** or **-** to set the desired minutes (00, 05, 10, ...55), then press **ENTER**.

- 5 Press **SET +** or **-** to select the SET mode, then press **ENTER**.
- 6 Repeatedly press **MENU** until the menu screen closes.

### NOTE:

To cancel the ON TIMER, select CANCEL in step 5 above. Repeatedly press MENU until the menu screen closes.



# USING THE LOCK MENU

The LOCK menu includes the CH LOCK, VIDEO LOCK, GAME TIMER and CHANGE PASSWORD functions. You can use these functions after entering the correct PASSWORD.

## TO REGISTER YOUR PASSWORD

- 1 Press **MENU** and then press **SET** + or – until the indicator next to “LOCK” begins to flash, then press **ENTER**.
- 2 Enter your 4-digit password using the Channel Number buttons (0–9). If you enter an incorrect password, press **RESET**, and then press **ENTER**.
- 3 Enter the password again, and then press **ENTER**. The password is now registered and the LOCK menu appears.

### NOTES:

- To change your password, follow steps 1 and 2 and select “CHANGE PASSWORD” option. Then enter your new password.
- If you forget or lose your password, you can reset it using the following procedure:
  - While holding down the VOLUME ▼ button on the TV, press “0” on the remote control for a few seconds.

## LOCKING CHANNELS

With the CH LOCK feature, you can lock specific channels. You will not be able to tune locked channels unless you clear the setting. You can choose to lock up to nine TV channels and nine cable channels.

- 1 Use the Channel Number buttons (0–9) to tune the television to the channel you wish to lock.
- 2 Press **MENU**, then press **SET** + or – until the indicator next to “LOCK” begins to flash. Then press **ENTER**.
- 3 Use the Channel Number buttons (0–9) to enter your password, then press **ENTER**. The LOCK menu appears.
- 4 Press **SET** + or – until the indicator next to “CH LOCK” begins to flash, then press **ENTER**.
- 5 Press **SET** + or – to select:
  - INPUT: To select the channel as one to be locked. Then press **ENTER**.
  - ALL CLEAR: To clear all channels from the list of locked channels. Then press **ENTER**.

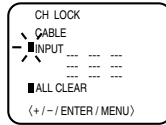
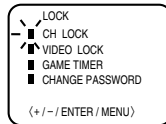

- 6 Repeat steps 1 through 5 to lock other channels. When you are finished locking channels, repeatedly press **MENU** until the menu screen closes.

If you try to tune a locked channel, the TV will not display it, but will display the nearest unlocked channel.

### NOTES:

- If you are accessing the LOCK menus for the first time, choose a four-digit number to be your password.
- After programming CH LOCK, change channels before turning off the television.
- To unlock all channels, select ALL CLEAR in step 5, then press **ENTER**.

## LOCKING VIDEO INPUT

You can use the VIDEO LOCK feature to lock the input source (VIDEO) and channels 3 and 4. You will not be able to select the input sources with the TV/VIDEO button or Channel Number buttons unless you clear the setting.

- 1 Press **MENU**, then press **SET** + or – until the indicator next to “LOCK” begins to flash, then press **ENTER**.
- 2 Use the Channel Number buttons (0–9) to enter your password, then press **ENTER**. The LOCK menu appears.
- 3 Press **SET** + or – until the indicator next to “VIDEO LOCK” begins to flash, then press **ENTER**.
- 4 Press **SET** + or – to select:
  - OFF: Unlocks all video input sources.
  - VIDEO: Locks VIDEO.
  - VIDEO +: Locks VIDEO, channel 3, and channel 4. This option should be used if you use the antenna to play a video tape.
- 5 Repeatedly press **MENU** until the menu screen closes.

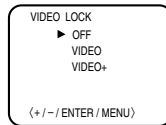

### NOTE:

After programming VIDEO LOCK, change channels or press the TV/VIDEO key before turning off the television.

## SETTING THE GameTimer™

You can use the GameTimer™ feature to automatically activate the VIDEO LOCK feature (VIDEO setting) to set a time limit for playing a video game (30, 60, 90, or 120 minutes).

- 1 Press **MENU**, then press **SET** + or – until the indicator next to “LOCK” begins to flash, then press **ENTER**.
- 2 Use the Channel Number buttons (0–9) to enter your password, then press **ENTER**. The LOCK menu appears.
- 3 Press **SET** + or – until the indicator next to “GAME TIMER” begins to flash, then press **ENTER**.
- 4 Press **SET** + or – to select a time limit (30 minutes, 60 minutes, 90 minutes, 120 minutes, or OFF).
- 5 Repeatedly press **MENU** until the menu screen closes. After the GameTimer is programmed, a display will appear briefly every ten minutes to remind you that the GameTimer is operating. When the programmed end time is reached, the TV will change the channels automatically and the VIDEO LOCK feature will be activated.

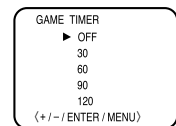

### To turn off the VIDEO LOCK:

See “LOCKING VIDEO INPUT,” at left.



# TROUBLESHOOTING GUIDE

Before requesting service, please refer to the following chart for the symptom and possible solution.

SYMPTOMS	POSSIBLE SOLUTIONS
TV does not operate.	<ul style="list-style-type: none"> <li>• Make sure the power cord is plugged in.</li> <li>• Try another AC outlet.</li> <li>• Power is off; check fuse or circuit breaker.</li> <li>• Unplug unit for an hour, then plug it back in.</li> </ul>
Poor sound or no sound.	<ul style="list-style-type: none"> <li>• Station or Cable TV experiencing problems; tune to another station or call your Cable company.</li> <li>• Check sound adjustments (VOLUME and MUTE).</li> <li>• Check for sources of possible interference.</li> </ul>
Poor picture or no picture.	<ul style="list-style-type: none"> <li>• Station or Cable TV experiencing problems; tune to another station or call your Cable company.</li> <li>• Make sure channels are set into memory.</li> <li>• Check antenna or Cable TV connections. Adjust the antenna.</li> <li>• Check for sources of possible interference.</li> <li>• Check picture control adjustments.</li> <li>• Press CAP/TEXT to turn off the closed caption mode.</li> </ul>
Poor reception on some channels.	<ul style="list-style-type: none"> <li>• Station or Cable TV experiencing problems; tune to another station or call your Cable company.</li> <li>• Make sure channels are set into memory.</li> <li>• Station is weak; adjust antenna to receive desired station.</li> <li>• Check for sources of possible interference.</li> </ul>
Poor color or no color.	<ul style="list-style-type: none"> <li>• Station or Cable TV experiencing problems; tune to another station or call your Cable company.</li> <li>• Make sure channels are set into memory.</li> <li>• Check picture control adjustments.</li> <li>• Check antenna or Cable TV connections. Adjust the antenna.</li> </ul>
Picture wobbles or drifts.	<ul style="list-style-type: none"> <li>• Station or Cable TV experiencing problems; tune to another station or call your Cable company.</li> <li>• Make sure channels are set into memory.</li> <li>• Cable TV company is scrambling signal.</li> <li>• Adjust the antenna.</li> </ul>

SYMPTOMS	POSSIBLE SOLUTIONS
No Cable TV reception.	<ul style="list-style-type: none"> <li>• Check all Cable TV connections.</li> <li>• Set TV/CABLE menu option to the CABLE mode.</li> <li>• Station or Cable TV system problems; try another station or call your Cable company.</li> </ul>
Horizontal or diagonal bars on screen.	<ul style="list-style-type: none"> <li>• Check antenna connections; reorient antenna.</li> <li>• Check for sources of possible interference.</li> </ul>
No reception above channel 13.	<ul style="list-style-type: none"> <li>• Make sure TV/CABLE menu option is in the appropriate mode.</li> <li>• If using antenna, check UHF antenna connections.</li> </ul>
No Remote operation.	<ul style="list-style-type: none"> <li>• Batteries are weak, dead, or inserted incorrectly.</li> <li>• Remote control is out of range; move closer to the TV (within 15 feet).</li> <li>• Make sure remote control is aimed at sensor on TV.</li> <li>• Confirm there are no obstructions between the remote control and the TV.</li> <li>• Make sure the power cord is plugged in.</li> </ul>
TV shuts off.	<ul style="list-style-type: none"> <li>• Tuned station is not broadcasting.</li> <li>• Sleep Timer is set.</li> <li>• Power interrupted.</li> </ul>
Closed captions are not activated.	<ul style="list-style-type: none"> <li>• TV station experiencing problems or tuned program is not closed captioned. Try another channel.</li> <li>• Check Cable TV connection or VHF/UHF antenna. Reposition or rotate antenna.</li> <li>• Press CAP/TEXT to turn on the closed caption decoder.</li> </ul>
Black box on screen.	<ul style="list-style-type: none"> <li>• Press CAP/TEXT to turn off the closed caption mode.</li> </ul>
Display is not shown in your language.	<ul style="list-style-type: none"> <li>• Select the language in the menu options.</li> </ul>

## SPECIFICATIONS

- This model complies with the specifications below.
- Design and specifications are subject to change without notice.
- This model may not be compatible with features and/or specifications that may be added in the future.

AC Power Input:	120V, 60Hz
AC Power Consumption:	73 Watts
Picture Tube:	19 Inch (480mm diagonal) (Screen size is approximate.)
Audio Power Output Rating:	1.5 Watts
Speaker:	3 inches (76mm) Full Range, 8 ohm
Tuner Type:	181 Channel, Quartz PLL Frequency Synthesized
Remote Control:	Infrared, Direct Access, two AAA batteries (supplied)
Receiving Channels:	VHF 2-13 UHF 14-69 Cable TV 01-97 (5A)-(A-3); 98-99 (A-2)-(A-1); 14-22 (A)-(I); 23-36 (J)-(W); 37-65 (AA)-(FFF); 66-125 (GGG)-(125)
Antenna Input Impedance:	75 Ohm (VHF/UHF) Coaxial Input
Input:	Video: 1.0 Vp-p 75 ohm Audio: 300 mV, 47k ohm
Dimensions:	Width: 19-3/16 inches (488mm) Height: 16-3/8 inches (416mm) Depth: 18-5/16 inches (465mm)
Weight:	38.6 lbs (17.5 kg)

## ACCESSORY

Remote Control with two size "AAA" batteries



## Limited Canada Warranty for 27" and All Smaller Television Models

Toshiba of Canada Limited ("TCL") makes the following limited warranties to original consumers in Canada. THESE LIMITED WARRANTIES EXTEND TO THE ORIGINAL CONSUMER PURCHASER OR ANY PERSON RECEIVING THIS TELEVISION AS A GIFT FROM THE ORIGINAL CONSUMER PURCHASER AND TO NO OTHER PURCHASER OR TRANSFEREE.

PRODUCTS PURCHASED IN CANADA AND USED ANYWHERE OUTSIDE OF CANADA, INCLUDING, WITHOUT LIMITATION, THE U.S.A. AND MEXICO, ARE NOT COVERED BY THESE WARRANTIES.

PRODUCTS PURCHASED ANYWHERE OUTSIDE OF CANADA, INCLUDING, WITHOUT LIMITATION, THE U.S.A. AND MEXICO, AND USED IN CANADA, ARE NOT COVERED BY THESE WARRANTIES.

### Limited One (1) Year Warranty on Parts and Labor\*

TCL warrants this television and its parts against defects in materials or workmanship for a period of one (1) year after the date of original retail purchase. DURING THIS PERIOD, TCL WILL, AT TCL'S OPTION, REPAIR OR REPLACE A DEFECTIVE PART WITH A NEW OR REFURBISHED PART WITHOUT CHARGE TO YOU FOR PARTS OR LABOR. YOU MUST DELIVER THE ENTIRE TELEVISION TO AN AUTHORIZED TCL SERVICE DEPOT. YOU MUST PAY FOR ALL TRANSPORTATION AND INSURANCE CHARGES FOR THE TELEVISION TO AND FROM THE SERVICE DEPOT.

### Limited Two (2) Year Warranty on Picture Tube\*

TCL further warrants the picture tube in this television against defects in materials or workmanship for a period of two (2) years after the date of original retail purchase. DURING THIS PERIOD, TCL WILL, AT TCL'S OPTION, REPAIR OR REPLACE A DEFECTIVE PICTURE TUBE WITH A NEW OR REFURBISHED PICTURE TUBE WITHOUT CHARGE TO YOU, EXCEPT THAT, IF A DEFECTIVE PICTURE TUBE IS REPAIRED OR REPLACED AFTER ONE (1) YEAR FROM THE DATE OF THE ORIGINAL RETAIL PURCHASE, YOU MUST PAY ALL LABOR CHARGES INVOLVED IN THE REPAIR OR REPLACEMENT. YOU MUST DELIVER THE ENTIRE TELEVISION TO AN AUTHORIZED TCL SERVICE DEPOT. YOU MUST PAY FOR ALL TRANSPORTATION AND INSURANCE CHARGES FOR THE TELEVISION TO AND FROM THE SERVICE DEPOT.

### Rental Units

The warranty for rental units begins with the first rental or thirty (30) days from the date of shipment to the rental firm, whichever comes first.

### \*Limited Warranty for Commercial Units

TCL warrants televisions sold and used for commercial purposes as follows: all parts are warranted against defects in materials or workmanship for a period of ninety (90) days after the date of original purchase. DURING THIS PERIOD, TCL WILL, AT TCL'S OPTION, REPAIR OR REPLACE A DEFECTIVE PART WITH A NEW OR REFURBISHED PART WITHOUT CHARGE TO YOU FOR PARTS OR LABOR. YOU MUST DELIVER THE ENTIRE TELEVISION TO AN AUTHORIZED TCL SERVICE DEPOT. YOU MUST PAY FOR ALL TRANSPORTATION AND INSURANCE CHARGES FOR THE TELEVISION TO AND FROM THE SERVICE DEPOT.

### Owner's Manual and Product Registration

Read this owner's manual thoroughly before operating this television. Register your product online at [www.toshiba.ca](http://www.toshiba.ca) as soon as possible. By registering your product, you will enable TCL to bring you new products specifically designed to meet your needs and help us to contact you in the unlikely event a safety notification is required. Failure to register your product does not diminish your warranty rights.

### Your Responsibility

THE ABOVE WARRANTIES ARE SUBJECT TO THE FOLLOWING CONDITIONS:

- (1) You must provide your bill of sale or other proof of purchase.
- (2) All warranty servicing of this television must be performed by an Authorized TCL Service Depot.
- (3) These warranties from TCL are effective only if the television is purchased in Canada from an authorized TCL dealer and operated in Canada.
- (4) Labor charges for installation, setup, adjustment of customer controls, and installation or repair of antenna systems are not covered by these warranties. Reception problems caused by inadequate antenna systems are your responsibility.
- (5) Warranties extend only to defects in materials or workmanship as limited above and do not extend to any television or parts that have been lost or discarded by you or to damage to any television or parts caused by fires, misuse, accident, Acts of God (such as lightning or fluctuations in electric power), improper installation, improper maintenance, or use in violation of instructions furnished by TCL; or to units that have been modified or had the serial number removed, altered, defaced, or rendered illegible.

### How to Obtain Warranty Services

If, after following all of the operating instructions in this manual and checking the "Troubleshooting" section, you find that service is needed:

- (1) To find the nearest TCL Authorized Service Depot, visit TCL's web site at [www.toshiba.ca](http://www.toshiba.ca).
- (2) Present your bill of sale or other proof of purchase to the Authorized Service Depot. You must deliver the entire television to an Authorized TCL Service Depot. You must pay for all transportation and insurance charges for the television to and from the Service Depot.

**For additional information,  
visit TCL's web site: [www.toshiba.ca](http://www.toshiba.ca)**

ALL WARRANTIES IMPLIED BY THE LAW OF ANY PROVINCE OF CANADA, INCLUDING THE IMPLIED WARRANTIES OF MERCHANTABILITY AND FITNESS FOR A PARTICULAR PURPOSE, ARE EXPRESSLY LIMITED TO THE DURATION OF THE LIMITED WARRANTIES SET FORTH ABOVE. WITH THE EXCEPTION OF ANY WARRANTIES IMPLIED BY THE LAW OF ANY PROVINCE OF CANADA AS HEREBY LIMITED, THE FOREGOING WARRANTY IS EXCLUSIVE AND IN LIEU OF ALL OTHER WARRANTIES, GUARANTEES, AGREEMENTS, AND SIMILAR OBLIGATIONS OF TCL WITH RESPECT TO THE REPAIR OR REPLACEMENT OF ANY PARTS. IN NO EVENT SHALL TCL BE LIABLE FOR CONSEQUENTIAL OR INCIDENTAL DAMAGES (INCLUDING, BUT NOT LIMITED TO, LOST PROFITS, BUSINESS INTERRUPTION, OR MODIFICATION OR ERASURE OF RECORDED DATA CAUSED BY USE, MISUSE, OR INABILITY TO USE THIS PRODUCT).

No person, agent, distributor, dealer, or company is authorized to change, modify, or extend the terms of these warranties in any manner whatsoever. The time within which action must be commenced to enforce any obligation of TCL arising under this warranty or under any law of Canada or of any province thereof is hereby limited to 90 days from the date you discover, or should have discovered, the defect. This limitation does not apply to implied warranties arising under the law of any province of Canada.

THIS WARRANTY GIVES YOU SPECIFIC LEGAL RIGHTS, AND YOU MAY ALSO HAVE OTHER RIGHTS, WHICH MAY VARY FROM PROVINCE TO PROVINCE IN CANADA. SOME PROVINCES OF CANADA DO NOT ALLOW LIMITATIONS ON HOW LONG AN IMPLIED WARRANTY LASTS, WHEN AN ACTION MAY BE BROUGHT, OR THE EXCLUSION OR LIMITATION OF INCIDENTAL OR CONSEQUENTIAL DAMAGES, SO THE ABOVE LIMITATIONS OR EXCLUSIONS MAY NOT APPLY TO YOU UNDER SUCH CIRCUMSTANCES.



**CANADA LIMITED**

Street  
ario L3R 8H2

GameTimer is a trademark of Toshiba America Consumer Products, L.L.C.  
PRINTED IN THAILAND

**TOSHIBA**