

## FRIDGE FREEZER - MODELS FFA97 & FFM97 INSTRUCTIONS FOR INSTALLATION & USE

**GETTING STARTED:** To ensure that your fridge freezer runs reliably and efficiently follow these steps.

### STEP 1

Choose a location for your fridge freezer, away from any heat sources and allow adequate ventilation - 100mm (4 inch) gap above.



### STEP 2

Move the fridge freezer into position, using the sides of the cabinet. Take care to avoid damaging the refrigerant circuit pipe work on the rear.



### STEP 3

Level the fridge freezer by adjusting the front feet. This will stop rocking or vibration and keep the door aligned.

NB. The spanner is for illustration only and is not supplied with the fridge freezer.



### STEP 4

Before plugging in and switching on, leave the fridge freezer in its final location for at least 15 minutes to allow it to settle.



### STEP 5

Plug in and switch on. Allow the fridge freezer compartments to cool before placing food inside.

All food in the fridge freezer should be covered.



#### What the display will show as both compartments cool:

##### Stage 1: Freezer

The display will show temperature reading with the freezer High Temperature symbol on.



The freezer High Temperature symbol will stay on until the freezer compartment has cooled to its factory setting (-18°C).

##### Stage 2: Freezer

The display will show arrow indicating the temperature is cooling down, until -18°C is reached, the arrow then turns off.



##### Stage 3: Fridge

The display will show temperature reading with arrow indicating the fridge compartment is cooling to its factory setting (4°C). When 4°C is reached the arrow turns off.



### STEP 6

If you are freezing fresh food, turn on *Fast Freeze* by pressing the switch 24 hours before placing the food inside.



Place the fresh food inside. *Fast freeze* will automatically cancel after 48 hours.

#### What the display will show as the Freezer compartment cools if *Fast Freeze* is pressed:

##### Stage 1:

When *Fast Freeze* is pressed.



##### Stage 2:

After 8 seconds the display will show temperature reading with the freezer High Temperature symbol on.



##### Stage 3:

Freezer compartment is set to *Fast Freeze*. The freezer High Temperature symbol has turned off.



### NOTE:

See CONTROLS section to find out how to change the display or change compartment temperatures.

### STEP 7

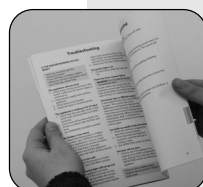

Your fridge freezer is now working. If after 24 hours your fridge freezer is not operating as you want, refer to the Troubleshooting section.

# For Your Safety

## For your safety, read the following advice:

The fridge freezer cooling system contains a small amount of gas which is environmentally friendly but flammable. To avoid any risk :-

- Install the fridge freezer following the installation instructions and ensure that ventilation openings are kept clear of obstruction.
- Take care when installing or moving the fridge freezer to avoid damaging the pipes on the rear.
- If you suspect a leak, do not switch on the fridge freezer, but open the windows and doors to ventilate the room.
- Do not use any electrical devices inside the freezer, for instance for defrosting.
- Do not use any mechanical devices for defrosting other than any which may have been supplied with the freezer, as they may cause damage.
- Only use this fridge freezer for storing domestic foodstuffs.

## When installing your fridge freezer :-

- Ensure that the mains cable is not trapped underneath or behind the fridge freezer when you install or move it.
- Do not stack any other appliance on top of this fridge freezer as they may damage the fridge or become unstable.

## When using your fridge freezer :-

- Do not sit or stand on top of your fridge freezer.
- Do not store poisonous, flammable or dangerous substances in your fridge freezer.
- Do not use aerosol sprays for defrosting or cleaning your fridge freezer.

If you sell the fridge freezer, pass on this booklet to the new owner.

# Installation

## Location & Air Circulation

Locate your fridge freezer away from sources of heat e.g. cookers, radiators, direct sunlight as extreme temperature will affect its performance.

Allow a minimum 100mm (4 inches) between the top of the fridge freezer and the ceiling or the underside of a wall cupboard.

Providing you follow the recommended ventilation requirements you will :-

- Prolong the life of the fridge freezer.
- Minimise the risk of condensation on the outside of the fridge freezer.
- Minimise the running costs.
- Minimise operating sounds caused by vibration.

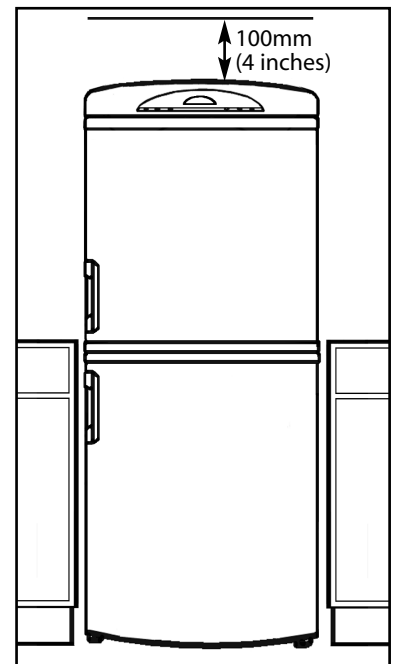

## Minimum space required to open door

The fridge freezer needs a space of 600mm (24 inches) in front to allow the door to open.

When positioning the fridge freezer next to a unit, a gap of 30mm (1¼ inch) can be left at the hinge side of the door to allow the easy removal of furniture. If preferred the fridge freezer can be positioned so that a gap is not left. This will restrict how far the door can be opened but the furniture can still be removed (see diagrams below). The door hinge side can be changed to make it easier to open (see 'Door Reversal' in the CLEANING & MAINTENANCE section).

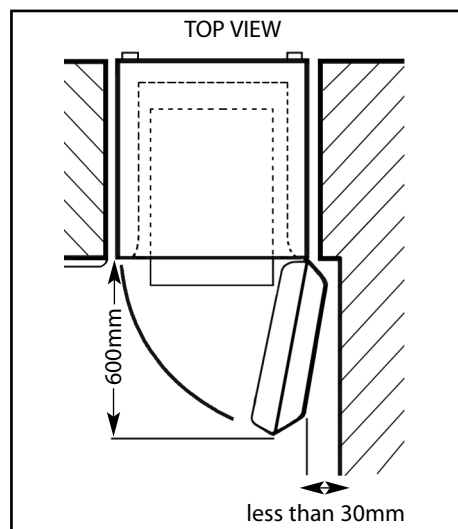
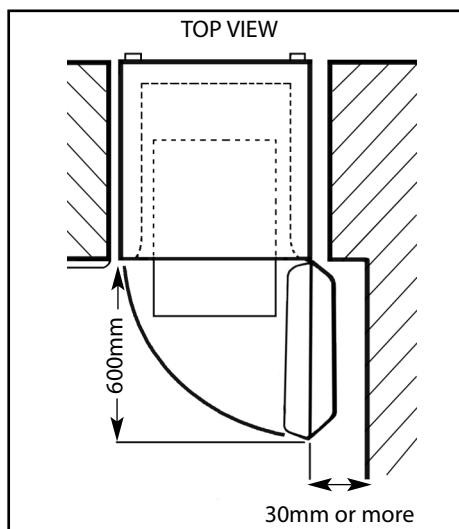

# Installation

## Levelling:

Level the fridge freezer when it is in its final location by adjusting the front feet, until firm contact is made with the floor. This will stop rocking or vibration and keep the door aligned which helps the fridge freezer run reliably and efficiently.

**Note: Before plugging in and switching on, leave the fridge freezer standing in its final location for at least 15 minutes to allow it to settle.**

**WARNING:** Failure to level the appliance correctly may result in misalignment of the cabinet and/or doors.

## Bottle Retainer:

To fit the bottle rack retainer:

Locate the retainer groove at one end of the bottle rack and then gradually press down along the top edge until the retainer is fully in the home position.

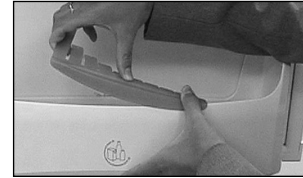

# Installation

## Electrical Supply

**WARNING:** This appliance must be earthed.

**The appliance must be positioned so that the plug is accessible after installation.**

## Fuses

Your appliance comes fitted with a plug and a 13A fuse. If you need to replace the fuse, only use those rated at 13A and ASTA approved to BS1362.

## Changing the Plug

Cut off and dispose of the supplied plug if it does not fit your socket.

**WARNING:** To avoid a shock hazard do not insert the discarded plug into a socket anywhere else.

IMPORTANT WIRES IN THE MAINS LEAD ARE COLOURED IN ACCORDANCE WITH THE FOLLOWING CODE :

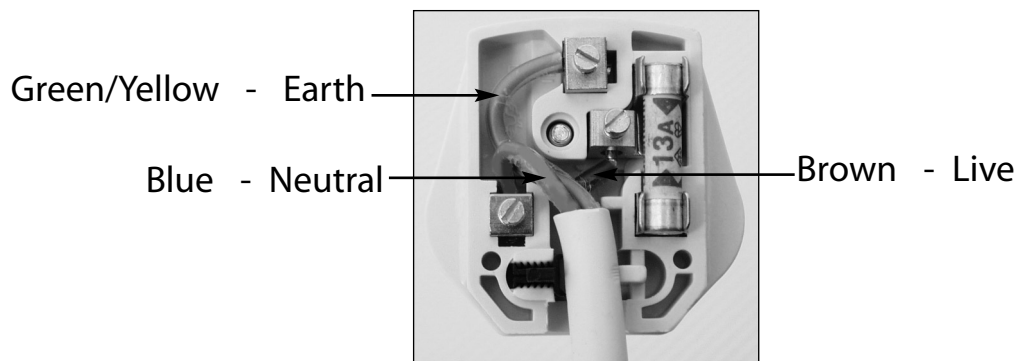

If you change the plug, the colour of wires in the mains lead may not correspond with the colour of the markings identifying terminals in the plug. You should therefore wire it as shown above.

## Changing the Mains Lead

This appliance is fitted with a special mains lead. If you need to replace the mains lead due to damage, one can be bought from Hotpoint Service (see KEY CONTACTS, back page). It is strongly advised that this work is carried out by a qualified electrician.

**CE** CE Marking certifies that this appliance conforms to the following EEC directives : Low Voltage Equipment - 72/23/EEC & 93/68 EEC  
Electromagnetic Compatibility 89/336/EEC, 92/31/EEC & 93/68/EEC

# Controls



## What the display shows during normal operation:

Fridge (top compartment): with temperature setting at 4°C



Flashing downwards arrow shows the fridge compartment is warming to reach 4°C.

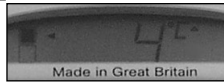

Flashing upwards arrow shows the fridge compartment is cooling to reach 4°C.



No arrow shows the fridge compartment is at 4°C.

**Note: The temperature displayed is the average temperature for the compartment, some sections will be slightly warmer or colder.**

**The arrows will only be displayed if the temperature drifts, possibly due to the door being opened, warm food being placed inside or a selected change in the temperature setting.**

## Controlling the Temperature of the Fridge or the Freezer Compartment



- Use the *Compartment Select* button to choose either the fridge compartment or the freezer compartment.
- Press the *Temp Change* button to select a different temperature for the compartment. The temperature will decrease, getting 1°C colder for each press of the button, until the required setting is reached or the coldest possible setting is reached (2°C for the fridge compartment and -25°C for the freezer compartment).
- Once the coldest possible setting is reached, pressing the *Temp Change* button again will return the temperature selection to the maximum setting (6°C for the fridge compartment and -18°C for the freezer compartment).

**Note: The display light will come on when you press any button and it will stay on for 12 seconds.**

## Temperature Indicator (not applicable to all models)

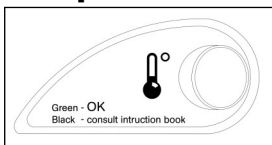

The temperature indicator is located on the bottom right hand side of the fridge compartment wall.

This indicator shows when the fridge compartment of your fridge freezer is operating at the correct temperature.

After plugging in and switching on PLEASE WAIT 24 HOURS for the fridge compartment temperature to stabilise. After this time the indicator should clearly show OK and that indicates the fridge compartment is operating at the correct temperature.

If the indicator is completely black, the compartment temperature is too high and you should adjust the temperature to a colder setting (see above).

If you have to adjust the temperature setting please WAIT A MINIMUM OF 10 HOURS, this is time for the temperature to stabilise, before checking that the indicator is showing OK.

If large quantities of food have been added or if the fridge compartment door has been opened frequently it is normal for the temperature indicator not to show OK. WAIT A MINIMUM OF 10 HOURS before adjusting the temperature to a colder setting.

# Controls

You can check the temperature of the fridge freezer compartments by using a Fridge Freezer Thermometer available from Hotpoint Genuine Part and Accessories Mail Order Hotline (see KEY CONTACTS back page).

**WARNING:** Do not use a mercury filled thermometer, as breakage would cause a health hazard.

Your fridge freezer must NOT be placed in a room where the temperature goes below 6°C or above 38°C for prolonged periods, as the internal fridge temperature will not be maintained.

## Holiday Function

This feature allows you to set your fridge compartment to a warmer setting while you are away on holiday, to reduce running costs without affecting the freezer..



To set up holiday mode:

1. Remove any food from the fridge compartment that will deteriorate while you are away. Make sure the fridge is clean, see 'Cleaning' in the CLEANING & MAINTENANCE section.
2. Close the door.
3. Press the holiday button and the holiday 'Hd' symbol and the suitcase symbol will show in the display window.

To reset to normal operation:

1. Press the holiday button OR open the fridge door. Both holiday symbols will go out, to show holiday mode is cancelled.
2. The fridge compartment will return to the temperature setting.

**Note :** *Opening the door, pressing the holiday button or pressing any other button at any time after holiday mode has been set will turn the function off.*

## Fast Freeze Button - Freezing Fresh Food



The bottom compartment drawer, should be used to freeze fresh food. Transfer already frozen food to one of the upper compartment drawers.

During the fast freeze process the chiller bleed restrictor (refer to page 12 for illustration) should be inserted into the chiller bleed opening. This will prevent the chiller drawer and salad bins from going below their ideal storage temperatures. At the end of the fast freeze process, remove the restrictor and keep until required.

- Before loading **2kg or more** of fresh food, select fast freeze for the required pre-freeze time (see chart below).
- If freezing **up to 2kg** of fresh food just select fast freeze when loading.

Once the fresh food is loaded leave fast freeze on for 24 hours to freeze the food as quickly as possible.

Maximum freezing capacity in 24hrs: 10kg

**Note:** *Don't forget to turn fast freeze off after 24 hours from the introduction of fresh food to be frozen. However, fast freeze will turn off automatically after 48 hours if you forget.*

Pre-Freeze chart when selecting Fast Freeze:

Load for freezing	Pre-freeze time	Load position
8 to 10kg max.	24 hours	In the bottom drawer.
6 to 8kg	12 hours	In the bottom drawer.
2 to 6kg	6 hours	In the bottom drawer.
up to 2kg	not required	In the bottom drawer.

# Controls

Check the TROUBLESHOOTING section if you have any problems with these warning symbols.

## Freezer High Temperature Warning symbol and buzzer



The freezer High Temperature warning symbol will come on when the fridge freezer is first switched on, or when the temperature inside the compartment rises above the correct storage temperature. It will go out as soon as the compartment returns to its normal storage temperature. The symbol may come on for a short period when opening the freezer door to load or unload food, in this case storage times will not be affected.

A buzzer will sound when the freezer High Temperature warning symbol comes on. You can silence the buzzer by pressing the *cancel* button and the bell symbol will go out on the display. The freezer High Temperature warning symbol will remain on the display until the compartment returns to its normal storage temperature.



**Note: To avoid unnecessary concern the buzzer is automatically silenced the very first time you switch the fridge freezer on.**

If there has been a power cut resulting in a rise in freezer compartment temperature, the freezer High Temperature warning symbol will come on as soon as the mains power returns. It will go out as soon as the compartment returns to its normal storage temperature.

*Avoid opening compartment doors during a power cut, the freezer insulation will continue to protect your food. However, if the power cut continues there is a risk of your frozen food beginning to defrost due to the rise in temperature (see FOOD DEFROST ALERT below).*

## Food Defrost Alert symbol and buzzer

The Food Defrost Alert symbol will come on when the mains power has been restored after a power cut and the freezer compartment has returned to its normal storage temperature.

The Food Defrost Alert symbol will be on the display, along with a reading of the temperature the freezer compartment had risen to eg.  $-2^{\circ}\text{C}$



This warns you that there has been a power cut, during which the freezer compartment temperature rose to an unsafe level, allowing partial defrosting of stored food.

If this symbol is on the display, food should be either cooked and eaten within 24 hours, cooked and refrozen or thrown away.

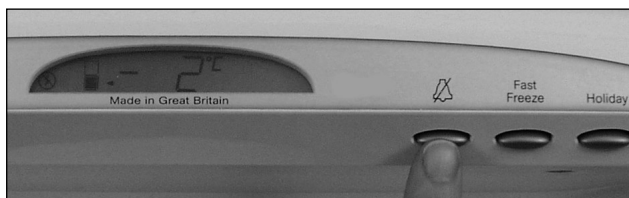

A buzzer will also sound. You can silence the buzzer by pressing the *cancel* button and the bell symbol will go out on the display.

The Food Defrost Alert symbol is a particularly useful warning if you were out at the time of the power cut. The symbol will remain on until cancelled manually by pressing the *Food Defrost Alert* button. On cancelling the Food Defrost Alert symbol, the display will revert to the normal storage temperature.





# Useful Advice



**Note:**  
**The Rating Plate, which lists the appliance Model Number and Serial Number can be found near the bottom of the freezer compartment on the interior wall.**



**Note: Care must be taken when storing food items in the top of the fridge compartment. Make sure items are not stored too close to the moulding at the rear of the compartment as very cold air enters the appliance at this point and may cause certain containers to split.**

## Making the best use of your Fridge Freezer

**Note : Always use the handle provided to open the fridge / freezer door.**

To ensure that your fridge freezer operates as efficiently as possible :

- Follow food packaging "best before/use by" instructions or your suppliers advice on a suitable maximum storage time.
- Keep foods tightly covered to retain moisture and prevent flavour/odour transference. Plastic bags, aluminium foil, plastic stretch wrap and containers with lids are ideal.
- Select chilled and frozen food last when shopping, transport in a 'cool bag' and place in freezer as soon as possible after arriving home.
- Avoid opening the doors unnecessarily or for longer than needed.
- Allow hot or warm food to cool down in covered containers before placing in the fridge or freezer, as placing hot food inside reduces efficiency.
- Prepare fresh foods for freezing in small quantities to ensure that the food freezes quickly and so that its quality does not deteriorate.
- Ensure that packets/containers of food are dry before freezing otherwise they may freeze together.

## How Frost Free works

The frost free system completely eliminates the need for defrosting.

A fan circulates air, this helps to remove moisture from the compartments, therefore preventing the build up of ice.

It is normal to hear the fan when the fridge freezer is cooling.

Additional benefits of the frost free system include:

- More even temperatures throughout the freezer.
- Faster cooling times.

# Useful Advice

## STORAGE ZONES

Zone	Type	Food Storage
A	Cold	Dairy products, Cheese, butter, margarine, Low fat spreads, cooking fats / lards Preserves - Jam, curd, marmalade, spread, salad dressing or sauces.
B	Colder	General food storage
C	Coldest	Meat fish & poultry Pre-cooked / chilled food
D	Salad Bins	Vegetables, fruit and salad items (Not recommended for the storage of bananas or onions).
E	*Chiller	Chicken, meat, fish, game.

\*The chiller works between -2°C to +3°C and will freeze food with a high water content.

## Storing Food in a Fridge

- Pack and store cooked and fresh food separately.
- Wrap raw or defrosting meat and poultry in polythene or foil and store below cooked foods and dairy products to avoid contamination of dripping food juices.
- Wrap cheese in greaseproof paper and place in an airtight container or polythene bag. Bring to room temperature before consuming.
- Empty left over canned food into a covered storage containers before placing in the fridge.
- Position food to allow cold air to circulate freely, ensuring nothing comes into contact with the back of the fridge compartment.
- Use the different storage zones inside your fridge compartment to store a wide variety of food items.
- Your freezer is designed and constructed with good door sealing to make it operate as efficiently as possible. For this reason, after closing the door, it may be difficult to open again immediately. This is not a fault. If you wait about 2 minutes for the internal and external pressures to equalise the door can be opened more easily.



**Microban**® is a unique antibacterial technology which is built into interior components of your fridge during manufacture. **Microban**® protects against growth of potentially harmful and odour causing bacteria on the interior fridge surfaces, thereby keeping your fridge fresher and more hygienically clean during use. **Microban**® will not wash out or wear out and will provide continuous protection against bacteria for the life of your fridge. **Microban**® technology has been proven safe, durable and effective over many years of use in personal care and household consumer products. In addition, Hotpoint operate a rigorous antibacterial testing programme through approved independent testing laboratories.

**Note : You should continue to clean your fridge as recommended (see CLEANING & MAINTENANCE section). Microban® provides an extra level of hygiene protection in your fridge in between cleanings.**

# Useful Advice

## Commodity and Bottle Racks

Commodity racks can be repositioned in the door to suit your storage requirements. The lidded commodity rack is recommended for the storage of dairy items, such as butter, margarine and cheese.

To remove, lift rack vertically to release from fixing supports. To replace, align grooves on either side of the rack above fixing supports and push down until secure.

In order to get the best results from the bottle retainer it is advised that it be positioned centrally on the bottle rack.

## Egg Rack

The egg rack can be used in conjunction with any commodity rack and is easily removed for cleaning.

**Note: Wipe, don't wash eggs.**

## Advice on Adjusting Shelves

Make the most of the interior storage space by repositioning shelves to suit the various heights of individual items you wish to store.

To remove, ensure that the door is open fully. Slide the shelf forward and tilt from position.

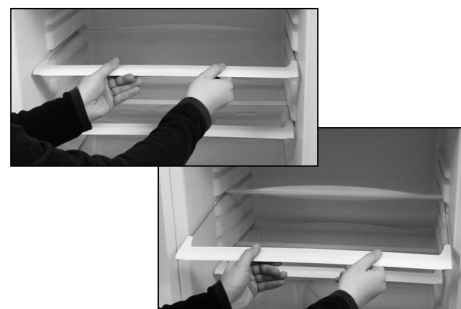

## Split Glass Shelf



The split shelf can be used as a standard shelf but also as two half shelves. The front half can be repositioned above or below to enable storage of larger items.



**Note : Only the front half of the shelf can be repositioned, the back half must remain in its original position.**

## Wine Rack

The wine rack is suitable for cans, wine bottles and 2 litre bottles. The maximum load recommended is three 2 litre bottles and two wine bottles.

Position the wine rack in the second runner down from the top of the fridge when storing longer length bottles. This will ensure the bottles clear the door furniture and allow the door to close properly.

To remove:

Ensure that the fridge door is fully open. Slide the wine rack forward and tilt from position.

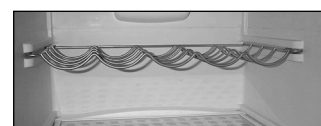

**Note: DO NOT remove a fully loaded wine rack, just remove bottles as necessary.**

# Useful Advice

## Salad Bins

For the storage of fruit, vegetables and salad items.

When storing vegetables, remove unusable leaves and soil. Leave lettuce, cabbage and cauliflower on the stem.

It is advisable to clean the salad bin regularly, it can be removed by sliding it out from position.

**Note : Care must be taken to ensure that the salad bin is pushed in fully before shutting the fridge door.**

## Humidity Control

Each salad bin has its own humidity control, which can be adjusted to retain the freshness of either fruit or salad being stored. Just slide the humidity controls to open and close the vents.

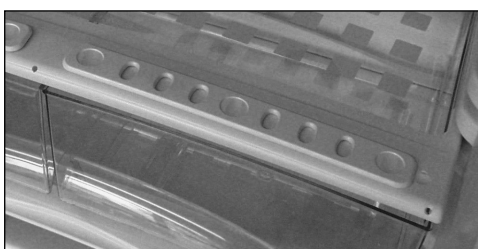

It is recommended that salad is stored at high humidity (vents closed).

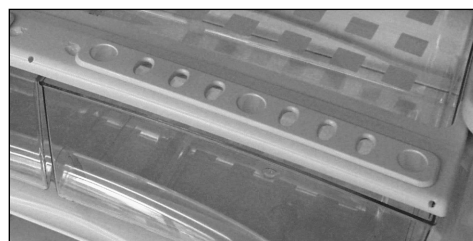

It is recommended that fruit is stored at low humidity (vents open).

## Chiller Drawer

The chiller drawer maintains cold temperatures and is suitable for the storage of chicken, meat, fish and game etc.

**Note : This compartment is not suitable for the storage of foods with a high water content eg. salad.**

Should you feel that the temperature in the chiller drawer is too cold or you wish to use this area for unchilled produce you can insert the chiller bleed restrictor to raise the temperature in this area.

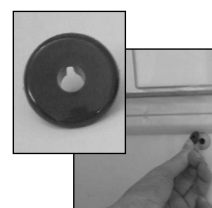

To remove the flap and chiller drawer for cleaning:

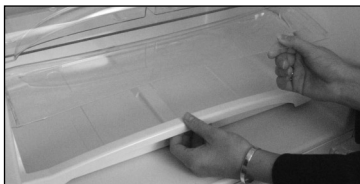

- Lift the flap fully open and simply pull the drawer towards you to remove.

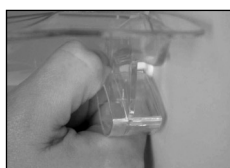

- Lift the flap and squeeze the plastic edges beneath the flap on either side.



- Carefully push the flap forward and down to release it from the holding pins and remove.

**Note : It may be necessary to remove some items, eg. cooked meats, a short time before serving.**

# Useful Advice

## STORAGE GUIDE

Frozen Food Storage Capacity	31kg
Maximum Freezing Capacity in 24 hours	10kg
Maximum Conservation Time from Failure	16 hours

## Storing Food in a Freezer

- Freeze and store either fresh food or long term commercially frozen foods.
- Generally speaking long term storage means up to 3 months but this can vary, so always follow your supplier's recommendations otherwise refer to the pictorial guide on the door liner (as shown).
- Place frozen food in the freezer compartment as soon as possible after buying it.
- Liquid-filled bottles or sealed fizzy drinks must not be stored in freezer, as they may burst.
- Lollipops and water ices should not be given to children directly from the freezer the low temperature may cause 'freezer burns'.
- Store ice cream towards the top front of the freezer and remove from freezer 15-30 minutes before serving.
- Ensure food is labelled and dated before placing in freezer.
- When freezing fresh food follow the instructions for using fast freeze (see CONTROLS section).
- Do not allow fresh food to come into contact with food already frozen, the frozen food could start to defrost.
- Once thawed, food should be cooked and eaten within 24 hours or cooked and refrozen.

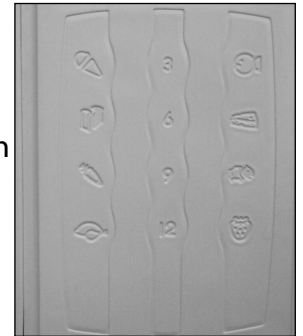

# Useful Advice

## Advice on Using Freezer Drawers

The freezer compartments must be used with the drawers.

The storage drawers can be easily removed. Pull the drawer towards you until it reaches its stop position. Hold securely on both sides, lift the front of the drawer to release and remove. For cleaning advice see CLEANING & MAINTENANCE section.

Ensure that the frozen food storage drawers are pushed back fully before closing the door. Food can be separated into different storage drawers for easy identification.

When lifting or removing the large deep drawer it is important to hold the side handles and not the front handle.

**WARNING:** The freezer drawers can become heavy when fully loaded with food. Care must be taken if attempting to lift or carry a full freezer drawer. It is recommended to remove the required food, rather than the whole freezer drawer.

**Note :** *It is important not to touch or move any of the freezer drawers/parts with wet hands as it may cause freezer burn or discomfort.*

## Ice Tray

When making ice always use the tray with the lid provided. Take care not to overfill with water. Uncovered food should not be placed near the ice tray as it can affect the flavour of the ice.

**Note :** *Empty, wash and refill the ice tray periodically to ensure freshness.*

# Cleaning

**WARNING:** Switch off electrical supply and pull out mains plug before cleaning.

## Interior

**WARNING:** Do not use abrasive powder, household cleaner, bleach or wax polish to clean the interior, they will leave a smell inside the fridge freezer.

1. Remove stored food and wrap or cover it and place into insulated containers to keep it cool/frozen whilst cleaning.
2. Remove salad bins, racks, shelves and drawers from each compartment. Wash in warm water and washing up liquid using a soft cloth, dry thoroughly. DO NOT use any cleaning agents on the wine rack, just wipe with a soft cloth.
3. Wipe interiors and fittings with a clean cloth wrung out in a solution of either one teaspoon of bicarbonate of soda to one pint of water or Milton™ sterilising fluid, diluted according to the manufacturer's instructions.
4. Dry interior compartments thoroughly with a clean cloth before replacing fittings and food.  
**Note : It is important to ensure that cleaned shelves, racks, drawers and bins are thoroughly dried before refitting into the fridge freezer compartments.**

## Exterior

**WARNING:** Do not use abrasive powder, household cleaner or bleach, they can damage the exterior of your fridge freezer.

1. Use a clean soft cloth wrung out in warm water and washing up liquid to wipe the exterior surface, dry thoroughly.
2. Use a soft brush or vacuum cleaner to remove dust from underneath the fridge freezer and from the compressor and condenser situated at the back of the fridge freezer.

**WARNING:** Do not damage the pipework.

## Door Seals

Use warm water and a clean soft cloth to wipe along and in between the creases of the door seals, dry thoroughly. Take care not to damage the seals and avoid using sharp objects.

**WARNING:** Do not use detergent, it will damage the seals.

# Maintenance

## Going Away

If you are going away and don't want to use your fridge freezer, switch off electricity supply and pull out the mains plug. Remove food and follow the cleaning instructions on the previous page.

**Note : Leave the doors ajar to prevent an accumulation of odours.**

Alternatively, if you want to keep your freezer running but want to empty the fridge you could set the holiday mode. See CONTROLS section.

## Changing the Light Bulb

**WARNING:** Switch off electricity supply and pull out the mains plug

Obtain a replacement SES 15 watt bulb from the Hotpoint Genuine Parts and Accessories Mail Order Hotline (see KEY CONTACTS back page) and fit as follows :

1. Remove any shelves from directly below the interior light, to make access easier.
2. Squeeze the sides of the lamp guard lightly to unclip. Remove and retain.
3. Remove old bulb and fit new one.
4. Refit lamp guard.
5. Plug in and switch on electrical supply.



# Door Reversal

You will need a selection of small hand tools, screwdrivers, spanners etc. to carry out this procedure. Our Service Department can arrange for an Engineer to do the conversion for you but a charge will be made.

**WARNING:** Switch off electrical supply and pull out the mains plug.

Remove all door furniture and all loose items/fittings from inside the fridge freezer.

If you have previously set up and used the fridge freezer and since decided to reverse the doors, you must remove stored food, wrap or cover it and place into insulated containers to keep cool/frozen whilst carrying out this operation.

## Remove Top Door

1. Open the door as wide as possible.  
**Note : You may require assistance to do this:**
2. Support the door and using a screwdriver, remove the screw securing the top hinge.
3. Lower the top hinge and carefully tilt the door to remove the top hinge from the cabinet. Lift the door off the centre hinge.
4. Remove the top hinge from the door.



## Remove Lower Door

5. Open the lower door and while supporting the door, remove spacing washers and pin from the centre bracket. *Note which way up the pin is fitted.*
6. Lift the door off the bottom hinge.

7. Take the two screw covers off the centre hinge.



8. Unscrew the two screws to remove the centre hinge.

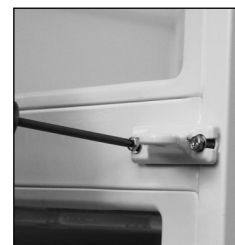

9. Remove any spacing washers fitted to the bottom hinge and store safely. Using the packaging from the appliance or a suitable substitute to support the back of the appliance. Lay the appliance on its back, ensuring the pipework at the back is not damaged or bent.

**Note : Be careful that the appliance does not run away from you when the wheels touch the floor.**

10. Unscrew the foot and hinge bracket fitted to the bottom right hand side of the appliance. Unscrew the foot and footplate fitted to the bottom left hand side of the appliance. Refit the hinge bracket and the footplate to the opposite sides of the appliance. Screw in the feet until there is approximately 35mm projecting from the bottom front edge of the appliance.

**Note : You may require assistance to do this:**

11. Lift the appliance onto its feet. Lift the appliance from the rear of the tabletop and stand it on its feet and wheels.  
**Note : Be careful that the appliance does not run away from you when the wheels touch the floor.**  
Refit the spacing washers.

# Door Reversal

## Door Handle Reversal

12. Remove the hole plugs from the right hand side of the door.
13. Unscrew the handle fixing screws and carefully remove the handle from the door.
14. Turn the handle vertically, top to bottom and place against the right hand side.
15. Secure the handle in place with the original fixing screws.
16. Use the hole plugs removed from the right hand side to fill the holes on the left.

## Refit Lower Door

17. Take off the two screw covers from the left hand centre panel and remove the two screws. Fit these screws and covers over on the right hand side.
18. Fit the centre hinge on the left hand side with the original screws and cover the screws with the original covers.
19. Using a thin blunt instrument, remove the hinge bush cap from the top left of the lower door and fit on the top right.  
**Note : You may require assistance to do this:**
20. Place the lower door onto the lower hinge pin.
21. Offer the door up to the centre hinge and ensure it locates into the door. Check that the hinge pin is positioned the right way up.



## Refit Top Door

22. Using a thin blunt instrument, remove the hinge bush cap from the top left of the door and refit on the top right.
23. Replace the spacing washers onto the centre hinge bracket.  
**Note : You may require assistance to do this:**
24. Place the top hinge onto the top left of the door, slide the door onto the centre hinge pin. Support the door while screwing the top hinge into position. Ensure that the hinge bracket locates correctly.
25. If necessary, slacken off the screws on the centre hinge pin and adjust the doors so that they line up with the cabinet.
26. Adjust the front feet (see 'Levelling' SAFETY & INSTALLATION section).  
**WARNING:** Failure to level the appliance correctly may result in misalignment of the cabinet and/or doors.



**Note : Let the appliance stand upright in it's final location for at least 15 minutes before plugging in and switching on the electricity supply.**

# Troubleshooting

## IS THE FRIDGE FREEZER WORKING AS YOU WANT?

Have you read through the instruction book ?  
If you still have a problem, before calling our service organisation see if any of the tips below help.

### The fridge freezer will not work?

1. Check plug is firmly positioned in the socket outlet and the power supply is switched on.
2. Check power supply with another appliance.
3. Check fuse/circuit breaker.
4. Check the door is closed properly.

### The fridge freezer is making a lot of noise?

1. Check that the rear pipe work is clear of the wall, skirting board and other obstacles.
2. Check that all feet/wheels are firmly in contact with the floor and the fridge freezer is level.
3. See OPERATING SOUNDS next page.

### The temperature is too warm?

1. Adjust the temperature setting.  
See CONTROLS section.
2. If the fridge freezer is close to a heat source, move it to another location.
3. Check that there is enough ventilation around the fridge freezer.
4. Check that the door has been closed properly.

### The temperature is too cold?

Adjust the temperature setting.  
See CONTROLS section.

### A buzzer is sounding / the High Temperature warning symbol will not go out?

1. Has the fridge freezer just been installed?
2. Has the fridge freezer been loaded with a large quantity of food?
3. Have the doors been closed properly?
  - All the above points affect the internal temperature and the symbol will go out when the correct temperature has been reached.
  - Press the cancel buzzer button to silence the buzzer.

### The High Temperature warning symbol is on but there is no buzzer?

1. To avoid unnecessary concern, the buzzer will not sound the very first time you switch on the fridge freezer.
2. The buzzer cancel button has been pressed (no bell symbol in the display).  
See CONTROLS section.

### The display shows FF?

Fast freeze is selected. Remember to turn fast freeze off after 24 hours from the introduction of fresh food to be frozen. However, it will automatically cancel after 48 hours, if you forget.

### The holiday symbols are on the display?

Holiday mode is selected.

Press the holiday button or open the fridge door to cancel this function and return the fridge freezer to normal operation.

### The holiday mode setting won't stay on?

The holiday mode setting can only be set when the door is closed.

Opening the door or pressing any other button will turn holiday mode off.

See CONTROLS section.

### The interior light doesn't work?

**WARNING:** Switch off the electricity supply and pull out the mains plug.

- Check the bulb is screwed in correctly. If still not working then see 'Changing the Light Bulb' in the CLEANING & MAINTENANCE section.

### The freezer door is difficult to open?

If you have just closed the door it may be difficult to open again immediately. This is a sign of a good door seal and is not a fault. Wait 2 minutes for the internal and external pressures to equalise and try again.

### There has been a power failure / A buzzer is sounding?

**WARNING:** Do not open the freezer compartment door.

- When power is restored the High Temperature warning symbol will be on the display. This will go out when normal storage temperature is reached and stored food will be unaffected.
- When the normal storage temperature has been reached, the Food Defrost Alert symbol will show in the display **if** the power failure lasted longer than the maximum conservation time, resulting in the freezer compartment temperature warming allowing partial defrosting of the food stored. In this case, food should either be cooked and eaten within 24 hours, cooked and refrozen or thrown away.

Press the *cancel* button at any time to silence the buzzer, the bell symbol will go out on the display.  
See CONTROLS section.

If there is still a problem contact Hotpoint Service (See KEY CONTACTS, back page, for contact details).

continued...

# Troubleshooting

## OPERATING SOUNDS OF A FRIDGE FREEZER

These are the normal types of sound that your fridge freezer will make:

- The fridge freezer motor (compressor) makes a buzzing or humming sound when it is running. This can be louder when it is first switched on. This sound will reduce over the first few months.
- Gases flowing through the pipes can produce gurgling, bubbling, roaring or humming noises.
- Expansion and contraction of parts inside the fridge freezer can produce a cracking noise as they rapidly change temperature.
- The circulating fan can make a whirring or buzzing sound as it blows cold air around the compartments.
- A valve at the top of the fridge, that allows cold air into the compartment can make a whirring sound as it opens or closes.

# Notes



## Guarantee

### “Satisfaction guaranteed or your money back”

We give you a unique ‘satisfaction guaranteed’ promise - **valid for 90 days** - after you have purchased your Hotpoint appliance. If there is a technical problem simply call Hotpoint Repair service or visit our web-site at [www.hotpointservice.co.uk](http://www.hotpointservice.co.uk) and where necessary, we will arrange for an engineer to call. If the technical problem is not resolved under this guarantee **we will replace your machine or, if you prefer, give you your money back.**

All Hotpoint appliances carry a fully inclusive 12 month parts and labour guarantee as well as free replacement parts for the first 5 years (except microwaves, selected integrated appliances and cooker hoods, which have a one year guarantee) provided that they are fitted by a Hotpoint engineer.

### Guarantee terms and conditions

Your guarantee is only applicable in the United Kingdom or Republic of Ireland and is subject to the following provisions that your appliance:

- ◆ Has been installed and used correctly in accordance with this instruction booklet.
- ◆ Has been used solely for domestic purposes and is located on domestic premises (ie. not for commercial or trade use).
- ◆ Has been properly connected to a suitable electrical supply voltage as stated on the appliance rating plate.
- ◆ Has not been subject to misuse, accident, modified or repaired by anyone other than one of our own service engineers.



For pre purchase information on any other Hotpoint product call: 08701 50 60 70  
or visit: [www.hotpoint.co.uk](http://www.hotpoint.co.uk)

### Disposal of old electrical appliances

The European Directive 2002/96/EC on Waste Electrical and Electronic Equipment (WEEE), requires that old household electrical appliances must not be disposed of in the normal unsorted municipal waste stream. Old appliances must be collected separately in order to optimise the recovery and recycling of the materials they contain and reduce the impact on human health and the environment.



The crossed out “wheeled bin” symbol on the product reminds you of your obligation, that when you dispose of the appliance it must be separately collected.

Consumers should contact their local authority or retailer for information concerning the correct disposal of their old appliance.



## Recycling & Disposal Information

As part of Hotpoint’s continued commitment to helping the environment, Hotpoint reserves the right to use quality recycled components to keep down customer costs and minimise material wastage.

Please dispose of packaging and old appliances carefully. Old refrigerant and oil must be disposed of in a safe and environmentally friendly manner, using suitably qualified personnel.

To minimise risk of injury to children, remove the door, plug and cut mains cable off flush with the appliance. Dispose of these parts separately to ensure that the appliance can no longer be plugged into a mains socket, and the door cannot be locked shut.



## After Sales Service

**“No company is better positioned to offer an after sales service on a Hotpoint appliance than us - the manufacturer”**

As part of our commitment to you, all Hotpoint appliances have the added benefit of a fully inclusive parts and labour guarantee for the first 12 months. In addition to this you also have the advantage of **free replacement parts for the first 5 years** when fitted by a Hotpoint engineer. When the 12 months parts and labour guarantee expires we offer the following after sales service options:

### **Repair Service and Information Help Desk**

UK: 08709 066066

[www.hotpointservice.co.uk](http://www.hotpointservice.co.uk)

Republic of Ireland: 1850 302 200

Note: Our operators will require the Model number and the Serial number of your appliance (see USEFUL ADVICE SECTION for rating plate position).

Available 364 days a year with a fast, effective and value for money service. We have the largest white goods repair service in the UK with over 1100 of our own fully trained engineers. All repairs include a parts and labour guarantee for 12 months from the date of the repair.

If you require any information or have any questions about your appliance, our operators are on hand with help and advice.

All this ensures that you will receive the best available after sales service possible.

### **Extended Warranties**

UK: 08709 088 088

[www.hotpointservice.co.uk](http://www.hotpointservice.co.uk)

Republic of Ireland: 1850 502 200

Whether you have just one or a number of Hotpoint appliances in your kitchen, we offer two service cover plans to give you total peace of mind.

- ◆ Repair Protection Plan - FREE service repairs for a single Hotpoint appliance during the period of cover.
- ◆ Kitchen Cover - FREE service repairs for all your Hotpoint appliances less than 8 years old.

### **Genuine Parts and Accessories**

UK: 08709 077 077

[www.hotpointservice.co.uk](http://www.hotpointservice.co.uk)

Republic of Ireland: (01) 842 6836

A wide range of genuine parts and accessories are available from our hotline or through our web site.

**Genuine parts and accessories, extended warranties and service repairs are all available on our web-site at:**

[www.hotpointservice.co.uk](http://www.hotpointservice.co.uk)



## Key Contacts

### After Sales Service

Over 1100 trained specialists, directly employed by us, ensure that you can have complete confidence in both the appliances and services we offer.

#### Repair Service and Information Desk

UK: 08709 066 066  
Monday to Friday, 8am to 7.30pm  
Saturday, 8.30am to 5.30pm  
Sunday, 9.30am to 3.30pm  
[www.hotpointservice.co.uk](http://www.hotpointservice.co.uk)

Republic of Ireland: 1850 302 200

Note: Our operators will require the following information:

Model number:

Serial number:

See USEFUL ADVICE SECTION for rating plate position

#### Extended Warranties

UK: 08709 088 088  
Monday to Sunday, 8am to 8pm  
[www.hotpointservice.co.uk](http://www.hotpointservice.co.uk)  
Republic of Ireland: 1850 502 200

#### Genuine Parts and Accessories

UK: 08709 077 077  
Monday to Friday, 8.30am to 5pm  
Saturday, 8.30am to 12noon  
[www.hotpointservice.co.uk](http://www.hotpointservice.co.uk)  
Republic of Ireland: (01) 842 6836

[www.hotpoint.co.uk](http://www.hotpoint.co.uk)

**Indesit** Company UK Limited, Morley Way, Peterborough, PE2 9JB