

Rinnai

Operation / Installation Manual

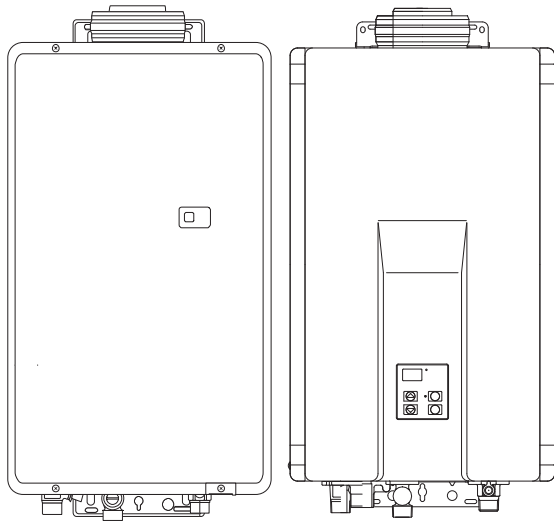

To Suit Models:

REU-V2520FFU.....	R53
REU-V2520FFUC.....	C53
REU-V2532FFU.....	R85
REU-V2532FFUC.....	C85
REU-V2520FFUD.....	R53PLUS
REU-V2520FFUCD...	C53PLUS
REU-V2532FFUD.....	R85PLUS
REU-V2532FFUCD...	C85PLUS

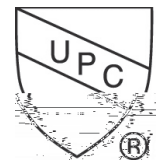

(Residential and Commercial indoor unit)

ANS Z21.10.3 • CSA 4.3

WARNING: If the information in these instructions is not followed exactly, a fire or explosion may result causing property damage, personal injury or death.

- Do not store or use gasoline or other flammable vapors and liquids in the vicinity of this or any other appliance.
- **WHAT TO DO IF YOU SMELL GAS**
 - Do not try to light any appliance.
 - Do not touch any electrical switch; do not use any phone in your building.
 - Immediately call your gas supplier from a neighbor's phone. Follow the gas supplier's instructions.
 - If you cannot reach your gas supplier, call the fire department.
- Installation and service must be performed by a qualified installer, service agency or the gas supplier.

SPECIFICATIONS

Model		V2532FFU V2532FFUD	V2532FFUC V2532FFUCD	V2520FFU V2520FFUD	V2520FFUC V2520FFUCD
Minimum Gas Consumption Btu/h		15,000			
Maximum Gas Consumption Btu/h		180,000			
Hot water capacity, (50°F rise)		0.6 to 6.5 GPM		0.6 to 5.3 GPM	
Hot water capacity, (35°F rise)		0.6 to 8.5 GPM		0.6 to 5.3 GPM	
Default Temperature Setting (no controller)		120°F	140°F	120°F	140°F
Controller Default Temperature Setting		104°F	140°F	104°F	140°F
Maximum Temperature Setting		140°F	185°F	140°F	185°F
Minimum Temperature Setting		98°F			120°F
Weight		49 Lbs.			
Efficiency Rating		87%			
Noise level		49 dB (A)			
Electrical Consumption	Normal	75 watts			
	Standby	5.5 watts			
	Anti-frost Protection	100 watts			
By-Pass Control		Electronic		Fixed	None
Minimum Gas Supply Pressure	Natural Gas	6" W.C.			
	Propane	10" W.C.			
Maximum Gas Supply Pressure	Natural Gas	10.5" W.C.			
	Propane	13.5" W.C.			
Type of Appliance		Temperature controlled continuous flow gas hot water system.			
Operation		With or without remote controls, mounted in kitchen, bathroom, ect.			
Exhaust System		Direct Vent - Forced Combustion			
Approved Gas Type		Natural Gas or Propane - Ensure unit matches gas type it's being installed on.			
Connections		Gas Supply: 3/4" MNPT, Cold Water Inlet: 3/4" MNPT, Hot Water Outlet: 3/4" MNPT			
Ignition System		Direct Electronic Ignition			
Electric Connections		Appliance: AC 120 Volts, 60Hz.		Remote Control: DC 12 Volts (Digital)	
Water Temperature Control		Simulation Feedforward and Feedback.			
Water Supply Pressure		Minimum Water Pressure: 20 PSI (Recommended 30-80 PSI for maximum performance)			
Maximum Water Supply Pressure		150 PSI			
Remote Control Cable		Non-Polarized Two Core Cable			
Safety Devices		Flame Failure - Flame Rod			
		Boiling Protection - 210°F			
		Remaining Flame (OHS) 207°F Bi-Metal Switch			
		Thermal Fuse 264°F			
		Automatic Frost Protection - Bi-Metal Sensor & Anti-Frost Heaters			
		Combustion Fan RPM Check - Integrated Circuit			
		Over Current - Glass Fuse (3 amp)			

NOTE: Rinnai is continually updating and improving products, therefore, specifications are subject to change without prior notice. Local, state, provincial and federal codes must be adhered to prior to installation.

LIMITED WARRANTY

Rinnai Water Heater

Warranty031705COMM-V2

WHAT IS COVERED?

This Warranty covers any defects in materials or workmanship when the product is installed and operated according to Rinnai written installation instructions, subject to the terms within this limited warranty document. This Warranty applies only to products that are installed by a state qualified or licensed contractor. Improper installation may void this Warranty. Rinnai strongly suggests that you use an installer who has attended a Rinnai product knowledge class before installing this water heater. This Warranty extends to the original purchaser and subsequent owners, but only while the product remains at the site of the original installation. This Warranty only extends through the first installation of the product and terminates if the product is moved or reinstalled at a new location.

HOW LONG DOES COVERAGE LAST?

Item	Period of Coverage	
	Commercial	Residential
Heat Exchanger	5 Years*	10 Years*
All other Parts and Components	5 Years*	5 Years*
Reasonable Labor	1 Year	

*Important

Period of coverage is 3 years from date of purchase when used as a circulating water heater within a hot water circulation loop, when the water heater is in series with a circulation system and all circulating water flows through the water heater.

WHAT WILL RINNAI DO?

Rinnai will repair or replace the product or any part or component that is defective in materials or workmanship, except as set forth below: Rinnai will pay reasonable labor and shipping costs to repair the product. All repairs must be performed using genuine Rinnai parts. All repairs or replacements must be performed by an individual or servicing company that is properly trained, state qualified or licensed to do this type of repair.

Replacement of the product or replacement of the heat exchanger may be authorized by Rinnai only. Rinnai does not authorize any person or company to assume for it any obligation or liability in connection with the replacement of a product or heat exchanger. If Rinnai determines that repair of a product is not possible, Rinnai will replace the product with a comparable product, at Rinnai's discretion. If a component or product returned to Rinnai is found to be free of defects in material or workmanship, or damaged by improper installation or damaged during return shipping, the warranty claim for product, parts and labor may be denied.

LIMITED WARRANTY

Rinnai Water Heater

Warranty031705COMM-V2

HOW DO I GET SERVICE?

Simply contact a qualified Service Dealer or Installer for the repair of products under this Warranty. **Failure to use a qualified Service Dealer or Installer to provide repair service may void the Warranty.** For the name of the qualified Service Dealer or Installer nearest you, please contact the company that installed the water heater, or;

- Your local HVAC/plumbing dealer, gas service technician or place of purchase
- Visit the Rinnai website www.rinnai.us
- Call Rinnai at 1-800-621-9419 or write to Rinnai, 103 International Drive, Peachtree City, Georgia 30269

Proof of purchase is required to obtain warranty service. You can show proof of purchase with a dated sales receipt, by completing and mailing the enclosed Warranty registration card within 30 days of purchasing the product or by registering online at www.rinnai.us . **Please complete the Warranty registration either online or mail it to Rinnai at the address shown on the card.**

Receipt of warranty registration by Rinnai will constitute proof-of-purchase for this product. However, Warranty registration is not necessary in order to validate this Warranty.

WHAT IS NOT COVERED?

This Warranty does not cover any failures or operating difficulties due to accident, abuse, misuse, alteration, misapplication, acts of God, improper installation, improper maintenance or service, inadequate water quality, scale buildup, freeze damage or for any other causes other than defects in materials or workmanship. This warranty does not apply to any product whose serial number or manufacture date has been defaced. This Warranty does not cover any product when used as a pool or spa heater. (See Water Quality in Care & Lime Section.)

Rinnai is not liable for any special, incidental, indirect or consequential damages that may arise, including damage to person or property, loss of use, failure to install drain pan under unit, or inconvenience. Some states do not allow the exclusion or limitation of incidental or consequential damages, so the above limitation may not apply to you.

LIMITATION ON IMPLIED WARRANTIES

Any implied warranties of merchantability and fitness arising under state law are limited in duration to the period of coverage provided by this limited Warranty, unless the period provided by state law is less. Some states do not allow limitations on how long an implied Warranty lasts, so the above limitation may not apply to you.

This Warranty gives you specific legal rights, and you may also have other rights which vary from state to state.

C O N T E N T S

Specifications.....	2
Limited Warranty.....	3,4
Owner's Installation Information	6
Features of Your New Water Heater.....	7
Safety Issues.....	8
Basic Operation	9
About Hot Water.....	10
Scalds-First Aid.....	10
General Controller Information	11
Remote Controller Operation.....	12
Deluxe Controller.....	13,14,15,16,17
Controllers Set Pattern/Temperature Tables.....	18
Error Messages	19,20
Maintenance & Service Information	21,22
Trouble Shooting and Common Questions	23
For Your Safety Read Before Operating	23
Operating Instructions.....	24
Care & Lime Condition Warning	24
Installer's Instructions	25-50

OWNER'S INSTALLATION INFORMATION

All Rinnai water heater(s) MUST be installed by a state qualified or licensed contractor. Failure to comply with state and local codes pertaining to water heater installations may void the warranty on your new water heater(s). It is the responsibility of the person having the water heater installed to ensure the installing contractor has proper licences and permits for installing water heater(s) in your location. In addition to licensing and permits, Rinnai encourages all installing contractors to attend a product knowledge class before installing any of our water heaters to help insure maximum customer satisfaction and maximum warranty coverage. Failure to comply with state and local codes may result in non-compliance and may void the warranty of the water heater(s).

This appliance must be installed in accordance with local codes, or in the absence of local codes, the National Fuel Gas Code, ANSI Z223.1/NFPA 54 and/or the CSA B149.1, Natural Gas and Propane Installation Code.

Install this product indoors ONLY, DO NOT install outdoors.

Do Not use this appliance if any part has been underwater. Immediately call a qualified service technician to inspect the appliance and to replace any part of the control system and any gas control which has been underwater.

Detailed instructions on the proper installation practices to follow for the installation of your new hot water heater(s) are included at the back of this manual.

FEATURES OF YOUR NEW WATER HEATER

- ☞ The Rinnai Water Heater is one of the most advanced water heaters available. It supplies hot water continuously at the temperature preset in the unit or at the temperature set on the optional remote controller(s). Installation of remote controller(s) are recommended for optimum performance.
- ☞ The Rinnai Water Heater never runs out of hot water. While electricity, water and gas supplies are connected, the Rinnai Water Heater produces hot water whenever the hot tap is open.
- ☞ The gas burner lights automatically when the hot water tap is opened, and goes out when the tap is closed. Ignition is electronic, there is no pilot light. When the hot water tap is off, no gas is used. You save energy and money with the Rinnai Water Heater.
- ☞ The temperature of the outgoing hot water is constantly monitored by a built in sensor. If the temperature of the outgoing water rises to more than 6 degrees above the selected temperature (shown on the digital remote control) the gas burner will automatically go out. The gas burner will re-ignite once the outgoing hot water temperature falls below the selected temperature.
- ☞ Built into the microprocessor of the Rinnai Water Heater is the ability to LIMIT THE MAXIMUM TEMPERATURE of the hot water supplied by the Rinnai Water Heaters. Without the connection of a remote controller(s), the Rinnai Water Heater is preset to deliver water at 120°F (Residential) and 140°F (Commercial).
- ☞ Residential Unit: With the remote controller(s) the water temperature is adjustable from 98 to 140°F. **The water temperature cannot be set to a temperature other than 120°F without the use of a remote controller unit.**
- ☞ Commercial Unit: With the remote controller the water temperature is adjustable up to 185°F. **The water temperature cannot be set to a temperature other than 140°F without the use of a remote controller unit.**
- ☞ Error messages are displayed on the optional remote controller(s), simplifying service calls.
- ☞ The Rinnai Water Heater incorporates a device to minimize temperature fluctuations (cold water sandwich effect) when the water is off, then on again. This effect can be eliminated by installing the Rinnai Water Heaters with a circulation loop with a small storage tank.
- ☞ The sound (noise) level from the Rinnai Water Heaters is very low.
- ☞ The Rinnai Water Heater is a very compact direct vented device. It saves valuable floor and wall space.

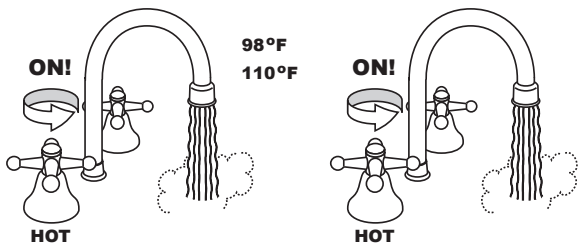
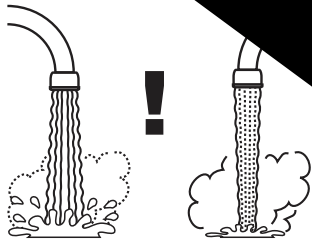

BASIC OPERATION

1 Adjusting Temperature

The outlet water temperature of the Rinnai Water Heater can only be adjusted by the user using the remote controller(s). To adjust the setpoint temperature of the Rinnai Water Heater, all hot water taps must be closed, and all circulating pumps turned off (where applicable). The temperature displayed on this remote controller will also be displayed on all other remote controller(s).

NOTE: TEMPERATURE CANNOT BE ADJUSTED EXCEPT BETWEEN 98°F AND 110°F WHEN ANY HOT WATER TAP IS OPEN.

2 To take control of the Rinnai Water Heater all hot water taps must be closed. Press the "Priority button" on the Controller you want to set the temperature with, and the green "Priority" indicator light will

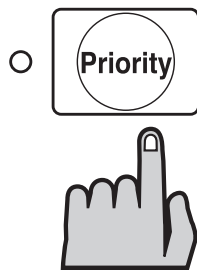

glow. This indicates that the Rinnai Water Heater is ready to supply hot water at the set temperature as soon as a tap is opened.

Note: Rinnai Water Heater will not provide hot water instantly at the hot water fixtures. Any cold water existing in the hot water lines must be purged first.

WARNING CHECK WATER TEMPERATURE BEFORE ENTERING SHOWER OR BATH.

3 Simply press the ▲ or ▼ button until the required temperature is displayed on the Digital Monitor.

WARNING There is a hot water scald potential if the thermostat is set to high.

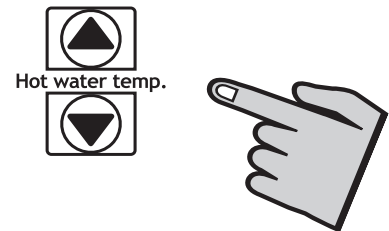

NOTE: CHECK LOCAL CODES FOR THE MAXIMUM WATER TEMPERATURE SETTING ALLOWED WHEN USED IN NURSING HOMES, SCHOOL, DAY CARE CENTERS, AND ALL OTHER PUBLIC APPLICATIONS.

4

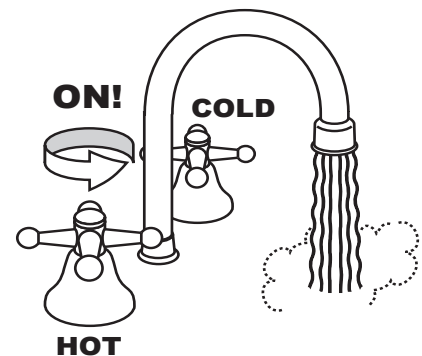

To operate the Rinnai Water Heater simply turn any hot water tap on. This will automatically light the burner providing hot water at the preset temperature. If the optional remote controller(s) have been installed, the red "IN USE" indicator will glow on all remote controller(s).

NOTE: If a newly installed unit has not been powered for at least six hours then the temperature will return to the default setting if power is interrupted.

ABOUT HOT WATER

Hot Water Is Dangerous, especially for the young and the elderly or the infirm. The Rinnai Water Heater allows you to precisely control the temperature of your hot water, ensuring safe hot water temperatures.

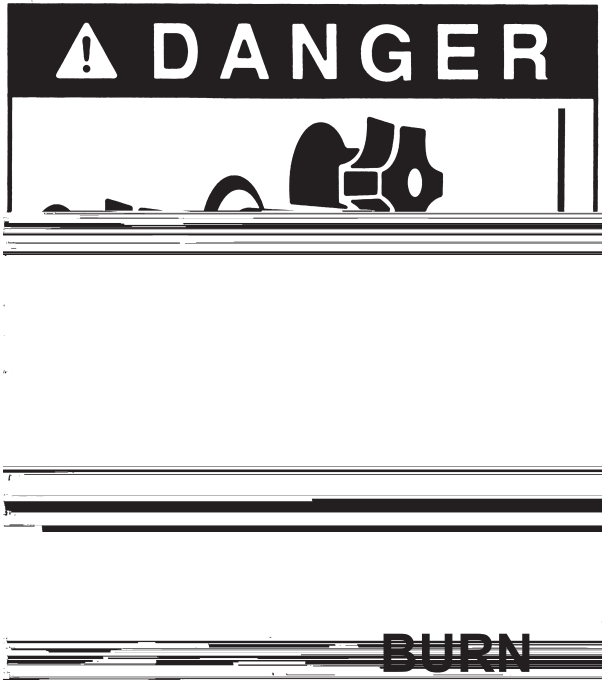

Water Temperatures over 125°F can cause severe burns instantly or death from scalds.

Hot Water can cause first degree burns with exposure for as little as:

- 3 seconds at 140 °F
- 20 seconds at 130 °F
- 8 minutes at 120 °F

Test the temperature of the water with your elbow before placing a child in the bath or shower.

Do not leave a child or an infirm person in the bath unsupervised.

Scalds - First Aid

- 1) **Remove clothing;** Remove all wet clothing, quickly. Wet clothing retains the heat.
- 2) **Apply cold water for 30 minutes;** Immediately submerge the burnt area in cold water for 30 minutes to reduce the heat in the skin, preventing deeper burning. Never use butter, oils or ointment to cover the burn. They may retain the heat.
- 3) **Keep the scalded person warm;** Place a blanket around the person.
- 4) **Seek Medical Advice;** Call your medical advice hotline and describe the scald, follow their directions.

GENERAL CONTROLLER INFORMATION

REMOTE CONTROLLERS IDENTIFICATION

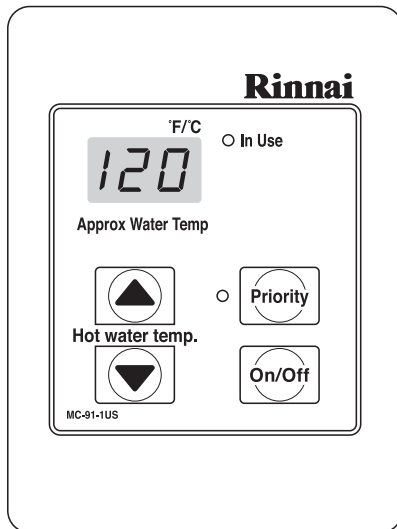

MC-91-1US (comes with the unit)



MC-100V-1US (optional)

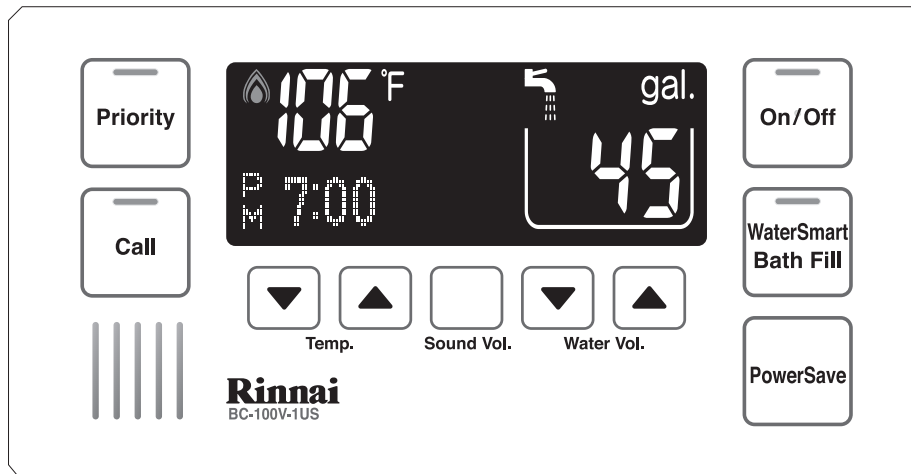



BC-100V-1US (optional)

The controller(s) for the Rinnai Water Heater allow the customer to control the functions of the water heater and to diagnose certain fault conditions

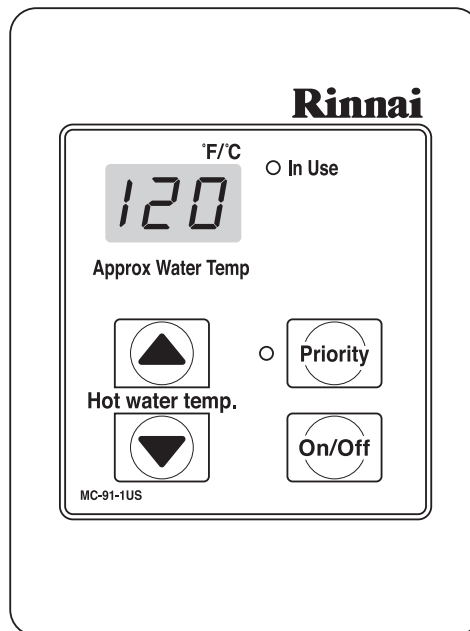
R E M O T E C O N T R O L L E R O P E R A T I O N



DIAGNOSTIC USE OF CONTROLLER

1. **To Display Maintenance Codes:** Press 'On/Off' button. To sequence through stored maintenance codes, press 'On/Off' followed by the  thermostat button.
2. **To Display Water Flow through water heater:** Press  thermostat button, hold for 2 seconds and simultaneously press 'On/Off' button.
3. **To display Outlet Water Temperature:** Press 

DELUXE CONTROLLER

ABOUT THE DELUXE CONTROLLER (MC-100V-1US)

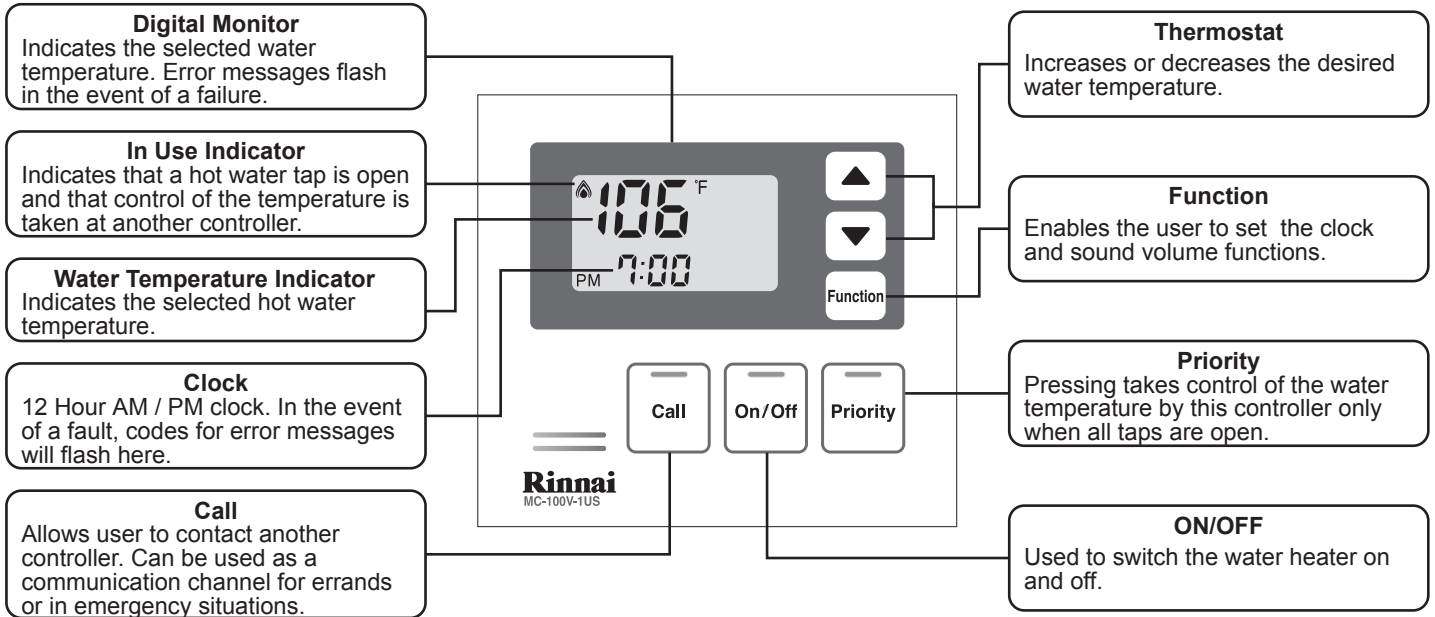

NOTE: With power interruption, water heater will automatically default to the ON position to provide hot water.

DELUXE BATHROOM CONTROLLER

ABOUT THE THE DELUXE BATHROOM CONTROLLER (BC-100V-1US)

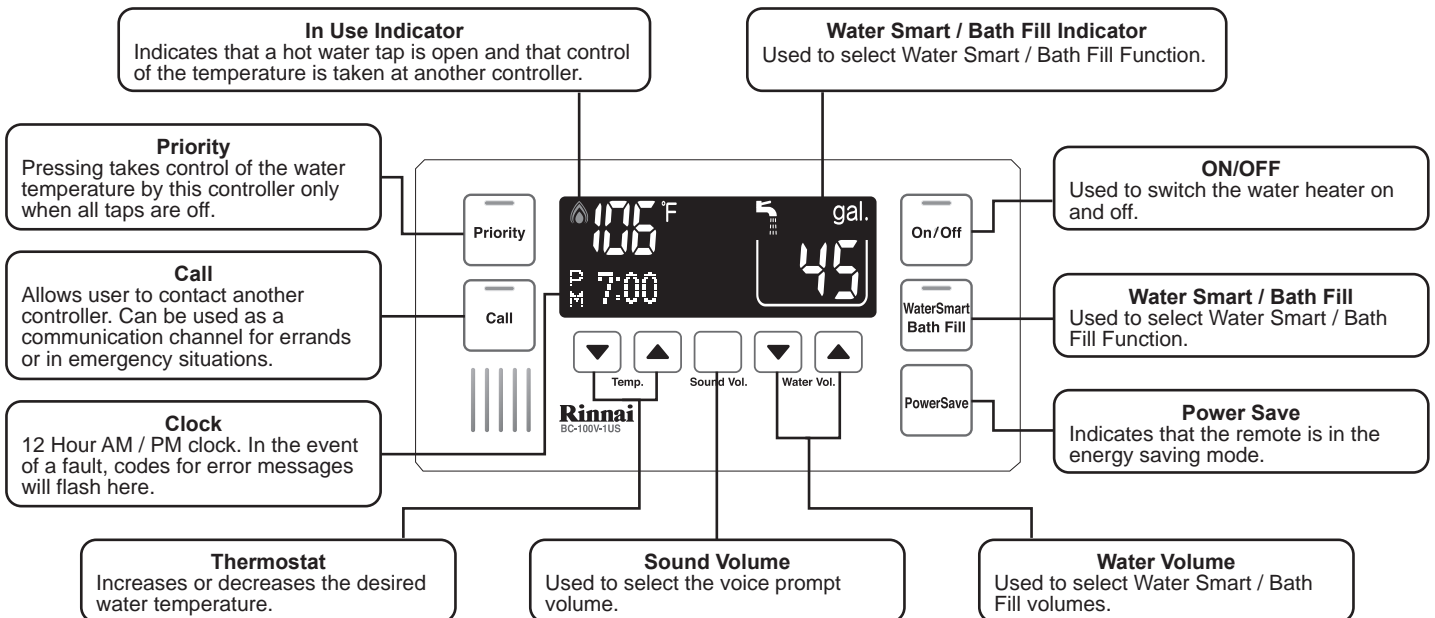

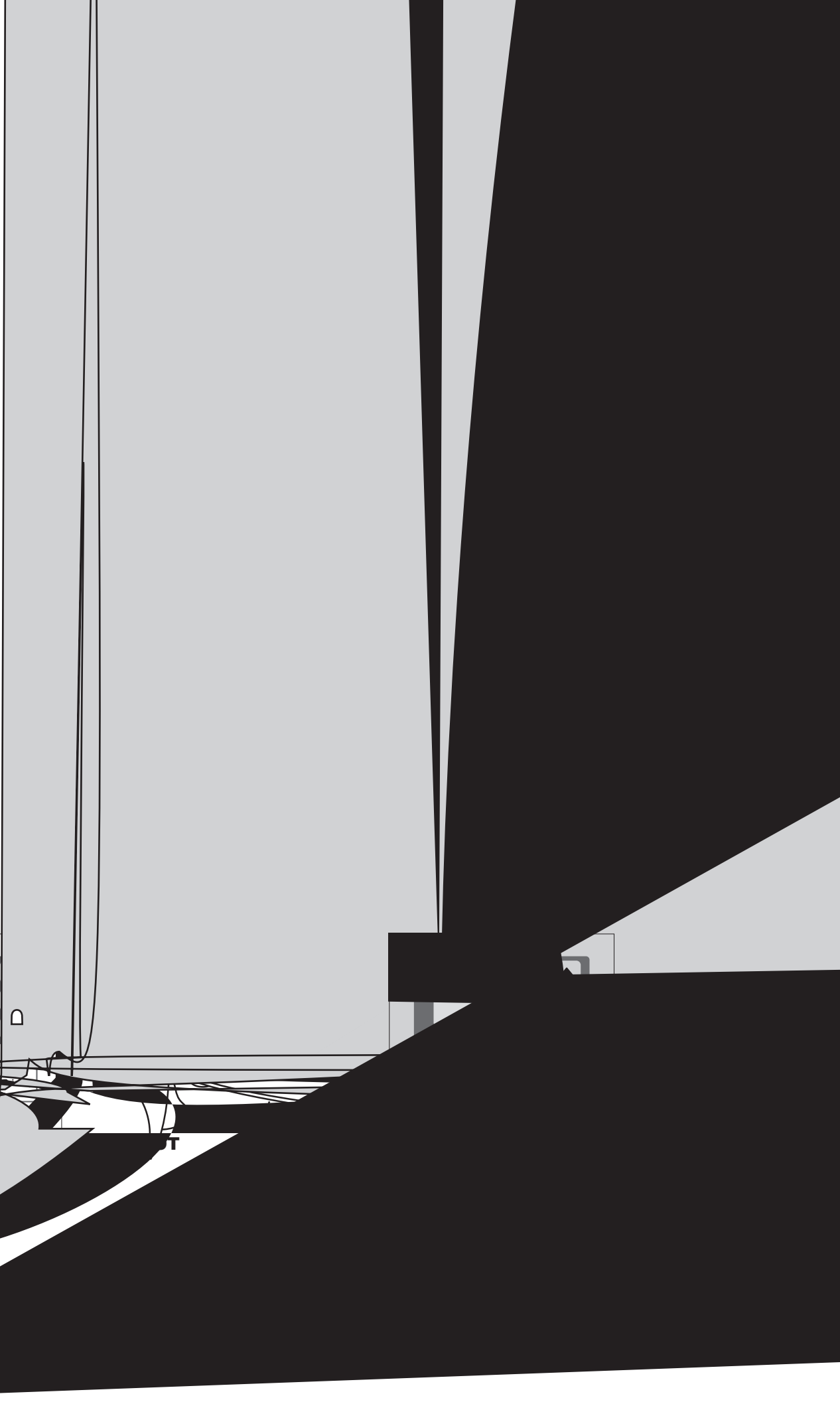
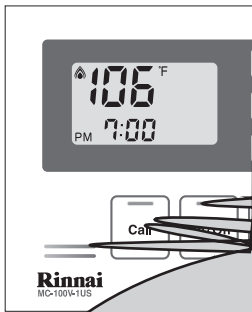

DELUXE BATHROOM CONTROLLER

Setting the Sound Volume

The voice prompt sound volume for all Deluxe Controller(s) can be set individually. To do this, press the 'Sound Vol.' button. The default voice prompt sound volume is medium, each subsequent press of the 'Sound Vol.' will cycle through the available volume settings in the following order: High Voice - Off Voice (beep) - Off Sound (no beep) - Low Voice - Medium Voice.

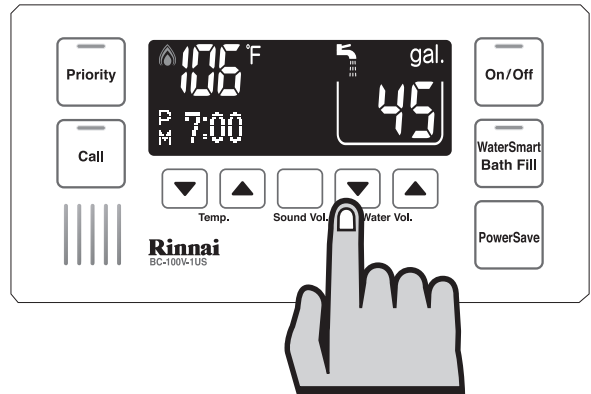

Adjusting Temperature

Simply press the 'Hot water temp.' ▲ or ▼ buttons until the required temperature is displayed on the Digital Monitor.

To Operate the hot water unit, open any hot water tap. This will automatically light the burner providing hot water. The red flame of the water heater 'In Use Indicator' 🔥 will illuminate on the Temperature Controller.

Once the hot water is running, if the set temperature is either too hot or cold, press the 'hot water temp.' ▲ or ▼ buttons until the desired temperature is reached.

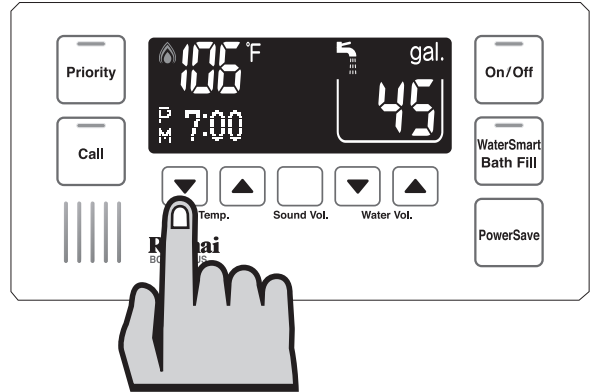

NOTE: TEMPERATURE CANNOT BE ADJUSTED EXCEPT BETWEEN 98°F AND 110°F WHEN ANY HOT WATER TAP IS OPEN.

⚠ WARNING CHECK WATER TEMPERATURE BEFORE USE.
A parent should always check the temperature before a child is placed in contact with hot water.

NOTE: Avoid getting water in the speaker as this may cause damage.

—

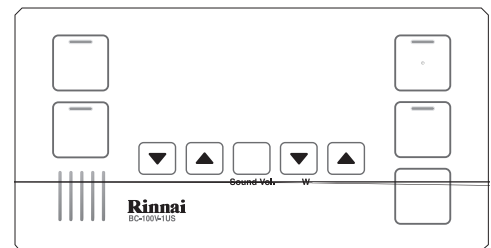
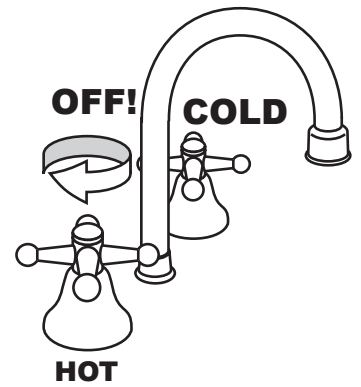
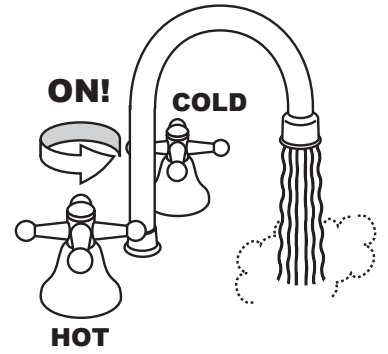

CONTROLLERS SET PATTERN/TEMPERATURE TABLES

Temperature controllers allows precise temperature control by the user. When used correctly, the hot water unit will deliver the selected temperature, even when the water flow is varied, or more than one tap is in use. Each Temperature Controller can be individually programmed, however the water heater unit can only deliver one set temperature at any time. The available temperatures (°F) are as follows:

Temperature Table by Models

model	temperature															
REU-V2532FFU / REU-V2532FFUD (°F) REU-V2520FFU / REU-V2520FFUD	98	100	102	104	106	108	110	115	120	125	130	135	140	—	—	—
REU-V2520FFUC / REU-V2520FFUCD (°F)	—	—	—	—	—	—	—	—	120	125	130	135	140	150	160	185
REU-V2532FFUC / REU-V2532FFUCD (°F)	98	100	102	104	106	108	110	115	120	125	130	135	140	150	160	185
Approx. temperature (°C)	37	38	39	40	41	42	43	46	49	52	54	57	60	66	71	85

Suggested temperatures are:

Kitchen 120°F, Shower 98°F - 110°F, Bath fill 102°F - 114°F

These temperatures are suggestions only. You may find higher or lower temperatures more comfortable. Maintaining lower temperatures helps save energy. To obtain water temperatures lower than 98°F, simply add cold water.

Deluxe Controllers are an optional extra. 'Controller' and 'Deluxe' Controllers can be installed together. Controllers allow temperature selection only. 'Deluxe' Controllers have temperature selection, bath fill and clock functions.

Controllers allow the water temperature to be set from the various locations where they are installed. The temperature selected will be available to all outlets. Below are the combination of Controllers that are offered by Rinnai:

Controllers Combination Pattern

Remote and Deluxe Controllers							
1	MC-91-1US	+	—	+	—	+	—
2	MC-91-1US	+	MC-91-1US	+	—	+	—
3	MC-91-1US	+	MC-91-1US	+	MC-91-1US	+	—
4	MC-91-1US	+	MC-91-1US	+	MC-91-1US	+	**MC-91-1US
5	MC-91-1US	+	BC-100V	+	MC-100V	+	—
6	MC-91-1US	+	MC-91-1US	+	BC-100V	+	MC-100V

****See controller manual in controller carton box for more information detail.**

Water Smart / Bath Fill Temperature Table

	temperature											
water smart/ bath fill temperature (°F)	98	100	102	104	106	108	110	112	114	116	118	120
Approx. temperature (°C)	37	38	39	40	41	42	43	44	46	47	48	49

Water Smart / Bath Fill temperature cannot exceed 120 °F for the following commercial models with no by-pass: REU-V2520FFUC REU-V2520FFUCD.

ERROR MESSAGES

The Rinnai Water Heater has the ability to check its own operation continuously. If a fault occurs, an Error Message will flash on the Digital Display of the Remote Controller. This assists with diagnosing the fault, and may enable you to overcome a problem without a service call. Please identify the code displayed when inquiring about service.

⚠ WARNING

Failure to remedy faults may result in severe burns, scalds, and/or death.

Error	Faulty	Remedy
02	No burner operation during freeze protection mode	Service Call
03	Power interruption during Bath fill (Water will not flow when power returns).	Turn off all hot water taps. Press ON/OFF twice.
10	Air Supply or Exhaust Blockage	Ensure Rinnai approved venting materials are being used. Check that nothing is blocking the flue inlet or exhaust. Check all vent components for proper connections. Ensure vent length is within limits. Ensure condensation collar was installed correctly. Verify dip switches are set properly. Check fan for blockage.
11	No Ignition	Check that the gas is turned on at the water heater, gas meter, or cylinder. Ensure gas type and pressure is correct. Ensure gas line, meter, and/or regulator is sized properly. Bleed all air from gas lines. Verify dip switches are set properly. Ensure appliance is properly grounded. Disconnect all MSA controls. Ensure igniter is operational. Check igniter wiring harness for damage. Check gas solenoid valves for open or short circuits. Remove burner cover and ensure all burners are properly seated. Remove burner plate and inspect burner surface for condensation or debris.
12	Flame Failure	Check that the gas is turned on at the water heater and gas meter. Check for obstructions in the flue outlet. Ensure gas line, meter, and/or regulator is sized properly. Ensure gas type and pressure is correct. Bleed all air from gas lines. Ensure proper Rinnai venting material was installed. Ensure condensation collar was installed properly. Ensure vent length is within limits. Verify dip switches are set properly. Ensure appliance is properly grounded. Disconnect keypad. Disconnect all MSA controls if installed. Check power supply for loose connections. Check power supply for proper voltage and voltage drops. Ensure flame rod wire is connected. Check flame rod for carbon build-up. Disconnect and re-connect all wiring harnesses on unit and PC board. Check all components for electrical short. Check gas solenoid valves for open or short circuits. Remove burner plate and inspect burner surface for condensation or debris.

ERROR MESSAGES

Error	Faulty	Remedy
14	Thermal Fuse	<p>Check gas type of unit and ensure it matches gas type being used.</p> <p>Check for restrictions in air flow around unit and vent terminal.</p> <p>Check for low water flow in a circulating system causing short-cycling.</p> <p>Ensure dip switches are set to the proper position.</p> <p>Check for foreign materials in combustion chamber and/or exhaust piping.</p> <p>Check heat exchanger for cracks and/or separations.</p> <p>Check heat exchanger surface for hot spots which indicate blockage due to scale build up. Refer to instructions in manual for flushing heat exchanger.</p> <p>Measure resistance of safety circuit.</p> <p>Ensure high fire and low fire manifold pressure is correct.</p> <p>Check for improper conversion of product.</p>
16	Over Temperature Warning	<p>Check for restrictions in air flow around unit and vent terminal.</p> <p>Check for low water flow in a circulating system causing short-cycling.</p> <p>Check for foreign materials in combustion chamber and/or exhaust piping.</p> <p>Check for clogged heat exchanger.</p>
32	Outgoing Water Temperature Sensor Fault	<p>Check sensor wiring for damage.</p> <p>Measure resistance of sensor.</p> <p>Clean sensor of scale build up.</p> <p>Replace sensor.</p>
33	Heat Exchanger Outgoing Temperature Sensor Fault	<p>Check sensor wiring for damage.</p> <p>Measure resistance of sensor.</p> <p>Clean sensor of scale build up.</p> <p>Replace sensor.</p>
34	Combustion Air Temperature Sensor Fault	<p>Check for restrictions in air flow around unit and vent terminal.</p> <p>Check sensor wiring for damage.</p> <p>Measure resistance of sensor.</p> <p>Clean sensor of scale build up.</p> <p>Ensure fan blade is tight on motor shaft and is in good condition.</p> <p>Replace sensor.</p>
52	Modulating Solenoid Valve Signal Abnormal	<p>Check modulating gas solenoid valve wiring harness for loose or damage terminals.</p> <p>Measure resistance of valve coil.</p>
61	Combustion Fan Failure	<p>Ensure fan will turn freely.</p> <p>Check wiring harness to motor for damaged and/or loose connections.</p> <p>Measure resistance of motor winding.</p>
65	Water Flow Servo Faulty (Does not stop flow properly)	<p>Water Flow Servo or wiring faulty. Check Water Flow Servo wiring harness connection.</p> <p>Measure resistance of Water Flow Servo wiring.</p> <p>If blank screen is present on remote control then the Water Flow Servo has shorted out. Unplug Water Flow Servo. If remote lights up and unit starts operating then replace Water Flow Servo.</p>
71	SV0, SV1, SV2, and SV3 Solenoid Valve Circuit Fault	<p>Check wiring harness to all solenoids for damage and/or loose connections.</p> <p>Measure resistance of each solenoid valve coil.</p>
72	Flame Sensing Device Fault	<p>Ensure flame rod is touching flame when unit fires.</p> <p>Check all wiring to flame rod for damage.</p> <p>Remove flame rod and check for carbon build-up; clean with sand paper.</p> <p>Check inside burner chamber for any foreign material blocking flame at flame rod.</p> <p>Measure micro amp output of sensor circuit with flame present.</p> <p>Replace flame rod.</p>
LC (00)	Scale Build-up in Heat Exchanger (when checking maintenance code history "00" is substituted for "LC")	<p>Flush heat exchanger. Refer to instructions in manual.</p> <p>Replace heat exchanger.</p>
No code	Nothing happens when water flow is activated.	<p>Clean inlet water supply filter.</p> <p>On new installations ensure hot and cold water lines are not reversed.</p> <p>Check for bleed over. Isolate unit from building by turning off hot water line to building. Isolate the circulating system if present. Open your pressure relief valve; if unit fires, there is bleed over in your plumbing.</p> <p>Ensure you have at least the minimum flow rate required to fire unit.</p> <p>Ensure turbine spins freely.</p> <p>Measure the resistance of the water flow control sensor.</p> <p>Remote control does not light up but you have 12 VDC at the terminals for controls.</p>

MAINTENANCE & SERVICE INFORMATION

⚠ WARNING

Always turn off the electrical power supply, the manual gas valve and the manual water control valve whenever servicing the unit.



The Rinnai Water Heater should be checked by a Properly Trained Technician once a year. A Properly Trained Rinnai Technician should perform any repairs that may be necessary.

The following items should be checked each inspection:

- 1) The area around the Rinnai unit should be free from combustible materials such as cloth, vegetation and building materials. (see page 8)
- 2) Check burners for presence of foreign debris, insects or bugs. These items are not covered by the unit's warranty.
- 3) Remove and clean the inlet water filter.
- 4) Keep the appliance area clear and free from combustible materials, gasoline, and other flammable vapors and liquids.
- 5) Do not obstruct flow of combustion and ventilation air.

In the case of any fault or error message from the Rinnai Water Heater, first turn all hot water taps off. Wait for 5 seconds. Turn the hot water tap back on. If the error message still remains, call your Rinnai Authorized Service Representative or Rinnai at 800-621-9419.

Should overheating occur or the gas supply fail to shutoff, turn off the manual gas control valve to the appliance.



DO NOT ATTEMPT TO SERVICE YOUR Rinnai YOURSELF.

Call a Rinnai Authorized Service Technician or call your installer.

MAINTENANCE & SERVICE INFORMATION

MAINTENANCE SUGGESTIONS

This water heater has been designed and constructed for a long performance life when installed and operated properly under normal conditions. Regular inspections, as outlined in this section, are strongly recommended as a means of keeping your heater operating efficiently.

Consideration should be given to periodic maintenance of scale removal in applications where the water hardness quality is elevated and the water heater runs for extended periods such as in commercial applications or applications with circulating loops.

1. Cleaning

The water heater should be cleaned annually.

Keep the water heater clear of dust and debris especially in and around burner.

Cleaning procedures for the Rinnai Water Heater are as follows:

- 1) Turn off and disconnect electrical power. Allow to cool for one hour.
- 2) Remove the Front Panel by removing screws. See parts breakdown on panels.
- 3) Use pressurized air to remove dust from around main burner.
- 4) Use soft dry cloth to wipe cabinet.

DO NOT DAMAGE OR DISTORT ANY PARTS OF HEATER.

DO NOT USE WET CLOTH OR SPRAY CLEANERS ON BURNER.

2. Visual check of main burner flames.

The burner must flame evenly over the entire surface when operating correctly. The flame must burn with a clear, blue, stable flame. See the parts breakdown of the burner for the location of view ports. Any and all parts removed for inspection or service must be replaced before operating the unit.

The flame pattern should be as shown in the following Figures.

VISUAL CHECK

SATISFACTORY

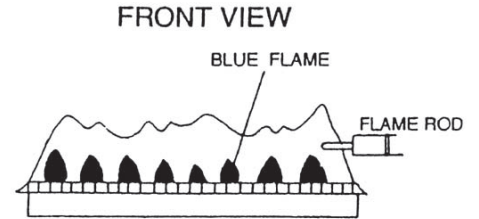

UNSATISFACTORY

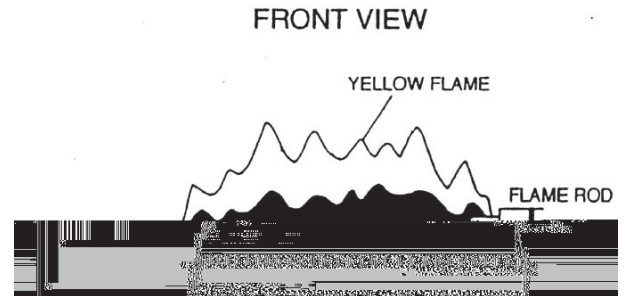

* VENT MAINTENANCE

* VENT SYSTEM

Must be checked annually for blockage or deterioration. See vent installation instructions.

* MAINTENANCE-ELECTRIC MOTORS

Motors are permanently lubricated and need no lubrication. Keep fan and motor free of dust and dirt, clean annually.

TROUBLE SHOOTING AND COMMON QUESTIONS

Q - *I don't have any hot water when I open the tap!*

A - Make sure there is gas, water and electricity to the Rinnai Water Heater (the power is turned on and the gas is turned on)

Q - *When I was using the hot water, the water got cold!*

A - If you adjusted the flow from the tap to lessen it, you may have gone below the minimum flow required. The Rinnai Water Heater requires a minimum flow rate to operate (see specification page for flow rate of your unit). If you mix the water with a tap and attempt to get a temperature well below the temperature being controlled by the unit, it may drop the flow below the desired minimum flow rate. Decrease the temperature supplied by the Rinnai Water Heater at the remote control or increase your total flow.

Q - *White smoke comes out of the exhaust!*

A - During colder weather when the exhaust temperature is hotter than the air, the exhaust fumes condense producing white steam.

Q - *When I open a hot tap. I do not immediately get hot water!*

A - Hot water must travel through your plumbing from the Rinnai Water Heater to the faucet. The time period for hot water to reach your fixture is determined by the amount of water in your plumbing system between your water heater and the fixture, water pressure, flow rate of fixture in use, etc.

Q - *After I turn off the hot water tap, the fan on the Rinnai Water Heaters continues to run!*

A - The fan is designed to be on for 65 seconds after the flow of water stops. This is to ensure constant water temperatures during rapid starting and stopping, as well as exhausting any residual gas flue products from the unit.

FOR YOUR SAFETY READ BEFORE OPERATING

⚠ WARNING If you do not follow these instructions exactly, a fire or explosion may result causing property damage, personal injury or loss of life.

- A. This appliance does not have a pilot. It is equipped with a direct ignition device which automatically lights the burner. Do not try to light the burner by hand.
- B. BEFORE OPERATING: Smell all around the appliance area for gas. Be sure to smell next to the floor because some gas is heavier than air and will settle on the floor.

WHAT TO DO IF YOU SMELL GAS

- Do not try to light any appliance.
- Do not touch any electric switch, do not use any phone in your building.
- Immediately call your gas supplier from a

neighbor's phone. Follow the gas supplier's instructions.

- If you cannot reach your gas supplier, call the fire department.
- C. Use only your hand to operate remote control keypad. Never use tools. If the remote keypad doesn't work, do not try to repair it, call a qualified service technician. Force or attempted repair may result in a fire or explosion.
- D. Do not use this appliance if any part has been under water. Immediately call a qualified service technician to inspect the appliance and to replace any part of the control system and any gas control which has been under water.

O P E R A T I N G I N S T R U C T I O N S

- 1) STOP! Read the safety information above before proceeding.
- 2) Set the thermostat to lowest setting.
- 3) Turn off all electric power to the appliance.
- 4) This appliance does not have a pilot. It is equipped with a direct ignition device which automatically lights the burner. Do not try to light the burner by hand.
- 5) Turn the manual valve located at gas inlet of the appliance clockwise

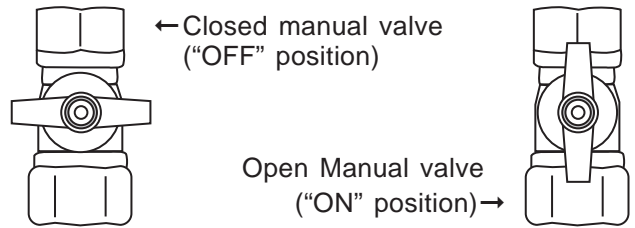

inlet of appliance counterclockwise ↺ to "ON".

- 8) Turn on all electric power to the appliance.
- 9) Set thermostat to desired setting.
- 10) If the appliance will not operate, Follow the instructions "To Turn Off Gas To Appliance" and call your service technician or gas supplier.

To Turn Off Gas To Appliance

- 1) Set the thermostat to lowest setting.
- 2) Turn off all electric power to the appliance if service is to be performed.
- 3) Turn the manual valve at gas inlet of appliance clockwise ↻ to "OFF"



Installer's Instructions

This section is for the Qualified Installer only. **If you are not properly trained, you should not install this unit.** The warranty may be voided due to installation by a non-qualified installer. For information on Rinnai Training Courses, call 1-800-621-9419.

Contents of Installer's Manual

Warnings.....	26,27
Locating the Vent Terminal.....	28
Performance Data.....	29
Dimensions	30
Recommended Piping for Installation.....	31,32,33,34
Venting.....	35,36
Freeze Protection	37
Gas Piping Sizing Chart.....	38
Gas Piping Notes	39
Water Piping Notes.....	40
Pressure Relief Valve	40
Lighting the Unit	41
Remote Controllers.....	42
Remote Controllers Installation	43,44
Testing	45
Schematic Diagram	46,47

Rinnai

www.rinnai.us
800-621-9419

INSTALLER'S INSTALLATION INSTRUCTIONS -Warnings- (Residential Unit)

This manual must be followed exactly.

- 1) Read the safety issues completely before installing the Rinnai Water Heater.
- 2) This water heater is suitable for residential water (potable) heating ONLY. DO NOT use this water heater for space heating, combination space heating/ domestic water heating, or commercial water heating applications.
- 3) The Rinnai Water Heater is not suitable for use in pool or spa applications.
- 4) This unit is designed to be installed indoors using the proper vent piping to exhaust by-products of combustion to the outside environment. Contact your dealer or Rinnai for proper vent kits. **DO NOT** operate this unit without vent piping connected. Exhaust gasses must be expelled outside the home.
- 5) Maintain proper space around the unit for proper servicing and operation. Minimum clearances from combustible materials are listed below.

Top of Heater	6 inches
Back of Heater	0 inch
Front of Heater	6 inches
Sides of Heater	2 inches
Floor	12 inches
Vent/Air Intake	0 inches

- 6) Installer must install a Pressure relief valve. Pipe pressure relief discharge to a drain or outside environment (See pressure relief valve section).
- 7) The appliance should be located in an area where leakage of the unit or connections will not result in damage to the area adjacent to the appliance or to lower floors of the structure. When such locations cannot be avoided, it is recommended that a suitable drain pan, adequately drained, be installed under the appliance. The pan must not restrict combustion air flow.

INSTALLER'S INSTALLATION INSTRUCTIONS -Warnings- (Commercial Unit)

This manual must be followed exactly.

- 1) Read the safety issues completely before installing the Rinnai Water Heater.
- 2) This water heater is suitable for water (potable) heating or space heating.
 - The piping and components connected to the Rinnai Water Heater must be approved for use in potable water systems.
 - Toxic chemicals such as those used for boiler water treatment are NOT to be introduced to the potable water used for space heating.
 - The Rinnai Water Heater, if it will be used as a potable water source, must not be connected to a system that was previously used with a nonpotable water heating appliance.
 - When the system requires water for space heating at temperatures higher than required for other uses, a means such as mixing valve shall be installed to temper the water for other uses in order to reduce the scald hazard potential.
- 3) The Rinnai Water Heater is not suitable for use in pool or spa applications
- 4) This unit is designed to be installed indoors using the proper vent piping to exhaust by-products of combustion to the outside environment. Contact your dealer or Rinnai for proper vent kits. **DO NOT** operate this unit without vent piping connected. Exhaust gasses must be expelled outside the home.
- 5) Maintain proper space around the unit for proper servicing and operation.
Minimum clearances from combustible materials are listed below.

- 6) Installer must install a Pressure relief valve. Pipe pressure relief discharge to a drain or outside environment (See pressure relief valve section).

Top of Heater	6	inches
Back of Heater	0	inch
Front of Heater	6	inches
Sides of Heater	2	inches
Floor	12	inches
Vent/Air Intake	0	inches

- 7) The appliance should be located in an area where leakage of the unit or connections will not result in damage to the area adjacent to the appliance or to lower floors of the structure. When such locations cannot be avoided, it is recommended that a suitable drain pan, adequately drained, be installed under the appliance.

INSTALLER'S INSTALLATION INSTRUCTIONS

Locating the vent terminal

RECOMMENDED VENT/AIR INTAKE TERMINAL POSITION

Terminals should be so positioned as to avoid products of combustion entering openings into buildings or other flues or vents.

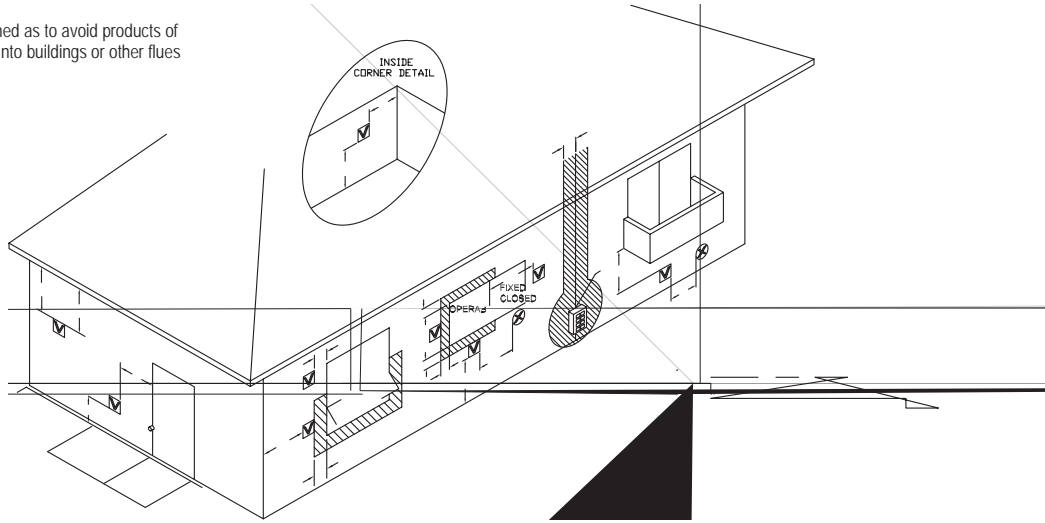

NOTE: Maintain 12" of clearance above the highest anticipated snow level or grade, or whichever is greater. Please refer to your local codes for the snow level in your area.

REF	DESCRIPTION	U.S. Installations	Canadian Installations
A	Clearance above grade, veranda, porch, deck, or balcony	1 foot	1 foot
B	Clearance to window or door that may be opened	1 foot	3 feet
C	Clearance to permanently closed window	*	*
D	Vertical clearance to ventilated soffit, eaves or overhang	*	*
E	Clearance to unventilated soffit, eaves or overhang	*	*
F	Clearance to outside corner	*	*
G	Clearance to inside corner	*	*
H	Clearance to each side of center line extended above meter/regulator assembly	*	3 feet within a height 15 feet above the meter/regulator assembly
I	Clearance to service regulator vent outlet	*	3 feet
J	Clearance to nonmechanical air supply inlet to building or the combustion air inlet to any other appliance	1 foot	3 feet
K	Clearance to a forced air inlet into a building	3 feet above if within 10 feet horizontally	6 feet
L	Clearance above paved sidewalk or paved driveway located on public property	*	7 feet
M	Clearance under deck, veranda, porch, or balcony (open on 3 sides)	*	1 foot

* For clearances not specified in ANSI Z223.1 / NFPA 54 or CAN/CGA-B149, use **clearances in accordance with local installation codes and the requirement of the gas supplier.**

NOTE: ONLY Rinnai Approved vent materials and components can be used to vent the water heaters. When installing your Rinnai vent system, you **MUST** follow Rinnai's Venting Instructions found in each vent terminal box. These instructions provide the maximum allowable vent heights for both horizontal and vertical venting, how to cut the vent components, and pipe installations.

NOTE: For high altitude installations contact Rinnai at 1-800-621-9419.

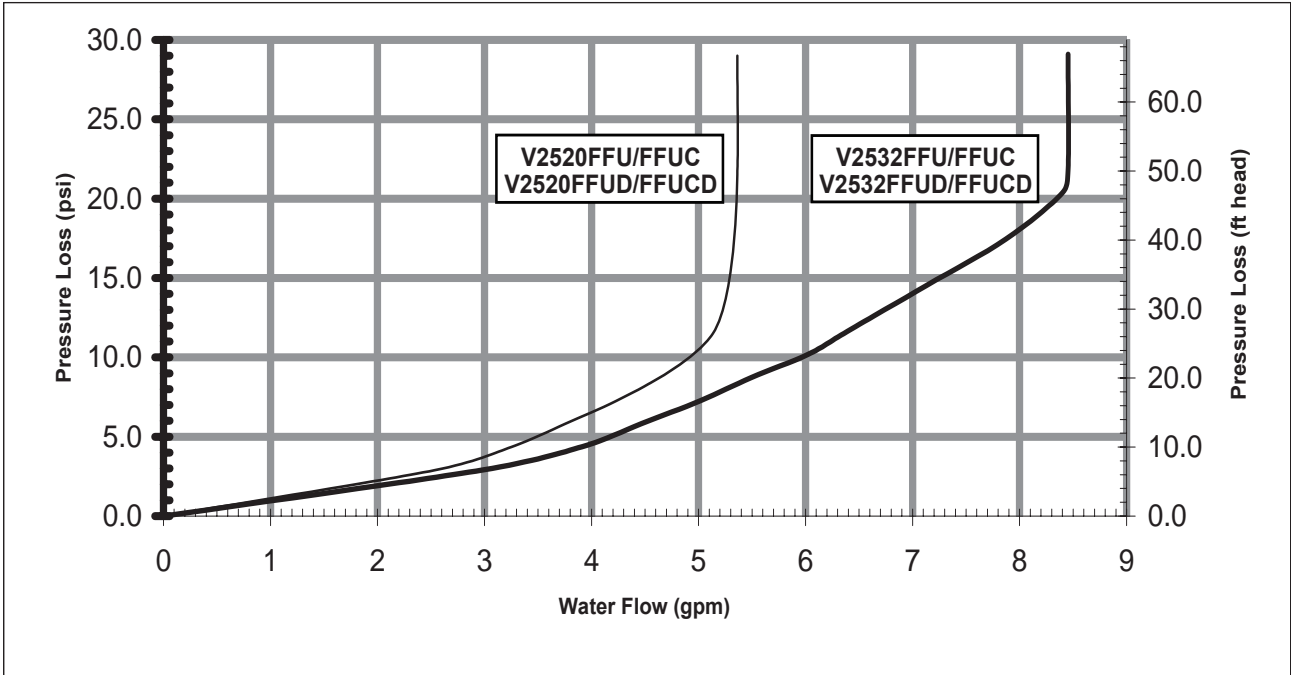

INSTALLER'S INSTALLATION INSTRUCTIONS

Dimensions

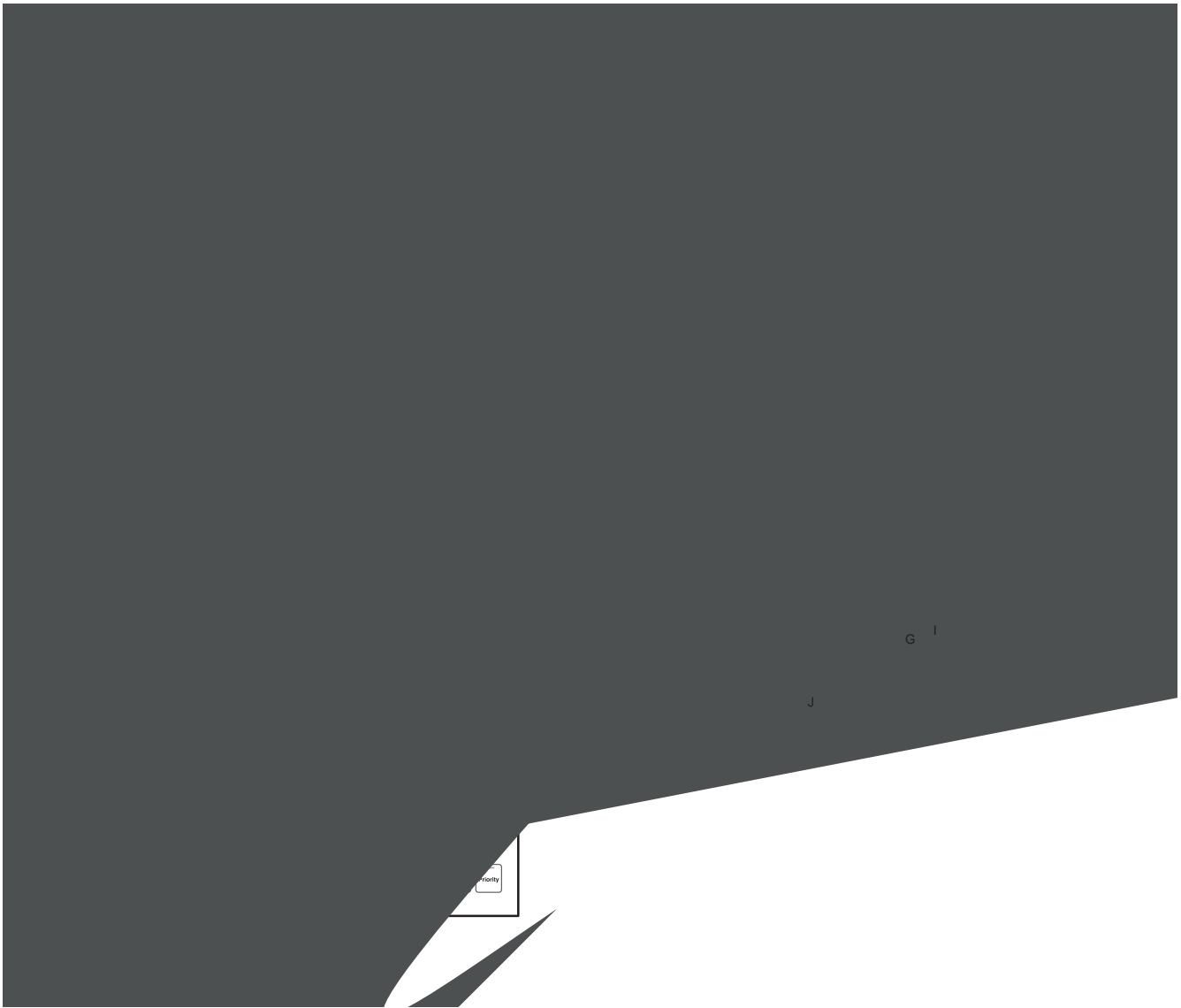

	2	E	25	U-V2532FFUD R U-V2532FFUD	REU-V2520FFUD REU-V2 20FFUD
				11.8"	14.0"
			9.2" - 10.8"		
					22.9"
					25.6"
					3.6" - 5.1"
			4.3"		4.3"
			2.8" - 4.3"		2.8" - 4.3"
					1"
I	Gas Connection (from wall)	J	Gas Connection (from ceiling)	3.9" - 5.5"	3.5"
	Gas: Length to Connection (from base)		1.6"		1.6"
	Cold: Length to Connection (from base)		2"		2"
	Hot: Length to Connection (from base)		1.6"		1.6"
	Gas: Fitting Diameter				3/4"NPT
	Cold: Fitting Diameter				3/4"NPT
	Hot: Fitting Diameter				3/4"NPT

**Rinnai
Water Heater**

Rinnai
Equipment List
**(Residential and
Commercial)**

Rinnai
Water Heaters
(Indoor)

MC-91 Controller
(Included)

MC-100V a

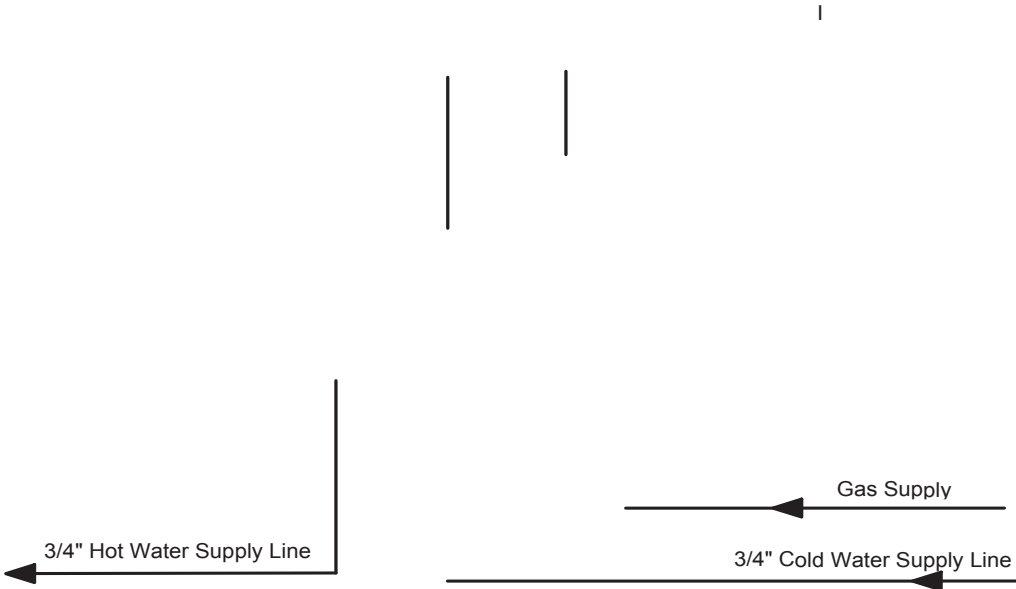

INSTALLER'S INSTALLATION INSTRUCTIONS

RECOMMENDED PIPING FOR CIRCULATION SYSTEMS

Notes:

PLEASE NOTE FOR RESIDENTIAL APPLICATIONS, THIS PIPING ARRANGEMENT MAINTAINS FULL WARRANTY:

**10 Years On Heat Exchanger
5 Years On Parts**

Commercial Application Warranty:

**5 Years On Heat Exchanger
5 Years On Parts**

**Venting Equipment List
(Commercial and Residential)**

Indoor Unit

Please Review Venting Instructions/Guidelines for Proper Components and Installation.

Important: Install building return line to the hot supply as close as possible to the Rinnai Water Heater.

Pump Should be Controlled by an Aquastat, Timer or Combination Aquastat and Timer. Pump to be sized for Pressure Drop through Building Supply and Return Piping. **Pump to be of Bronze or Stainless Construction.**

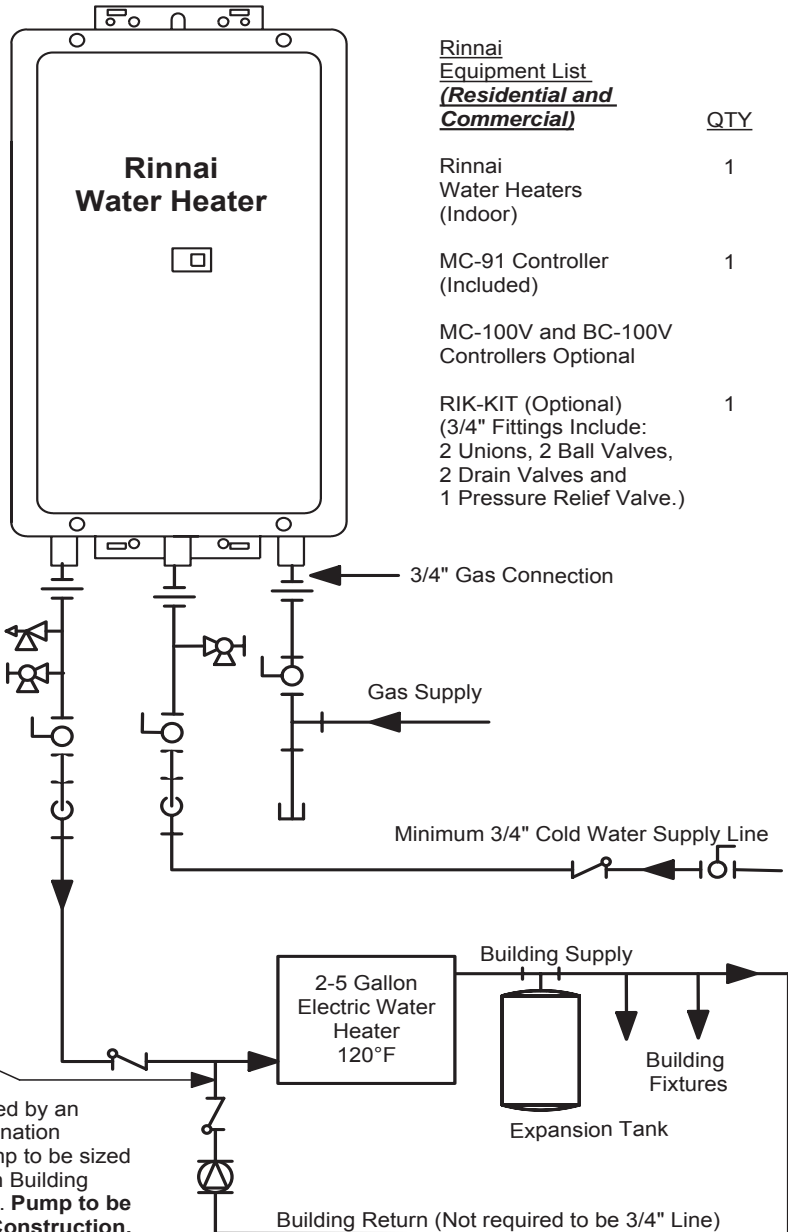

Rinnai Equipment List <u>(Residential and Commercial)</u>		QTY
Rinnai Water Heaters (Indoor)		1
MC-91 Controller (Included)		1
MC-100V and BC-100V Controllers Optional		
RIK-KIT (Optional) (3/4" Fittings Include: 2 Unions, 2 Ball Valves, 2 Drain Valves and 1 Pressure Relief Valve.)		1

KEY

	3/4" Ball Valve		Pressure Regulator
	3/4" Union		Circulating Pump
	Check Valve		Boiler Drain Valve
	Pressure Relief Valve		Solenoid Valve

This is not an engineered drawing, it is intended only as a guide and not as a replacement for professionally engineered project drawings. This drawing is not intended to describe a complete system, it is up to the contractor/engineer to determine the necessary components for and configuration of the particular system being installed. The drawing does not imply compliance with local building code requirements. It is the engineer/contractor responsibility to ensure the installation is in accordance with all local building codes. Confer with local building officials before installation.

Rinnai

103 International Drive
Peachtree City, Georgia 30269

RINNAI WATER HEATERS

Domestic Hot Water - Circulation Systems
1 Rinnai Water Heater with Electric Storage Tank

INSTALLER'S INSTALLATION INSTRUCTIONS

OPTIONAL PIPING FOR CIRCULATION SYSTEMS

Note:

PLEASE NOTE FOR RESIDENTIAL APPLICATIONS, THIS PIPING ARRANGEMENT REDUCES WARRANTY TO THE FOLLOWING:

**3 Years On Heat Exchanger
3 Years On Parts**

Commercial Application Warranty:

**5 Years On Heat Exchanger
5 Years On Parts**

Venting Equipment List (Residential and Commercial)

Indoor Unit

Please Review Venting Instructions/Guidelines for Proper Components and Installation.

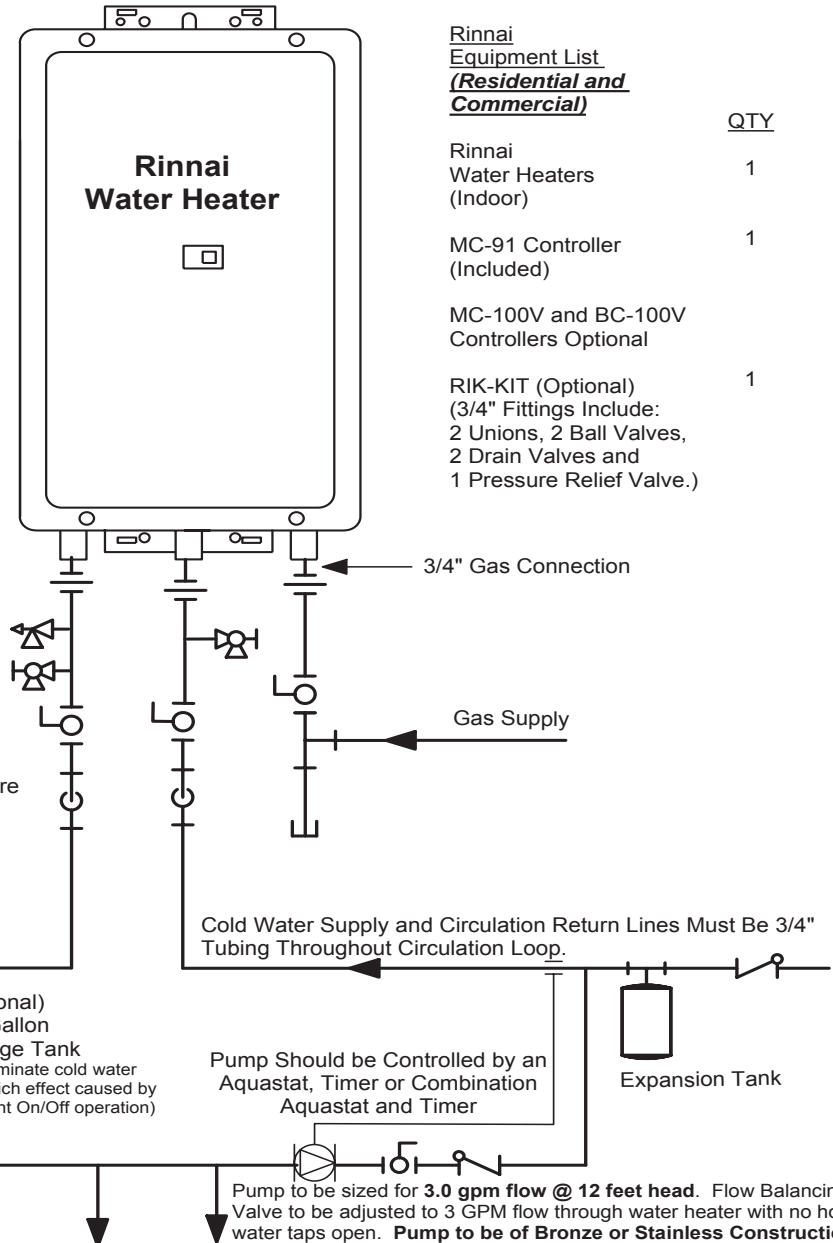

Rinnai Equipment List (Residential and Commercial)		QTY
Rinnai Water Heaters (Indoor)		1
MC-91 Controller (Included)		1
MC-100V and BC-100V Controllers Optional		
RIK-KIT (Optional) (3/4" Fittings Include: 2 Unions, 2 Ball Valves, 2 Drain Valves and 1 Pressure Relief Valve.)		1

Note:

Water heater outlet temperature cannot be adjusted when circulation pump is running.

Minimum 3/4" Hot Water Supply Line

(Optional) 2-6 Gallon Storage Tank (To eliminate cold water sandwich effect caused by frequent On/Off operation)

Cold Water Supply and Circulation Return Lines Must Be 3/4" Tubing Throughout Circulation Loop.

Pump Should be Controlled by an Aquastat, Timer or Combination Aquastat and Timer

Expansion Tank

Building Fixture Outlets

Pump to be sized for 3.0 gpm flow @ 12 feet head. Flow Balancing Valve to be adjusted to 3 GPM flow through water heater with no hot water taps open. **Pump to be of Bronze or Stainless Construction.**

KEY

	3/4" Ball Valve		Pressure Regulator
	3/4" Union		Circulating Pump
	Check Valve		Boiler Drain Valve
	Pressure Relief Valve		Solenoid Valve

This is not an engineered drawing, it is intended only as a guide and not as a replacement for professionally engineered project drawings. This drawing is not intended to describe a complete system, it is up to the contractor/engineer to determine the necessary components for and configuration of the particular system being installed. The drawing does not imply compliance with local building code requirements. It is the engineer/contractor responsibility to ensure the installation is in accordance with all local building codes. Confer with local building officials before installation.

Rinnai

103 International Drive
Peachtree City, Georgia 30269

RINNAI WATER HEATERS

Domestic Hot Water with Circulation
1 Rinnai Water Heater

INSTALLER'S INSTALLATION INSTRUCTIONS

RECOMMENDED SCALE FLUSH PROCEDURE

RINNAI Water Heater Flush Procedure

1. Disconnect power to the Rinnai Water Heaters.
2. Close valves V3 and V4.
3. Connect pump outlet hose H1 to service valve V2.
4. Connect drain hose H3 to valve V1.
5. Pour approximately 4 gallons of virgin, food grade, white vinegar (or virgin, food grade, citric acid) into pail.
6. Place free ends of hose H2 and H3 into pail.
7. Open valves V1 and V2.
8. Turn on power to circulating pump and allow solution to circulate through water heater for 45 minutes.
9. Turn off power to circulating pump.
10. Remove free end of hose H3 from pail.
11. Close valve V2 and open valve V4, only.
Do NOT open valve V3 at this time.
12. Allow water to flow out of hose H3 for 5 minutes, rinsing cleaning solution from water heater.
13. Close valve V1 and open valve V3.
14. Disconnect hoses H1 and H3 from service valves.
15. Remove in-line filter from water heater cold water inlet and clean out any residue. Place filter back into unit.
16. Restore power to water heater.

5 gallon pail of virgin, food grade, white vinegar (or virgin, food grade, citric acid).

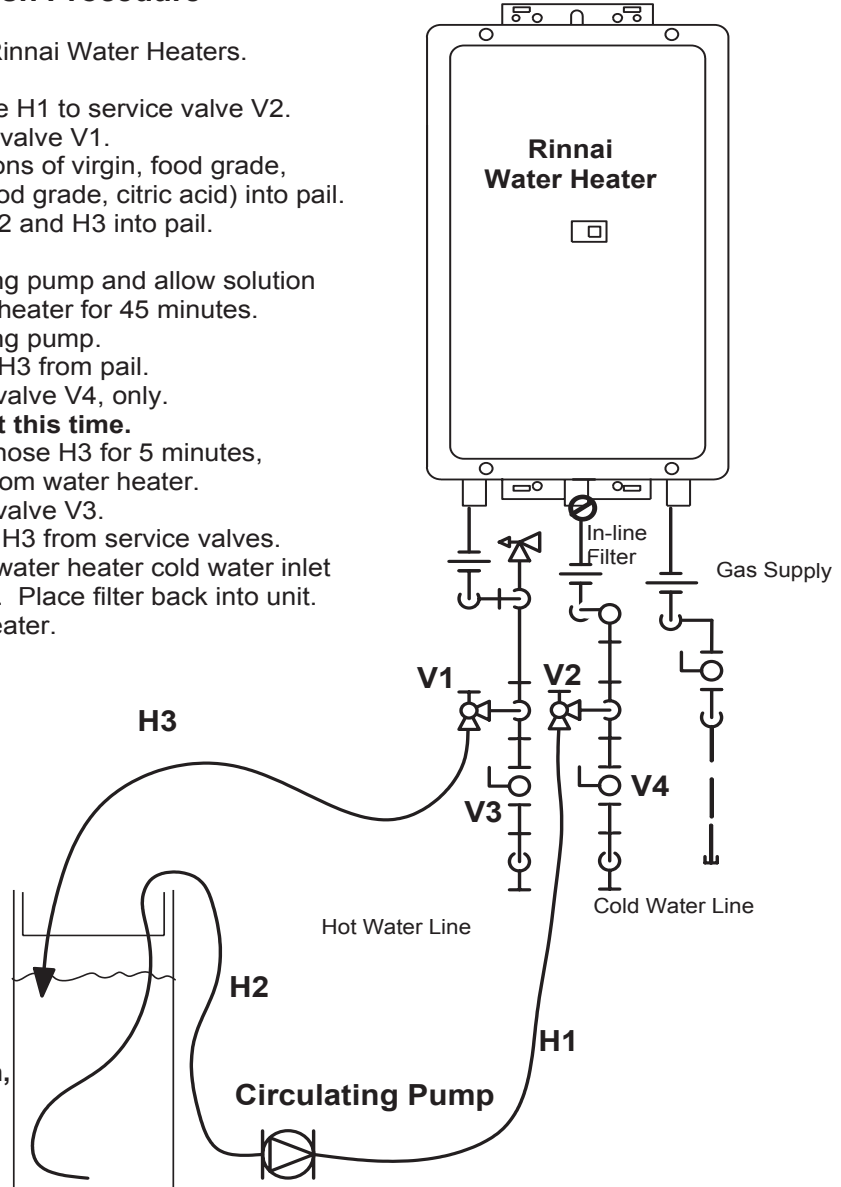

KEY

	3/4" Ball Valve		Pressure Regulator
	3/4" Union		Circulating Pump
	Check Valve		Boiler Drain Valve
	Pressure Relief Valve		Solenoid Valve

This is not an engineered drawing, it is intended only as a guide and not as a replacement for professionally engineered project drawings. This drawing is not intended to describe a complete system, it is up to the contractor/engineer to determine the necessary components for and configuration of the particular system being installed. The drawing does not imply compliance with local building code requirements. It is the engineer/contractor responsibility to ensure the installation is in accordance with all local building codes. Confer with local building officials before installation.

Rinnai

103 International Drive
Peachtree City, Georgia 30269

RINNAI WATER HEATERS

Domestic Hot Water - Scale Flush Procedure
1 Rinnai Water Heater

INSTALLER'S INSTALLATION INSTRUCTIONS

Venting

Condensate

Condensate formation can occur in Category III direct vent appliances.

- Vertical terminations must incorporate a condensate drain and trap as close as possible to the appliance.
- The condensate trap must contain a minimum of 3" of water.
- Dispose of condensate per local codes.
- Slope horizontal venting 1/4 inch per foot either towards the heater with a condensate collector or towards the exhaust terminal.

NOTE: Provisions must be made to prevent the condensate from entering the water heater. Without proper drainage or disposal condensate will damage the heat exchanger.

Horizontal Venting without a Condensate Collector

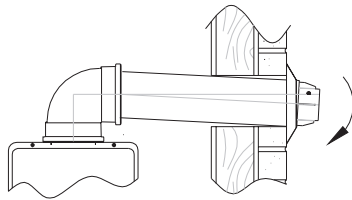

Maximum Height
5 feet

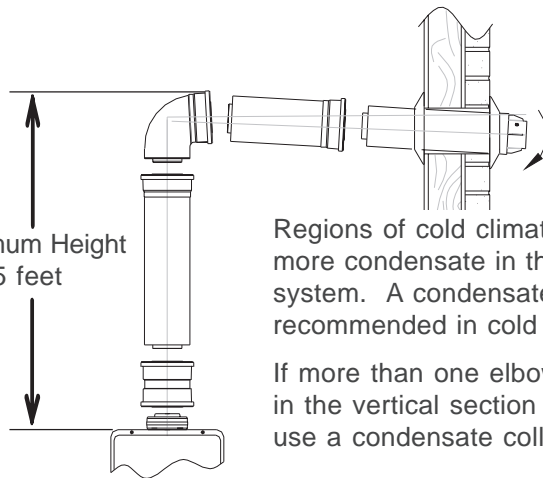

Regions of cold climate will create more condensate in the vent system. A condensate collector is recommended in cold climates.

If more than one elbow is used in the vertical section you must use a condensate collector.

Horizontal Venting with a Condensate Collector

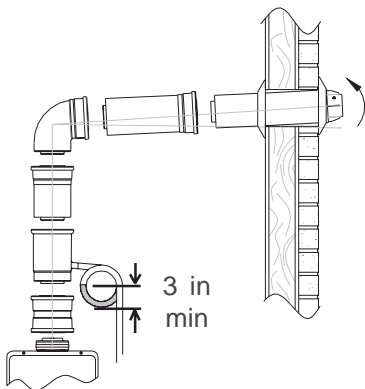

Vertical Venting (condensate collector required)

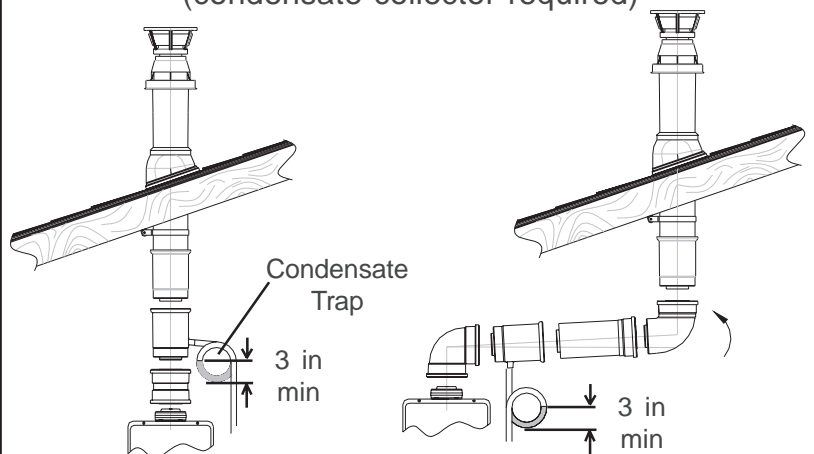

INSTALLER'S INSTALLATION INSTRUCTIONS

Venting

Air Intake and Exhaust Vent Pipe Length

Determine the number of elbows in the vent system. The corresponding number from the table indicates the maximum length of vent pipe.

For high altitude installations contact Rinnai at 1-800-621-9419.

Table 1 Maximum Vent Length (feet)

Number of 90° Elbows						
0	1	2	3	4	5	6
41 (1)	35 (2)	29 (3)	23	17	11	5
Two 45° elbows are considered equivalent to one 90° elbow. Include termination elbows when using this table. (1) If the length is less than 22' then move dip switch no. 1 (SW 1) to ON (2) If the length is less than 16' then move dip switch no. 1 (SW 1) to ON (3) If the length is less than 10' then move dip switch no. 1 (SW 1) to ON						

⚠ WARNING If it is necessary to adjust the dip switch, ensure that no other dip switches are changed. Unauthorized adjustments can cause property damage, personal injury, scalding, or death.

Intake/Exhaust Guidelines

- This water heater is a direct vent water heater and therefore is certified and listed with the vent system. The only vent/air intake system listed for use with this appliance is the Rinnai / Ubbink vent system or the Heat-Fab Saf-T Vent SC system.
- Minimum wall thickness is 4". Maximum wall thickness is 20".
- Do not combine vent components from different manufacturers.
- The vent system must vent directly to the outside of the building and use outside air for combustion.
- Before installation, inspect each vent component for damage and correct seal placement. Do not attempt to fix or install any damaged vent components.
- Every vent connection must be accessible for inspection, cleaning, and replacement.
- Avoid dips or sags in horizontal vent runs by installing supports per the vent manufacturers' instructions.
- Support horizontal air intake runs every four feet and all vertical air intake runs every six feet or in accordance with local codes.
- Venting should be as direct as possible with a minimum number of pipe fittings.
- Vent diameter must not be reduced.
- Do not connect the venting system with an existing vent or chimney.
- Do not common vent with the vent pipe of any other water heater or appliance.
- Vent connections must be firmly pressed together so that the gaskets form an air tight seal.
- Refer to the vent pipe manufacturers' instructions for component assembly instructions.
- The first vent component to the appliance must be an appliance adapter. This will prevent additional components from being installed backwards.

INSTALLER'S INSTALLATION INSTRUCTIONS

Freeze Protection

If the Rinnai water heater is disconnected from either the electrical supply or gas supply, or if there is an error that prevents the water heater from functioning normally, there is **NO FREEZE PROTECTION**. Freeze protection of the water heater is only possible when electricity, gas supply and normal water heater functions are enabled. If you expect freezing conditions while either electricity or gas supply is interrupted, water must be completely drained from water heater.

This water heater and venting system is designed to withstand temperatures to as low as -30°F , so long as electricity and gas are supplied to the product and normal water heater functions are enabled. If either gas or electricity is interrupted **NO FREEZE PROTECTION** is available.

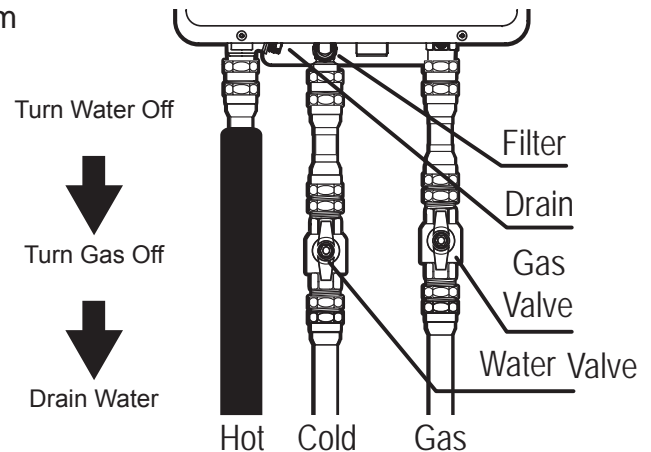

The installation of auto drain down solenoid valves is optional. However, Rinnai strongly recommends that these valves be installed to prevent damage from freezing in case the normal freeze protection should become disabled. If the valves are not installed then any product damage due to freezing will not be covered by the warranty.

NOTE: Rinnai is continually updating and improving products, therefore, specifications are subject to change without prior notice. Local, state, provincial and federal codes must be adhered to prior to installation.

Climate conditions can dictate special applications. Please refer to local codes before installing product.

INSTALLER'S INSTALLATION INSTRUCTIONS

Gas Piping Sizing Chart

Capacity Table for Natural Gas
cubic feet / hour
(table assumes .3 inch pressure drop, specific gravity of .60)

Nominal Iron Pipe Size Inches	Length of Pipe in Feet													
	10	20	30	40	50	60	70	80	90	100	125	150	175	200
3/4	278	190	152	130	115	105	96	90	84	79	72	64	59	55
1	520	350	285	245	215	195	180	170	160	150	130	120	110	100
1-1/4	1050	730	590	500	440	400	370	350	320	305	275	250	225	210
1-1/2	1600	1100	890	760	670	610	560	530	490	460	410	380	350	320

After determining the length of pipe required select the pipe size that will supply the cubic feet per hour of gas required for the input rating of the Rinnai Water Heaters. The formula for figuring the cubic feet per hour required is:

$$CFH = \frac{\text{Gas Input of Rinnai water heater (BTU/HR)}}{\text{Heating Value of Gas (BTU/FT}^3\text{)}}$$

*Gas input requirement is on the water heater data plate

*The heating value of the gas can be obtained from the local Natural Gas Utility

Capacity Table for LP Gas
BTUH of undiluted liquified petroleum gases
(table assumes 11 inches of water column pressure at the inlet, .5 inch drop)

Nominal Iron Pipe Size Inches	Length of Pipe in Feet													
	10	20	30	40	50	60	70	80	90	100	125	150		
1/2	275	189	152	129										
3/4	567	393	315	267	237	217	196	185	173	162	146			
1	1071	732	590	504	448	409	378	346	322	307	275	252		
1-1/4	2205	1496	1212	1039	913	834	771	724	677	630	567	511		

INSTALLER'S INSTALLATION INSTRUCTIONS

Gas Piping Notes

- 1) A manual gas control valve must be placed upon the gas supply line to the Rinnai Water Heater. A union can be used on the connection above the shut off valve for the future servicing or disconnection of the unit.
- 2) Check the type of gas and the gas inlet pressure before connecting the Rinnai Water Heater if the Rinnai Water Heater is not of the gas type that the building is supplied with, DO NOT connect the water heater. Contact the dealer for the proper unit to match the gas type.
- 3) Minimum and Maximum Gas pressures are listed below:
 - * Minimum value is for input adjustment

Natural Gas: Minimum 6" WC
 Maximum 10.5" WC

Propane Gas: Minimum 10"WC
 Maximum 13.5" WC

⚠ WARNING Conversion of this unit from natural gas to propane or propane to natural gas CANNOT be done in the field.

- 4) After completion of gas pipe connections, all joints including the heater must be checked for gas-tightness by means of leak detector solution, soap and water, or an equivalent nonflammable solution, as applicable.

⚠ CAUTION Since some leak test solutions, including soap and water, may cause corrosion or stress cracking, the piping must be rinsed with water after testing, unless it has been determined that the leak solution is non-corrosive.

- 5) The Rinnai Water Heater must be leak tested before it is placed into operation.
- 6) The Rinnai Water Heater and its individual shut-off valve must be disconnected from the gas supply piping system when pressure testing of the gas supply piping system at test pressures greater than 1/2 psi (3.5 kPa).
- 7) Always use approved connectors to connect the unit to the gas line. Always purge the gas line of any debris before connection to the water heater.
- 8) The Rinnai Water Heater must be isolated from the gas supply piping system by closing it's individual manual shutoff valve during any pressure testing of the gas supply piping system at test pressures equal to or less than 1/2 psi (3.5 kPa).
- 9) The Rinnai Water Heater Installation location must provide adequate Combustion and Ventilation airflow.

INSTALLER'S INSTALLATION INSTRUCTIONS

Water Piping Notes

- 1) A manual water control valve must be placed upon the water inlet connection to the Rinnai Water Heater before it is connected to the water line. Unions may be used on both the hot/cold water supply lines, for the future servicing or disconnection of the unit.
- 2) All soldering materials and piping must be compatible with potable water.
- 3) Purge the water line to remove from it all debris and air. Debris will damage the Rinnai Water Heaters.
- 4) There is a wire mesh strainer on the Rinnai Water Heater's inlet to discourage the introduction of debris to the unit. It will need to be cleaned periodically. **DO NOT** operate unit without filter in place. Clean this filter before leaving the job site.

⚠ WARNING DO NOT reverse the inlet and outlet (cold and hot water) connections on the unit. This would cause the Rinnai Water Heater to operate dangerously or not at all.

INSTALLER'S INSTALLATION INSTRUCTIONS

Pressure Relief Valve

- 1) ANSI code calls for the addition of an approved pressure relief valve to all water heating systems.
- 2) The pressure relief valve must meet the following criteria: The relief valve must comply with the standard for Relief Valves and Automatic Gas Shutoff Devices for Hot Water Supply Systems ANSI Z21. 22 and/or the standard CAN1-4.4 Temperature, Pressure, Temperature and Pressure Relief Valves and Vacuum Relief Valves. This relief valve must be rated up to 150 PSI of pressure.
- 3) The relief valve should be added to the hot water outlet line per manufacturer's instructions. DO NOT place any other type valve or shut off device between the relief valve and the hot water heater.
- 4) The discharge from the pressure relief valve should be piped to the ground or into a drain system to prevent exposure or possible burn hazards to humans or other plant or animal life. Water discharged from the relief valve could cause severe burns instantly, scalds and/or death.
- 5) Do not plug the relief valve and do not install any reducing fittings or other restrictions in the relief line. The relief line should allow for complete drainage of the valve and the line.
- 6) If a relief valve discharges periodically, this may be due to thermal expansion in a closed water supply system. Contact the water supplier or local plumbing inspector on how to correct this situation. Do not plug the relief valve.
- 7) Pressure relief valve must be manually operated once a year to check for correct operation.
Caution: See Item 4 before manually operating relief valve.
- 8) Should overheating occur or the gas supply fail to shut off, turn off the manual gas valve on the Rinnai.

INSTALLER'S INSTALLATION INSTRUCTIONS

Lighting the Unit

⚠ WARNING If you do not follow these instructions exactly, a fire or explosion may result causing property damage, personal injury or loss of life.

- 1) This water heater does not have a pilot. It is equipped with a direct ignition device which automatically lights the burner. **DO NOT TRY TO LIGHT THE BURNER BY HAND.**
- 2) Before operating the Rinnai Water Heater smell all around the unit for gas. Be sure to smell near the ground as leaking gas may settle there.
- 3) Turn the manual gas control valve on.

STOP!! READ THE SAFETY ISSUES ON PAGES 8

- 4) Turn on any hot water tap. The Rinnai Water Heater should light and begin heating your water.

If the Rinnai Water Heater fails to light

- 1) **DO NOT ATTEMPT TO LIGHT BY HAND.**
- 2) Turn off the electrical power to the unit.
- 3) Turn off the manual gas control.
- 4) Wait 5 minutes, if you smell gas, go to a neighbor's house and call the gas company or the fire department. If you do not smell gas, go to the next step.
- 5) Turn the manual gas control valve on.
- 6) Turn the electrical power to the unit on.
- 7) Turn on any hot water tap.
- 8) If the unit still fails to light, turn off the electricity and gas to the unit and call Rinnai 1-800-621-9419.

INSTALLER'S INSTALLATION INSTRUCTIONS

Remote Controllers- General

The remote controls for the Rinnai Water Heater allow the customer to control the functions of the water heater and to diagnose certain fault conditions.

Before installing the remote controllers, determine the most convenient location(s). When deciding on the best location for the remote controllers, consider the following items:

- 1) Place the controllers out of reach of small children.
- 2) Avoid locations where the controller(s) will become hot (over the stove, near the oven or a radiant heater).
- 3) Avoid direct sunlight (The digital display can be difficult to read in direct sunlight).
- 4) Avoid areas where the remote controller can be splashed with water, oil, sauce, etc.
- 5) The remote controller cables carry low voltage, 12VDC digital.

NOTE: Controllers have to be wired in Parallel. Each Controller can share the same feeder circuit wire.

Controllers cannot be wired in series.

Controller Connection in Parallel

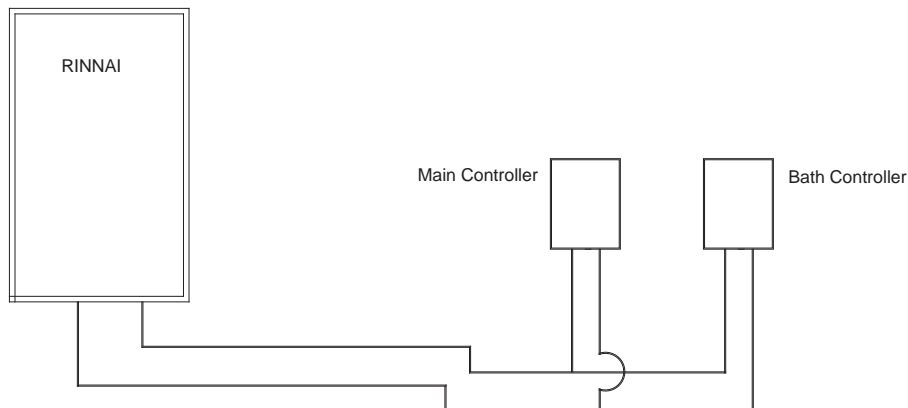

⚠ WARNING

When the Temperature Controller is used in public applications, it should be installed where it can not be adjusted by the public (i.e. a maintenance room or manager's office).

NOTE: The Temperature Controller(s) have default temperature settings for the Rinnai Water Models. See Controllers Set Pattern page for details.

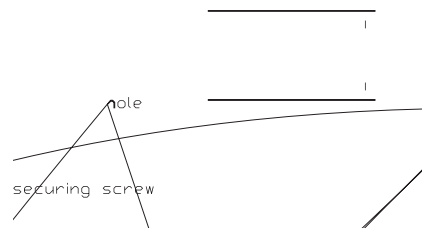

Remote Controllers Installation to Appliance
 For models : V2520FFUD/FFUCD and V2532FFUD/FFUCD

- 7) Disconnect the power from the Rinnai Water Heater.
- 8) Remove a screw on the Quick Cable Connector. (Fig1)

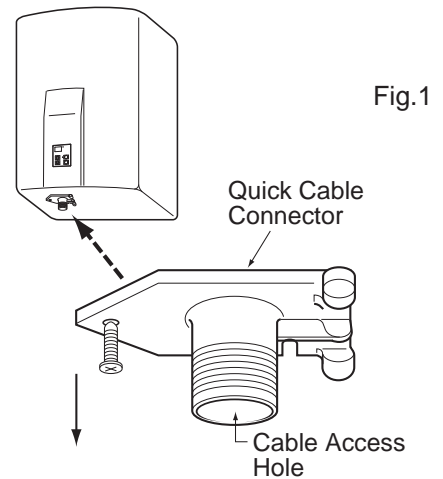

- 9) To access Cable Screws rotate the Quick Cable Connector 90° counter clock wise. (Fig.2)
- 10) Insert wire cable through the Cable Access Hole so that it can be accessed from the back. (Fig.2)

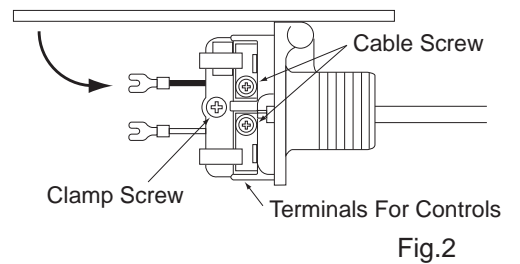

- 11) Loosen two Cable Screws on the Terminals For Controls and connect the cable accordingly. You can not connect more than two cables at a time. If more than two, please connect in parallel. (Fig.3)

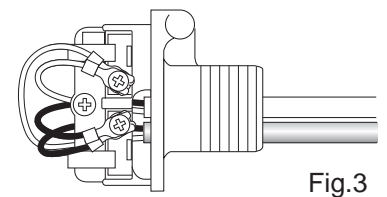

- 12) Loosen the Clamp Screw and affix wire cable with clamp. Clamp is in a carton box of Remote Controller. Please make allowance for wire to eliminate tension. (Fig.4)

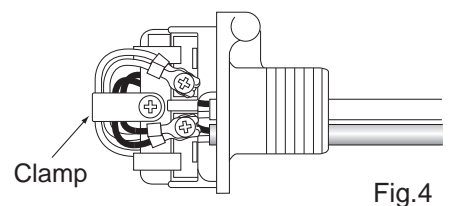

- 13) Install the Quick Cable Connection as before. (Fig.5)

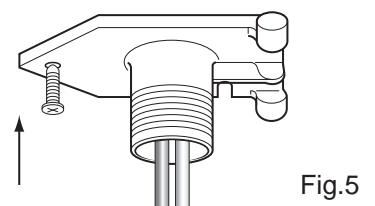

INSTALLER'S INSTALLATION INSTRUCTIONS

Testing

- 1) Turn on the gas and water.
- 2) Check for water and gas leaks. Use soapy water to test for gas leaks.
- 3) Remove pressure test point screw, attach pressure gauge to test point.
- 4) Turn Power on.
- 5) Open any hot water tap fully.
- 6) Check test point or supply pressure in water columns per inch.

Natural Gas Inlet and Manifold Gas Pressure by Model

Model #	Inlet Gas Pressure	Manifold Forced Low Fire	Manifold Forced High Fire
REU-V2520FFU Series REU-V2520FFUD Series	6" - 10.5"	0.77"	3.7"
REU-V2532FFU Series REU-V2532FFUD Series	6" - 10.5"	0.77"	3.7"

Propane Gas Inlet and Manifold Gas Pressure by Model

Model #	Inlet Gas Pressure	Manifold Forced Low Fire	Manifold Forced High Fire
REU-V2520FFU Series REU-V2520FFUD Series	10" - 13.5"	0.93"	4.2"
REU-V2532FFU Series REU-V2532FFUD Series	10" - 13.5"	0.93"	4.2"

NOTE: The pressure may be low due to too little flow, too high an incoming temperature, and/or undersized gas piping. Examine these areas before determining that the pressure needs to be adjusted. Contact Rinnai before adjusting manifold pressures at 1-800-621-9419. Failure to contact Rinnai, could void unit's warranty.

- 7) If it is determined that the gas pressure needs adjusting, first check the incoming pressure at the test point on the gas inlet. If it is correct follow the adjusting procedure contained in the pouch of the unit EXACTLY.

The regulator is pre-set at the factory, it should not need resetting.

- 8) Turn the hot water off. Turn the power off. Remove the pressure gauge and replace the test point screw. Check for a gas leak around the test point screw.
- 9) Replace the front cover.
- 10) Turn the power back on.
- 11) Check the operation of the unit. Check the operation of each of the remote controller(s). Check the operation of the Power failure protection system.
- 12) Explain the proper operation of the Rinnai Water Heaters to the customer.

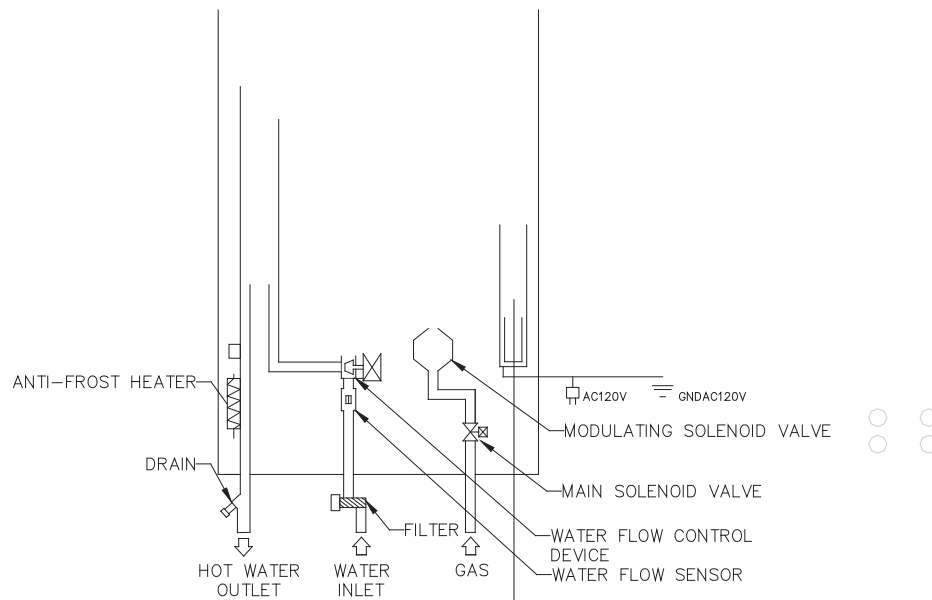
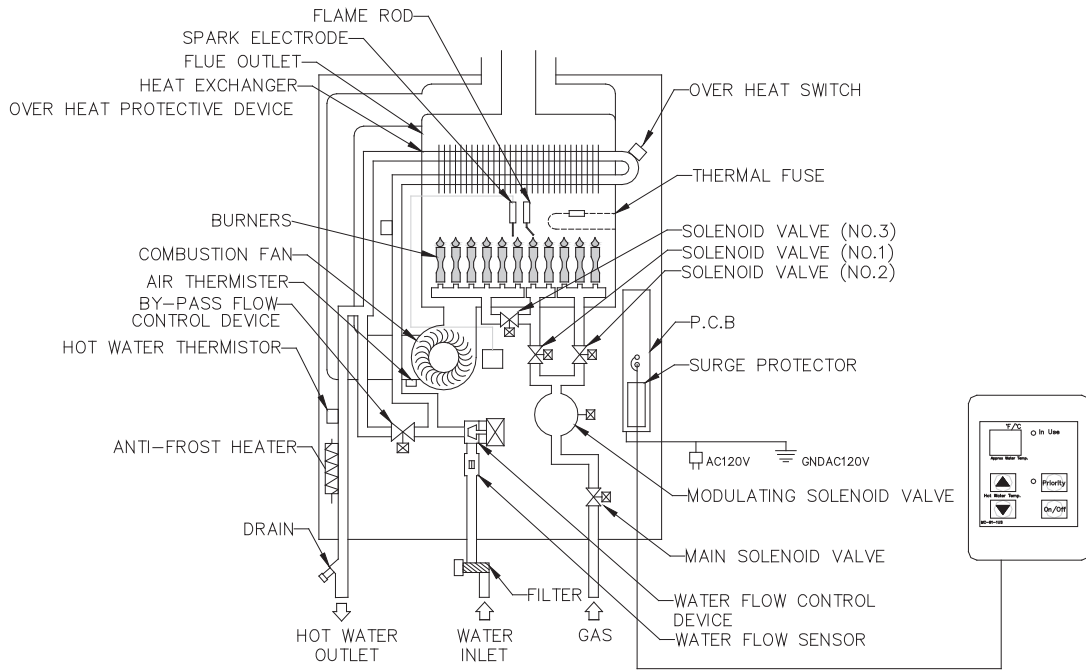

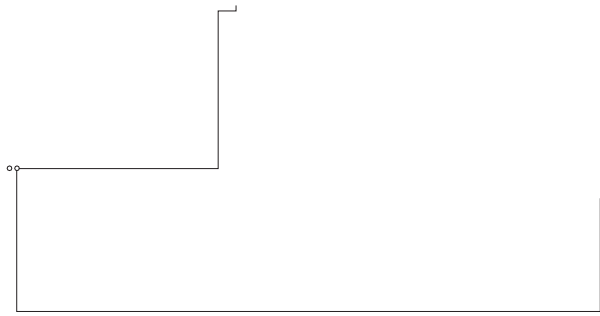

Ask about

WWW.RINNAI.US OR 800-621-9419

Rinnai's other fine products.



Direct Vent Heaters

- "Cool-to-the-Touch" cabinet
- Easily Installed and Safe for Any Room
- Up to 84% Efficient
- Electronic Ignition - No Pilot Light
- Propane or Natural Gas
- Earthquake Proof-Off Switch
- Whisper Quiet Blower
- Primary Heat Source

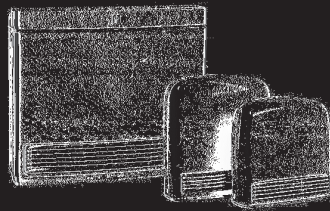

Vent-Free Zone Heaters

- Programmable Thermostat
- 99.9% Efficient Ventless
- No Visible Flame
- Oxygen Depletion Sensor
- Secondary Heat Sources

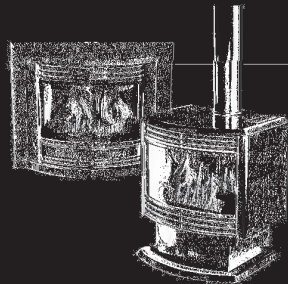

Free Standing and In-Built Fireplaces

- Standard Dimensions
- Thermostat Control
- State-of-the-Art Three Gas Burner System
- Electronic Push Button Ignition
- Remote/Keypad Control
- Programmable Thermostat

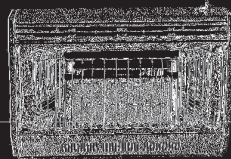

Infrared Heaters

- Wall-mountable or Free-standing
- Works in Power Outages
- 99.9% Energy Efficient
- Natural or Propane Gas
- ODS Safety Sensor
- Ideal for Emergency Heating

Rinnai
[1-800-621-9419] [WWW.RINNAI.US] [RINNAI@RINNAI.US]

Rinnai America Corporation
1831 International Drive
Reshico City, GA 30769

U245-3250X01(00)
Printed in Japan_06/03