



Designed for the real world

Instructions for Installation and Use

Ultima SDW80 & SDW85

45cm free standing

Dishwasher

To the Installer

**Before installation fill in the product details on the back cover of this book.
The information can be found on the rating plate.**

To the User

**You must read the instructions prior to installing and using the appliance and
then retain them for future reference.**

Contents

Electrical Connection	4
For Your Safety	5
Installation	6-7
Before Using your Dishwasher	8-9
Loading your Dishwasher	10
What Can I Wash	10
Getting to know your Dishwasher	11
How to use your Dishwasher	12
Programme Chart	13
Care and Cleaning	14
Troubleshooting	15
Information for Test Labs	16
After Sales Service	17
Hotpoint Guarantee	18
Key Contacts	Back Cover

Retention of this Instruction Book

This Instruction Book must be kept handy for reference as it contains important details on the safe and proper use of the appliance.

If you sell or pass the appliance to someone else, or move house and leave it behind, make sure this Book is also provided so the new owner can become familiar with the appliance and safety warnings.

If the Book is lost or damaged a copy may be obtained from:

Merloni Elettrodomestici UK Ltd. Morley Way, Peterborough, PE2 9JB

Electrical Connection

WARNING: This appliance must be earthed.

Fuses

Your appliance comes fitted with a plug and a 13A fuse. If you need to replace the fuse, only those rated at 13A and ASTA approved to BS1362 should be used. If you lose the fuse cover, a replacement may be obtained from your local authorised Service Centre or Electrical company. Correct replacement is identified by colour coding or the marking on base of plug.

WARNING: DO NOT use the plug unless the fuse cover is fitted.

Changing the Plug

Cut off and dispose of the supplied plug if it does not fit your socket.

WARNING: To avoid a shock hazard DO NOT insert the discarded plug into a socket anywhere else.

IMPORTANT: WIRES IN THE MAINS LEAD ARE COLOURED IN ACCORDANCE WITH THE FOLLOWING CODE:

Green/Yellow	-	Earth
Blue	-	Neutral
Brown	-	Live

If you change the plug, the colour of the wires in the mains lead may not correspond with the terminal markings in the plug, which if not coloured, could be:

EARTH	'E' or	
NEUTRAL	'N'	
LIVE	'L'	

Changing the Mains Lead

A lead can be ordered from Hotpoint Service
UK: 08709 066 066 or
Republic of Ireland: 1850 302 220

If you have damaged the existing lead or require a longer one a charge will be made. It is strongly advised that this work is carried out by a qualified electrician.

If the domestic wiring includes a residual current-operated circuit breaker, ensure that it conforms to the latest regulations.

Safety Information

At the time of delivery...

All functions of your dishwasher have been thoroughly tested at the factory.

A small number of water marks may have been left as a result, they will disappear when the appliance is used for the first time.

WARNING: The dishwasher must not be connected to the electricity supply while installation is being carried out.

- This appliance should only be connected to a 230/240V AC source, via a properly installed earthed socket.
- Use the dishwasher solely in a domestic environment.
- DO NOT stand or place heavy objects on the door when it is open, this could damage the door or cause the appliance to tip forward.

If your family includes children...

- DO NOT allow children to play with the appliance or tamper with its controls.
- Keep detergents and rinse aids away from children. Keep children away from the open door of a dishwasher, there could still be some detergent left inside.

CAUTION:

The dishwasher meets the requirements set out by the regulations in force concerning safety and electrical equipment.

Any technical checks should be conducted exclusively by a trained and authorised technician: Repairs carried out by unauthorised persons will invalidate the guarantee, as well as posing a potential hazard to the user.

The manufacturer declines all responsibility for damage to persons or property resulting from failure to observe the above precautions, from tampering with even a single component or from the use of non-original spare parts.

For your Safety

This manual forms an integral part of the appliance. It must always be kept handy for reference. Read through all the instructions contained in this manual before using the dishwasher.

Installation must be performed by a qualified technician, in compliance with the regulations in force, including the prevention and elimination of radio frequency interference.

The dishwasher is designed for washing and drying dishes, any other use shall be considered improper. The manufacturer declines all responsibility for uses other than those described above.

1. Separate the various packaging materials and dispose of safely - DO NOT leave discarded packaging material around the home.
2. After removing the packaging, check to make sure your appliance is intact. If in doubt, contact a qualified professional.
3. DO NOT use extension leads and multiple plugs. If the electricity supply wire is not long enough, then have it replaced with one of the correct length and remember that it should be free of bends or dangerous kinks.
4. In the event of any damage to the power cord have it replaced by a qualified technician.
5. **The mains plug must be easily accessible after installation.**
6. **If the appliance is not operating properly or if maintenance operations are necessary, disconnect the dishwasher from the mains power supply (unplug it!).**
7. DO NOT install outdoors, not even if the area is covered by a roof: it is extremely dangerous to leave it exposed to rain and thunderstorms.
8. If installed on a carpeted or covered floor, ensure that the openings on the underside are not obstructed.
9. Do not touch the heating element during or straight after a wash cycle.
10. If the appliance malfunctions, turn off the water inlet tap and disconnect the plug from the wall socket. Then read the section entitled "Troubleshooting". If you cannot resolve the problem, then call Hotpoint Service (see KEY CONTACTS, back page).
11. Cutlery and sharp utensils should always be inserted in random order with the blades pointing downwards (take care with knife blades).
12. For your own safety, ensure the door is closed when the dishwasher is not in use.

The rating plate, featuring the technical data, serial number and markings, is visibly positioned on the inner edge of the door. DO NOT remove the rating plate.

The dishwasher is intended for use by adults: DO NOT allow children to come near or play with the controls.

Keep children away from detergents and clear of the dishwasher door when open.

Keep all packaging material away from children.

1. DO NOT use solvents, such as alcohol or turpentine which may cause an explosion.
2. DO NOT load dishes to wash that are soiled with ash, wax or paints.
3. DO NOT lean, sit or stand on any part of the dishwasher - this could cause injury and/or damage the appliance.
4. DO NOT drink any water residues from inside the dishwasher.

Installation

Choose where you want to install your dishwasher, you can place it so that its sides or back panel are side by side with furniture or up against the wall. The dishwasher is provided with water supply and drain hoses, which can be directed towards the left or right to facilitate appropriate installation.

Levelling.

Once the appliance is positioned, adjust the feet by screwing them in or out depending on how high you want it and to level it so that it is horizontal. Make sure that it is not inclined more than 2 degrees. If the appliance is level, it will help ensure its correct operation.

Cold water connection.

Connect the cold water supply hose, and making sure that it is fastened tightly in place. If the water hoses are new or have been out of use for an extended period of time, let the water run to make sure it is clear and free of impurities before making the connection. If this precaution is not taken, the water inlet could get blocked, causing damage to your dishwasher.

Connect to the Water Supply...

- For your dishwasher to operate correctly it requires water pressures in the range of 6-150 psi (100-1000KPa). Most cold water supplies will be in this range. NOTE: low water pressure will lead to excessively long fill times or no fill.
- Ensure that the new hose supplied is connected and the old hose is disposed of safely.
- Ensure the fill hose is only fitted to the cold water supply. DO NOT overtighten the hose connector, hand tight is sufficient.
- Ensure the fill hose is not kinked.
- Tap connections (if applicable): A range of adaptors (if available) to suit your tap.
- DO NOT connect the dishwasher to a single outlet instantaneous water heater or an electric heater.

Drain hose connection.

WARNING: Connect your dishwasher drain hose to pipes which connect to the foul drain system and not to surface water drains.

IMPORTANT: For the correct operation of your dishwasher, it is essential to comply with the following information:

Standpipe:

Ensure that the hose is not pushed too far down the standpipe. If the end of your drain hose is fitted with 'retaining flaps', ensure they are inserted fully into the standpipe. This will prevent the pipe from jumping out during installation and use.

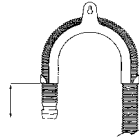

DO NOT position the standpipe near an electrical outlet. ENSURE that the drain hose is not kinked and it is routed as shown in the diagram.

The standpipe should have a bore of at least 38mm (1 1/2"). It should be installed as shown, have a trap fitted and must discharge into the same drain system as your household sink.

It MUST NOT be connected to a surface water drain.

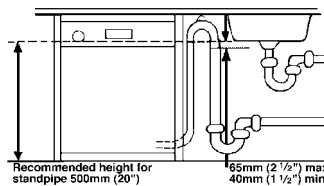

Sink Waste System:

For under sink drainage: Before connecting the drain hose, remove any internal restrictions - This will prevent a build up of debris which could cause a blockage. Remove any restrictions from the waste spigot and ensure that the sealing bung is removed. The hose should be routed, such that it is raised to a minimum height of 800mm (31 1/2").

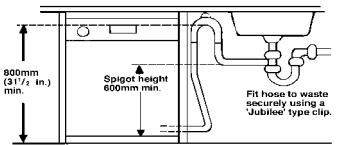

NOTE: Ensure the sink outlet pipe has a minimum diameter of 32mm.



1. Untie the end of the GREY drainage hose from the rear of the appliance.
2. Reposition the 'Hooked End Support' as required along the GREY drainage hose.
3. If fitting an under sink waste disposal unit, cut out the membrane, bung or blanking plug.

Ensure the drain hose is securely attached, to prevent it coming away while the machine is in use and causing a flood.

Remember you will be charged for a service call if a problem with your appliance is caused by incorrect installation or misuse.

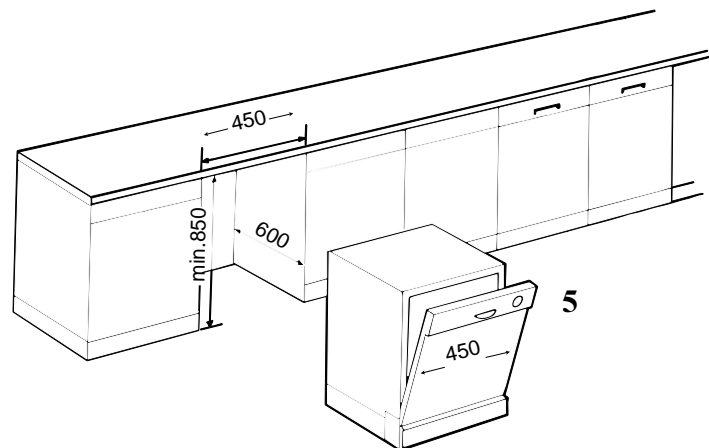
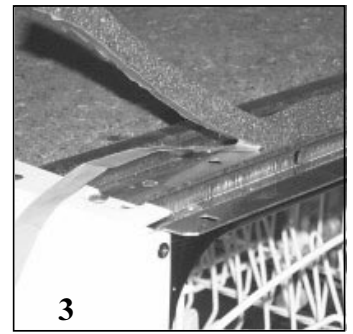
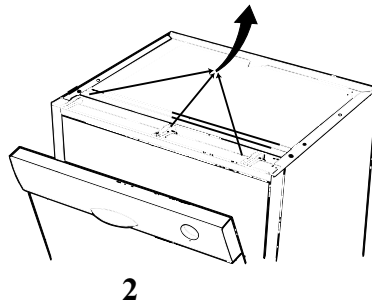
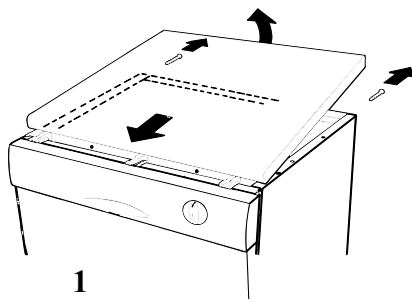

INSTRUCTIONS FOR INSTALLING THE DISHWASHER IN FULLY-FITTED KITCHENS.

Your free standing dishwasher can be installed in modern kitchens as follows:

- **to stand next to furniture units or other electric household appliances**
(Please read the chapter on "Installation" in the instruction manual.)

- **to insert or built-in under the one worktop.**

Should it be necessary to remove the top shelf of the dishwasher, proceed as follows:

- Unscrew the 2 rear screws and then, with a light push forward, let it slide out and remove it (see fig.1)
- Discard the polystyrene rectangle.
- Open the door and, after unscrewing the fixing screws, remove the 3 plastic plugs used to hook the shelf on (fig.2)
- Glue on the small soundproofing adhesive spongy strip onto the top crosspiece (photo 3) and, after tilting the appliance, glue on another one underneath the base (photo 4).
- Straighten up the appliance and adjust the front and back feet by unscrewing them in an anti-clockwise direction to raise the dishwasher to the required height.
- Insert the appliance underneath the worktop (fig.5), checking that the inlet and outlet pipes do not get bent or squashed (please read the instructions provided in the "Installation" chapter).
- Open the dishwasher door and glue on the two equal-sized adhesive spongy strips on the front edge of the appliance cabinet. Begin from the top without leaving out any spaces and make sure the strips adhere all along the length of the edge. A small part of the spongy strip protruding onto the outside will block any light left between the dishwasher and adjacent cabinets, thus improving the soundproofing.

Warning:

The dishwasher plug must be within access once the appliance has been built in, in order to allow for maintenance to be carried out safely.

The structure of your dishwasher makes it impossible to fit it under a hob.

Before Using your Dishwasher

The detergent

Each time you load the dishwasher, add detergent. Pour dishwasher detergent into the dispenser on the inside of the door.

Adding detergent

To open lid A, press button B.

The detergent should be put into the two containers C and D.

If using a tablet, put it in container "D".

Now you can close the lid: press it down until you hear it click.

If it won't close

Check whether there is any detergent residue on the edges of the dispenser. Remove the excess.

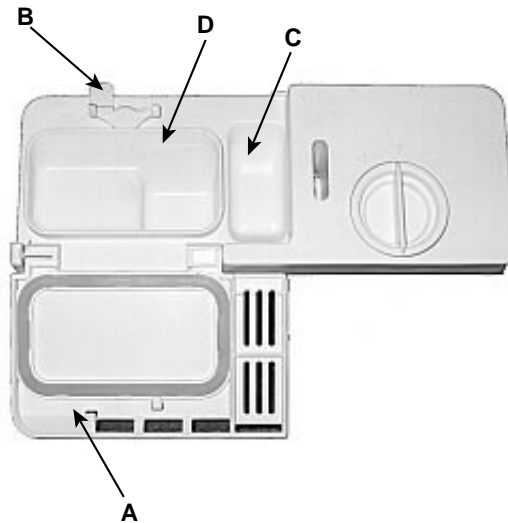

- Use the right amount of detergent (see programme chart).
- Store your detergent and rinse aid in a cool, dry place, safely away from children.

We recommend Glist 3 in 1 for use in all Hotpoint dishwashers...

Brilliant cleaning is guaranteed with **Glist 3 in 1**.

Hotpoint only recommends Glist 3 in 1 Dishwasher tablets to give outstanding cleaning and care.

It is important to use detergent specially designed for domestic dishwashers. (Always follow the manufacturers instructions.)

Glist 3 in 1 advanced dishwasher tablets with active enzymes are the ideal way to protect and care for your dishwasher, while getting your dishes and glasses sparkling clean.



*If you live in an area particularly prone to very hard water (>35°f) Glist and Hotpoint recommend that you continue to keep your dishwasher salt topped up.

Softer Water:

Built in salt action softens water, helping to prevent the build up of limescale in the dishwasher and improve the cleaning result*.

Cleaner Dishes:

With unique active enzymes in the cleaning phase **Glist 3 in 1** breaks down even the hard to shift foodstuffs and grease, leaving the dishes spotless and the dishwasher clean too.

Sparkling Results:

The built-in Glist rinse agent ensures the dishes and glasses are free from water marks and smears.

If you have any questions regarding **Glist 3 in 1**, please contact the hotline on 0800 216 730.

Rinse aid.

This product makes dishes sparkle more as it improves their drying. The rinse aid container is situated on the inside of the door: It should be filled up when the low rinse aid indicator light "U" flashes on the display.

Adding rinse aid.

To open the dispenser, turn cap C anticlockwise. Take care when you pour in the rinse aid to avoid it overflowing.

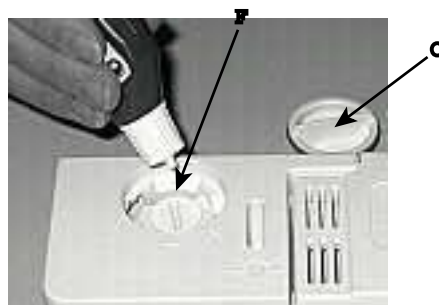

You can regulate the amount of rinse aid used by the dishwasher, move the adjuster F which you will find under lid C.

You can choose from six different positions. It is normally set to 4.

- The amount of rinse aid needs to be increased if the dishes appear dull or you can see circular stains.
- The amount of rinse aid needs to be reduced if the dishes are sticky or you can see white streaks.

Before Using your Dishwasher

Adjusting the water softener.

Water hardness varies according to where you live. If the water in your home is hard, without water softening, incrustations would form on your dishes. Your dishwasher is fitted with a water softener which uses special salt to get rid of limescale in the water.

Your dishwasher can adjust its salt consumption according to the hardness of the water in your home. This way, you can optimise and customise your dishwasher's salt consumption.

To adjust salt consumption, do as follows:

1. Unscrew the salt container cap
2. There is an arrow on the neck of the container (see figure): if necessary, turn the arrow anti-clockwise from the "-" setting to the "+" setting.

Select the arrow position depending on the water hardness, referring to the table.

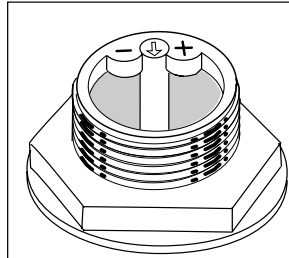

Salt Tap

IMPORTANT:

Only use recommended dishwasher salt. DO NOT use everyday table salt, cooking salt, as they contain insoluble substances which could harm the dishwasher.

Water Hardness					
Clarke degrees	°fH	mmol/l	Selector position	Salt consumption (grams/-cycle)	Autonomy (cycles/2-kg)
0 - 14	0 - 17	0 - 1,7	/	0	/
14 - 36	18 - 44	1,8 - 4,4	"-"	20	60
36 - 71	45 - 89	4,5 - 8,9	MED	40	40
>71	> 89	> 8,9	"+"	60	25

You don't know how hard the water in your home is? Ask the company that supplies water in your area.

Salt

Filling the salt container.

Always use salt which is intended for dishwasher use.

The salt container is situated underneath the lower basket, fill it up as follows:

1. Pull out the lower basket completely, unscrew and remove the container cap
2. If it is the first time you add the salt, first fill the container up with water (you won't have to do this again next time)
3. Put the dishwasher funnel on the hole and pour in approximately two kilos of salt. It is normal that some water comes out of the container.
4. Screw the cap back in place carefully.

When to add salt:

The salt container should be filled up when the low salt indicator light "T" flashes on the control panel.

When you have loaded salt for the first time, it is normal for the low salt indicator light to stay on for at least 5 consecutive cycles.



WARNING:

DO NOT pour detergent into the special salt container. This will destroy the water softener.

Warning

Three-in-one dishwasher tablets are now available on the market, and combine detergent, salt and rinse aid all in one. If the water in your area is hard or very hard, we still recommend you pour extra salt into the relevant dispenser to prevent the formation of white streaks on your dishes or on the interior of the appliance.

Using a three-in-one product means it is no longer necessary to put rinse aid into the relevant container.

If you want to achieve perfectly dry dishes, you may add rinse aid as long as the dosage adjuster is set to no.2.

In any case, please read the manufacturer's instructions on the packet.

If you use only these products, it is normal for the salt and rinse aid indicator lights to flash permanently after a certain number of cycles.

Loading your Dishwasher

First of all.

Before placing dishes in the baskets, remove all course food remains. This avoids blocking the filter, which would reduce the efficiency of the wash.

If saucepans and frying pans are very dirty, allow them to soak before being washed.

To make it easier to load your dishes, pull the baskets out.

What goes into the upper basket?

Place delicate and lightweight dishes in the upper basket: glasses, tea cups and coffee cups, saucers and plates - shallow salad bowls, slightly dirty frying pans and shallow pans. Position lightweight dishes in such a way as to avoid their being moved by the spray of water.

The dishwasher can also be equipped with one or two tip up compartments onto which you can place mugs and cups, as well as long sharp knives and serving cutlery.

After loading the dishes, remember to check that the spray arms can turn freely without hitting against any dishes.

How to adjust the upper basket.

The upper basket can be set in high or low position to enable you to organise your dishes effortlessly.

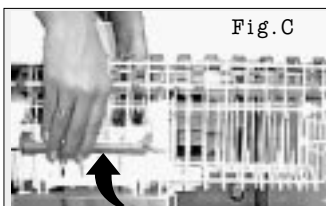

There are two handles on the sides of the upper basket, use these to adjust its height (see fig.C).

What goes into the lower basket?

We recommend you place the most difficult dishes to wash into the lower basket: saucepans, lids, soup dishes and plates (a load example is shown in the photo).

- **Serving dishes and large lids:** place them on the sides of the basket.
- **Saucepans, salad bowls:** must always be placed upside down
- **Very deep dishes:** place them obliquely, thus allowing water to run down them and cleaning them better
- **Glasses and cups:** position them as shown in load example photo.

The lower rack has tip-up sectors (see figure B), so you can place even more saucepans and frying pans or make room for the larger one

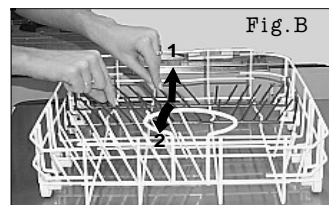

Place the cutlery with the handles at the bottom; if the basket is the one with side inserts, then insert the tea spoons one by one into the slots (see figure A).

This basket is equipped with one removable grid: insert the cutlery one by one into the slots, with the handles at the bottom.

Knives and utensils with sharp blades or tips should be positioned with the sharp parts at the bottom. Position all cutlery items so that they don't touch.

It is best if you place longer utensils horizontally at the front of the upper rack. It is best if you place longer utensils horizontally at the front of the upper rack.

Load examples

lower basket

upper basket



What can I Wash *Items not suitable for the dishwasher:*

- Cutlery and tableware made from wood or part wood - They may become faded and unsightly in appearance.
- Avoid washing horn handled and bronze cutlery in the machine.
- Delicate/decorative glassware and vases, special antique or irreplaceable china - the decorative patterns printed on these items will not be dishwasher proof.
- Plastic objects that are not resistant to hot water.
- Copper and Pewter utensils. Aluminium and Silver objects.
- Some types of glass can become opaque in appearance after they have been washed too many times in a dishwasher.
- Highly absorbent materials such as sponges and towels should never be placed in a dishwasher.
- **If in any doubt, check with the manufacturer on items suitability for dishwasher's.**

WARNING: Dishes or cutlery soiled with tobacco ash, wax, lubricating grease or paint should not be put in the dishwasher.

Our recommendation: In future, only purchase table or kitchenware that has been confirmed - dishwasher proof.

Getting to know your Dishwasher

1. Basket height adjuster
2. Top spray arm
3. Salt container cap
4. Bottom spray arm
5. Upper basket
6. Lower basket
7. Washing filter
8. Detergent and rinse aid dispenser

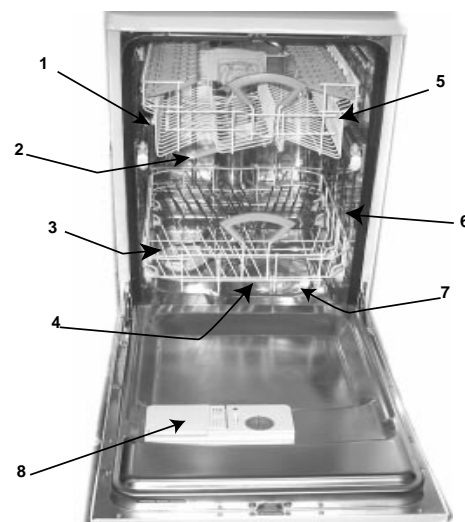

The Controls

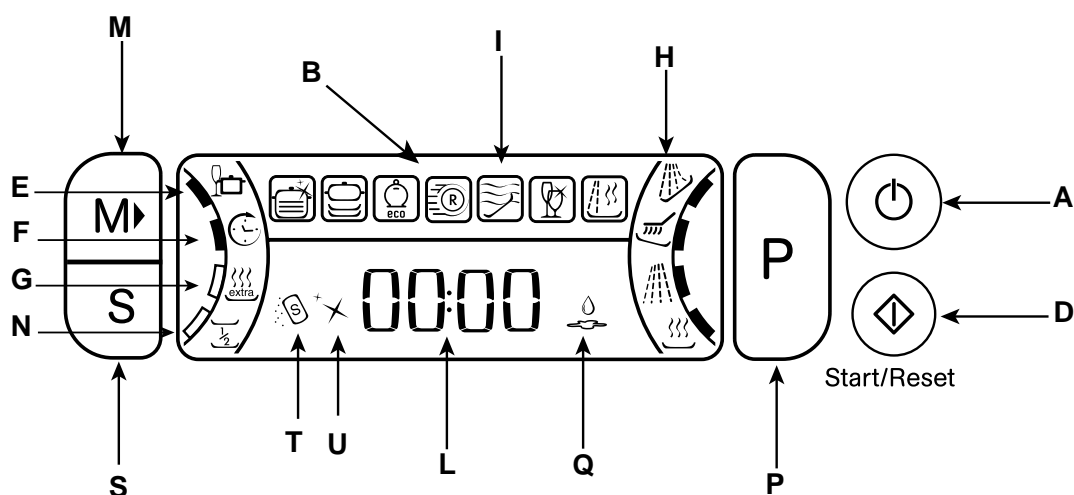

- A. ON-OFF display button**
Press this button to turn the display on.
- B. Display**
Displays the functions in progress.
- D. Start/Reset button**
With Start, the wash cycle begins, whereas all the settings are cleared with Reset.
- E. Auto Duo-Wash cycle indicator light**
To remind you that the Duo-Wash cycle has been set.
- F. Delayed Start indicator light**
This indicates that delayed start has been set.
- G. Extra drying indicator light**
To indicate that extra drying has been set.
- H. Cycle phase indicator lights**
Pre-Wash, Wash, Rinses, Drying.
- I. Wash cycle symbols**
A wide range of wash cycles to choose from.
- L. Multifunction numeric indicator**
Informs you the duration of the cycle, the amount of time left to wait and any error codes.
- M. Mode button**
Press this button to select the auto Duo-Wash cycle, the Delayed Start, the extra drying and the half load.
- N. Basket indicator**
Shows which basket you have selected for the Half Load.
- P. Cycle select button**
Press this button to select the desired cycle.
- Q. Water leak indicator light**
To warn you of a water leak.
- S. 'Selection' button**
Press this button to select the following functions: Delayed Start, Extra Drying, Basket selection.
- T. Low salt indicator light**
This light tells you that it is time to add more salt.
- U. Low rinse aid indicator light**
This light tells you that it is time to add more rinse aid.

Technical characteristics

Width	cm. 45
Depth	cm. 60
Height	cm. 85
Capacity	9 standard place settings
Mains water pressure	4,3 psi - 145 psi 30KPa ÷ 1MPa (0,3 ÷ 10 bar)
Power voltage	See data plate
Total absorber power	See data plate
Fuse	See data plate

This dishwasher conforms to the following European Community Directives:

- 73/23/EEC of 19/02/73 (Low Voltage) and subsequent modifications;
- 89/336/EEC of 03/05/89 (Electromagnetic Compatibility) and subsequent modifications;
- 97/17/CE (Labelling)

How to use your Dishwasher

First of all.

- Plug in and switch on.
- Turn on the water supply tap completely.
- Add the correct amount of detergent.
- Load the baskets correctly.
- Check that the spray arms rotate freely.
- Close the door securely.
- Press the Stand-by button "A". The display turns on and 4 dashes appear, these indicate that the dishwasher is now awaiting instructions.

Select the wash cycle.

Select the wash cycle by pressing button "P". Each time you press the button, a beep will sound and the corresponding symbols will light up in sequence.



Select the wash cycle most suitable for the type of dishes to wash (see 'Programme Chart').

Press and hold the Start button "D" for a few seconds and the wash cycle begins. If you left the door open, the word 'DOOR' will be displayed - shut the door and press the Start button again.

A beep sounds: the wash cycle has started and only the symbol corresponding to the selected wash cycle is displayed.

You can see the amount of time left until the end of the wash cycle on the counter "L".

- Do not expect a precise countdown as the wash cycle starts with an estimated cycle time and the sensor automatically updates this as the cycle progresses (time would be affected by such things as water temperature and degree of soiling).

Indicator lights.

Cycle phase indicator lights "M" keep you informed. Each will light up to show you which cycle

Have you left the dishwasher door open?

The word 'DOOR' will flash up on the display. Shut the dishwasher door and the selected wash cycle will start.

phase is in progress: Pre-Wash, Wash, Rinse or Drying.

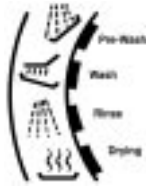

Modifying a wash cycle in progress.

If you have chosen the wrong cycle - You can modify the wash cycle, if it has only just started. Keep the Reset button "D" pressed in for a few seconds, a prolonged beep will sound, followed by 3 short beeps.

The wash cycle symbol will go out and 4 dashes appear to show that all settings have been cancelled. You are now able to reselect the correct wash cycle that you require.

You've left out a dish?

Interrupt the wash cycle by pressing the Stand-by button "A". Open the door and insert the dish you had forgotten, close the door and press the same button again.

The cycle will start up from where you interrupted it.

Cycle end

The end of the wash cycle is indicated by 2 short beeps and the word 'END' flashes up on the display.

Warning:

Turn the display off by pressing the Stand-by button "A". unplug the appliance from the electricity socket to cut off the power supply; the power supply cable should consequently be easily accessible.

Turn off the water tap.

Wait a few minutes before unloading the dishes: they are very hot! If you wait a little while, they dry better due to the steam.

Empty the lower basket first.

Ensure the wash cycle has ended before attempting to remove any dishes.

Delaying the start of a programme.

When you have loaded the dishes, you can choose when to start your dishwasher before setting the wash cycle desired.

Press button "M" (Mode) and then select the symbol corresponding to the Delayed Start . The rectangle alongside will darken to show selection. Now press button "S" to select the delayed start by 1 to 24 hours. If you press this button again, the word 'OFF' is displayed (no selection made).

Each time the button is pressed, a beep will sound - Once you have made your selection make sure the door is shut and press the Start button "D".

The countdown to the start is displayed. When this time elapses, the wash cycle begins and the time left will come up in the display.

Have you changed your mind?

If you decide you require a different delay start period, press the "M" (Mode) and "S" (Select) buttons and make a different selection.

If you want to cancel the delay start and start the selected wash cycle immediately, press the "S" (Select) button repeatedly until it is set to zero. The  indicator will turn off.

The delayed start is also reset automatically, should you fail to select a wash cycle within 15 seconds.

Duo-Wash cycle



This is a special cycle that runs a different wash on the two basket positions.

- Upper basket: delicate, for glassware and glasses.

- Lower basket: heavy duty, for saucepans and frying pans.

Press button "M" (Mode) and then select the symbol corresponding to Duo-Wash and press button "S" (Select) 'on' means it is selected and the rectangle alongside it will light up, whereas 'off' means it is disabled. After approximately 5 seconds you will automatically quit the menu. Now press Start and the wash cycle start is indicated by a beep.

Half load.

This option is available with all wash cycles.

Your dishwasher also allows you to wash half a load (using one basket), to save water, electricity and detergent (use only half the amount). Press button "M" (Mode) repeatedly until symbol "N" is selected, the corresponding rectangle will light up.

Using button "S" (Select) you can decide to wash a half-load on either: The upper basket $\frac{1}{2}U$ or the lower basket $\frac{1}{2}L$. Each time you press the button you will hear a beep and the corresponding symbol will light up. When no symbol is lit it means no selection has been made. Once you have made the selection, press Start to begin the wash cycle.

"Extra" drying

If you want your dishes to be perfectly dry:

press the button "S" to select the extra-dry, select the basket/s to be used and delayed start if required. Indicator "G" will show symbol 

when it has reached the drying phase. The symbol will flash for approximately 4 seconds and the word OFF appears on the display (extra drying disabled). If you immediately press button "D" Start, you will hear a prolonged beep and the word ON will appear on the display and extra drying has been selected.

Once you have completed all your selections, shut the door. You will hear a beep and the wash cycle will start, either immediately or after the delayed start if selected. Remember that with extra drying selected the programme will last longer.

There's been a power failure or you opened the dishwasher door

The wash cycle stops and then restarts when the electricity comes back on or when you close the door.

For your own safety, ensure the door is closed when the dishwasher is not in use.

Programme Chart









Select the most suitable programme for the type of dishes and how dirty they are. To select the wash programme see the chart below:

Salt, rinse aid, the right amount of detergent and the correct wash cycle...
This is the formula to get the best results and to keep your dishwasher in shape.

Note: In the 'Aquasensor' wash cycles, the cycles could undergo some modifications due to the intervention of the sensor which evaluates how dirty the dishes are and optimises the cycle in accordance.

'Aquasensor' wash cycles...

This means that your dishwasher is equipped with a sensor which evaluates how dirty your dishes are and allows these wash cycles to adjust automatically to provide you with a more efficient and economic wash cycle.

CYCLE	CYCLE SELECTION INSTRUCTIONS	CYCLE DESCRIPTION	DETERGENT FOR PRE-WASH & WASH	RINSE AID	WASH CYCLE DURATION (Tolerance $\pm 10\%$ without extra drying) in minutes
INTENSIVE 	Very dirty dishes and pans (NOT to be used for delicate items)	Pre-wash with hot water at 40°C Wash at 65°C 2 cold rinses Hot rinse at 65°C Drying	3+24 g	*	120
NORMAL 	Cycle for normally dirty pans and dishes. Standard daily cycle.	Wash at 60°C Cold rinse Hot rinse at 70°C Drying	27 g	*	93
ECO 	Environmentally friendly cycle, with low energy consumption levels, suitable for normally dirty pans and dishes.	2 cold pre-washes Wash at 50°C Hot rinse at 65°C Drying	3+24 g	*	145
FAST & DRY 	Economic and fast cycle to be used for slightly dirty dishes. Run cycle immediately after use.	Short wash at 47°C Hot rinse at 65°C Drying	20 g	*	40
PRE-WASH 	Preliminary wash cycle for dishes while awaiting completion of the load with the dishes from the next meal.	Short cold wash to prevent food from drying onto the dishes.			12
DELICATES 	Special cycle to be used for more delicate items which are sensitive to high temperatures. Run cycle immediately after use.	Wash at 52°C Rinse at 45°C Hot rinse at 65°C Drying	20 g	*	90
SPECIAL GUEST 	Rinse and drying cycle for dishes that are seldom used and are only dusty.	Hot rinse at 65°C Drying		*	36
OPTIONAL WASH CYCLE					
AUTO DUO WASH 	Wash differentiated on the two racks. Delicate for glassware and glasses on the upper rack and heavy duty for the pans on the lower rack.	Cold pre-wash Wash at 52°C Lukewarm rinse at 45°C Hot rinse at 65°C Drying	3+24 g	*	105

To optimise wash performance and save on energy, try to use the dishwasher with a full wash load. If it takes some time to fill your dishwasher, use the pre-wash to avoid caked on food and build up of bad odours.

Care and Cleaning

Unplug the appliance.

Before carrying out any cleaning or maintenance on the dishwasher, always remove the plug from the electricity socket.

After every wash.

When the wash cycle has ended, always remember to turn off the water supply tap and to leave the appliance door ajar. This way, moisture and bad odours will not be trapped inside.

The filter assembly

- If you want consistent good results from your dishwasher, you need to clean the filter assembly.
- Remove the larger food particles trapped inside the cup "C" and the semi-circular filter A after each wash; pull the cup handle upwards to remove them. Just rinse them under running water.
- The entire filter assembly should be cleaned thoroughly once a month: cup C + semi-circular filter A + cylindrical filter B. Rotate filter "B" anticlockwise to remove it. For cleaning, use a non metallic brush.

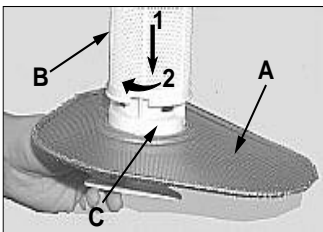

Reassemble the filter parts (as shown in the figure) and reinsert the whole assembly into the dishwasher. Position it into its housing and press downwards. The dishwasher is not to be used without filters. Improper replacement of the filters may reduce the efficiency of the wash and even damage your dishwasher.

Cleaning the spray arms.

Food residue may become encrusted onto the spray arms and block the holes where water comes out. Check the spray arms regularly and clean them once in a while.



The seals.

One of the factors that cause unpleasant odours to form inside the dishwasher is food that remains trapped in the seals. Periodic cleaning using a damp sponge will prevent this from occurring.

DO NOT use solvents or abrasives to clean the exterior and rubber parts of your appliance, do not use solvents or abrasive cleaning products. Use a cloth dampened with lukewarm soapy water only.

If there are any stains on the surface of the appliance interior, use a cloth dampened with water and a little white vinegar, or a cleaning product specifically made for dishwashers.

Going away

If the dishwasher is not going to be used for some time, carry out the following:

- run a cycle with the dishwasher empty.
- switch off at the electrical socket and unplug.
- turn off the water supply tap, disconnect the inlet hose and allow to drain.
- fill the rinse aid dispenser.
- leave the door ajar, to prevent the build up of unpleasant odours inside the dishwasher.

Before using the dishwasher after a long break, plug in and switch on at the electrical socket. Reconnect the inlet hose and turn on the water supply tap. Check there are no deposits of rust inside the water pipe, if there are allow water to run from the supply tap for a few minutes.

Disconnecting the dishwasher.

When disconnecting the dishwasher it is important that tasks are carried out in the correct sequence.

- switch off at the mains and remove the plug from the socket.
- turn off the water supply.
- disconnect drain and water inlet hose.
- pull out the dishwasher, carefully, withdrawing hoses at the same time.

Moving the appliance.

Drain water from the dishwasher. Secure all loose parts. Only transport in an upright position.

- If not kept upright during transport, any water remaining inside may seep into the control module and cause subsequent errors with programme functions.

Troubleshooting

Caution

- Do not forget that repairs should only be carried out by a qualified specialist. Improper repairs can lead to considerable equipment damage, as well as danger to the user.
- The dishwasher must first be disconnected from the electricity supply before any repairs or other work can be carried out. Switch off at the mains socket and water supply and remove the plug.

Resolving minor problems yourself.

Experience has shown that you can resolve most problems that arise during normal daily usage yourself, without having to call out a service engineer. Not only does this save costs but it also means the appliance is available for use again that much sooner. The following list of common occurrences and their remedies should help you identify the causes of most problems.

If the dishwasher won't start, check...

- Is the dishwasher plugged in at the electricity socket and switched on?
- Is there a power failure, check other appliances.
- Check the fuse.
- Is the water supply tap turned on?
- Is the water inlet hose connected properly?
- Is the pressure of the water supply sufficient?
- Is the inlet hose kinked?
- Is the filter on the water supply hose blocked?
- Is the dishwasher door not closed properly?

If water remains inside the dishwasher, check...

- the drain hose is not kinked.
- the drain syphon is not obstructed.
- the dishwasher filters are not clogged.

If the dishes are not being cleaned properly, check...

- the correct amount of detergent has been added.
- there is regenerating salt in the salt container.
- the dishes have been loaded correctly.
- the selected programme is suitable for the type of dishes and the degree of soiling.
- all filters are clean and positioned correctly.
- the spray arm nozzles are not obstructed.
- there is nothing obstructing the rotation of the spray arms.

If the dishes fail to dry or remain dirty, check...

- there is rinse aid inside the rinse aid container.
- the rinse aid dispenser setting is correct.
- the detergent being used is of good quality and has not lost its effectiveness (for example, through incorrect storage, with the box left open).

If the dishes show signs of streaking, staining etc. check...

- the rinse aid dispenser setting is not set too high.

If there are visible traces of rust inside the tank, check...

- the cap off the salt container is securely closed and that the water softener setting is correct.
- the correct amount of detergent is being used. Certain detergents can be more corrosive than others.
- the tank is made of steel and therefore any rust marks are due to external elements (fragments of rust from the tank pipes, pots, cutlery etc.) Special products are commercially available to remove such marks.

Error messages.

Your dishwasher is equipped with a safety system which is able to detect any operating anomalies. These anomalies or faults are signalled by several codes consisting of letters and numbers that flash up on the display. Make a note of the error code that appears, turn the appliance off, turn off the water tap and call for technical assistance.

Tap off alarm

If you have forgotten to turn on the water tap, your appliance will remind you with a long series of prolonged beeps and the wording **H2O** will flash up on the display. Turn the tap on and the wash cycle will start up after a few minutes.

If you are not there when this signal appears, the appliance will switch to alarm mode and the code "**AL06**" will flash on the display.

Turn the display off by keeping the Stand-by button  pressed, check that there is water in the mains supply and turn on the tap; turn the display back on by keeping the same button pressed again. Repeat the programming operations and start the dishwasher by pressing the START button.

Clogged filter alarm

If the appliance is blocked and the code "**AL05**" is flashing, this means the filter is clogged by large particles of food residue. Turn the display off by keeping the Stand-by button  pressed clean the filter thoroughly and reposition it in its seat as illustrated on page 14. Then turn it back on. Repeat the programming operations and start the dishwasher by pressing the START button

Water leak alarm

If this indicator light is flashing, this means the appliance is blocked due to a water leak. Turn off the water tap, cut off the electricity supply and call for technical assistance.

You have checked everything, but the dishwasher still doesn't work and the problem persists?

Call an authorised service centre near you and remember to mention:

- the type of malfunction
- the model mark (Mod. ...) and the serial number (S/N. ...) indicated on the rating plate located on the inner door, to one side.

INFORMATION FOR TEST LABS

Load for 9 Standard Settings tests (upper rack at lower position)

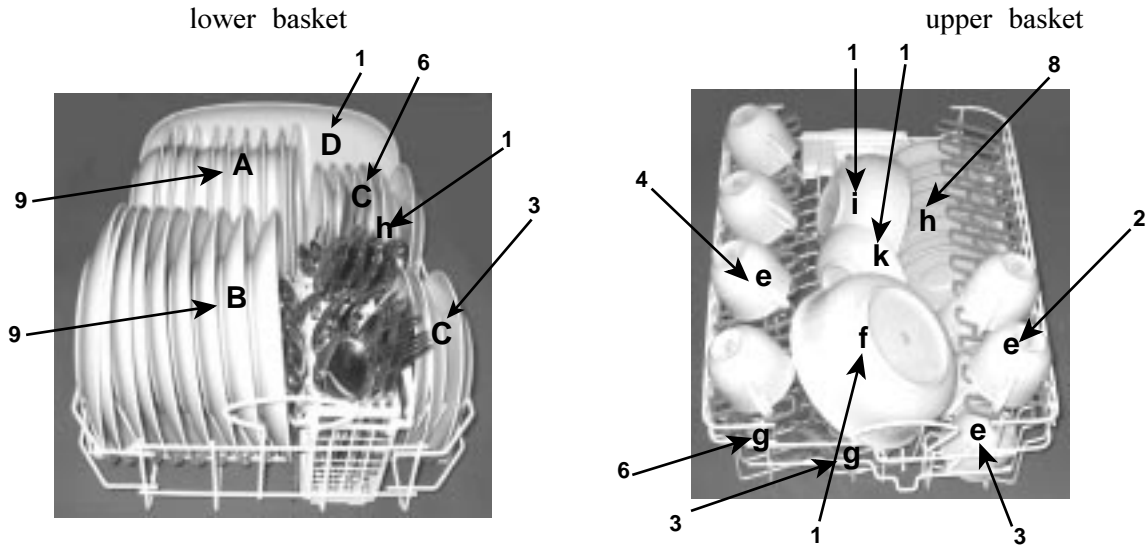

Lower basket			Upper basket		
Type	Item	Diameter Volum (approximately)	Type	Item	Diameter/Volum (approximately)
A	soupe plate	23 cm.	e	cup	0,20 l.
B	dinner plate	26 cm.	f	serving bowl	19 cm.
C	dessert plate	19 cm.	g	glass	250 ml.
D	oval platter	35 cm.	h	saucer	14 cm.
h	saucer	14 cm.	k	serving bowl	13 cm.
			i	serving bowl	16 cm.

Loading the detergent

The cleaning detergent should be introduced into the two containers "Comp.2" and "Comp.3 (see table at the end of the page).

Loading the Rinse Aid

The amount of rinse aid used for each cycle can be regulated by turning the dose adjuster 'F' which you will find under lid 'C'. There are 6 different settings; the normal dosage is setting 5.

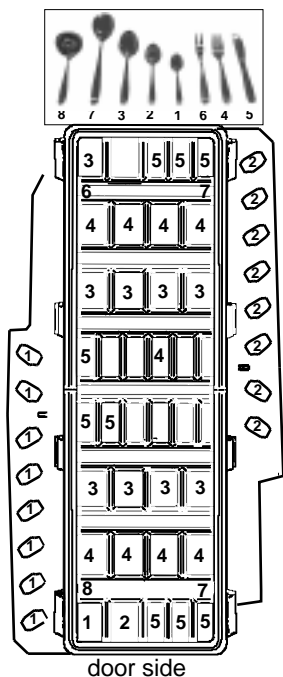

If the cutlery basket is equipped with two removable grids: insert the cutlery one by one into the slots, with the handles at the bottom. Position them so that they don't touch.

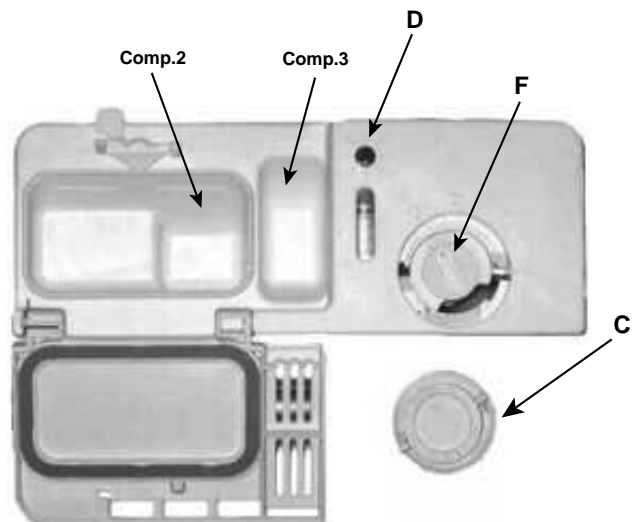

	Cycle	Total detergent	Comp.2	Comp.3
EN 50242	Eco	27 gr.	24	3
IEC/ DIN	Eco+extra dry *	27 gr.	27	

* Press the "extra dry" button, if existing.



After Sales Service

"No company is better positioned to offer an after sales service on a Hotpoint appliance than us - the manufacturer"

As part of our commitment to you, all Hotpoint appliances have the added benefit of a fully inclusive parts and labour guarantee for the first 12 months. In addition to this you also have the advantage of **free replacement parts for the first 5 years** when fitted by a Hotpoint engineer. When the 12 months parts and labour guarantee expires we offer the following after sales service options:

Repair Service and Information Help Desk

UK: 08709 066066

www.theservicecentre.co.uk

Republic of Ireland: 1850 302 200

Note: Our operators will require the Model number and the Serial number of your appliance

Available 364 days a year with a fast, effective and value for money service. We have the largest white goods repair service in the UK with over 900 of our own fully trained engineers. All repairs include a parts and labour guarantee for 12 months from the date of the repair.

If you require any information or have any questions about your appliance, our operators are on hand with help and advice.

All this ensures that you will receive the best available after sales service possible.

Extended Warranties

UK: 08709 088 088

www.theservicecentre.co.uk

Republic of Ireland: 1850 502 200

Whether you have just one or a number of Hotpoint appliances in your kitchen, we offer two service cover plans to give you total peace of mind.

- Repair Protection Plan - FREE service repairs for a single Hotpoint appliance during the period of cover.
- Kitchen Cover - FREE service repairs for all your Hotpoint appliances less than 8 years old.

Genuine Parts and Accessories

UK: 08709 077 077

www.theservicecentre.co.uk

Republic of Ireland: (01) 842 6836

A wide range of genuine parts and accessories are available from our hotline or through our web site.

Genuine parts and accessories, extended warranties and service repairs are all available on our web-site at:





Guarantee

"Satisfaction guaranteed or your money back"

We give you a unique 'satisfaction guaranteed' promise - **valid for 90 days** - after you have purchased your Hotpoint appliance. If there is a technical problem simply call Hotpoint Repair service or visit our web-site at www.theservicecentre.co.uk and where necessary, we will arrange for an engineer to call. If the technical problem is not resolved under this guarantee, **we will replace your machine or, if you prefer, give you your money back.**

All Hotpoint appliances carry a fully inclusive 12 month parts and labour guarantee as well as free replacement parts for the first 5 years (except microwaves, selected integrated appliances and cooker hoods, which have a one year guarantee) provided that they are fitted by a Hotpoint engineer.

Guarantee terms and conditions

Your guarantee is only applicable in the United Kingdom or Republic of Ireland and is subject to the following provisions that your appliance:

- Has been installed and used correctly in accordance with this instruction booklet.
- Has been used solely for domestic purposes and is located on domestic premises (ie. not for commercial or trade use).
- Has been properly connected to a suitable electrical supply voltage as stated on the appliance rating plate.
- Has not been subject to misuse, accident, modified or repaired by anyone other than one of our own service engineers.



For pre purchase information on any other Hotpoint product call: 08701 50 60 70
or visit: www.hotpoint.co.uk



Recycling & Disposal Information

As part of Hotpoint's continued commitment to helping the environment, Hotpoint reserves the right to use quality recycled components to keep down customer costs and minimise material wastage. Please dispose of packaging and old appliances carefully.

To minimise risk of injury to children, remove the door, plug and cut mains cable off flush with the appliance. Dispose of these parts separately to ensure that the appliance can no longer be plugged into a mains socket and the door cannot be locked shut.



Key Contacts

After Sales Service

Over 900 trained specialists, directly employed by us, ensure that you can have complete confidence in both the appliances and services we offer.



Repair Service and Information Desk

UK: 08709 066 066

(Open 8 to 8 Mon - Fri, 8 to 6 Sat, 10 to 4 Sun & Bank Holidays)

www.theservicecentre.co.uk

Republic of Ireland: 1850 302 200

Note: Our operators will require the following information:

Model number:

Serial number:

Extended Warranties

UK: 08709 088 088

(Open 8 to 8 Mon - Sun)

www.theservicecentre.co.uk

Republic of Ireland: 1850 502 200

Genuine Parts and Accessories

UK: 08709 077 077

(Open 8-30 to 5-30 Mon - Fri & 9 to 12 Sat)

www.theservicecentre.co.uk

Republic of Ireland: (01) 842 6836

Merloni Elettrodomestici UK Ltd. Morley Way, Peterborough, PE2 9JB