

User's Manual



VTG 300/300R
Video Test Generator with Audio



www.extron.com

Extron Electronics, USA
1230 South Lewis Street
Anaheim, CA 92805
USA
714.491.1500
Fax 714.491.1517

Extron Electronics, Europe
Beeldschermweg 6C
3821 AH Amersfoort
The Netherlands
+31.33.453.4040
Fax +31.33.453.4050

Extron Electronics, Asia
135 Joo Seng Road, #04-01
PM Industrial Building
Singapore 368363
+65.6383.4400
Fax +65.6383.4664

Extron Electronics, Japan
Kyodo Building
16 Ichibancho
Chiyoda-ku, Tokyo 102-0082 Japan
+81.3.3511.7655
Fax +81.3.3511.7656

68-737-01 Rev. D
06 06

Precautions

Safety Instructions • English

 This symbol is intended to alert the user of important operating and maintenance (servicing) instructions in the literature provided with the equipment.



This symbol is intended to alert the user of the presence of uninsulated dangerous voltage within the product's enclosure that may present a risk of electric shock.

Caution

Read Instructions • Read and understand all safety and operating instructions before using the equipment.

Retain Instructions • The safety instructions should be kept for future reference.

Follow Warnings • Follow all warnings and instructions marked on the equipment or in the user information.

Consignes de Sécurité • Français

 Ce symbole sert à avertir l'utilisateur que la documentation fournie avec le matériel contient des instructions importantes concernant l'exploitation et la maintenance (réparation).



Ce symbole sert à avertir l'utilisateur de la présence dans le boîtier de l'appareil de tensions dangereuses non isolées posant des risques d'électrocution.

Attention

Lire les instructions • Prendre connaissance de toutes les consignes de sécurité et d'exploitation avant d'utiliser le matériel.

Conservier les instructions • Ranger les consignes de sécurité afin de pouvoir les consulter à l'avenir.

Respecter les avertissements • Observer tous les avertissements et consignes marqués sur le matériel ou présentés dans la documentation utilisateur.

Sicherheitsanleitungen • Deutsch



Dieses Symbol soll dem Benutzer in der im Lieferumfang enthaltenen Dokumentation besonders wichtige Hinweise zur Bedienung und Wartung (Instandhaltung) geben.



Dieses Symbol soll den Benutzer darauf aufmerksam machen, daß im Inneren des Gehäuses dieses Produktes gefährliche Spannungen, die nicht isoliert sind und die einen elektrischen Schock verursachen können, herrschen.

Achtung

Lesen der Anleitungen • Bevor Sie das Gerät zum ersten Mal verwenden, sollten Sie alle Sicherheits- und Bedienungsanleitungen genau durchlesen und verstehen.

Aufbewahren der Anleitungen • Die Hinweise zur elektrischen Sicherheit des Produktes sollten Sie aufbewahren, damit Sie im Bedarfsfall darauf zurückgreifen können.

Befolgen der Warnhinweise • Befolgen Sie alle Warnhinweise und Anleitungen auf dem Gerät oder in der Benutzerdokumentation.

Instrucciones de seguridad • Español



Este símbolo se utiliza para advertir al usuario sobre instrucciones importantes de operación y mantenimiento (o cambio de partes) que se desean destacar en el contenido de la documentación suministrada con los equipos.



Este símbolo se utiliza para advertir al usuario sobre la presencia de elementos con voltaje peligroso sin protección aislante, que puedan encontrarse dentro de la caja o alojamiento del producto, y que puedan representar riesgo de electrocución.

Precaucion

Leer las instrucciones • Leer y analizar todas las instrucciones de operación y seguridad, antes de usar el equipo.

Conservar las instrucciones • Conservar las instrucciones de seguridad para futura consulta.

Obedecer las advertencias • Todas las advertencias e instrucciones marcadas en el equipo o en la documentación del usuario, deben ser obedecidas.

Avoid Attachments • Do not use tools or attachments that are not recommended by the equipment manufacturer because they may be hazardous.

Warning

Power sources • This equipment should be operated only from the power source indicated on the product. This equipment is intended to be used with a main power system with a grounded (neutral) conductor. The third (grounding) pin is a safety feature, do not attempt to bypass or disable it.

Power disconnection • To remove power from the equipment safely, remove all power cords from the rear of the equipment, or the desktop power module (if detachable), or from the power source receptacle (wall plug).

Power cord protection • Power cords should be routed so that they are not likely to be stepped on or pinched by items placed upon or against them.

Servicing • Refer all servicing to qualified service personnel. There are no user-serviceable parts inside. To prevent the risk of shock, do not attempt to service this equipment yourself because opening or removing covers may expose you to dangerous voltage or other hazards.

Slots and openings • If the equipment has slots or holes in the enclosure, these are provided to prevent overheating of sensitive components inside. These openings must never be blocked by other objects.

Lithium battery • There is a danger of explosion if battery is incorrectly replaced. Replace it only with the same or equivalent type recommended by the manufacturer. Dispose of used batteries according to the manufacturer's instructions.

Eviter les pièces de fixation • Ne pas utiliser de pièces de fixation ni d'outils non recommandés par le fabricant du matériel car cela risquerait de poser certains dangers.

Avertissement

Alimentations • Ne faire fonctionner ce matériel qu'avec la source d'alimentation indiquée sur l'appareil. Ce matériel doit être utilisé avec une alimentation principale comportant un fil de terre (neutre). Le troisième contact (de mise à la terre) constitue un dispositif de sécurité: n'essayez pas de la contourner ni la désactiver.

Déconnexion de l'alimentation • Pour mettre le matériel hors tension sans danger, déconnectez tous les cordons d'alimentation de l'arrière de l'appareil ou du module d'alimentation de bureau (s'il est amovible) ou encore de la prise secteur.

Protection du cordon d'alimentation • Acheminer les cordons d'alimentation de manière à ce que personne ne risque de marcher dessus et à ce qu'ils ne soient pas écrasés ou pincés par des objets.

Réparation-maintenance • Faire exécuter toutes les interventions de réparation-maintenance par un technicien qualifié. Aucun des éléments internes ne peut être réparé par l'utilisateur. Afin d'éviter tout danger d'électrocution, l'utilisateur ne doit pas essayer de procéder lui-même à ces opérations car l'ouverture ou le retrait des couvercles risquent de l'exposer à de hautes tensions et autres dangers.

Fentes et orifices • Si le boîtier de l'appareil comporte des fentes ou des orifices, ceux-ci servent à empêcher les composants internes sensibles de surchauffer. Ces ouvertures ne doivent jamais être bloquées par des objets.

Lithium Batterie • Il a danger d'explosion s'il y a remplacement incorrect de la batterie. Remplacer uniquement avec une batterie du même type ou d'un type équivalent recommandé par le constructeur. Mettre au reut les batteries usagées conformément aux instructions du fabricant.

Keine Zusatzgeräte • Verwenden Sie keine Werkzeuge oder Zusatzgeräte, die nicht ausdrücklich vom Hersteller empfohlen wurden, da diese eine Gefahrenquelle darstellen können.

Vorsicht

Stromquellen • Dieses Gerät sollte nur über die auf dem Produkt angegebene Stromquelle betrieben werden. Dieses Gerät wurde für eine Verwendung mit einer Hauptstromleitung mit einem geerdeten (neutralen) Leiter konzipiert. Der dritte Kontakt ist für einen Erdschluß, und stellt eine Sicherheitsfunktion dar. Diese sollte nicht umgangen oder außer Betrieb gesetzt werden.

Stromunterbrechung • Um das Gerät auf sichere Weise vom Netz zu trennen, sollten Sie alle Netzabel aus der Rückseite des Gerätes, aus der externen Stromversorgung (falls dies möglich ist) oder aus der Wandsteckdose ziehen.

Schutz des Netzkabels • Netzkabel sollten stets so verlegt werden, daß sie nicht im Weg liegen und niemand darauf treten kann oder Objekte darauf oder unmittelbar dagegen gestellt werden können.

Wartung • Alle Wartungsmaßnahmen sollten nur von qualifiziertem Servicepersonal durchgeführt werden. Die internen Komponenten des Gerätes sind wartungsfrei. Zur Vermeidung eines elektrischen Schocks versuchen Sie in keinem Fall, dieses Gerät selbst öffnen, da beim Entfernen der Abdeckungen die Gefahr eines elektrischen Schlags und/oder andere Gefahren bestehen.

Schlitzte und Öffnungen • Wenn das Gerät Schlitzte oder Löcher im Gehäuse aufweist, dienen diese zur Vermeidung einer Überhitzung der empfindlichen Teile im Inneren. Diese Öffnungen dürfen niemals von anderen Objekten blockiert werden.

Litium-Batterie • Explosionsgefahr, falls die Batterie nicht richtig ersetzt wird. Ersetzen Sie verbrauchte Batterien nur durch den gleichen oder einen vergleichbaren Batterytyp, der auch vom Hersteller empfohlen wird. Entsorgen Sie verbrauchte Batterien bitte gemäß den Herstelleranweisungen.

Evitar el uso de accesorios • No usar herramientas o accesorios que no sean específicamente recomendados por el fabricante, ya que podrían implicar riesgos.

Advertencia

Alimentación eléctrica • Este equipo debe conectarse únicamente a la fuente/tipo de alimentación eléctrica indicada en el mismo. La alimentación eléctrica indicada en el mismo proviene de un sistema de distribución general con conductor neutro a tierra. La tercera pata (puesta a tierra) es una medida de seguridad, no puentearla ni eliminarla.

Desconexión de alimentación eléctrica • Para desconectar con seguridad la acometida de alimentación eléctrica al equipo, desenchufar todos los cables de alimentación en el panel trasero del equipo, o desenchufar el módulo de alimentación (si fuera independiente), o desenchufar el cable del receptáculo de la pared.

Protección del cables de alimentación • Los cables de alimentación eléctrica se deben instalar en lugares donde no sean pisados ni apretados por objetos que se puedan apoyar sobre ellos.

Reparaciones/mantenimiento • Solicitar siempre los servicios técnicos de personal calificado. En el interior no hay partes a las que el usuario deba acceder. Para evitar riesgo de electrocución, no intentar personalmente la reparación/mantenimiento de este equipo, ya que al abrir o extraer las tapas puede quedar expuesto a voltajes peligrosos u otros riesgos.

Ranuras y aberturas • Si el equipo posee ranuras o orificios en su caja/alojamiento, es para evitar el sobrecalentamiento de componentes internos sensibles. Estas aberturas nunca se deben obstruir con otros objetos.

Batería de litio • Existe riesgo de explosión si esta batería se coloca en la posición incorrecta. Cambiar esta batería únicamente con el mismo tipo (o su equivalente) recomendado por el fabricante. Desachar las baterías usadas siguiendo las instrucciones del fabricante.

FCC Class A Notice

Note: This equipment has been tested and found to comply with the limits for a Class A digital device, pursuant to part 15 of the FCC Rules. These limits are designed to provide reasonable protection against harmful interference when the equipment is operated in a commercial environment. This equipment generates, uses and can radiate radio frequency energy and, if not installed and used in accordance with the instruction manual, may cause harmful interference to radio communications. Operation of this equipment in a residential area is likely to cause harmful interference, in which case the user will be required to correct the interference at his own expense.

Note: This unit was tested with shielded cables on the peripheral devices. Shielded cables must be used with the unit to ensure compliance.

Extron's Warranty

Extron Electronics warrants this product against defects in materials and workmanship for a period of three years from the date of purchase. In the event of malfunction during the warranty period attributable directly to faulty workmanship and/or materials, Extron Electronics will, at its option, repair or replace said products or components, to whatever extent it shall deem necessary to restore said product to proper operating condition, provided that it is returned within the warranty period, with proof of purchase and description of malfunction to:

USA, Canada, South America, and Central America:

Extron Electronics
1001 East Ball Road
Anaheim, CA 92805, USA

Asia:

Extron Electronics, Asia
135 Joo Seng Road, #04-01
PM Industrial Bldg.
Singapore 368363

Europe, Africa, and the Middle East:

Extron Electronics, Europe
Beeldschermweg 6C
3821 AH Amersfoort
The Netherlands

Japan:

Extron Electronics, Japan
Kyodo Building
16 Ichibancho
Chiyoda-ku, Tokyo 102-0082
Japan

This Limited Warranty does not apply if the fault has been caused by misuse, improper handling care, electrical or mechanical abuse, abnormal operating conditions or non-Extron authorized modification to the product.

If it has been determined that the product is defective, please call Extron and ask for an Applications Engineer at (714) 491-1500 (USA), 31.33.453.4040 (Europe), 65.6383.4400 (Asia), or 81.3.3511.7655 (Japan) to receive an RA# (Return Authorization number). This will begin the repair process as quickly as possible.

Units must be returned insured, with shipping charges prepaid. If not insured, you assume the risk of loss or damage during shipment. Returned units must include the serial number and a description of the problem, as well as the name of the person to contact in case there are any questions.

Extron Electronics makes no further warranties either expressed or implied with respect to the product and its quality, performance, merchantability, or fitness for any particular use. In no event will Extron Electronics be liable for direct, indirect, or consequential damages resulting from any defect in this product even if Extron Electronics has been advised of such damage.

Please note that laws vary from state to state and country to country, and that some provisions of this warranty may not apply to you.

安全须知 • 中文



这个符号提示用户该设备用户手册中有重要的操作和维护说明。



这个符号警告用户该设备机壳内有露的危险电压，有触电危险。

注意

- 阅读说明书
- 保存说明书
- 遵守警告
- 避免追加

警告

- 电源
- 拔掉电源
- 电源线保护
- 维护
- 通风孔
- 锂电池

Quick Start Guide — VTG 300/300R

CAUTION Operation and service must be performed by authorized personnel only. These units must be operated in accordance with national and local electrical codes.

NOTE Prior to using the VTG 300R for the first time, please be sure that the batteries are fully charged.

To operate the VTG 300/300R, follow these steps and see chapter 2.

Step 1

Connect a video device to one of the top panel connectors or connect an audio device to one of the bottom panel connectors.

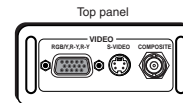

The video connectors located on the top panel will accommodate RGB, component, S-video, and composite video output.

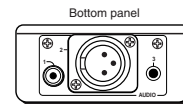

The audio connectors located on the bottom panel will accommodate unbalanced mono audio on the RCA jack, balanced mono audio on the 3-pin XLR connector, and unbalanced mono audio (both left and right channels) on the 3.5 mm mini jack.

Step 2

Power up the VTG 300/300R.

Using either the external power supply or internal batteries, hold down the **Power** button ⑦ for one second.

Step 3

If generating an audio signal, press the audio **Signal** button ② to select an audio signal, as indicated by the lit LED. Press the audio **Level** buttons ③ to adjust the RMS signal level.

NOTE See the Audio Setup menu section in chapter 2 to specify either dBu or dBV as the signal level unit.

When the signal type is either a sine or square wave, press the **Frequency** buttons ④ to adjust the frequency from 20 Hz to 20 kHz (sine) or 20 Hz to 5 kHz (square).

When the signal type is frequency sweep, press the **Frequency** buttons ④ to adjust the sweep interval from 1.5 sec to 150 sec.

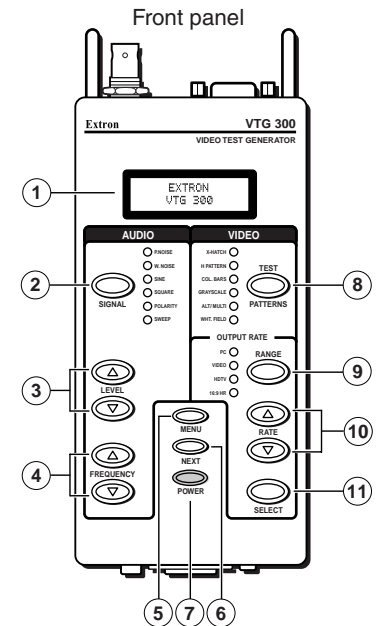

Quick Start Guide — VTG 300/300R, cont'd

Step 4

If generating a video signal, press the **Test Patterns** button (8) to select a test pattern type, as indicated by the lit LED. See *Selecting a Video Test Pattern* in chapter 2.

Press the **Range** button (9) to select from among the four video range types, as indicated by the lit LED.

Press the **Rate** buttons (10) to select from among the scan rates for the selected range, then press the **Select** button (11) to activate the selection.

Menu System

Use the **Menu** button (5) to advance through the main menus.

Use the **Next** button (6) to navigate through the submenu system. See the *Menus, Configuration, and Adjustments* section in chapter 2.

Grayscale or white field: To select a grayscale or white field test pattern, select the **Test Pattern Setup** main menu, then go to the the **Grayscale** submenu or the **White Field** submenu and press any ▲ or ▼ button to make a selection. The grayscale choices are 32-level split and ramp. The white field choices are full field, 80% window, and 20% window.

To select the audio level unit **dBV** or **dBu**: Select the **Audio units** submenu from the **Audio setup** main menu, then press any ▲ or ▼ button to make a selection.

To select **RGB** or **Y, B-Y, R-Y**: Select the **HD15 Video format** submenu from the **Video Setup** main menu, then press any ▲ or ▼ button to make a selection.

Enable@Power Up feature: Select which outputs (audio or video) are enabled when the VTG is turned on. This feature is only available when the unit is disconnected from AC power. Select the **Enable@PwrUp** submenu from the **Advanced Setup** main menu, then press any ▲ or ▼ button to make a selection.

Button Lock mode: Press the **Signal** (2) and **Test Patterns** (8) buttons simultaneously for 2 seconds to enable/disable front panel buttons.

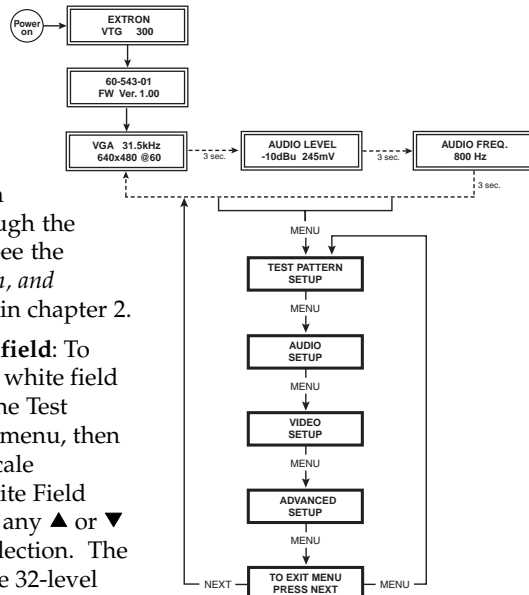

Table of Contents

Chapter 1 • Introduction	1-1
About the VTG 300/300R	1-2
Features	1-2
Chapter 2 • Operation	2-1
Front Panel Features	2-2
Left Side Panel LED (VTG 300R model only)	2-4
Right Side Panel Power Input	2-4
Top Panel Video Output	2-4
Bottom Panel Audio Output	2-4
Example Applications	2-5
Connecting Audio Outputs	2-5
Output 1	2-5
Output 2	2-6
Output 3	2-6
Menus, Configuration, and Adjustments	2-6
Moving through menus by using front panel controls	2-6
Default menu	2-7
Main menus	2-8
Test Pattern Setup menu	2-8
Grayscale submenu	2-9
White field submenu	2-9
Audio Setup menu	2-9
Audio units submenu (Units)	2-9
Output 3 submenu	2-10
Video Setup menu	2-10
HD15 Video format submenu (HD15 Format)	2-10
RGB Sync format submenu (RGB Sync Fmt)	2-11
Raster border submenu (RasterBorder)	2-11
Advanced Setup menu	2-11
Power off timer submenu (PwrOff Timer)	2-11
Screen saver timer submenu (ScrSvr Timer)	2-12
Screen saver mode submenu (ScrSvr Mode)	2-12
Enable at power up submenu (Enable@PwrUp)	2-13
Backlight submenu (BackLight)	2-13
Unit Reset submenu (Press & Hold)	2-14
Exit menu	2-14
Additional Functions	2-15
Low Battery mode	2-15

Table of Contents, cont'd



About the VTG 300/300R

The Extron VTG 300/300R is a portable, hand-held video and audio test generator. The VTG 300R features an integrated battery pack and charger, otherwise both models offer the same functions and features. Both models are herein referred to as the “VTG” throughout this manual. Also, “VTG” and “video test generator” will be used interchangeably.

The VTG will generate video signals for computer, standard resolution video, HDTV, and 16:9 high resolution output rates. The composite video format conforms to the SMPTE 170M video standard. There are also six test pattern categories available for optimizing the display output: crosshatch, H pattern, color bars, grayscale, alternating pixels/multiburst, and white field.

For audio signals, the VTG offers basic audio test signals including sine and square waves, pink noise, white noise, polarity testing, and a frequency sweep from 20 Hz to 20 kHz.

Video output connectors include BNC, 4-pin mini DIN, and 15-pin HD connectors. Audio output is provided through RCA, 3-pin XLR, and 3.5 mm phone jack connectors.

The VTG 300 is powered by the included external power supply or four AA-type batteries (not included). The VTG 300R is powered by both the included external power supply and the built-in rechargeable batteries.

Features

Multiple video outputs — Video output rates include:

- computer video (RGB)
- standard definition video (NTSC/PAL) – composite, S-video, component video, or RGB
- HDTV (component, RGB)
- 16:9 high resolution (RGB)

Scan rates and test patterns — The VTG outputs 37 different scan rates and offers thirteen different test patterns in six categories.

Multiple audio outputs — Audio output is provided through RCA, 3-pin XLR, and 3.5 mm phone jack connectors.

Automatic recall — Whenever the VTG is powered down, the most recent settings are saved and then recalled when the unit is powered back up.

Protective boot — To help protect the VTG from physical damage, a special protective rubber boot is included.



Chapter Two

Operation

Front Panel Features

Left Side Panel LED (VTG 300R model only)

Right Side Panel Power Input

Top Panel Video Output

Bottom Panel Audio Output

Example Applications

Connecting Audio Outputs

Menus, Configuration, and Adjustments

Additional Functions

Audio Testing Features

Video Testing Features

Installing the VTG 300 Batteries

Conserving the VTG 300 Battery Life

Recharging the VTG 300R

Installing the Protective Boot

Front Panel Features

- ① **LCD** — A two-row liquid crystal display for viewing the VTG status, menus, and options.
- ② **Audio signal type (Signal)** — Press this button to select from among six different audio signals, as indicated by green LEDs to the right: pink noise (P. Noise), white noise (W. Noise), sine wave (Sine), square wave (Square), polarity test (Polarity), and swept sine wave (Sweep).

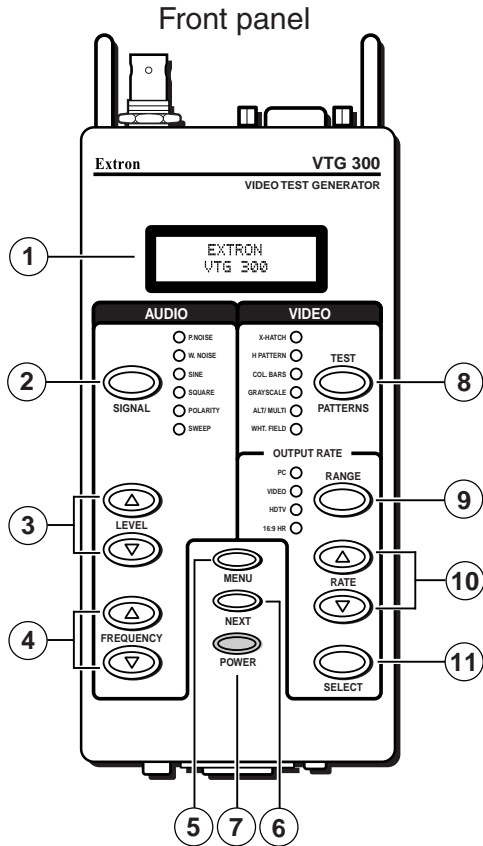

- ③ **Audio output signal level adjustment (Level)** — Press the ▲ button to increase the RMS signal level and the ▼ button to decrease the RMS signal level. See the *Audio Setup menu* section in this chapter to specify either dBu or dBV as the signal level unit.

The audio output level settings for all audio signal types (see ② above) are retained after the VTG is powered off. The default setting is -28 dBu for polarity and -10 dBu for all other signal types.

NOTE *If the Level buttons are held down for more than one second, the VTG will automatically increment the level adjustment in the direction indicated by the button.*

- ④ **Audio frequency adjustment (Frequency)** — When the audio signal type is either a sine or square wave (see ② above), the audio frequency can be adjusted from 20 Hz to 20 kHz (sine) or 20 Hz to 5 kHz (square). Press the ▲ button to increase the frequency and the ▼ button to decrease the frequency. The adjustment is in 1/3 octave steps. See *Setting the Audio Frequency* in this chapter.
- ⑤ **Menu selection (Menu)** — Press the Menu button to advance through the four main menus. See the *Menus, Configuration, and Adjustments* section in this chapter.
- ⑥ **Next** — Press the Next button to step through the submenus. See the *Menus, Configuration, and Adjustments* section in this chapter.
- ⑦ **Power** — Power up or power down the VTG 300 by holding down the Power button for one second.

NOTE *If the Power button is held down for more than three seconds, the VTG will automatically turn off. This feature will prevent the VTG from being left on unintentionally should the power button be unknowingly pressed.*

- ⑧ **Video test patterns (Test Patterns)** — Press this button to select from among 13 different test patterns in six categories, as indicated by green LEDs to the left of each category: crosshatch (X-hatch), H pattern, color bars (Col. Bars), grayscale, alternating pixels/multiburst (Alt./Multi), or white field (Wht. Field). See *Selecting a Video Test Pattern* in this chapter.
- ⑨ **Video output range (Range)** — Select the video output signal range, as indicated by green LEDs to the left: computer scan rates (PC), video scan rates (Video), HDTV scan rates (HDTV), or 16:9 HR scan rates.
- ⑩ **Video output rate adjustment (Rate)** — Press the ▲ button or ▼ button to vary the scan rate for a selected output range.
- ⑪ **Select video output rate (Select)** — Select and activate the desired output rate for a given range by pressing this button.

Left Side Panel LED (VTG 300R model only)

- 1 **Battery charge status LED** — The amber LED lights steadily when the VTG is being charged, and blinks steadily when the the VTG is fully charged.

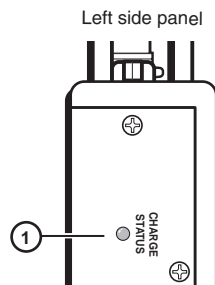

Right Side Panel Power Input

- 1 **12 VDC power input** — The included external 12 VDC, 100 VAC to 240 VAC, 50/60 Hz power supply plugs into this connector located on the right side panel.

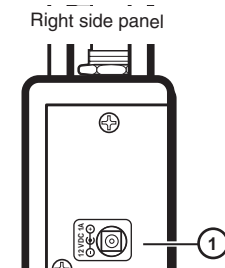

Top Panel Video Output

- 1 **RGB/R-Y, Y, B-Y output** — RGBHV, RGBS, RGsB, RsGsBs, and component video are output through the 15-pin HD connector.

NOTE For NTSC/PAL rates, the component video output is intended for signal verification and alignment, and should not be used as a reference.

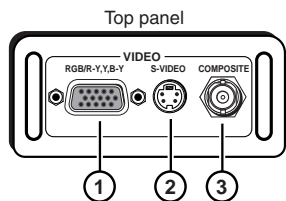

- 2 **S-video output** — S-video is output through the 4-pin mini DIN connector.
- 3 **Composite video output** — Composite video is output through the BNC connector.

Bottom Panel Audio Output

- 1 **Output 1: RCA jack** — Unbalanced mono audio is output from this female jack.

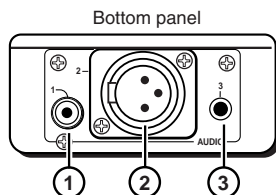

- 2 **Output 2: 3-pin XLR connector** — Balanced mono audio is output from this male connector.
- 3 **Output 3: 3.5 mm mini stereo phone jack** — Unbalanced mono audio on both left and right channels is output from this female mini phone jack.

NOTE See Connecting Audio Outputs in this chapter for audio wiring instructions.

Example Applications

The following illustrations are examples of using the video and audio testing features of the VTG.

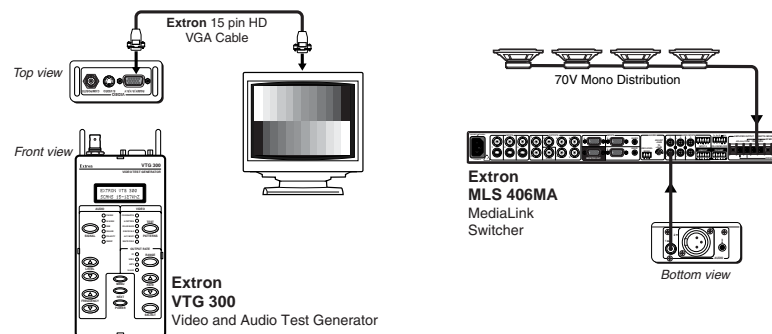

Connecting Audio Outputs

The VTG has three types of audio output connectors: an RCA jack, a 3-pin XLR connector, and a 3.5 mm mini stereo phone jack.

Output 1

Unbalanced mono audio is output from this connector. Wire the RCA connector as shown here.

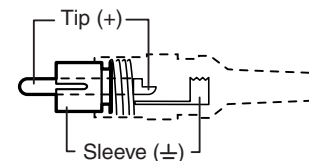

Output 2

Balanced mono audio is output from this connector. Wire the female XLR connector as shown here.



3-pin XLR Pin Configuration			
Application	Pin 1	Pin 2	Pin 3
Balanced audio (std.)	gnd (shield) (on sending/ female connector)	positive (+) (hot/live)	negative (-) (cold/return)

Output 3

Unbalanced mono audio on both left and right channels is output from this connector. Wire the mini phono plug as shown here. See the *Output 3 submenu* section in this chapter.

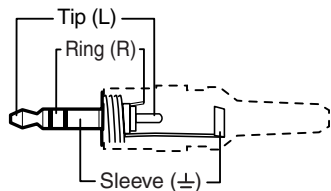

Menus, Configuration, and Adjustments

VTG configuration and adjustments are performed by using the front panel controls and the menus that are displayed on the LCD screen.

Moving through menus by using front panel controls

Menu button — Press the Menu button to step through the main menus. After 20 seconds of inactivity, the VTG will time-out and return to the default menu cycle.

Next button — Press the Next button to move between the submenus of a selected main menu.

Up (▲) and Down (▼) buttons — Use any of these buttons (Level, Frequency, or Rate), to increase (▲) or decrease (▼) submenu values, or to alternate between submenu options. Refer to the flowcharts in this chapter and to specific sections for explanations on submenu adjustments.

Default menu

The default menus appear on the LCD when no adjustments are actively being made. They cycle between the screens showing the currently selected horizontal scan frequency of the video output signal, the audio output level, and the audio frequency, as shown below.

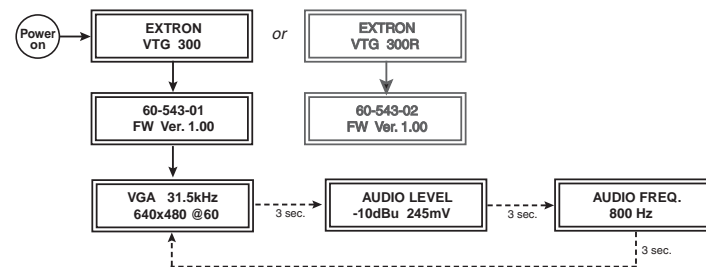

Figure 2-1 — Default menu cycle

NOTE From any menu or submenu, after 20 seconds of inactivity the VTG will save all adjustment settings and time out to the default menus.

NOTE A different default menu is displayed when the screen saver option is active. See Screen saver timer submenu (ScrSvr Timer) in this chapter.

NOTE If an output was disabled at power up, the menu will display "Audio disabled" or "Video disabled" instead of the normal menu. See Enable at power up submenu (Enable@PwrUp) in this chapter.

Main menus

The main menus are as shown in the following flowchart. Use the Menu button to step between main menus.

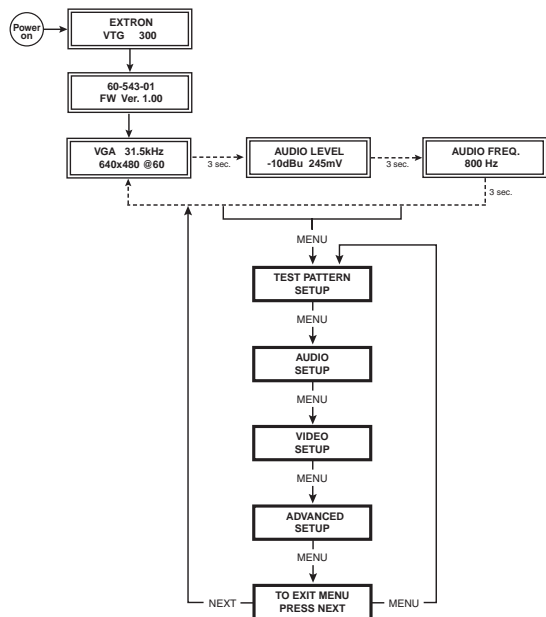

Figure 2-2 — Main menus for the VTG 300/300R

NOTE If you press the Menu button while a submenu is active, the next main menu will become active.

NOTE To return to the default menu cycle, let the VTG timeout for 20 seconds, or press the Menu button until the Exit Menu menu appears, then press the Next button.

Test Pattern Setup menu

The following flowchart illustrates the Test Pattern Setup menu.

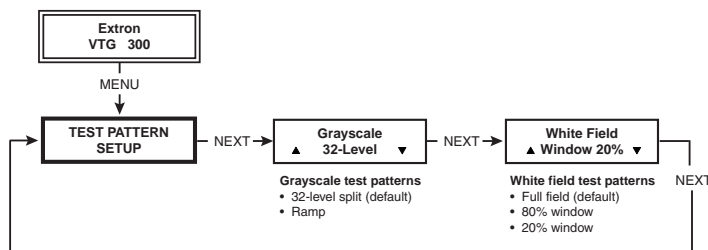

Figure 2-3 — Test Pattern Setup menu

Grayscale submenu

Select the grayscale test pattern from among two types.

Press any ▲ or ▼ button to select from the different test patterns:

- 32-level split bars (default) — to set grayscale tracking and evaluate contrast linearity.
- Ramp — to evaluate pixel bit depth capability.

White field submenu

There are three types of white field test patterns.

Press any ▲ or ▼ button to select the test pattern:

- Full field (default) — evaluate white field and color uniformity.
- 80% window — fine tune color balance and gain (drive) for each of the red, green, and/or blue color adjustments.
- 20% window — fine tune color balance and bias (offset) for each of the red, green, and/or blue color adjustments.

Audio Setup menu

The following flowchart illustrates the Audio Setup menu.

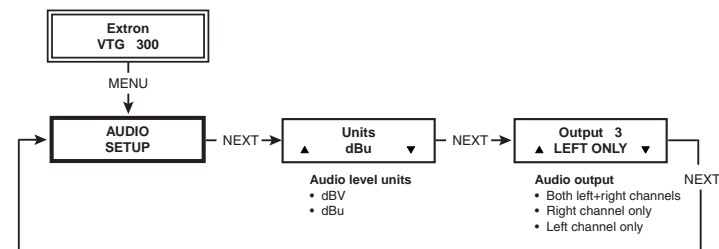

Figure 2-4 — Audio Setup menu

Audio units submenu (Units)

The audio level scale is selectable.

Press any ▲ or ▼ button to select from the different audio level units:

- dBV
- dBu (default)

Output 3 submenu

Output 3 may be set to output audio through the left and/or right channel(s).

Press any ▲ or ▼ button to select the audio output from Output 3's phono jack:

- Left and right channel (default) — output audio from both left and right channels of Output 3.
- Right only — output audio from the right channel and disable the left channel, and disable Output 1 (RCA) and Output 2 (XLR).
- Left only — output audio from left channel only and disable the right channel.

Video Setup menu

The following flowchart provides an overview of the Video Setup menu.

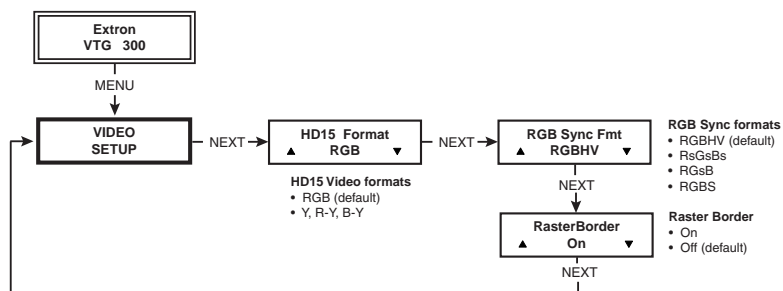

Figure 2-5 — Video Setup menu

HD15 Video format submenu (HD15 Format)

There are two video formats that can be output from the 15-pin HD connector.

Press any ▲ or ▼ button to select from among the formats:

- RGB (default)
- Y, R-Y, B-Y

RGB Sync format submenu (RGB Sync Fmt)

The VTG offers a choice of four RGB sync formats. Press any ▲ or ▼ button to select from among the formats:

- RGBHV (default)
- RGBS
- RGSB
- RsGsBs

Raster border submenu (RasterBorder)

A white border may be placed around the active area of a video signal. Press any ▲ or ▼ button to enable (On) or disable (Off) the border:

- On
- Off (default)

Advanced Setup menu

The following flowchart provides an overview of the Advanced Setup menu.

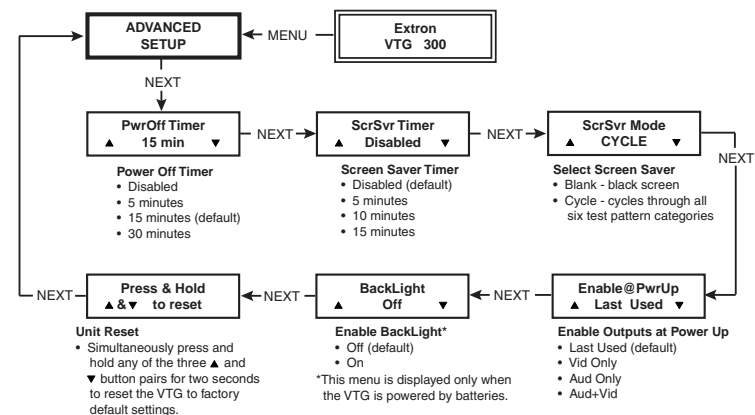

Figure 2-6 — Advanced Setup menu

Power off timer submenu (PwrOff Timer)

When enabled, this feature allows the VTG to be automatically powered off after a certain period of button inactivity has elapsed. This power off feature conserves battery power.

NOTE *When the VTG is powered by the external power supply, this power off feature is disabled.*

Press any ▲ or ▼ button to select from among the power off timer options:

- Disable - disable this timer feature
- 5-minute power off time out
- 15-minute power off time out (default)
- 30-minute power off time out

Screen saver timer submenu (ScrSvr Timer)

This feature protects against CRT/plasma burn-in. When enabled, this feature allows the VTG to set the screen saver inactivity timer. This timer will activate the screen saver after the selected timer interval has elapsed without any button being pressed. See the *Screen saver mode submenu (ScrSvr)* description in this chapter for selecting a screen saver display.

Press any ▲ or ▼ button to select from among the screen saver timer options:

- Disable - disable this timer feature (default)
- 5-minute screen saver time out
- 10-minute screen saver time out
- 15-minute screen saver time out

Selecting any of the time outs will result in a modified default menu cycle, as shown below. While timed out, pressing any front panel button will cancel (disable) the time out.

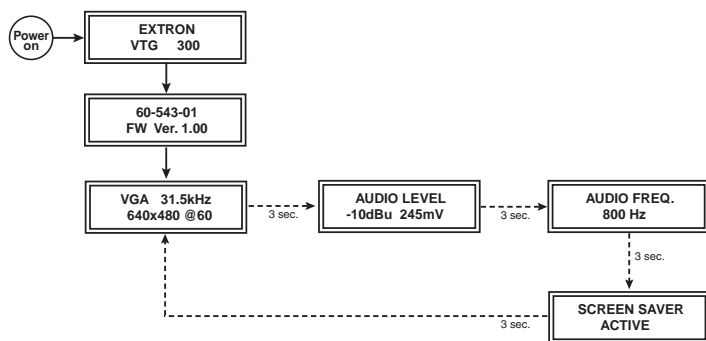

Figure 2-7 — Screen saver default menu cycle

Screen saver mode submenu (ScrSvr Mode)

If the screen saver timer has been enabled (see the previous screen saver timer submenu), the resulting screen saver display may be in one of two modes. The Blank mode will display a

blacked out screen, and the Cycle mode will display all six categories of test patterns at four-second intervals.

NOTE *Although the output screen will be blacked out when the Blank screen saver mode has been selected, the output sync will still remain active.*

Press any ▲ or ▼ button to select from among the screen saver modes:

- Blank – displays a black screen
- Cycle – displays the six test pattern categories: crosshatch, H pattern, color bars, grayscale, alternating pixels/multiburst, and white field

Figure 2-7 shows the modified default menu cycle whenever the screen saver feature is activated. The additional “Screen Saver Active” menu will be displayed in the default menu cycle.

Enable at power up submenu (Enable@PwrUp)

This submenu only displays when the VTG is powered by batteries. When enabled, this feature allows the VTG to set the active audio and/or video output during power up. This is a power saving feature of the VTG. Press any ▲ or ▼ button to enable the selected output(s):

- Last used (default) – only the last used functions (audio or video) output is enabled during power up.
- Video only (Vid) – the video outputs are enabled and the audio outputs are disabled.
- Audio only (Aud) – the audio outputs are enabled and the video outputs are disabled.
- Audio and video (Aud+Vid) – both audio and video outputs are enabled, regardless of which outputs were last used.

NOTE *If an output is disabled at power up, it can be reactivated by pressing one of its function buttons.*

NOTE *When the VTG is powered by the external power supply, both audio and video outputs are enabled regardless of the setting.*

Backlight submenu (BackLight)

This submenu only displays when the VTG is powered by batteries. When set to off (default), this feature does not illuminate the backlight of the LCD. This is a power saving feature of the VTG to extend battery life. Press any ▲ or ▼ button to turn the backlight on. When set on, the backlight goes inactive (the backlight goes off, but the backlight status is

Operation, cont'd

still set on) after 2 seconds of button inactivity, but will light again when any button is pressed.

NOTE When the VTG is powered by both the external power supply and batteries, the external power supply provides the power, not the batteries.

Unit Reset submenu (Press & Hold)

The VTG can be reset to factory default values. Any of the adjacent ▲ and ▼ button pairs (Level, Frequency, or Rate) will activate the reset.

Press and hold both ▲ and ▼ buttons simultaneously for two seconds to reset the VTG to its factory defaults.

- The message “Unit Reset to Factory Defs” will be displayed.

Exit menu

The following flowchart describes the Exit menu.

Pressing the Next button from this menu will return you to the default menu cycle.

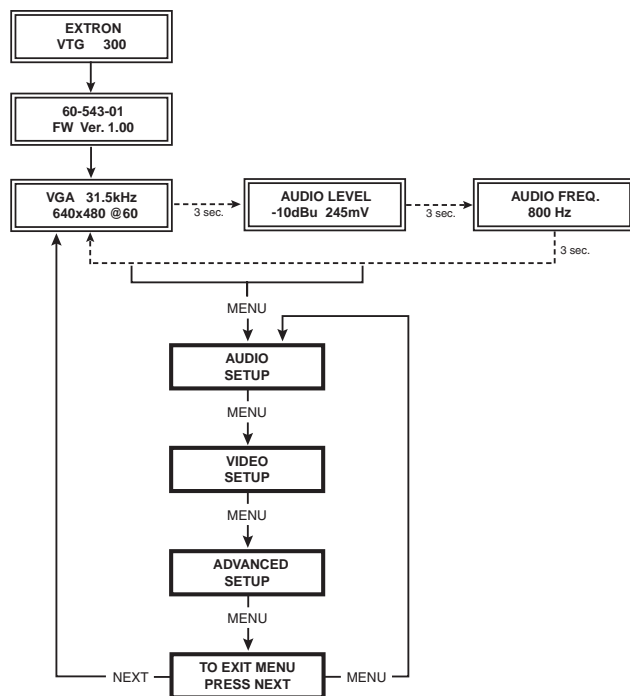

Figure 2-8 — Exit menu

Additional Functions

In addition to the main menu system, there are several other functions that are featured by the VTG. A low battery warning message and a button lock mode that locks out all front panel buttons except the power button are also featured.

Low Battery mode

When the batteries in the VTG are low and the external power supply is not connected, the message “Warning: Battery Low!” flashes on the LCD for one second every 30 seconds. To end this cycle, the external power supply needs to be connected or the batteries need to be recharged or replaced. See *Installing the VTG 300 Batteries* in this chapter.

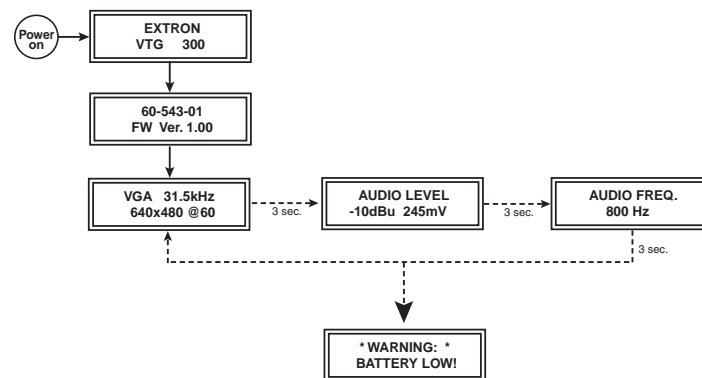

Figure 2-9 — Low battery warning mode

Button Lock mode

To prevent accidental changes to settings, simultaneously press and hold the Signal and the Test Patterns buttons for two seconds to enable the VTG’s Button Lock mode. See the following menu flowchart. Button Lock mode locks all front panel buttons except Power. When Button Lock mode has been enabled, the message “Button Lock Enabled” is displayed for 2 seconds before the VTG returns to the default cycle.

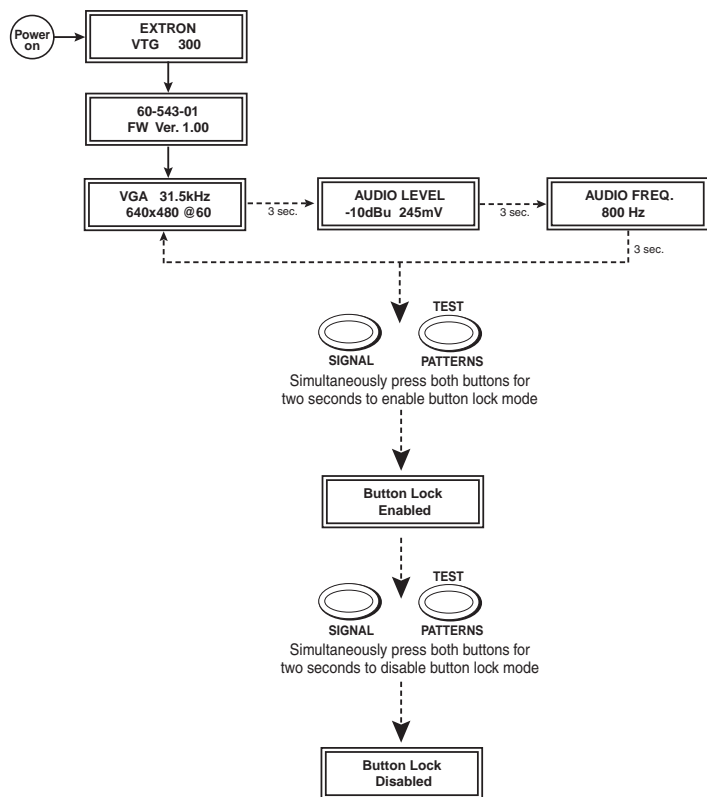

Figure 2-10 — Button Lock mode

NOTE When the VTG is in Button Lock mode and powered off and then on again, the VTG will still remain in Button Lock mode until that mode is disabled.

To disable Button Lock mode, simultaneously press and hold the Signal and the Test Patterns buttons for two seconds. When Button Lock mode has been disabled, the message “Button Lock Disabled” is displayed for 2 seconds before the VTG returns to the default cycle.

Audio Testing Features

The VTG can output from among six different audio signal formats. The audio level can also be selected from a range of levels available for each audio format.

Depending on the audio signal format, the audio frequency may be selected from a range of values.

See the *Front Panel Features* section in this chapter for button descriptions.

Selecting audio signals

The following table summarizes the six audio signal formats available through the VTG. Pressing the Signal button repeatedly will scroll through the signals and light the green LED indicators.

AUDIO SIGNAL FORMAT	DESCRIPTION
Pink Noise	Random noise that has constant energy per octave. Used in loudspeaker testing and calibration.
White Noise	Random noise that has an equal energy distribution across all frequencies between 20 Hz and 20 kHz.
Sine Wave	Used in detecting distortion. The frequency can be set from 20 Hz to 20 kHz (in 1/3 octave steps).
Square Wave	Used in amplitude and phase vs. frequency measurements. The frequency can be set from 20 Hz to 5 kHz.
Polarity test	Proprietary waveform used in verifying the polarity of audio wiring.
Swept Sine Wave	Varies the frequency of a sine wave signal continuously from 20 Hz to 20 kHz. Used to detect driver defects and mechanical sources of distortion.

Setting the audio level

The audio level for each audio signal type is selected from a range of values using the ▲ or ▼ Level buttons. The following table lists the range of values.

Audio Signal Format	Audio Level Range (in 2 dBu increments)	Audio Level Range (in 2 dBV increments)
Pink Noise	-8 dBu to -56 dBu	-10 dBV to -58 dBV
White Noise	+6 dBu to -72 dBu	+4 dBV to -74 dBV
Sine Wave	+6 dBu to -72 dBu	+4 dBV to -74 dBV
Square Wave	+6 dBu to -72 dBu	+4 dBV to -74 dBV
Polarity Test	-18 dBu to -72 dBu	-20 dBV to -74 dBV
Swept Sine Wave	+6 dBu to -72 dBu	+4 dBV to -74 dBV

NOTE Displayed levels are for high impedance loads. For 600-ohm loads, there is a -7 dB (unbalanced) / -1.3 dB (balanced) difference between the displayed and actual levels.

Setting the audio frequency

The audio frequency for each audio signal type is selected from a range of values using the ▲ or ▼ Frequency buttons and observing the LCD. The following table lists the available frequencies.

Audio Signal Format	Audio Frequencies
Pink Noise	N/A
White Noise	N/A
Sine Wave	20 Hz, 25 Hz, 31.5 Hz, 40 Hz, 50 Hz, 63 Hz, 80 Hz, 100 Hz, 125 Hz, 160 Hz, 200 Hz, 250 Hz, 315 Hz, 400 Hz, 500 Hz, 630 Hz, 800 Hz, 1.0 kHz, 1.25 kHz, 1.6 kHz, 2.0 kHz, 2.5 kHz, 3.15 kHz, 4.0 kHz, 5.0 kHz, 6.3 kHz, 8.0 kHz, 10 kHz, 12.5 kHz, 16 kHz, 20 kHz
Square Wave	20 Hz, 25 Hz, 31.5 Hz, 40 Hz, 50 Hz, 63 Hz, 80 Hz, 100 Hz, 125 Hz, 160 Hz, 200 Hz, 250 Hz, 315 Hz, 400 Hz, 500 Hz, 630 Hz, 800 Hz, 1.0 kHz, 1.25 kHz, 1.6 kHz, 2.0 kHz, 2.5 kHz, 3.15 kHz, 4.0 kHz, 5.0 kHz
Polarity Test	1 Hz
Swept Sine Wave	Sweep speed (in seconds): 150, 120, 90, 60, 30, 15, 1.5

NOTE If the audio signal format is specified as swept sine wave, the default menu cycle will not indicate an audio frequency. A sweep speed will be displayed instead as shown in the following flowchart.

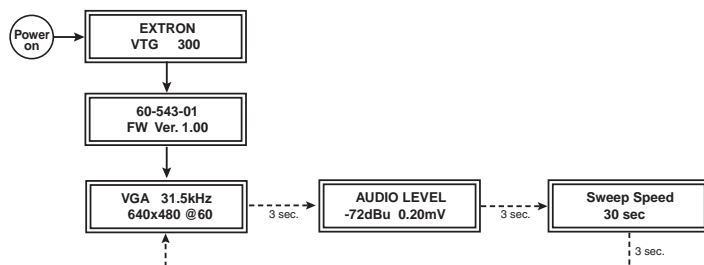

Figure 2-11 — Sweep speed submenu

Video Testing Features

The VTG can output a total of 13 different test patterns by selecting from among six categories of test patterns: crosshatch, H pattern, color bars, grayscale, alternating/multiburst, and white field. See figure 2-12..

The output rate is selected by setting the signal range and the scan rate. See the *Front Panel Features* section in this chapter for descriptions of the Test Patterns button, the Range button, and the Select button.

NOTE Refer to Test Pattern Setup menu in this chapter to change the current Grayscale or White Field pattern.

White Field	20% Window					
	80% Window					
Full Field	Full Field					
	Multiburst					
Alt/Multi	Alternating Pixels					
	Ramp					
Grayscale	32-Level Split					
	Split					
Color Bars	EBU					
	SMPTE					
H Pattern	H Pattern					
	32 x 18					
Crosshatch	32 x 24					
	480p and 576p only					
Test Pattern	Signal Range		PC	VIDEO	HDTV	16:9 HR

Figure 2-12 — Six categories of test patterns

Selecting a video test pattern

Pressing the Test Patterns button will determine what category of test pattern to display. The signal range and/or the output rate also determine the actual test pattern. See the following illustration for a description of the available test patterns.













<p>Crosshatch - 32 x 24</p>  <p>Static and Dynamic Convergence - This pattern can be used to set projector focus and geometry. For CRT projectors, this pattern is for examining and adjusting both static and dynamic convergence, so that the red, green, and blue video signals are aligned throughout the image. This pattern is also useful for evaluating some optical qualities of projector lenses, such as chromatic aberration.</p>	<p>Grayscale - 32-level split</p>  <p>Video level tracking and video gain linearity - This pattern is used for setting and assessing grayscale tracking, and evaluating contrast linearity on displays. The pattern consists of two opposing rows of 32 stepped bars of gray between the lowest and highest levels.</p>
<p>Crosshatch - 32 x 18</p>  <p>16:9 Static and Dynamic Convergence - This pattern can be used to set projector focus and geometry. For CRT projectors, this pattern is for examining and adjusting both static and dynamic convergence, so that the red, green, and blue video signals are aligned throughout the image. This pattern is also useful for evaluating some optical qualities of projector lenses, such as chromatic aberration.</p>	<p>Grayscale - ramp</p>  <p>Pixel bit depth - This pattern is used to evaluate the performance of a display or video processor on the basis of its pixel bit depth capability. The pattern should appear to be smooth, with no contouring or stepping.</p>
<p>H Pattern - white on black</p>  <p>Resolution/High Frequency Response - This pattern can be used to check display focus or video pulse response on PC, video, HDTV, and 16:9 HR equipment.</p>	<p>Alternating Pixels</p>  <p>Monitor performance - This "one pixel on, one pixel off" pattern is used for assessing the performance of high resolution monitors and projectors, EMI testing for worst case radiation, and pixel clocking and pixel phasing adjustments on a digital display.</p>
<p>Color Bars</p>  <p>8-color split bars - This pattern is used for testing all of the video color channels and setting video drive levels. It is also used to check low frequency crosstalk between the red, green, and blue color channels. Color levels are set to 100% (100 IRE).</p>	<p>Multiburst</p>  <p>Bandwidth performance - This pattern, consisting of sine wave bursts of increasing frequency, tests bandwidth performance over the NTSC and PAL video channel.</p>
<p>SMPTE Color Bars</p>  <p>SMPTE with PLUGE - For NTSC video equipment, the SMPTE color bars are used to set up tint and color, while the PLUGE video pattern is used for adjusting brightness and contrast. Color levels are set to 75% (75 IRE).</p>	<p>Flat Field (Full Field)</p>  <p>White field uniformity - This pattern is used to evaluate white field uniformity.</p>
<p>EBU Color Bars</p>  <p>EBU - The EBU color bars are primarily used to set up color for PAL video equipment.</p>	<p>White Field - 80% window</p>  <p>Color balance adjustment - A window at 80% (80 IRE) video level, surrounded by black, is used in fine tuning the color balance (or grayscale) of a display with the aid of a color analyzer. The gain (or drive) setting is fine tuned for each of the red, green, and/or blue color adjustments.</p>
	<p>White Field - 20% window</p>  <p>Color balance adjustment - A window at 20% (20 IRE) video level, surrounded by black, is used in fine tuning the color balance (or grayscale) of a display with the aid of a color analyzer. The bias (or offset) setting is fine tuned for each of the red, green, and/or blue color adjustments.</p>

Figure 2-13 — VTG 300/300R test patterns

OP

NOTE For NTSC/PAL rates, the component video output is intended for signal verification and alignment, and

Installing the Protective Boot

The included protective rubber boot protects the VTG from abuse and shock while it is in use. The boot may also be reversed to protect the front panel when not in use, as shown below.

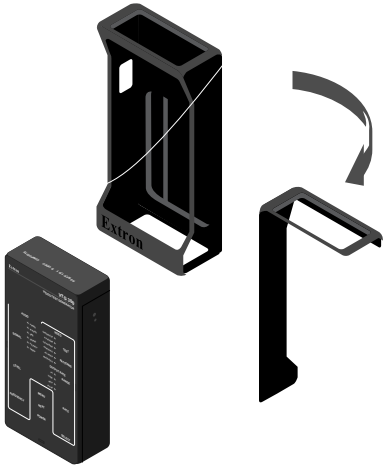



Specifications and Part Numbers

Specifications

Video signal characteristics

Dot clock	108 MHz (max.)
Pixel clock accuracy	100 ppm
Horizontal frequency	15 kHz to 127 kHz
Vertical frequency	30 Hz to 85 Hz
Rise/fall time	
Composite and S-video ..	140 ns
All other signal types	<4 ns

Video output

Number/signal type	1 RGBHV, RGBS, RGsB, RsGsBs, component video, S-video, composite video
Connectors	(1) 15-pin HD female (RGB/component) (1) 4-pin mini DIN female (S-video) 1 BNC female (composite video)
Nominal level	1 Vp-p for Y of component video and S-video, and for composite video, and also R-Y and B-Y of component video (tri-level sync) 0.7 Vp-p for RGB and for R-Y and B-Y of component video (bi-level sync) 0.286 Vp-p (burst) for C of S-video
Minimum/maximum levels	0.0 V to 1.0 Vp-p
Impedance	75 ohms
Resolutions	Computer (VGA–UXGA), video (NTSC, PAL), HDTV, and 16:9 high resolutions
Return loss	-30 dB @ 5 MHz
DC offset	±5 mV for RGB and component video, ±30 mV for S-video and composite video

Sync

Output type	RGBHV, RGBS, RGsB, RsGsBs (for RGB signals) Tri-level on Y, R-Y, B-Y channels (component video 720p, 1080i, 1080p) Bi-level on Y channel (for all other component video rates)
Standards	NTSC 3.58, PAL, SMPTE 170M, SMPTE 274M, SMPTE 293M, SMPTE 295M, SMPTE 296M

Output level	0.3 Vp-p for component video (bi-level sync) 0.6 Vp-p for component video (tri-level sync) TTL: 5.0 Vp-p, unterminated for RGBHV, RGBS
Output impedance	60 ohms
Max. rise/fall time	5 ns (TTL sync)
Polarity	Positive or negative (signal dependent)

Audio

THD + Noise	0.06% @ 1 kHz at nominal level
Flatness	±0.1 dB
Accuracy	±0.7 dB

Audio output

Number/signal type	1 mono, balanced 2 mono, unbalanced
Connectors	(1) 3.5 mm mini stereo jack (unbalanced mono left and right, tip-ring-sleeve) 1 female RCA jack (unbalanced, tip-ring) (1) male 3-pin XLR (balanced)
Impedance	50 ohms unbalanced, 100 ohms balanced
Waveforms	Pink noise, white noise, sine wave (fixed/swept), square wave, polarity test
Level ranges	Pink noise: -56 dBu to -8 dBu (-58 dBV to -10 dBV) (1.25 mV to 316 mVrms) Polarity test: -72 dBu to -18 dBu (-74 dBV to -20 dBV) (0.20 mV to 100 mVrms) All other signal types: -72 dBu to +6 dBu (-74 dBV to +4 dBV) (0.20 mV to 1.6 Vrms)
Maximum level (Hi-Z)	>+6 dBu, balanced or unbalanced at 1% THD+N
Maximum level (600 ohm)	>+5.30 dBu, balanced or unbalanced at 1% THD+N
Crest factor (pink noise)	3.06 (9.73 dB)
Crest factor (white noise)	1.73 (4.75 dB)

NOTE 0 dBu = 0.775 V, 0 dBV = 1 V, 0 dBV ≈ 2 dBu.

General

Power	Supplied by internal batteries or an external power supply
-------------	--

Specifications and Part Numbers, cont'd

External power supply	100 VAC to 240 VAC, 50/60 Hz, external, autoswitchable; to 12 VDC, 1 A, regulated
Power input requirements	12 VDC, 1 A
Batteries (VTG 300)	
Number/type	4 AA batteries (1.5 V alkaline or 1.2 V rechargeable)
Operating time (h:mm) ...	Alkaline batteries: 1:10 to 2:45, continuous use Rechargeable NiMH batteries: 1:20 to 3:10, continuous use
Batteries (VTG 300R)	
Number/type	1 rechargeable battery pack (4.8 V NiMH, 4000 mAh)
Operating time (h:mm) ...	5:10 (continuous use)
Recharging time	8 hours
Temperature/humidity	Storage: -40 to +158°F (-40 to +70 °C) / 10% to 90%, noncondensing Operating: +32 to +122°F (0 to +50 °C) / 10% to 90%, noncondensing
Rack mount	No
Enclosure type	Metal
Enclosure dimensions	6.9" H x 3.4" W x 1.5" D 17.5 cm H x 8.6 cm W x 3.8 cm D (Excluding the rubber boot, connectors, and handles.) 8.3" H x 3.9" W x 2.1" D 21.0 cm H x 9.9 cm W x 5.4 cm D (Including the rubber boot, connectors, and handles.)
Product weight	1.2 lbs (0.5 kg)
Shipping weight	4 lbs (2 kg)
Vibration	ISTA 1A in carton (International Safe Transit Association)
Listings (VTG 300 only)	UL, CUL
Compliances	CE, FCC Class A, VCCI, AS/NZS, ICES
MTBF	30,000 hours
Warranty	
Product	3 years parts and labor, excluding the VTG 300R's rechargeable battery pack
VTG 300 R battery pack ..	90 days

NOTE All nominal levels are at $\pm 10\%$

NOTE Specifications are subject to change without notice.

Included Parts

These items are included in each order for a VTG 300/300R.

Included parts	Part number
VTG 300	60-543-01
or VTG 300R	60-543-02
Rubber boot (blue)	70-370-01
VTG 300/300R User's Manual	
Label	
External power supply	70-055-03