

Sit 'n' Stroll™

5-in-1 Combination Carseat/Stroller

U.S. Patents #5,104,134 and 4,620,771 International Patents Listed Inside



1-800-829-1625



1777 South Bellaire Street, Suite 330 ♦ Denver, Colorado 80222

Phone: (303) 757-2400 ♦ Fax: (303) 757-1988

E-mail: service@safelinecorp.com ♦ Website: www.safelinecorp.com

Thank you for purchasing the Sit'n'Stroll 5-in-1 Combination Car Seat/Stroller™. The Sit'n'Stroll™ is the most advanced car seat/stroller available, and we believe the simplest, safest and most convenient way to travel with an infant.

The most important benefit the Sit'n'Stroll™ can provide is increased protection for your child. Studies have shown the use of a child restraint system reduces the likelihood of death and injury caused by the tremendous forces involved in an automobile accident. Please follow these instructions carefully to minimize the risk of injury or death to your child in the event of a sudden stop or collision. No system can guarantee the safety of your baby, but child restraints have been proven so effective they are required in all 50 states and by most industrialized nations in the world.



Child restraints could be recalled for safety reasons. You must register this restraint to be reached in a recall. Send your name, address and the restraint's model number and manufacturing date to Safeline Corporation, 1777 South Bellaire Street, Suite #330, Denver, Colorado 80222 or call 303-757-2400. For recall information, call the U.S. Government's Auto Safety Hotline at 1-800-424-9393 (202-366-0123 in D.C. area).

Limited Six Month Warranty

All Safeline products purchased from an authorized Safeline dealer are warranted against defective materials and workmanship for six months from the original date of purchase. This warranty does not include any problems associated with normal wear, abuse, misuse or negligence by the purchaser. This warranty also does not apply to any Safeline product purchased secondhand.

The purchaser must complete the owner registration card within 30 days of purchase and provide original receipt as evidence of original purchase date to file warranty claims. Registering your Safeline product assures you can be reached in the event of a safety recall. For recall information call the U.S. Government's Auto Safety Hotline at 1-800-424-9393 (202-366-0123 in D.C. area).

Safeline Corporation reserves the right to inspect all claims of defective workmanship and materials in order to determine the cause of all malfunctions. Furthermore, Safeline Corporation may exercise its right to repair, replace or refund the original purchase amount at the Company's discretion and based on the conclusions of its investigation.

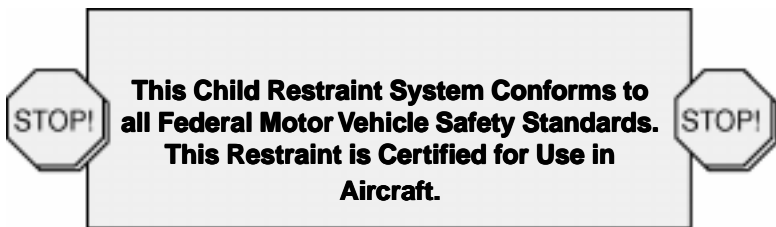

Table of Contents

Warranty	1
Get to Know Your Sit'n'Stroll™	3
Safety Guidelines: Warnings & Important Notes	4
Rear Facing or Forward Facing? Determining the Correct Seating Position	6
Securing Your Child in the Sit'n'Stroll™ & Adjusting the Harness System	7
Rear Facing	7
Forward Facing	8
Choosing an Appropriate Vehicle Seat	10
Installing the Sit'n'Stroll™ in the Vehicle	11
Rear Facing	11
Forward Facing	15
Top Tether Information	20
Installing the Top Tether	20
Rear Facing	20
Forward Facing	20
Installing the Sit'n'Stroll™ on an Aircraft	21
Converting the Sit'n'Stroll™ from Car Seat to Stroller	21
Operating the Sit'n'Stroll™ Brakes	23
Converting the Sit'n'Stroll™ from Stroller to Car Seat	24
Attaching the Sunshade	25
Removing the Harness	27
Installing the Harness	27
Maintenance and Care	28
Vehicle Manufacturer Contact Telephone Numbers and Websites	29

International Patents and Descriptions

United States	5,104,134	
	4,620,771	
ECO	257141	
France	257141	
Great Britain	257141	
Germany	P36 770 12.4	
Canada	1,277,349	
ECO	466429	
France	466429	
Great Britain	466429	
The Netherlands	466429	
Germany	69109384.9	
Japan	2,554,798	
Canada	2,046,740	<i>(Serial Number)</i>



WARNING



FAILURE TO FOLLOW EACH OF THE FOLLOWING INSTRUCTIONS CAN RESULT IN YOUR CHILD STRIKING THE VEHICLE'S INTERIOR DURING A SUDDEN STOP OR CRASH.

Get to Know Your Sit'n'Stroll™

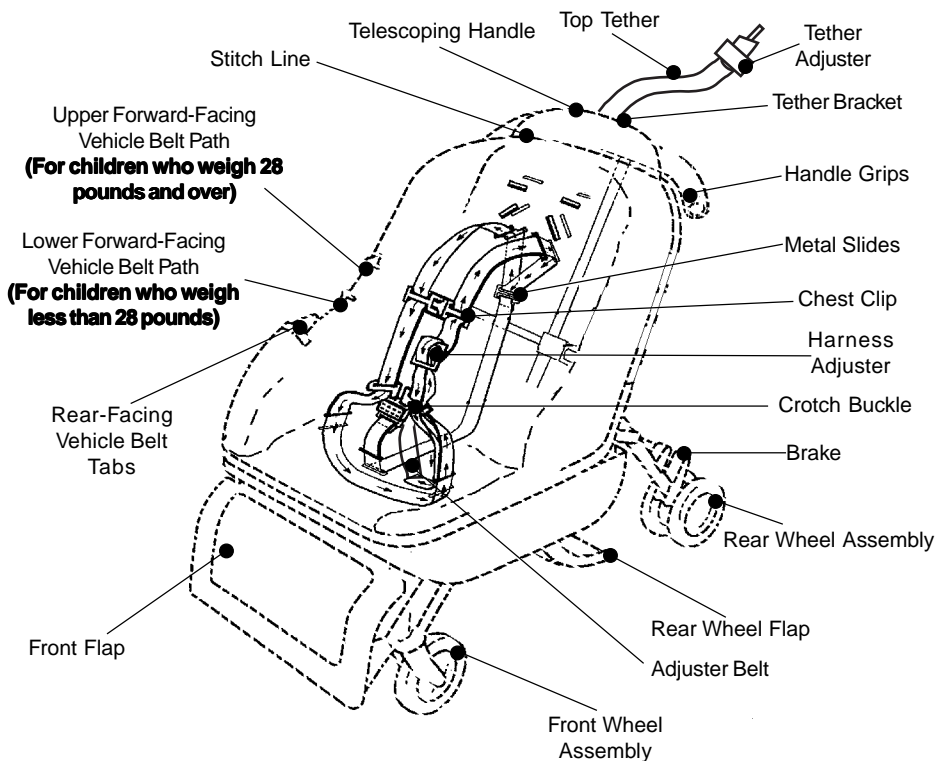

The instructions contained within this manual are guidelines for the proper use and adjustment of the Sit'n'Stroll™. Always consult with your physician to determine the specific needs of your child.



Safety Guidelines

Warnings & Important Notes

- ◆ This child restraint is designed for use by children who weigh between 5 and 40 pounds (2.3 kg to 18.1 kg) and whose height is between 18 and 40 inches (45.8 cm to 101.6 cm).
- ◆ REAR-FACING this unit is certified for use with children from 5 to 22 pounds (2.3 kg to 9.9 kg). FORWARD-FACING it is certified for use from 20 to 40 pounds (9.1 kg to 18.1 kg).
- ◆ Correct child restraint installation could be a matter of LIFE OR DEATH! You must read and follow both your child restraint and automobile owner's manual.
- ◆ If your vehicle does not have top tether anchors installed, you must contact your vehicle dealer or the vehicle manufacturer for parts, instructions and installation. See the list at the back of this manual for vehicle manufacturer contact information.
- ◆ FAILURE TO FOLLOW THE MANUFACTURER'S INSTRUCTIONS ON THE USE OF THIS CHILD RESTRAINT SYSTEM CAN RESULT IN YOUR CHILD STRIKING THE VEHICLE'S INTERIOR DURING A SUDDEN STOP OR CRASH.
- ◆ Accident statistics show that children are safer when properly secured in the back seat.
- ◆ Do not use this child restraint **rear-facing** in the front seat of a vehicle that has a passenger side airbag unless the airbag is deactivated. Airbags inflate from 100-200 mph (161-323 kph). The airbag impact can cause severe injury or death.
- ◆ If the Sit'n'Stroll™ is used **forward-facing** in the front seating position having an airbag, move the vehicle seat as far back from the airbag as possible.
- ◆ Securely belt this restraint into the vehicle at all times. An unsecured child restraint may injure other occupants if a crash occurs.
- ◆ The clothes your child wears will cause the harness fit to vary. It is necessary to adjust the tightness with EVERY trip.
- ◆ To avoid injury, this restraint should be installed and adjusted by an adult. Never allow a child to buckle themselves into this car seat.
- ◆ Metal and plastic parts can become very hot when exposed to the sun.
- ◆ When not in use, place a blanket or towel over your Sit'n'Stroll™ if it will be in the sun for long periods of time. Check to be sure the metal and plastic parts are not too hot before placing your child in the seat.
- ◆ If this restraint is involved in an accident, replace it regardless of appearance. The vehicle seat belt must also be replaced. Damage is not always visible.



Secure the Sit'n'Stroll™ in the car at all times even when not in use by your child. In the event of a sudden stop or collision, an unbelted car seat could injure other occupants in the car.



- ◆ Refer to your vehicle's owner's manual for instructions on seat belt use and how to install the restraint in your vehicle.
- ◆ Do not use this child restraint in vehicles with:
 - Hinged seat backs that do not have a locking latch
 - Passive restraint belts that do not have lap belts
- ◆ Only use the Sit'n'Stroll™ on forward-facing vehicle seats

Important Notes

- ◆ Always use good common sense! If you have questions about your Safeline product, please call us at 800-829-1625 or 303-757-2400.
- ◆ Read this instruction manual completely before using the Sit'n'Stroll™.
- ◆ Store the manual in the plastic bag and attached in the rear storage bin with the supplied hook and loop.
- ◆ The Sit'n'Stroll™ is certified for use in motor vehicles and aircraft. This child restraint system conforms to all applicable Federal motor vehicle safety standards.
- ◆ Some features of vehicle seat belts and vehicle seats that aid adult comfort and protection are not compatible with child restraints. In some vehicles, a child restraint may not fit securely in some, or any, seating positions.
- ◆ Make sure to move the vehicle seat back to the most upright position before securing the Sit'n'Stroll™ into the vehicle.
- ◆ Never carry a child on your lap while the car is moving. In the event of a crash or sudden stop, you will not be able to hold your child and they will likely be seriously injured or killed.
- ◆ Never use a vehicle seat belt which is not fully functional or has been damaged.
- ◆ Never attempt to alter or modify your Sit'n'Stroll™. Doing so could reduce the effectiveness of the restraint, possibly causing injury or death.
- ◆ Do not leave any loose objects such as books, bags, etc. in the car. They could become flying objects in the event of a crash or sudden stop. Injury could result.
- ◆ Do not place heavy objects on the Sit'n'Stroll™.
- ◆ When travelling with your children, always use your Sit'n'Stroll™, even on short trips. Remember, most crashes occur within 5 miles of the home.
- ◆ Never allow your child to unbuckle the vehicle's seat belt while the car is in motion. Your child must remain restrained by the Sit'n'Stroll™ 5-point harness system and the vehicle's seat belt at all times in order to be securely restrained.
- ◆ The shoulder straps must pass over the infant's shoulders and between the legs directly to the buckle. The child's legs should remain on either side of the crotch strap and buckle. The lap straps of the harness must always be over the top of your child's thighs.
- ◆ No one can predict if a child restraint will prevent injury or death in any given accident. However, proper use can reduce the child's risk of injury and death in most instances.



Do not place this rear-facing car seat in a vehicle seat with a passenger side air bag. In the event of a sudden stop or collision, the force of an inflating air bag can cause serious injury or death to a child. Not following this warning places your child at serious risk. Owners of vehicles with passenger side air bags should refer to their owner's manual for child restraint installation instructions.



Rear Facing or Forward Facing? Determining the Correct Seating Position

Determining the direction you should face your child is one of the most important decisions regarding the safety of a child in a car seat. Safety experts recommend your child remain in the rear-facing position until he or she is at least 20 pounds **and** at least 1 year of age. The Sit'n'Stroll™ is certified for use by children up to 22 pounds in the rear-facing position and up to 40 pounds in the forward-facing position. Consider both the weight and age guidelines when determining the direction in which you should face your child while traveling in a vehicle. A child under one year of age may not have the physiological development necessary to sustain the forces involved in a sudden stop or collision while sitting in a forward-facing position. **Consult with your physician to determine your child's specific needs.**

- ◆ Always use the Sit'n'Stroll™ rear-facing if your baby weighs less than 20 pounds or is less than 1 year of age (and less than 22lbs), unless otherwise directed by your child's physician.
- ◆ When your child weighs at least 20 pounds, but less than 22 pounds, and the top of his or her head is below the top of the stitch line, you can still use the Sit'n'Stroll™ in the rear-facing position. However, you may use the Sit'n'Stroll™ in the forward-facing position.
- ◆ If your child's head is higher than the stitch line when he or she is sitting in the Sit'n'Stroll™ or if your child weighs more than 22 pounds, you must use the Sit'n'Stroll™ in the forward-facing position.



If your child meets all of the above guidelines for the rear-facing position, but his or her legs are too long, have him or her sit with his or her legs crossed. Your child is generally safer remaining in the rear-facing position for as long as the rear-facing guidelines are applicable.

Securing your Child in the Sit'n'Stroll™ & Adjusting the Harness System



On hot or sunny days, always check the fabric and metal buckles before placing your child in the restraint to avoid burns or discomfort.



Never use the Sit'n'Stroll™ without the harness securely buckled around your child and adjusted to your child's size.

Before using your new Sit'n'Stroll™ you must adjust the harness system to fit your child. It is important to adjust the harness system every time you place your child in the Sit'n'Stroll™.



If your child is under one year of age and 22 pounds and his or her head is not yet to the top of the stitch line, you should install the Sit'n'Stroll™ rear-facing in the vehicle. If your child is over one year of age and at least 20 pounds, follow forward-facing instructions. Between 20 and 22 pounds you may use the Sit'n'Stroll™ forward-facing if your child is at least one year of age.



Rear Facing

Proper adjustment of the harness system for use rear-facing

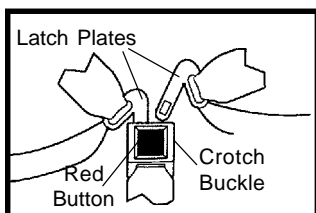

1. Open the buckle by pressing the red button and pulling the latch plates from the buckle. Open the chest clip.
2. Place your child into the seat, making sure his or her bottom is fully against the base of the seat.
3. The shoulder straps should be at or below your child's shoulders. Use the lower shoulder belt slots. Use the shortest adjuster belt loop.

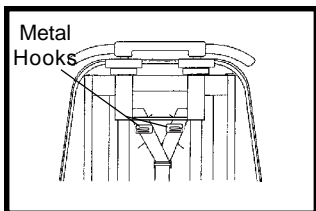

4. To move the straps to the proper slot position, loosen the harness adjuster. At the back of the Sit'n'Stroll™ remove the shoulder belts from the metal hooks. Pull the shoulder belts from the front of the seat and place back through the desired slots. Reattach the shoulder belts to the metal slots. Be sure the belts lay flat against the back of the seat shell. If they are over the stroller conversion handle you will not be able to convert the Sit'n'Stroll™ to stroller mode.
5. Ensure the belts are not twisted.
6. Click the latch plates into the buckle. Pull up on both latch plates to ensure they are securely fastened.
7. Snap the chest clip back together. Slide the chest clip so it is at your child's armpit level. If your child is smaller, you may need to remove the shoulder pads to fully tighten the harness and ensure proper placement of the chest clip.
8. Pull on the belt over the child's left leg to snug the harness. This belt goes under the seat and attaches to the right lap and shoulder belts. Tighten the harness by pulling the adjuster belt. The harness should be tight enough for you to only get one finger between the shoulder belt and your child.
9. To loosen the harness, squeeze the adjuster top and bottom and pull up.

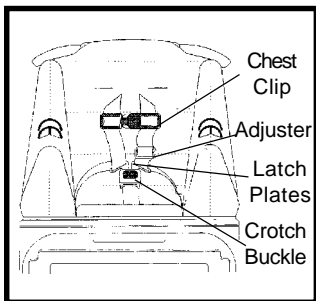

Forward Facing

Proper adjustment of the harness system for use forward-facing

1. Open the buckle by pressing the red button and pulling the latch plates from the buckle. Open the chest clip.
2. Place your child into the seat, making sure their bottom is fully against the base of the seat.
3. The shoulder straps should fit through the shoulder belt slots, which are at or above the

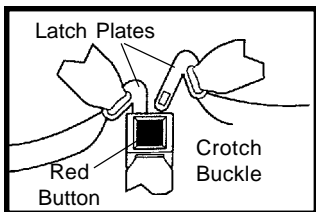

child's shoulders. If the shoulder belts are below his or her shoulders, you must adjust them to a higher set of slots.

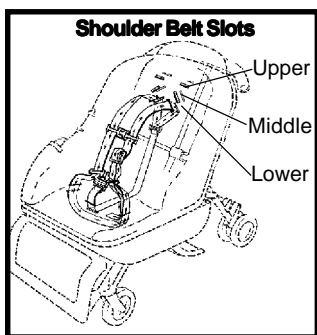

4. The adjuster belt has three loops for use depending on your child's size. When you move the shoulder belts to the middle or upper shoulder belt slots, use the middle or end adjuster belt loop.
5. To move the straps to another slot position, loosen the harness adjuster. At the back of the Sit'n'Stroll™ remove the shoulder belts from the metal hooks. Pull the shoulder belts from the front of the seat and place back through the desired slots. Reattach the shoulder belts to the metal hooks. Be sure the belts lay flat against the back of the seat shell. If they are over the stroller conversion handle you will not be able to convert the Sit'n'Stroll™ to stroller mode.
6. Ensure the belts are not twisted.
7. Click the latch plates into the buckle. Pull up on both latch plates to assure they are securely fastened.
8. Snap the chest clip together. Slide the chest clip so it is at your child's armpit level.
9. Pull on the belt over your child's left leg to snug the harness. This belt goes under the seat and attaches to the right lap and shoulder belts. Tighten the harness by pulling the adjuster belt. The harness should be tight enough for you to only get one finger between the shoulder belt and your child.
10. To loosen the harness, squeeze the adjuster top and bottom and pull up.

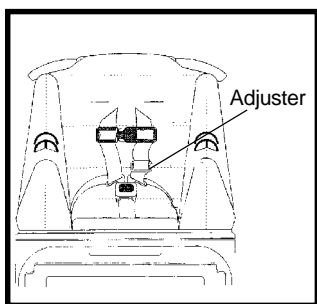

Infants and other small children may require additional head and posture support when using the Sit'n'Stroll™ to avoid injury or suffocation. Bolsters may assist in supporting the neck and head of a small child. Retailers of children's products generally carry bolsters in their accessory aisles. If you have questions regarding bolsters, please contact Safeline or the American Academy of Pediatrics.

Choosing an Appropriate Vehicle Seat Location

The Sit'n'Stroll™ was designed to be used in automobiles and airplanes, and should not be used in boats or on motorcycles. The Sit'n'Stroll™ must be positioned in a seat that faces the front of the vehicle. The Sit'n'Stroll™ was not designed to be used in seats facing the rear or the center of the vehicle, and it is dangerous to install and use the Sit'n'Stroll™ in any such seat. The back seat is the safest location for children 12 and under.

See the drawings below for further clarification.

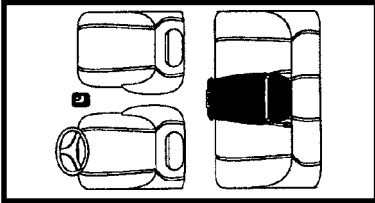

Correct Position!

The center rear seating location is generally the safest position for your child.

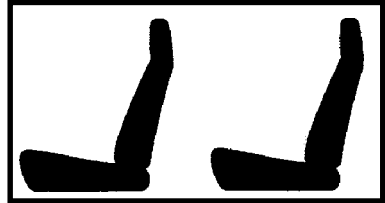

Correct Position!

Always install your Sit'n'Stroll™ in a vehicle seat that faces the front of the vehicle.

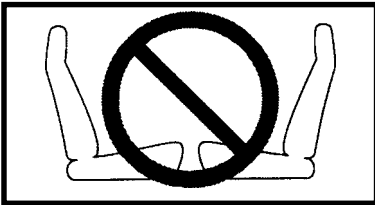

Danger!

Do not install your Sit'n'Stroll™ in a vehicle seat that faces the center of the vehicle.

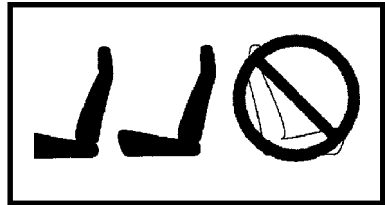

Danger!

Do not install your Sit'n'Stroll™ in a vehicle seat that faces the rear of the vehicle.



According to accident statistics, children are safer when properly restrained in the rear seating positions than in the front seating positions.



Placing your child in the forward-facing position before he or she is over one year old and over 20 pounds, places your child at serious risk. Before placing your child in the forward-facing position, consider both the weight and age guidelines for the forward-facing position. Consult with your physician to determine the individual needs of your child.

STOP!

STOP!

Installing the Sit'n'Stroll™ in the Vehicle Rear Facing



Do not use this child restraint rear facing in the front seat of a vehicle that has a passenger side airbag unless the airbag is deactivated. Airbags inflate from 100-200 mph (161-323 kph). Such a great force hitting a rear facing child restraint may severely injure or kill an infant.



If, after installing the Sit'n'Stroll™, it is not tight enough, move it to another seating location. If it still cannot be secured tightly, contact your vehicle dealer and request that a manual seat belt system be installed.

There are some vehicle seat belt systems which will not securely restrain the Sit'n'Stroll™. Follow the instructions in this manual and in the vehicle manual exactly to assure correct installation.



Never use only the top tether to install the Sit'n'Stroll™. It is necessary to use the vehicle seat belt system with the top tether. Serious injury or death could result if only the top tether is used.



If you do not use the top tether, remove the tether from the Sit'n'Stroll™ and store in a secure location. An unsecured top tether could cause injury if not properly stored.

Check your vehicle to determine which type of seat belt system you have. Some vehicles have more than one type of belt system depending on the seating position. The center rear position may have a lap only belt while the side seating locations may have a lap-shoulder system. If you are not sure which system you have, check your vehicle owner's manual or contact your vehicle dealer or manufacturer.



When using the Sit'n'Stroll™ in the rear-facing position, thread the Sit'n'Stroll™'s 5-point harness system through the shoulder slots at or below the shoulders of the child.



Automatic (passive) Seat Belts

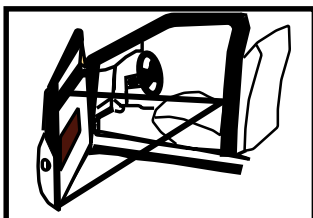

(See the picture below showing shoulder belt attached to automobile door) Check your vehicle owner's manual for advice on where and how to install a child restraint. Your vehicle dealer may have a replacement lap belt that, when installed, will hold the restraint tightly. (Disconnect the passive belt system when using a replacement lap belt.)

Lap Shoulder Belts with Sewn Latch Plates

(See the picture below showing the lap and shoulder belts sewn to the latch plate as in many General Motors vehicles)



This type of seat belt system will not hold a restraint tightly in place if the lap belt does not lock automatically. In a sudden stop or crash, the restraint may move too far forward to be safe. The only way to use this seat belt system with the Sit'n'Stroll™ is with a belt shortening (heavy duty locking) clip. Obtain belt-shortening clips from your vehicle manufacturer. To install a belt-shortening clip, see instructions provided by your vehicle dealer or vehicle owner's manual.



NEVER use the locking clip provided with the Sit'n'Stroll™ with this type of seat belt system. It is not strong enough to hold the restraint. It may bend and release the vehicle belt in the event of sudden stop or crash.



Manually Adjusted Lap Belts and Locking Latch Plates

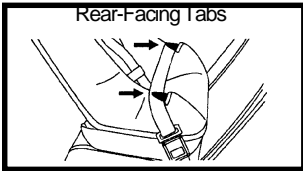
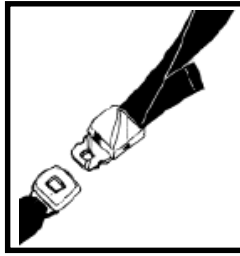

1. Place the Sit'n'Stroll™ in a rear facing position in the car.
2. Thread the lap belt through the rear facing vehicle-belt tabs. Click the latch plate into the buckle.
3. Push down firmly on the Sit'n'Stroll™ to sink it into the car's seat cushion, while pulling on the end of the lap belt or shoulder part of the lap/shoulder belt. You may have to press on one armrest at a time to get the auto belt tight. Pull the seat belt as tight as possible across the unit.
4. Be sure the back of the Sit'n'Stroll™ is at a 45-degree angle. The base of the seat should be horizontal. Use a tightly rolled towel or sheet under the seat base to adjust the angle if necessary.
5. Secure the top tether to the tether anchor in the vehicle if desired.
6. Lift up on the Sit'n'Stroll™ to check that it is securely tightened. If it moves away from the auto seat, retighten the auto seat belts.
7. If you have tightened the belt and it is still not secure, move it to another seating location and repeat steps 1-6. If there is no location in your vehicle that will securely hold the restraint, do not use it! Contact your vehicle dealer to have a vehicle belt installed that will remain tight.

Be sure the car seat belts are not twisted.

Switchable Retractors

This type of seat belt system stays loose during normal driving. However, they have special retractors which allow use with child restraints. Read your vehicle owner's manual and look for a label on the vehicle seat belt. **Note: Not all vehicle belts with switchable retractors have instructions for securing child restraints on the vehicle belt.**

1. Pull the vehicle belt all the way out.
2. Follow steps 1-6 in the directions for manually adjusted belts.
3. Check to ensure the vehicle belt is securely locked by pulling slowly on the shoulder portion of the belt. It should remain locked. If it is not locked, allow the car seat belt to fully retract and repeat.

Lap/Shoulder Belt with Buckle Tongue that Slides Freely Along Seat Belt Webbing

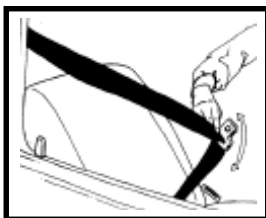

Free sliding lap/shoulder belts have a free sliding latch plate that does not lock to the belt. When placing the Sit'n'Stroll™ in seating positions equipped with this system, you must use a locking clip to prevent the seatbelt from slipping, unless it has a switchable retractor.

STOP!

STOP!

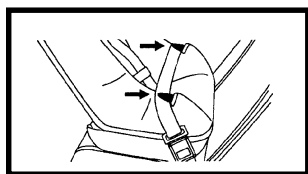

1. Place the vehicle lap belt over the Sit'n'Stroll™ and position it through the rear facing vehicle-belt tabs. Click the latch plate into the buckle.
2. Push down firmly on the Sit'n'Stroll™ to sink it into the car's seat cushion, while pulling on the shoulder part of the lap/shoulder belt. You may have to press on one armrest at a time to get the auto belt tight. Pull the seat belt as tight as possible across the unit.
3. Hold the lap and shoulder belts together behind the latch plate. Unbuckle the belt while holding the belts together.

4. Thread the locking clip onto both belts , placing it as close to the latch plate as possible.
5. Buckle the belt again. It may be necessary to press the Sit'n'Stroll™ into the auto seat cushion to get it buckled.
6. Secure the top tether to the tether anchor in the vehicle if desired.
7. Be sure the back of the Sit'n'Stroll™ is at a 45-degree angle. The base of the seat should be horizontal. Use a tightly rolled towel or sheet (or the top tether if it is being used) to adjust the angle of the seat if necessary.
8. Lift up on the Sit'n'Stroll™ to check that it is securely tightened. The belt should be tight around the restraint. If it is not, remove the locking clip and repeat steps 1-6. If you have tightened the belt and it is still not secure, move it to another seating location and repeat steps 1-7. If there is no location in your vehicle that will securely hold the restraint, do not use it! Contact your vehicle dealer to have a vehicle belt installed that will remain tight.

Installing the Sit'n'Stroll™ in the Vehicle Forward-Facing

The Sit'n'Stroll™ is equipped with two belt paths for use forward facing. The path best suited for your child is determined by their height and weight.

- ◆ If your child is taller than 33 inches and weighs over 28 pounds, the vehicle seat belt should be secured in the upper forward-facing vehicle belt path.
- ◆ If your child is under 33 inches and weighs less than 28 pounds, the vehicle seat belt should be secured in the lower forward-facing vehicle belt path.

Use the vehicle belt path based upon your child's height and weight.



If, after installing the Sit'n'Stroll™, it is not tight enough, move it to another seating location. If it still cannot be secured tightly, contact your vehicle dealer and request that a manual seat belt system be installed.



There are some vehicle seat belt systems which will not securely restrain the Sit'n'Stroll™. Follow the instructions in this manual and in the vehicle manual exactly to assure correct installation.



Never use only the top tether to install the Sit'n'Stroll™. It is necessary to use the vehicle seat belt system with the top tether. Serious injury or death could result if only the top tether is used.



If you do not use the top tether, remove the tether from the Sit'n'Stroll™ and store in a secure location. An unsecured top tether could cause injury if not properly used.

For your child's safety, the Sit'n'Stroll™'s patented design provides double-belted protection for your child and is designed to use your automobile's seat belt the way it was originally designed—to go across the front of the occupant.

Check your vehicle to determine which type of seat belt system you have. Some vehicles have more than one type of belt system depending on the seating position. The center rear position may have a lap only belt while the side seating locations may have a lap-shoulder system. If you are not sure which system you have, check your vehicle owner's manual or contact your vehicle dealer or manufacturer.

Automatic (passive) Seat Belts

See picture below showing shoulder belt attached to automobile door.

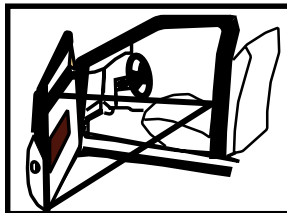

Never use an automatic seat belt system to secure the Sit'n'Stroll™ in the vehicle. The belt(s) move as the car door is opened or the engine is started and will not properly secure the Sit'n'Stroll™.



There are two basic types of automatic belts: automatic shoulder belts or and automatic lap/shoulder belts. Both types automatically move around a passenger when the car door is closed and the car is started. The seat belts will stay loose until there is a sudden stop or crash.

Check your vehicle owner's manual for advice on where and how to install a child restraint. Your vehicle dealer may have a replacement lap belt that, when installed, will hold the restraint tightly. (Disconnect the passive belt system when using a replacement lap belt.)

Lap Shoulder Belts with Sewn Latch Plates



This type of seat belt system will not hold a restraint tightly in place if the lap belt does not lock automatically. In a sudden stop or crash, the restraint may move too far forward to be safe. The only way to use this seat belt system with the Sit'n'Stroll™ is with a belt shortening (heavy duty locking) clip. Obtain belt-shortening clips from your vehicle manufacturer. To install a belt-shortening clip, see instructions provided by your vehicle dealer or vehicle owner's manual.

NEVER use the locking clip provided with the Sit'n'Stroll™ with this type of seat belt system. It is not strong enough to hold the restraint. It may bend and release the vehicle belt in the event of a sudden stop or crash.

Manually Adjusted Lap Belts and Locking Latch Plates

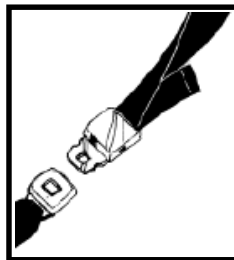



1. Place the Sit'n'Stroll™ in the vehicle forward facing.
2. Place the lap belt around the front of the Sit'n'Stroll™ and position it through the appropriate forward-facing vehicle belt path. Click the latch plate into the buckle.
3. Push down firmly on the Sit'n'Stroll™ to sink it into the car's seat cushion while pulling on the end of the lap belt or shoulder part of the lap/shoulder belt. You may have to press on one armrest at a time to get the auto belt tight. Pull the seat belt as tight as possible across the unit.
4. Secure the top tether to the vehicle tether anchor if desired.
5. Rock the Sit'n'Stroll™ sideways and pull it forward from the vehicle's seat to check it is securely tightened. If it moves away from the vehicle seat, retighten the vehicle seat belts.
6. If you have tightened the belt and it is still not secure, move it to another seating location and repeat steps 1-5. If there is no location in your vehicle that will securely hold the restraint, do not use it! Contact your vehicle dealer to have a vehicle belt installed that will remain tight.

Be sure the vehicle seat belts are not twisted.

Switchable Retractors

This type of seat belt system stays loose during normal driving. However, they have special retractors which allow use with child restraints. Read your vehicle owner's manual and look for a label on the vehicle seat belt. Note: Not all vehicle belts with switchable retractors have instructions for securing child restraints on the vehicle belt.

1. Pull the vehicle belt all the way out. You may hear a ratchet sound as the belt retracts into the car frame.
2. Follow steps 1-5 in the directions for manually adjusted belts above.
3. Ensure the vehicle belt is securely locked by pulling slowly on the shoulder portion of the belt. It should remain locked. If it is not locked, allow the car seat belt to fully retract and repeat.

Lap/Shoulder Belt with Buckle Tongue that Slides Freely Along Seat Belt Webbing

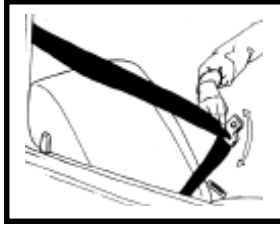

Free sliding lap/shoulder belts have a free sliding latch plate that does not lock to the belt. When placing the Sit'n'Stroll™ in seating positions equipped with this system, you must use a locking clip to prevent the seat belt from slipping, unless it has a switchable retractor.



1. Place the vehicle lap belt around the front of the Sit'n'Stroll™ and position it through the appropriate forward-facing vehicle belt path. Click the latch plate into the buckle.
2. Push down firmly on the Sit'n'Stroll™ to sink it into the car's seat cushion, while pulling on the shoulder part of the lap/shoulder belt. You may have to press on one armrest at a time to get the auto belt tight. Pull the seat belt as tight as possible across the unit.
3. Hold the lap and shoulder belts together behind the latch plate. Unbuckle the belt while holding the belts together.
4. Thread the locking clip onto both belts, placing it as close to the latch plate as possible.
5. Buckle the vehicle belt again. It may be necessary to press the Sit'n'Stroll™ into the auto seat cushion to get it buckled. The belt should be tight around the restraint. If it is not, remove the locking clip and repeat steps 1-4. If the child restraint cannot be held tightly, move it to another seating location. If there is not a position that will keep the child restraint secured with a lap belt, contact your vehicle dealer to have a lap belt installed in your vehicle.
6. Secure the top tether to the vehicle tether anchor if desired.

Top Tether Information

A top tether provides additional protection for your child. The tether reduces the possibility of serious head and neck injuries, which can cause lifelong disability or death.

Proper tether anchor hardware is required to securely fasten the top tether of the Sit'n'Stroll™ in your vehicle. Check your vehicle owner's manual for details on tethering child restraints. Most vehicles have top tether anchor kits available. Contact your vehicle dealer to obtain the top tether anchor hardware and installation or your vehicle. In many cases, you will be able to install the hardware yourself. After September 1, 1999, most new cars will have anchors as standard equipment. Most vans, SUV's and pickup trucks will have anchors a year later.

If your vehicle dealer is unable to assist you or you have additional questions, a listing of telephone numbers and web sites for most vehicle manufacturers is located at the back of this manual.

Installing the Top Tether with the Sit'n'Stroll™ Rear Facing

A rear facing child restraint may be tethered to the floor area in front of the seat. These anchor points may be identified in the vehicle owner's manual. Please consult the vehicle owner's manual, dealer or manufacturer for detailed information on suitable anchor locations.

1. The Sit'n'Stroll™ top tether attaches to a bracket under the stroller handle. Clip the hook end of the tether to the Sit'n'Stroll™ tether bracket before placing in the vehicle seat. Next, secure the Sit'n'Stroll™ with the vehicle seat belts.
2. Clip the adjuster end of the top tether to the vehicle anchor point.
3. Pull the tether adjuster strap to tighten the top tether. The Sit'n'Stroll™ seat back angle should not be lower than 45- degrees from horizontal.
4. To release the top tether, pull up on the tether adjuster tab. If the tether is very tight, pushing down on the back on the Sit'n'Stroll™ will help release the adjuster.



Do Not OVER-TIGHTEN THE TOP TETHER WHEN THE SIT'N'STROLL™ IS REAR FACING! A seat back angle of less than 45 -degrees (from horizontal) could cause your child to move too far forward in the event of a sudden stop or crash. Severe injury could result.



Installing the Top Tether with the Sit'n'Stroll™ Forward Facing

1. The Sit'n'Stroll™ top tether attaches to a bracket under the stroller handle. Clip the hook end of the tether to the Sit'n'Stroll™ tether bracket before placing in the vehicle seat.
2. Clip the adjuster end of the tether to the anchor in the vehicle behind the Sit'n'Stroll™.
3. Secure the Sit'n'Stroll™ with the vehicle belts.
4. Pull on the tether adjuster strap to tighten.
5. To release the top tether, pull up on the adjuster tab. If the tether is very tight, pushing back on the Sit'n'Stroll™ will help release the adjuster.

Installing the Sit'n'Stroll™ on an Aircraft

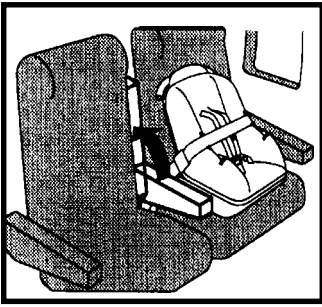

1. Contact the airline prior to taking the child restraint on board the aircraft.
2. Install the Sit'n'Stroll™ in the airline seat the same way you would when using it in a car. You may need to raise the armrests in the aircraft to allow room for the Sit'n'Stroll™. After the Sit'n'Stroll™ is in place, you can usually lower the armrest back into place. If you are seated behind the bulkhead where the armrests don't raise, you can usually slide the Sit'n'Stroll™ like a tray in between the armrests and the seat cushion.
3. Regular luggage checking of a Sit'n'Stroll™ may result in damage to the unit. We suggest you gate check your unit if necessary.



Contact your airline and inquire if they offer special rates for children traveling in car seats.



In private aircraft, do not install the car seat where it will block an exit from the aircraft or where it could block or inhibit the use of flight controls.



Do not place the car seat next to an emergency exit or in a seat row which contains an emergency exit.



*FAA certification does not guarantee the Sit'n'Stroll™ will fit in all airline seats. Contact your airline prior to traveling to determine the width of the airplane seats. Provided you have purchased a ticket for your child, the carseat fits into the airline seat and the carseat has the yellow FAA-certification sticker attached, the airline cannot refuse your right to use your carseat on the airplane. For more information go to www.faa.gov and refer to **Part 125**.*

Converting the Sit'n'Stroll™ from Car Seat to Stroller

For your child's comfort, the Sit'n'Stroll™ utilizes an advanced torsional suspension system that is active while the unit is in stroller mode. It is normal for the stroller to flex and have a springy feel just like your car. The suspension system aids in ride comfort for your child and prevents damage to the components. The Sit'n'Stroll™ handle incorporates flex steering which means the "looseness" you feel is normal and aids in maneuvering the stroller.



Tips

The Sit'n'Stroll™ is designed to be converted from car seat to stroller and back again while holding the child, still secured in the Sit'n'Stroll™, OFF THE GROUND. If the Sit'n'Stroll™ is converted on the ground, the mechanism may jam.



The Sit'n'Stroll™ is to be used only by one child at a time. Never place more than one child in the seat.



Until you are well practiced in following these instructions, do not attempt to convert from car seat to stroller or vice-versa with your child in the seat.

Always secure your child using the Sit'n'Stroll™'s 5-point harness system.



Individuals with a history of back trouble are advised to exercise caution or refrain from quick movement when converting the Sit'n'Stroll with a child in it. Do not attempt to convert the unit if you are at risk of back injury.



WARNING



Excess weight placed in the storage bin may cause a hazardous unstable condition. The manufacturer recommends not to exceed 10 pounds. Parcels or accessory items or both placed on the unit may cause the unit to become unstable.

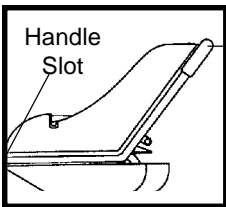

Handle Slot
Slider Grip

1. Place one hand in the handle slot located between your infant's feet. With your other hand, grasp the slider grip located on the back of the Sit'n'Stroll™. Gripping both handles securely, remove the Sit'n'Stroll™ from your vehicle. Squeeze the red lock release evenly with your fingers and move the slider grip down. This deploys the wheels.
2. When the slider stops, relax your finger pressure on the red lock release and allow it to latch securely in its lowest position. Pull up on the grip without squeezing the red lock release to ensure the wheels are locked. Place the Sit'n'Stroll™ on the ground.

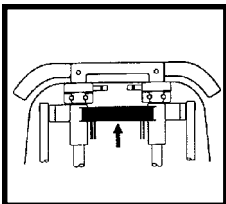

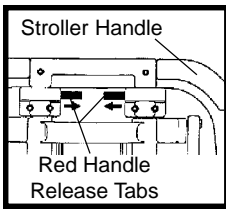

3. With one hand, compress the red handle release tabs located under the stroller handle, and with the other hand, pull up on the stroller handle. Select one of the four (4) handle height positions and release the red handle release tabs to lock the stroller handle into place.



Never use the stroller when 4 holes are showing on the handle tube. Always ensure the red handle release tabs are engaged with one of the four sets of holes in the handle tubes. Before using the Sit'n'Stroll™ as a stroller, ensure the handle is locked and cannot slide up or down.



The arm moving the slider grip should be on the side of the Sit'n'Stroll™. You do not want your arm over the top of the stroller handle.

When converting from the car seat to the stroller position, support the Sit'n'Stroll™ with your hip. Do not block the front or the rear wheel flaps with your leg.



When converting the Sit'n'Stroll™, right-handers should face the child's left side.

Operating the Sit'n'Stroll™ Brakes

- ◆ If your Sit'n'Stroll™ was manufactured before September 19, 1998, locate the red brake tabs on the aluminum legs above your rear wheels. Use your hand to push the brake straight down the metal tube. It will engage with the spokes of the wheels and will lock the stroller in place. To unlock the brake, pull in the opposite direction until the brake has disengaged from the wheel spokes and locks in its uppermost position.
- ◆ If your Sit'n'Stroll™ was manufactured after September 19, 1998, your brakes will be located directly on the rear wheel set. To engage the brakes, simply push the red brake tab toward the ground. Disengage the brake by pulling the red brake tab back toward the body of the Sit'n'Stroll™.

Converting the Sit'n'Stroll™ from Stroller to Car Seat

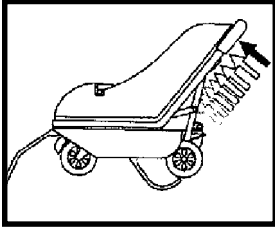
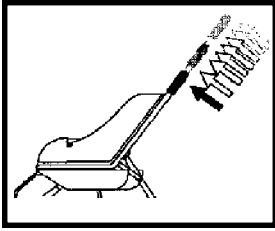

1. Compress the red handle release tabs and push the stroller handle down until it locks in its lowest position.
2. Align the front wheels by rolling the stroller back 6 to 12 inches. Place one hand in the slot handle located between your infant's feet. With your other hand, grasp the slider grip located on the back of the seat. **Lift the seat off the ground.**
3. Squeeze the red lock release evenly with your fingertips and slide the slider grip up to its stop position. Relax your finger pressure on the red lock release. Push down on the slider grip to ensure the wheels are properly locked. The wheels should now be stored behind their protective flaps.



Maneuvering Over Curbs: Always back up to the curb, pull up on the telescoping handle and lift the rear wheels over the curb. Pull the stroller backwards and allow the front wheels to ride up over the curb. Never push down on the telescoping handle to prop the front wheels on the curb first. The pressure placed on the handle may cause damage.



Locking the Wheels: When converting the Sit'n'Stroll™ from stroller to car seat, the wheels must lock in the uppermost position. To ensure the wheels lock properly, keep your finger tips on the slider and squeeze evenly over the entire surface of the slider button until the wheels are up. Grab the top of the seat (near the red handle release tabs) with your thumb and squeeze your thumb and fingers together until the wheels click into place, indicating the wheels are properly locked.

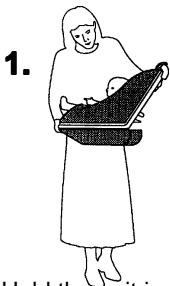

1. Hold the unit in the air to convert.



2. Deploy the wheels.



3. Place the Sit'n'Stroll on the ground and deploy the handles.



4. Away you go!

The Sit'n'Stroll™ Sunshade

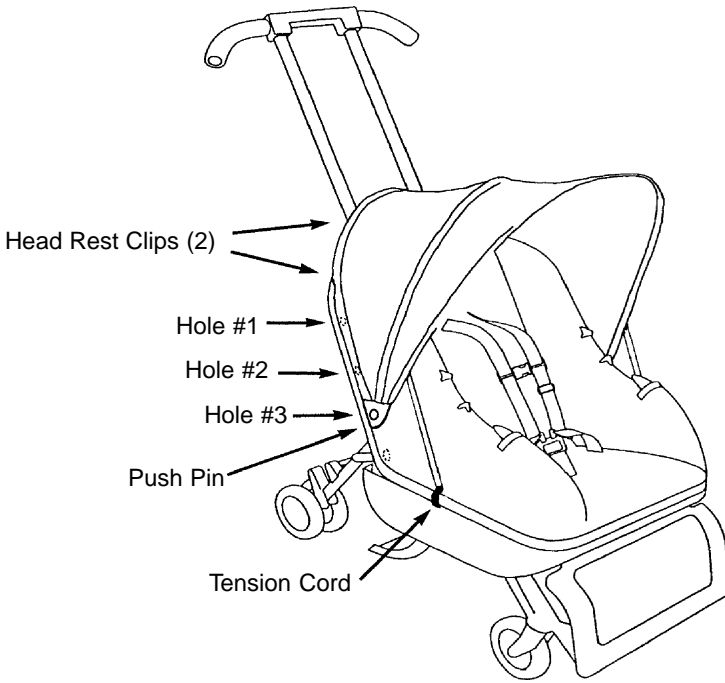

Attaching the Sunshade

1. Attach the head rest clips to the top of edge of the seat back, on either side of the handle tubes.
2. Push the edge of the seat cover forward exposing the plastic shell. Locate the third hole down from the top.
3. Keep the seat cover fabric pushed forward and press the push pin (sewn into the bottom portion of the sunshade) into the third hole until it clicks into place. Repeat this procedure for both sides of the sunshade.
4. Pull the tension cords down and attach to the bottom of the seat (as shown) to increase the sunshade's coverage. Pull the tension cord back over the sunshade and attach to the back of the seat in order to pull the shade away from the baby.

Removing the Sunshade

1. Reach behind the seat shell and use your finger tips to press the push pins outward until they pop free from the seat shell hole.
2. Carefully remove the remaining head rest clips and tension cord clips attached to the side of the seat's shell.

Tips

For your child's safety, the Sit'n'Stroll™ utilizes a continuous-loop 5-point harness system—the kind most recommended by safety experts.



Never use the Sit'n'Stroll™ without the harness securely buckled.

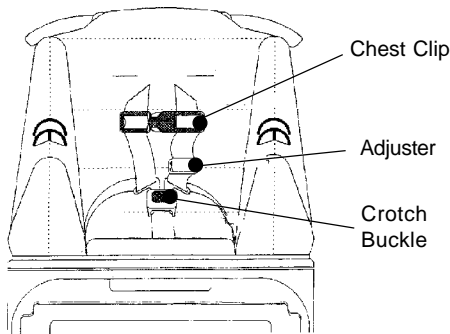
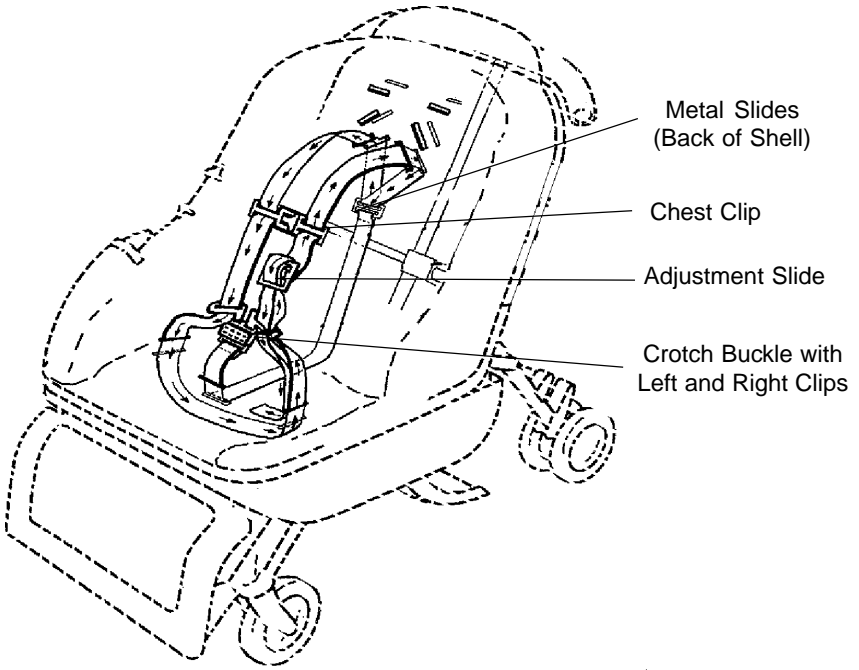



The harness must always be routed through (i.e. behind and under) the plastic shell. Never route the harness through the fabric cover only.



Removing the Harness

To remove the fabric cover for washing it will be necessary to remove the harness system.

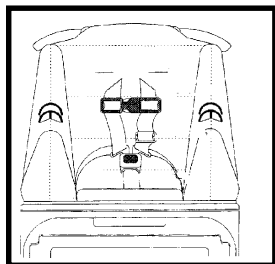

1. Unhook the shoulder belt loops from the metal hooks at the back of the seat.
2. Pull the shoulder belts through the seat back from the front of the seat.
3. Remove the chest clip half from the child's right shoulder belt.
4. The right shoulder belt continues down through the latch plate and under the seat bottom. Pull this belt all the way out from under the seat so it comes out the child's left side (your right side when facing the front of the Sit'n'Stroll™). The upper part of the harness is now free of the seat pad.
5. Release the latch plates from the buckle. Gently slide the buckle down through the crotch strap slot in the fabric cover being careful to not tear the pad slot. Turning the buckle sideways may help it fit through the pad slot.
6. The fabric cover is now free to be unclipped from the shell and removed for washing.

Installing the Harness

1. Be sure the fabric cover is on and gently slide the buckle up through the crotch strap slot. Turning the buckle sideways may help it fit through the crotch strap slot.
2. Replace the latch plates into the buckle and snap the chest clip together. The Sit'n'Stroll™ should be in the stroller position with the telescoping handle down.
3. Be sure the harness adjuster is on the child's left side of the seat (your right while facing the Sit'n'Stroll™). Slide the upper adjuster belt loop through the appropriate shoulder belt slot to the back of the seat and fasten to the metal hook.
4. Push the long shoulder belt down through the slot at the child's left hip, around the bottom of the shell and up through the slot near the child's right hip.

5. The strap should then be placed through the child's right latch plate (back to front), up through the chest clip and through the appropriate shoulder belt slot on the seat back.
6. Fasten the loop on the end of the strap to the second metal hook.
7. Check to be sure that the webbing is not twisted. The web should lie flat against the bottom of the seat shell.

Maintenance and Care

Washing the Cover and Harness

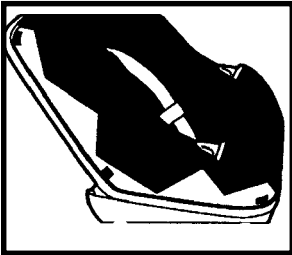

1. Remove the harness from the Sit'n'Stroll™ and detach all buckles.
2. Release the clips securing the fabric cover to the car seat and remove the cover from the plastic shell.
3. Wash the cover and harness in cold water on gentle cycle with a mild detergent. Do not use bleach. Roll in towel to remove excess water after rinsing. Hang the fabric cover to dry or tumble dry without heat. Do not dry in a heated dryer.

Washing the Shell

Wash the car seat shell and stroller parts with a mild soap and warm water using a soft cloth or sponge.

Wheels and Handle System

If needed, clean the wheels and telescoping handle with Armor All® spray lubricant.

To lubricate the moving parts of the Sit'n'Stroll™, use a silicon wax-based lubricant. Do not use an oil-based lubricant anywhere on the Sit'n'Stroll™. An oil-based lubricant will corrode the plastic components and will inhibit further operation of the unit. You may order the proper lubricant directly from Safeline Corporation.

Replacement Parts

We have carefully designed all of the high wear parts of the Sit'n'Stroll™ to be easily replaceable. For increased longevity and years of enjoyment, contact our main office to order replacement parts at reasonable prices.

Vehicle Manufacturer Contact Telephone Numbers and Websites

Acura Division of American Honda	(800) 382-2238	www.acura.com
Audi of America, Inc.	(800) 822-2834	www.audiusa.com
BMW of North America, Inc.	(800) 831-1117	www.bmwusa.com
Chrysler - DaimlerChrysler Corp.	(800) 992-1997	www.chryslercorp.com
Dodge - DaimlerChrysler Corp.	(800) 992-1997	www.chryslercorp.com
Ford Motor Company	(800) 392-3673	www.ford.com
Buick - General Motors Corp.	(800) 521-7300	www.buick.com
Cadillac - General Motors Corp.	(800) 458-8006	www.cadillac.com
Chevrolet/GEO - General Motors Corp.	(800) 222-1020	www.chevrolet.com
GMC - General Motors Corp.	(800) 462-8782	www.gmc.com
Oldsmobile - General Motors Corp.	(800) 442-6537	www.oldsmobile.com
Pontiac - General Motors Corp.	(800) 762-2737	www.pontiac.com
Saab - General Motors Corp.	(800) 955-9007	www.saabusa.com
Saturn - General Motors Corp.	(800) 553-6000	www.saturn.com
Suzuki - General Motors Corp.	(800) 934-0934	www.suzuki.com
Honda, American	(800) 999-1009	www.honda.com
Hyundai Motor America	(800) 633-5151	www.hyundai.com
Infinity	(800) 662-6200	www.infinity-usa.com
Isuzu Motors Inc., America	(800) 255-6727	www.isuzu.com
Jaguar Cars	(800) 452-4827	www.jaguar.com
Jeep/Eagle - DaimlerChrysler Corp.	(800) 992-1997	www.chryslercorp.com
Kia Motors America, Inc.	(800) 333-4KIA	www.kia.com
Land Rover North America, Inc.	(800) 637-6837	www.landrover.com
Mazda	(800) 222-5500	www.mazdausa.com , www.miata.net
Mercedes-Benz of North America	(800) 367-6372	www.mbusa.com
Mitsubishi Motors America	(800) 222-0037	www.mitsucars.com
Nissan Motor Corp., USA	(800) 647-7261	www.nissan-na.com
Plymouth - DaimlerChrysler Corp.	(800) 992-1997	www.chryslercorp.com
Porsche Cars North America, Inc.	(800) 545-8039	www.porsche.com
Subaru of America, Inc.	(800) 782-2783	www.subaru.com
Toyota Motor Sales, U.S.A.	(800) 331-4331	www.toyota.com
Volkswagen of America, Inc.	(800) 822-8987	www.vw.com
Volvo Cars of North America	(800) 458-1552	www.volvocars.com



800-829-1625

Made in Taiwan, R.O.C.
Under the Supervision of Safeline Corporation