



# Use and Care Guide

## Built-in Oven



Safety instructions .....3, 4



### Operating Instructions, Tips

Aluminum Foil .....	4, 21, 27
<b>Convection</b> .....	11-17
Baking .....	12-14
<b>Roasting</b> .....	15-17
Special Roasting Rack .....	15
Features .....	5
Oven .....	17-28
Baking .....	17, 20, 21
Broiling, Broiling Guide .....	27, 28
Control Panel .....	6, 8
Clock and Timer .....	7, 8
Light; Bulb Replacement .....	10, 35
Multi-Shelf Baking .....	12
Offset Shelf .....	9, 12, 15, 16
Preheating .....	20
Probe .....	16, 24, 25
Roasting, Roasting Guide .....	23, 26
Roasting with the Probe .....	24, 25
Self-Cleaning Instructions .....	29-32
Shelves .....	9, 10, 12
Timed Baking .....	18, 19



<b>Problem Solver</b> .....	37, 38
<b>Thermostat Adjustment—</b>	
Do It Yourself .....	22
More questions ?...call	
<b>GE Answer Center® 800.626.2000</b>	



Care and Cleaning .....	33-36
Broiler Pan and Grid .....	33
Oven Door .....	34
Oven Shelves .....	33
Probe .....	35
Removal of Packaging Tape .....	33



Consumer Services .....	39
Appliance Registration .....	2
Important Phone Numbers .....	39
Model and Serial No. Location .....	2
Warranty .....	Back Cover

GE Appliances

Models: JKP16  
JKP17  
JKP18



## HELP US HELP YOU...

### **Before using your oven, read this guide carefully.**

It is intended to help you operate and maintain your new oven properly.

Keep it handy for answers to your questions.

If you don't understand something or need more help, write (include your phone number):

Consumer Affairs  
GE Appliances  
Appliance Park  
Louisville, KY 40225

### **Write down the model and serial numbers.**

You'll find them on a label on the front of the oven behind the oven door.

These numbers are also on the Consumer Product Ownership Registration Card that came with your oven. Before sending in this card, please write these numbers here:

\_\_\_\_\_  
Model Number

\_\_\_\_\_  
Serial Number

Use these numbers in any correspondence or service calls concerning your oven.

### **If you received a damaged oven...**

[mediately contact the dealer (or builder) that sold you the oven.

### **Save time and money. Before you request service . . .**

Check the Problem Solver in the back of this guide. It lists causes of minor operating problems that you can correct yourself.

---

## IF YOU NEED SERVICE...

To obtain service, see the Consumer Services page in the back of this guide.

We're proud of our service and want you to be pleased. If for some reason you are not happy with the service you receive, here are 3 steps to follow for further help.

**FIRST**, contact the people who serviced your appliance. Explain why you are not pleased. In most cases, this will solve the problem.

**NEXT**, if you are still not pleased, write all the details—including your phone number—to:

Manager, Consumer Relations GE Appliances  
Appliance Park  
Louisville, KY 40225

**FINALLY**, if your problem is still not resolved, write:

Major Appliance Consumer Action Panel  
20 North Wacker Drive  
Chicago, IL 60606

# IMPORTANT SAFETY INSTRUCTIONS

Read all instructions before using this appliance.



## IMPORTANT SAFETY NOTICE

• **The California Safe Drinking Water and Toxic Enforcement Act** requires the Governor of California to publish a list of substances known to the state to cause birth defects or other reproductive harm, and requires businesses to warn customers of potential exposure to such substances.

• **The fiberglass insulation in self-cleaning ovens gives off a very small amount of carbon monoxide during the cleaning cycle.** Exposure can be minimized by venting with an open window or using a ventilation fan or hood.

When using electrical appliances, basic safety precautions should be followed, including the following:

• **Have the installer show you the location of the circuit breaker or fuse.** Mark it for easy reference.

• **Use this appliance only for its intended use as described in this guide.**

• **Be sure your appliance is properly installed and grounded** by a qualified technician in accordance with the provided Installation Instructions.

• **Do not attempt to repair or replace any part of your oven unless it is specifically recommended in this guide.** All other servicing should be referred to a qualified technician.

• **Before performing any service, DISCONNECT THE OVEN POWER SUPPLY AT THE HOUSEHOLD DISTRIBUTION PANEL BY REMOVING THE FUSE OR SWITCHING OFF THE CIRCUIT BREAKER.**

• **Do not leave children alone—Children should not be left alone or unattended in an area where appliance is in use.** They should never be allowed to sit or stand on any part of the appliance.

• **Do not allow anyone to climb, stand or hang on the door.** They could damage the oven or cause severe personal injury.

• **CAUTION: ITEMS OF INTEREST TO CHILDREN SHOULD NOT BE STORED IN CABINETS ABOVE AN OVEN. CHILDREN CLIMBING ON THE OVEN TO REACH ITEMS COULD BE SERIOUSLY INJURED.**

• **Teach children not to play with the controls or any other part of the oven.**

• **Never leave the oven door open** when you are not watching the oven,

• **Always keep combustible wall coverings, curtains or drapes a safe distance from your oven.**

• **Never wear loose-fitting or hanging garments while using the appliance.** Be careful when reaching for items stored in cabinets over the oven. Flammable material could be ignited if brought in contact with hot heating elements and may cause severe burns.

• **DO NOT STORE OR USE COMBUSTIBLE MATERIALS, GASOLINE OR OTHER FLAMMABLE VAPORS AND LIQUIDS IN THE VICINITY OF THIS OR ANY OTHER APPLIANCE**



• **Use only dry pot holders—Moist or damp pot holders on hot surfaces may result in burns from steam. Do not let pot holders touch hot heating elements.** Do not use a towel or other bulky cloth. Such cloths can catch fire on a hot heating element.

• **Always keep dish towels, dish cloths, pot holders and other linens a safe distance from your oven.**

• **Always keep wooden and plastic utensils and canned food a safe distance away from your oven.**

• **Never use your appliance for warming or heating the room.**

• **Storage in or on appliance—Do not store flammable materials in the oven.**



• **Do not let cooking grease or other flammable materials accumulate in or near the oven.**

• **Be sure the oven is securely installed in a cabinet that is firmly attached to the house structure.** Weight on the oven door could cause the oven to tip and result in injury. Never allow anyone to climb, sit or stand on the oven door.

(continued next page)



# IMPORTANT SAFETY INSTRUCTIONS

(continued)

**• Do not use water on grease fires.**

Smother fire or flame or use a dry chemical or foam-type extinguisher.

Flame in the oven can be smothered completely by closing the oven door and turning the oven off or by using a dry chemical or foam-type fire extinguisher,

**• Do not touch the heating elements or the interior surface of the oven. These surfaces may be hot enough to burn even though they are dark in color. During and after use, do not touch, or let clothing or other flammable materials contact any interior area of the oven; allow sufficient time for cooling, first.**

Potentially hot surfaces include the oven vent openings and surfaces near the openings, crevices around the oven door, the edges of the door window and metal trim parts above the door.

**Remember: The inside surface of the oven may be hot when the door is opened.**

**• When cooking pork, follow the directions exactly and always cook the meat to an internal temperature of at least 170°F. This assures that, in the remote possibility that trichina may be present in the meat, it will be killed and the meat will be safe to eat.**

---

## Oven

**• Stand away from the oven when opening the oven door.** The hot air or steam which escapes can burn hands, face and/or eyes.

**• Do not heat unopened food containers.**

Pressure could build up and the container could burst, causing an injury.

**• Keep the oven vent duct unobstructed.**

**• Keep the oven free from grease buildup.**

**• Place the oven shelf in the desired position while the oven is COOL.** If the shelves must be handled when hot, do not let the potholder contact the heating elements.

**• Pulling out the shelf to the shelf stop is a convenience in lifting heavy foods.** It is also a precaution against burns from touching the hot surfaces of the door or the the oven walls.

**• When using cooking or roasting bags in the oven,** follow the manufacturer's directions.

**• Do not use your oven to dry newspapers.** If overheated, they can catch on fire.

**• Do not leave paper products, cooking utensils, or food in the oven when not in use.**

**• After broiling, always take the broiler pan out of the oven and clean it.** Leftover grease in the broiler pan can catch on fire the next time you use the pan.

**• Never leave jars or cans of fat dripping on or near your oven.**

**• Do not use aluminum foil to line oven bottoms, except as suggested in this guide.** Improper installation of these liners may result in a risk of electric shock or fire.

---

## Self-Cleaning Oven

**• Do not clean the door gasket.** The door gasket is essential for a good seal. Care should be taken not to rub, damage or move the gasket.

**• Do not use oven cleaners.** No commercial oven cleaner or oven liner protective coating of any kind should be used in or around any part of the oven. Residue from oven cleaners will damage the inside of the oven when the self-clean cycle is used.

**• Clean only parts listed in this Use and Care Guide.**

**• Before self-cleaning the oven,** remove the broiler pan and other cookware.

**• Be sure to wipe up excess spillage before starting the self-cleaning operation.**

**• If the self-cleaning mode malfunctions,** turn the oven OFF and disconnect the power supply. Have it serviced by a qualified technician.

**SAVE THESE  
INSTRUCTIONS**

# FEATURES OF YOUR OVEN

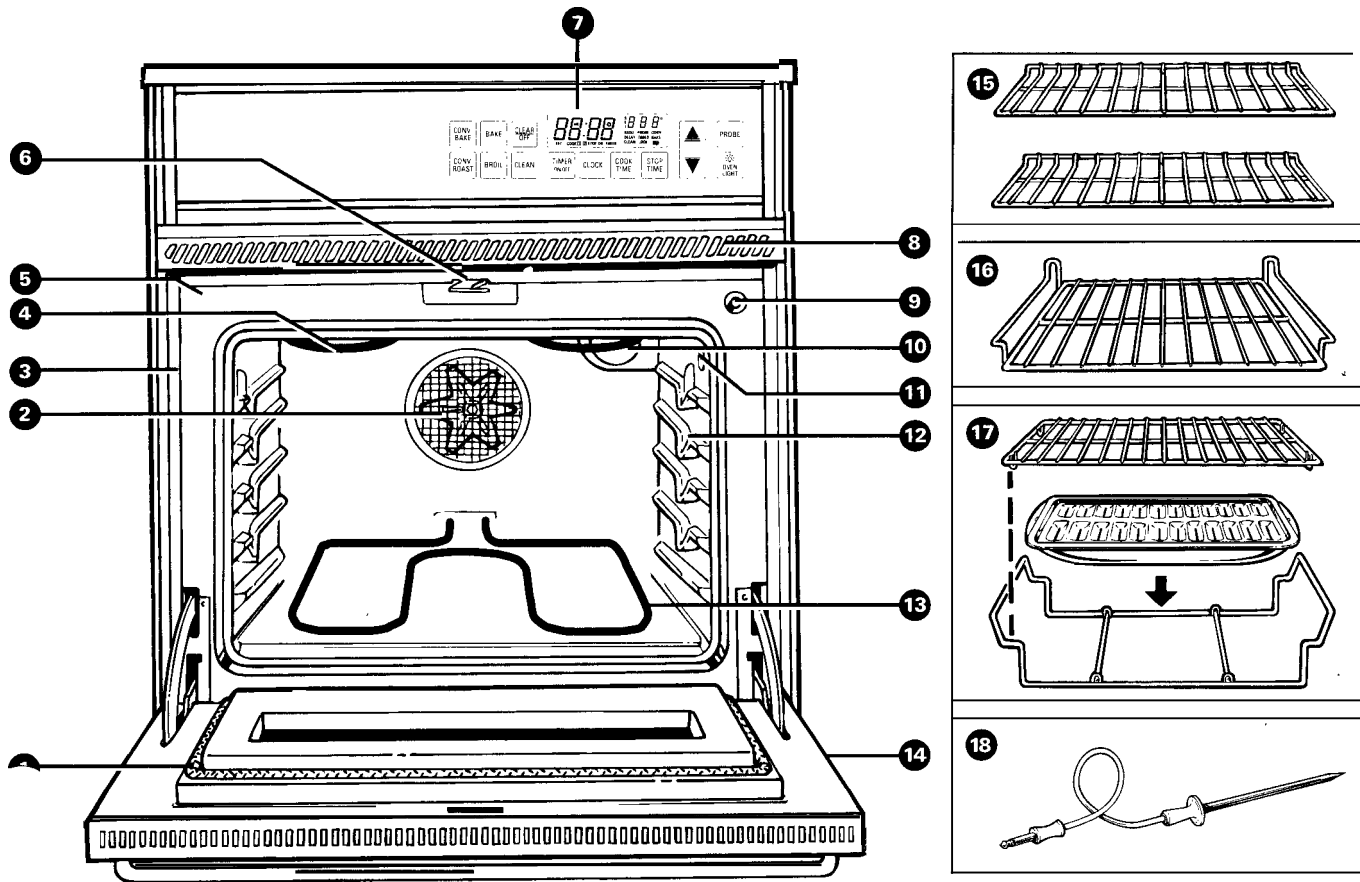

Important Safety Instructions

Features of Your Oven

Feature Index	Explained on page
<b>1 OvenDoorGasket</b>	<b>4,29,34</b>
<b>2 Convection FanandHeating Element (operates during convection cooking)</b>	11
<b>3 Model and Serial Numbers</b>	2
<b>4 Oven Broil Unit</b>	27, 29
<b>5 Oven Vent</b>	4
<b>6 Automatic Oven Door Latch</b>	30,31
<b>7 Oven Control, Clock and Timer</b>	<b>7,8</b>
<b>8 Oven Vent Grille</b>	<b>1-</b>
<b>9 Automatic Oven Light Switch</b>	<b>10</b>
<b>Oven Interior Light</b>	<b>10,29,35</b>
<b>11 Probe Outlet</b>	<b>16,24,25</b>

Feature Index	Explained on page
<b>12 Oven Shelf Supports</b> Shelf positions for cooking are suggested in the Baking, Roasting and Broiling sections.	10, 12
<b>13 Bake Unit</b> May be lifted gently for wiping the oven floor.	29
<b>14 Lift-Off Oven Door with Broil Stop Position</b> Easily removed for cleaning.	26,34
<b>15 Oven Shelves with Stop-Locks</b>	9, 10, 12, 20,33
<b>16 Offset Shelf</b>	9, 12, 15,33
<b>17 Broiler Pan and Grid, Roasting Rack and Stand</b>	15,23,27, 28,33
<b>18 Probe</b>	16,24, 25, 35



## FEATURES OF YOUR OVEN CONTROL

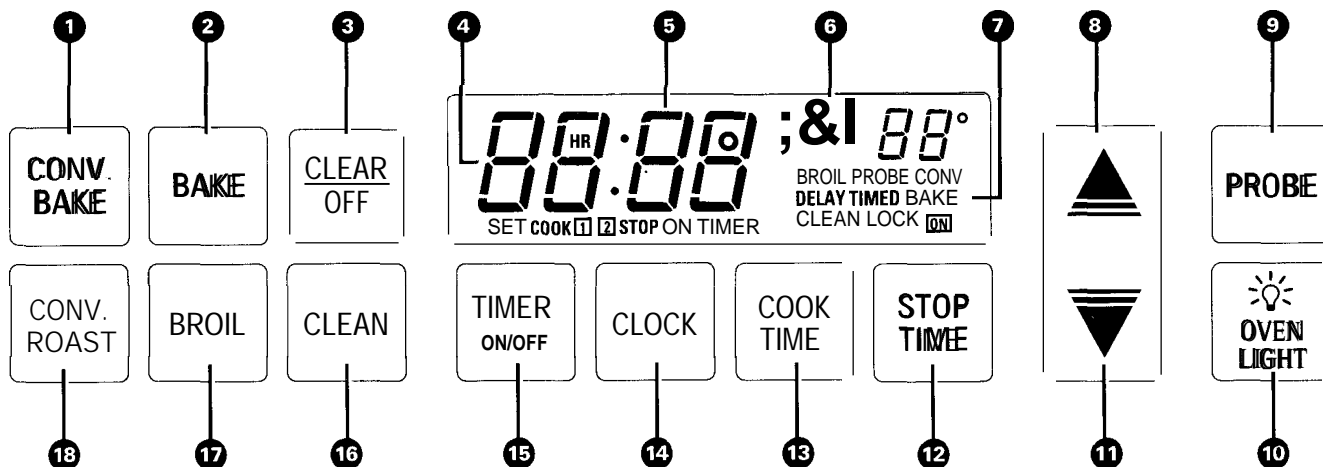

- 1. CONV. BAKE.** Press this pad to select baking with convection.
- 2. BAKE.** Press this pad to select the bake function.
- 3. CLEAR/OFF.** Press this pad to cancel all oven operations except clock and timer.
- 4. PROGRAM STATUS.** Words light up in the display to indicate what is in the time display. Programmed information can be displayed at any time by pressing the pad of the operation you want to see. For example, you can display the current time of day while the timer is counting down by pressing the CLOCK pad.
- 5. TIME DISPLAY.** Shows the time of day, the times set for the timer or automatic oven operation.
- 6. OVEN OR PROBE TEMPERATURE AND BROIL DISPLAY.** Shows the oven temperature, probe temperature or broil setting.
- 7. FUNCTION INDICATORS.** Lights up to show whether the oven is in the bake, broil, convection bake, self-clean mode, the set mode or the probe is selected.
- 8. INCREASE.** Short taps to this pad increase time or temperature by small amounts. Press and hold pad to increase time or temperature by larger amounts.
- 9. PROBE.** Press this pad when using the probe to cook food.
- 10. OVEN LIGHT.** Press this pad to turn the oven light on or off.
- 11. DECREASE.** Short taps to this pad decrease the time or temperature by small amounts. Press and hold pad to decrease the time or temperature by larger amounts.
- 12. STOP TIME.** Use this pad along with the COOK TIME or CLEAN pad to set the oven to start and stop automatically at a time you select.
- 13. COOK TIME.** Use this pad for Timed Bake, Timed Convection Bake and Timed Convection Roast operations.
- 14. CLOCK.** Press this pad to display or set the time of day.
- 15. TIMER ON/OFF.** Press this pad to select the timer function. The timer does not control oven operations. The timer can time up to 9 hours and 55 minutes.
- 16. CLEAN.** Press this pad to select the self-cleaning function. See the Operating the Self-Cleaning Oven section.
- 17. BROIL.** Press this pad to select the broil function.
- 18. CONV. ROAST.** Press this pad to select roasting with convection.

**If "F-" and a number flash in the display and the oven control signals, this indicates function error code. Press the CLEAR/OFF pad. Allow the oven to cool for 1 hour. Put the oven back into operation. If the function error code repeats, disconnect the power to the oven and call for service.**

# OVEN CONTROL, CLOCK AND TIMER



## Jock

The clock must be set for the automatic oven timing functions to work properly. The time of day cannot be changed during a Timed Bake or CLEAN cycle.

## To Set the Clock



1. Press the  
CLOCK pad.



2. Press the  
INCREASE or  
DECREASE pad  
to set the time  
of day.

3. Press the CLOCK pad to start.

## Timer

The timer is a minute timer; it does not control oven operations. The maximum setting on the timer is 9 hours and 55 minutes.

## To Set the Timer



1. Press the TIMER  
ON/OFF pad.

2. Press the INCREASE or  
DECREASE pad to set the  
amount of time on timer.

The timer will start automatically within a few seconds of releasing the INCREASE or DECREASE pad.

The timer, as you are setting it, will display hours and minutes; "HR" will be in the display.

During the countdown, when the timer reaches the last minute, the display will change to seconds only and a single beep will sound.

## Reset the Timer

If "TIMER" is flashing, press the INCREASE or DECREASE pad until the desired time is reached.

If "TIMER" is not flashing, press the TIMER ON/OFF pad first, then follow the instructions above to set the timer.

## To Cancel the Timer

Press the TIMER ON/OFF pad while the word "TIMER" is flashing.

## End of Cycle Tone

The end of cycle tone is a series of 3 beeps followed by 1 beep every 6 seconds. If you would like to remove the signal that beeps every 6 seconds, press and hold the CLEAR/OFF pad for 10 seconds.

To return the signal that beeps every 6 seconds, press and hold the CLEAR/OFF pad for 1 () seconds.

## Power Outage

After a power outage, when power is restored, the display will flash and time shown will no longer be correct—for example, after a 5-minute power interruption the clock will be 5 minutes slow.

other functions that were in operation when the power went out will have to be programmed again.

*(continued next page)*



# OVEN CONTROL, CLOCK AND TIMER

(continued)

## Display Messages

Programmed information can be displayed at any time by pressing the pad of the operation you want to see. For example, you can display the current time of day while the timer is counting down by pressing the CLOCK pad. Press the TIMER ON/OFF pad to return to the timer display.

**To check the start time for delayed Bake or Self-Clean, press and hold COOK TIME or CLEAN pad for 3 seconds.** The display will show the bake or clean start time for as long as you press the pad. When you release the pad, the display will return to the time of day.

If “door” appears in the display, LOCK flashes, and the oven control signals, you set the self-clean cycle and did not shut the oven door.

---

## INCREASE and DECREASE Pad Speed

You can change the speed of the INCREASE and DECREASE pads.

While the oven is off and the time of day shows in the display, press and hold the INCREASE and DECREASE pads and the TIMER ON/OFF pad at the same time for about 2 or 3 seconds.

A number from 1 to 5 will replace “0:00” in the display. The slowest is 1 and the fastest is 5. Use the INCREASE or DECREASE pad to change the number, then press the CL. EAR/OFF pad to return to the time of day display.

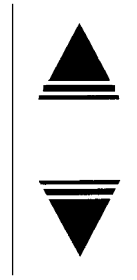

---

## Child Lockout Feature

Your built-in oven has a provision for locking the control panel to prevent the oven from being turned on accidentally.

**To lock the control panel,** press and hold the INCREASE and DECREASE pad and the STOP TIME pad at the same time for 2 seconds. The word “OFF” will appear and then disappear in the display and the control panel will be locked. During lockout, the word “OFF” will appear momentarily each time a cooking function pad is pressed.

**To unlock the control panel,** repeat the above procedure. The word “OFF” will appear in the display and then disappear after 2 seconds.

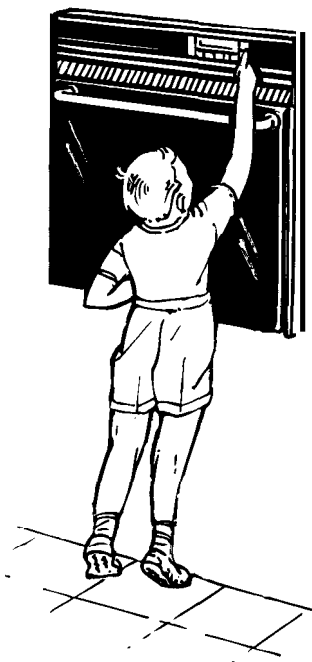



# USING YOUR OVEN



## Before Using Your Oven

1. Look at the controls. Be sure you understand how to set them properly. Read over the directions for the Oven Controls so you understand how to use them.
2. Check the inside of the oven. Look at the shelves. Take a practice run at removing and replacing them properly, to give sure, sturdy support.
3. Read over the information and tips that follow.

4. Keep this guide handy so you can refer to it, especially during the first weeks of using your new oven.

**NOTE:** You may notice a “burning” or “oily” smell the first few times you turn your oven on. This is normal in a new oven and will disappear in a short time. To speed the process, set a self-clean cycle for a minimum of 3 hours. See the Operating the Self-Cleaning Oven section.

## Oven Shelves

The shelves are designed with stop-locks so that when placed correctly on the shelf supports, they will stop before coming completely out from the oven, and will not tilt when removing food from or placing food on them.

When placing cookware on a shelf, pull the shelf out to the “stop” position. Place the cookware on the shelf, then slide the shelf back into the oven. This will eliminate reaching into the hot oven.

To remove the shelf from the oven, pull it forward to the stop-locks and lift the front of the shelf. Be certain that the shelf is cool before touching it.

To replace the shelf in the oven, tilt the shelf up at the front and slide the curved extension of the shelf under the stop-locks on the shelf supports. Then slide the shelf all the way into the oven.

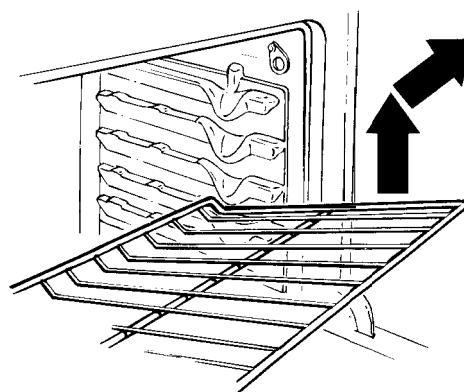

## Offset Shelf

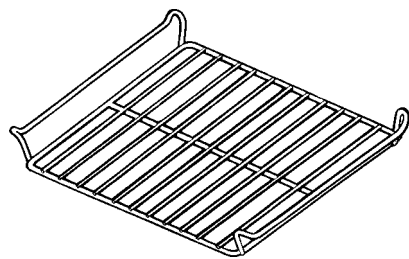

The offset shelf provides more cooking space between itself and the shelf above it. This allows more flexibility when placing foods in the oven. See the Multi-Shelf Baking section.

The offset shelf can be placed at any shelf position.

To remove the shelf, pull it forward to the stop-locks and lift the front of the shelf.

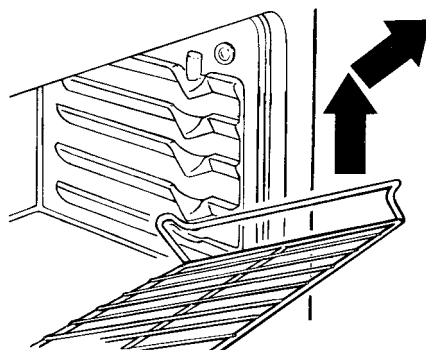

To replace the shelf, tilt the shelf up at the front and slide the curved extension of the shelf under the stop-locks on the shelf supports. Then slide the shelf all the way into the oven.

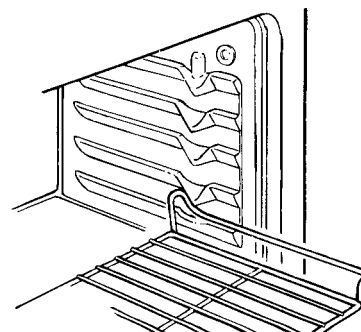

(continued next page)



# USING YOUR OVEN

(continued)

## Shelf Positions

The oven has 4 shelf supports identified in this illustration as A (bottom), B, C and D (top).

Shelf positions are suggested in the Baking, Roasting and Broiling sections.

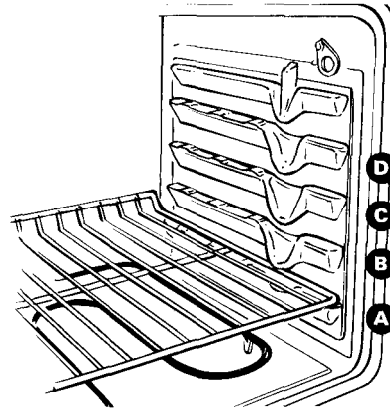

## Oven Light

The light comes on automatically when the door is opened.

Use the pad on the control panel to turn the light on and off when the door is closed.



# CONVECTION COOKING

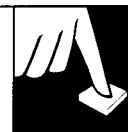

## What is Convection?

**In a convection oven**, a fan circulates hot air over, under and around the food. This circulating hot air is evenly distributed throughout the oven cavity. As a result, foods are evenly cooked and browned—often in less time with convection heat.

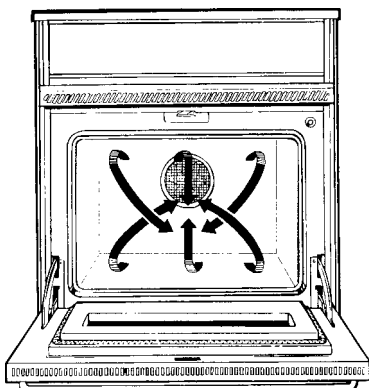

Because food is heated faster in a convection oven when using the convection modes, many types of food can be cooked at lower temperatures than those suggested for regular ovens. Do remember that recipe books often give times and temperatures for cooking in regular ovens. Convection ovens make it possible to reduce the temperature by 25°F. For more information on adapting recipes, see the Convection Cookbook.

**CAUTION:** The convection oven fan shuts off when the oven door is opened. **DO NOT** leave the door open for long periods of time while using convection cooking or you may shorten the life of the convection heating element.

## When should you use Convection Bake or Convection Roast?

To help you understand the difference between convection bake and roast and traditional bake and roast, here are some general guidelines.

**In convection bake**, heat comes from the heating element in the rear of the oven. The convection fan circulates the heated air evenly, over and around the food. Preheating is not necessary with foods having a bake time of over 15 minutes.

**In regular baking**, the bottom oven unit heats the air in the oven which then cooks the food.

### Convection Bake

- Ideal for evenly browned baked foods cooked on all 3 shelves.
- Good for large quantities of baked foods.
- Good results with cookies, biscuits, muffins, brownies, cupcakes, cream puffs, sweet rolls, angel food cake and bread.

### Regular Bake

- Foods such as layer cakes have a more level top crust when not baked with convection heat.

**In convection roast**, heat comes from the top oven unit. The convection fan circulates the heated air evenly over and around the food. Meat and poultry are browned on all sides as if they were cooked on a rotisserie. Using the roasting rack provided, heated air will be circulated over, under and around the food being roasted. The heated air seals in juices quickly for a moist and tender product while, at the same time, creating a rich golden brown exterior.

### Convection Roast

- Large tender cuts of meat, uncovered.
- Roasting pans with low sides to allow air movement around food.

### Regular Roast

- Less tender cuts of meat because these need to cook a long time in liquid to become tender.
- Cooking bag
- Foil tent
- Covered dish

## Cookware for Convection Cooking

Before using your convection oven, check to see if your cookware leaves room for air circulation in the oven. If you are baking with several pans, leave space between them. Also, be sure the pans do not touch each other or the walls of the oven.

### Metal and Glass

Any type of cookware will work in your convection oven. However, metal pans heat the fastest and are recommended for convection baking.

- Darkened or matte-finished pans will bake faster than shiny pans.
- Glass or ceramic pans cook more slowly.

### Paper and Plastic

Heat-resistant paper and plastic containers that are recommended for use in regular ovens can be used in convection ovens. Plastic cookware that is heat-resistant to temperatures of 400°F. can also be used.

When baking cookies, you will get the best results if you use a flat cookie sheet instead of a pan with low sides.

For recipes like oven-baked chicken, you should use a pan with low sides. Hot air cannot circulate well around food in a pan with high sides.



# CONVECTION BAKING

## Adapting Recipes for Convection Baking

As a general rule, reduce the temperature by 25°F. for Convection Baking. For more specific instructions, follow the guidelines in the Convection Cookbook.

Preheating is not necessary with foods having a bake time of over 15 minutes.

Check foods for doneness at the minimum suggested cooking time.

Use pan size recommended in the recipe.

For more information on adapting recipes, see the Convection Cookbook.

## Multi-Shelf Baking

Because heated air is circulated evenly throughout the oven, foods can be baked with excellent results on 2 or 3 shelves at a time. Multi-shelf baking may increase cook times slightly for some foods but the overall result is time saved. Cookies, muffins, biscuits, and other quickbreads give very good results with multi-shelf baking.

**When baking on 3 shelves,** divide the oven into thirds by placing the offset shelf in the third (C) shelf position and straight shelves in first (A) and fourth (D) shelf position.

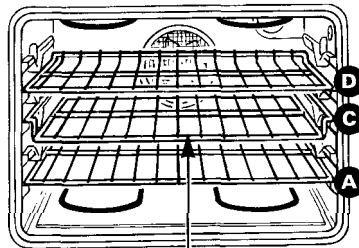

Offset Shelf

**For 2-shelf baking,** place the offset shelf in the bottom (A) shelf position. Place the straight shelf in the third (C) shelf position.

**CAUTION:** When you are using the offset shelf in the lowest position (A), you will need to use caution when pulling the shelf out. We recommend that you pull the shelf out several inches and then, using 2 pot holders, pull the shelf out by holding the sides of it. The offset shelf is low and you could be burned if you place your hand in the middle of the shelf and pull all the way out.

**NOTE:** When convection baking with only 1 shelf, follow the shelf positions recommended in Oven Shelves in the Baking section.

## How to Set Your Oven for Convection Baking

**To avoid possible burns,** place the shelves in the correct position before you turn the oven on.



1. Press the CONV. BAKE pad.

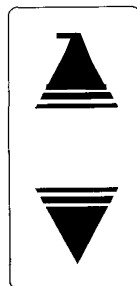

2. Press the INCREASE or DECREASE pad. The last oven set temperature appears in the display. Continue pressing until the desired temperature is displayed.

The oven will start automatically. The word "ON" and "100°" will be displayed. As the oven heats up, the display will show the changing temperatures.



3. Press the CLEAR/OFF pad when baking is finished.

**NOTE:** You will hear a fan while cooking with this feature. The fan will stop when the door is opened, but the heat will not turn off.

**To change the oven temperature during the Convection Bake cycle,** press the CONV. BAKE pad and then the INCREASE or DECREASE pad to get the new temperature.

# TIMED CONVECTION BAKING



## How to Convection Time Bake

Your oven can be set to turn on and off automatically.

**NOTE:** Before beginning, make sure the oven clock shows the correct time of day.

**CLOCK**

**To set the clock,** first press the **CLOCK** pad. Press the **INCREASE** or **DECREASE** pad until the correct time of day is displayed. Press the **CLOCK** pad to start.

## How to Set Immediate Start and Automatic Stop Convection Bake

To **avoid possible burns**, place the oven shelves in the correct position before you turn the oven on.

The oven will turn on immediately and cook for a specific length of time. At the end of Cook Time, the oven will turn off automatically.

**CONV.  
BAKE**

1. Press the **CONV. BAKE** pad.



2. Press the **INCREASE** or **DECREASE** pad until the desired temperature is displayed.



**COOK  
TIME**

3. Press the **COOK TIME** pad.

**NOTE:** If your recipe requires preheating, you may need to add additional time to the length of the Cook Time.

4. Press the **INCREASE** pad until the desired length of baking time appears in the display. The minimum Cook Time you can set is 10 minutes.

The words “**TIMED CONV BAKE**” and “**COOK TIME**” will be displayed along with the oven temperature that you set and the cook time that you entered. The oven will start automatically. The word “**ON**” and “**100**” will be displayed. The Cook Time will begin to count down. As the oven heats up, the display will show the changing temperatures. When the oven reaches the temperature you set, a tone will sound. The oven will continue to cook for the programmed amount of time, then shut off automatically.

5. At the end of Timed Convection Bake, the display will show “**OHR:OO COOK TIME**” and the oven will turn off. The end of cycle tone will sound.

**CLEAR  
OFF**

6. Press the **CLEAR/OFF** pad to clear the display if necessary. Remove the food from the oven. Remember, foods that are left in the oven continue cooking after the controls are off.

**NOTE:**

- You will hear a fan while cooking with this feature. The fan will stop when the door is opened but the heat will not turn off.
- Foods that spoil easily such as milk, eggs, fish, stuffings, poultry and pork should not be allowed to sit for more than 1 hour before or after cooking. Room temperature promotes the growth of harmful bacteria. Be sure that oven light is off because heat from the bulb will speed harmful bacteria growth.

*(continued next page)*



# TIMED CONVECTION BAKING

(continued)

## How to Set Delay Start and Automatic Stop Convection Bake

### Quick Reminder

1. Press the CONV. BAKE pad.
2. Press the INCREASE or DECREASE pad to select the oven temperature.
3. Press the COOK TIME pad.
4. Press the INCREASE or DECREASE pad to set the length of Cooking Time.
5. Press the STOP TIME pad.
6. Press the INCREASE or DECREASE pad until the desired Stop Time appears in the display.

**To avoid possible burns,** place the shelves in the correct position before you program the oven.

You can set the oven control to turn the oven on automatically, cook for a specific length of time and turn off automatically.

**For example:** Let's say it's 2:00 and dinner time is shortly after 7:00. The recipe suggests 3 hours baking time at 325°F. Here's how:



1. Press the CONV. BAKE pad.

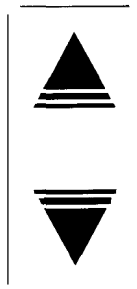

2. Press the INCREASE or DECREASE pad until "325°" is displayed.



3. Press the COOK TIME pad.

**NOTE:** If your recipe requires preheating, you may need to add additional time to the length of the Cook Time.

4. Press the INCREASE pad until "3HR:00" appears in the display. Cook Time of 3 hours now appears in the display.



5. Press the STOP TIME pad. "SET STOP TIME" and the earliest Stop Time you can set appear in the display. In this example, "5:00" and "COOK STOP TIME" appear in the display.

The control automatically sets the Stop Time by adding the Cook Time to the time of day. In this example, the time of day is 2:00 and the Cook Time is 3 hours. Adding 3 hours to the time of day equals 5:00.



6. Change Stop Time from 5:00 to 7:00 by pressing the INCREASE pad until "7:00" appears in the display. The words "DELAY TIMED CONV BAKE" and "STOP TIME" appear in the display.

At 4:00, the oven will turn on automatically. The word "ON" and "100°" will be displayed. The Cook Time will begin to count down. As the oven heats up, the display will show the changing temperatures. The oven will continue to cook for the programmed 3 hours and shut off automatically at 7:00.

7. At the end of Timed Convection Bake, the display will show "OHR:OO COOK TIME" and the oven will turn off. The end of cycle tone will sound.



8. Press the CLEAR/OFF pad to clear the display if necessary. Remove the food from the oven. Remember, even though the oven shuts off automatically, foods continue cooking after the controls are off.

### NOTE:

- You will hear a fan while cooking with this feature. The fan will stop when the door is opened but the heat will not turn off.
- Foods that spoil easily such as milk, eggs, fish, stuffings, poultry and pork should not be allowed to sit for more than 1 hour before or after cooking. Room temperature promotes the growth of harmful bacteria. Be sure that the oven light is off because heat from the bulb will speed harmful bacteria growth.

# CONVECTION ROASTING



Meats cooked in a convection oven are dark brown on the outside and tender and juicy on the inside. In most cases, cooking time will be less when using the Convection Roast feature. Sometimes cooking time is reduced by 10 minutes per hour.

To make sure the meat is cooked the way you want it, we recommend using the temperature probe provided with the oven.

The special roasting rack and pan allow heated air to circulate over and under the meat. This allows the meat to brown on all sides.

## Adapting Recipes for Convection Roasting

Use the temperature recommended in the Convection Roasting Guide.

Preheating is not necessary.

Check foods for doneness at the minimum suggested time.

Use the special roasting rack with the broiler pan and grid.

For more information on adapting recipes, see the Convection Cookbook.

## Convection Roasting Rack

Roasts or poultry should be cooked on the lowest shelf position (A) on the offset shelf.

When you are convection roasting you will use the broiler pan and grid and the special roasting rack.

**The pan is used to catch grease spills and the grid is used to prevent grease splatters. The rack holds the meat.**

**This rack allows the heated air to circulate under the meat and increase browning on the underside of the meat or poultry.**

1. Place the offset shelf in the lowest shelf position (A).

**CAUTION:** When you are using the offset shelf in the lowest position (A), you will need to use caution when pulling the rack out. We recommend that you pull the shelf out several inches and then, using 2 pot holders, pull the shelf out by holding the sides of it. The shelf is low and you could be burned if you place your hand in the middle of the shelf and pull all the way out.

2. Place the broiler pan and grid on the roasting stand. Place the roasting rack on the stand.

3. Place the meat on the special roasting rack.

See the Convection Roasting with the Probe section to insert the probe correctly.

**NOTE:** It is important that the broiler pan and grid be used with the roasting rack and stand for best convection roasting results.

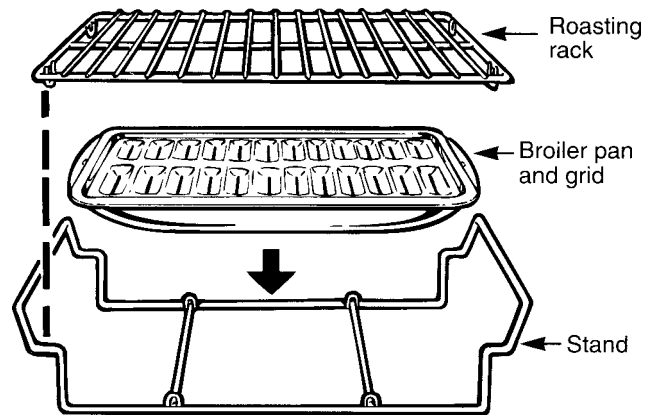

(continued next page)



# CONVECTION ROASTING

(continued)

## How to Set Your Oven for Convection Roasting When Using the Temperature Probe

**NOTE:** For best results when roasting large turkeys and roasts, we recommend using the probe included in the convection oven.

The display will flash “PROBE” and the oven control will signal if the probe is inserted into the outlet, but the oven is not programmed for the probe.

1. Place the offset shelf in the lowest position (A). Insert the probe into the meat.
2. Plug the probe into the outlet on the oven wall. Make sure it is pushed all the way in. Close the oven door.

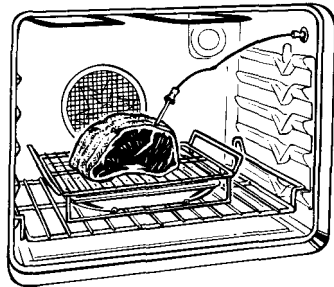

PROBE pad.



press the

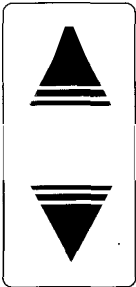

4. Press the INCREASE or DECREASE pad until the desired internal probe temperature is displayed.



5. Press the CONV. ROAST pad.

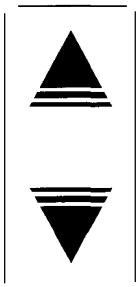

6. Press the INCREASE or DECREASE pad. The last oven set temperature appears in the display. Continue pressing until the desired temperature is displayed.

When the oven starts to heat, the words “CONV ON” and the roasting temperature you set will be in the display.

After a few seconds, the words “LO PROBE” will replace the roasting temperature in the display. After the internal temperature of the meat reaches 100°F., the changing internal temperature will be shown in the display.



7. When the internal temperature of the meat reaches the number you have set, the probe and the oven turn off and the oven control signals. To stop signal, press the CLEAR/OFF pad. Use hot pads to remove the probe from the food. Do not use tongs to pull on it—they might damage it.

**CAUTION:** To prevent possible burns, do not unplug the probe from the oven outlet until the oven has cooled. Do not store the probe in the oven.

**NOTE:**

- If the probe is removed from the food before the final temperature is reached, a tone will sound and the display will flash until the probe is removed from the oven.
- You will hear a fan while cooking with this feature. The fan will stop when the door is opened but the heat will not turn off.
- You can use the timer even though you can not use timed oven operations.

**To change the oven temperature during the Convection Roast cycle,** press the CONV. ROAST pad and then press the INCREASE or DECREASE pad to get the new desired temperature.



# CONVECTION ROASTING GUIDE



Meats.			Minutes/Lb.	Oven Temperature (°F.)	Internal Temperature (°F.)
Beef	<b>Rib, Boneless Rib,</b>	Rare	<b>20-24</b>	<b>325°</b>	140°†
	<b>Top Sirloin</b> (3 to 5 lbs.)	Medium	24-28	325°	160°
		Well	<b>28-32</b>	<b>325°</b>	<b>170°</b>
	<b>Beef Tenderloin</b>	Rare	<b>10-14</b>	<b>325°</b>	140°†
		Medium	14-18	325°	160°
	<b>Pot Roast</b> (2½ to 3 lbs.)	Chuck, Rump	35-45	300°*	170°
Pork	<b>Bone-in, Boneless</b> (3 to 5 lbs.)		23-27	325°	170°
	<b>Chops</b>	2 chops	<b>30-35</b> total	325°	170°
	(1/2 to 1 -inch thick)	4 chops	35-40 total	325°	170°
		6 chops	40-45 total	325°	170°
Ham	<b>Canned, Butt, Shank</b> (3 to 5 lbs. fully cooked)		14-18	325°	140°
Lamb	<b>Bone-in, Boneless</b>	Medium	17-20	325°	160°
	(3 to 5 lbs.)	Well	20-24	325°	170°
Seafood	<b>Fish, whole</b> (3 to 5 lbs.)		30-40 total	<b>400°</b>	
	<b>Lobster Tails</b> (6 to 8 oz. each)		20-25 total	350°	
Poultry	<b>Whole Chicken</b>		<b>24-26</b>	<b>350°</b>	180°-185°
	(2½ to 3½ lbs.)				
	<b>Cornish Hens</b>	Unstuffed (1 to 1½ lbs.)	50-55 total	350°	180°-185°
		Stuffed (1 to 1½ lbs.)	55-60 total	<b>350°</b>	180°-185°
	<b>Duckling</b> (4 to 5 lbs.)		24-26	325°	180°-185°
	<b>Turkey, whole*</b>	Unstuffed (10 to 16 lbs.)	8-11	325°	180°-185°
	Unstuffed (18 to 24 lbs.)	7-10	325°	180°-185°	
	<b>Turkey Breast</b> (4 to 6 lbs.)		16-19	325°	170°

\*Stuffed birds generally require 30-45 minutes additional roasting time, Shield legs and breast with foil to prevent over browning and drying of skin.

†The U. S. Department of Agriculture says "Rare beef is popular, but you should know that cooking it to only 140°F. means some food poisoning organisms may survive." (Source: Safe Food Book, Your Kitchen Guide, USDA Rev. June 1985.)

## REGULAR BAKING

**NOTE:** When the oven is hot, the front of the oven gets hot too.

Your oven temperature is controlled very accurately using an oven control system. We recommend that you operate the oven for a number of weeks to become familiar with your new oven's performance. If you think an adjustment is necessary, see the Adjust the Oven Thermostat section. It gives easy *Do It Yourself* instructions on how to adjust the thermostat.

### How to Set Your Oven for Baking

To avoid possible burns, place the shelves in the correct position before you turn the oven on.



1. Press the **BAKE** pad.



3. Press the **CLEAR/OFF** pad when baking is finished and then remove the food from the oven.

2. Press the **INCREASE** or **DECREASE** pad. The last oven set temperature appears in the display. Continue pressing until the desired temperature is displayed.

**To change the oven temperature during the BAKE cycle, press the BAKE pad and then the INCREASE or DECREASE pad to get the new temperature.**

The oven will start automatically. The word "ON" and "100°" will be displayed. As the oven heats up, the display will show the changing temperatures. When the oven reaches the temperature you set, a tone will sound.

(continued next page)



## REGULAR TIMED BAKING

### How to Time Bake

Your oven can be set to turn on and off automatically.

NOTE: Before beginning, make sure the oven clock shows the correct time of day.

CLOCK

**To set the clock**, first press the CLOCK pad. Press the INCREASE or DECREASE pad until the correct time of day is displayed. Press the CLOCK pad to start.

### How to Set Immediate Start and Automatic Stop

**To avoid possible burns**, place the shelves in the correct position before you turn the oven on.

The oven will turn on immediately and cook for a selected length of time. At the end of Cook Time, the oven will turn off automatically.



1. Press the BAKE pad.

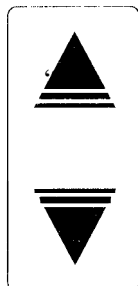

2. Press the INCREASE or DECREASE pad until the desired temperature is displayed.



3. Press the COOK TIME pad.  
**NOTE:** If your recipe requires preheating, you may need to add additional time to the length of the Cook Time.

4. Press the INCREASE or DECREASE pad until the desired length of baking time is displayed.

The words "TIMED BAKE" and "COOK TIME" will be displayed along with the oven temperature that you set and the cook time that you entered. The oven will start automatically. The word "ON" and "100°" will be displayed. The Cook Time will begin to count down. As the oven heats up, the display will show the changing temperatures. When the oven reaches the temperature you set, a tone will sound. The oven will continue to cook for the programmed amount of time, then shut off automatically.

5. At the end of Timed Bake, the display will show "OHR:OO COOK TIME" and the oven will turn off. The end of cycle tone will sound.

6. Press the CLEAR/OFF pad to clear the display if necessary. Remove the food from the oven. Remember, foods that are left in the oven continue cooking after the controls are off.

**NOTE:** Foods that spoil easily such as milk, eggs, fish, stuffings, poultry and pork should not be allowed to sit for more than 1 hour before or after cooking. Room temperature promotes the growth of harmful bacteria. Be sure that oven light is off because heat from the bulb will speed harmful bacteria growth.



## How to Set Delay Start and Automatic Stop

### Quick Reminder

1. Press the BAKE pad.
2. Press the INCREASE or DECREASE pad to select the oven temperature.
3. Press the COOK TIME pad.
4. Press the INCREASE or DECREASE pad to set the length of Cooking Time.
5. Press the STOP TIME pad.
6. Press the INCREASE or DECREASE pad until the desired Stop Time appears in the display.

**To avoid possible burns,** place the shelves in the correct position before you program the oven.

You can set the oven control to turn the oven on automatically, cook for a specific length of time and turn off automatically.

**For example:** Let's say it's 2:00 and dinner time is shortly after 7:00. The recipe suggests 3 hours baking time at 325°F. Here's how:



1. Press the BAKE pad.

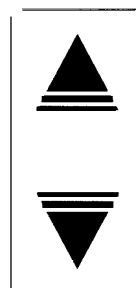

2. Press the INCREASE or DECREASE pad until "325.0" is displayed.



3. Press the COOK TIME pad.

**NOTE:** If your recipe requires preheating, you may need to add additional time to the length of the Cook Time.

4. Press the INCREASE pad until "3HR:00" appears in the display. A Cook Time of 3 hours now appears in the display.



5. Press the STOP TIME pad. "SET STOP TIME" and the earliest Stop Time you can set appear in the display. In this example, "5:00" and "COOK STOP TIME" appear in the display.

The control automatically sets the Stop Time by adding the Cook Time to the time of day. In this example, the time of day is 2:00 and the Cook Time is 3 hours. Adding 3 hours to the time of day equals 5:00.

6. Change the Stop Time from 5:00 to 7:00 by pressing the INCREASE pad until "7:00" and the Stop Time appear in the display. The words "DELAY TIMED BAKE" appear in the display.

At 4:00, the oven will turn on automatically. The word "ON" and "100°" will be displayed. The Cook Time will begin to count down. As the oven heats up, the display will show the changing temperatures. The oven will cook for the programmed 3 hours and shut off automatically at 7:00.

7. At the end of Timed Bake, the display will show "OHR:00 COOK TIME" and the oven will turn off. The end of cycle tone will sound.
8. Press the CLEAR/OFF pad to clear the display if necessary. Remove the food from the oven. Remember, even though the oven shuts off automatically, foods continue cooking after the controls are off.

**NOTE:** Foods that spoil easily such as milk, eggs, fish, stuffings, poultry and pork should not be allowed to sit for more than 1 hour before or after cooking. Room temperature promotes the growth of harmful bacteria. Be sure that the oven light is off because heat from the bulb will speed harmful bacteria growth.

*(continued next page)*



# REGULAR BAKING

(continued)

## Oven Shelves

Arrange the oven shelf or shelves in the desired locations while the oven is cool. The correct shelf position depends on the kind of food and the browning desired.

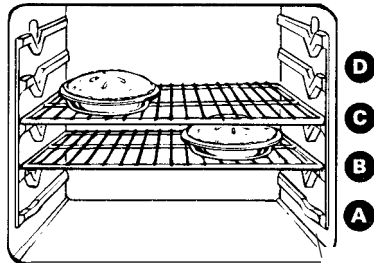

As a general rule, place most foods in the middle of the oven, on either shelf positions B or C. See the chart for suggested shelf positions.

Type of Food	Shelf Position
Angel food cake	A
Biscuits or muffins	B or C
Cookies or cupcakes	B or C
Brownies	B or C
Layer cakes	B or C
Bundt or pound cakes	A, or B
Pies or pie shells	B or C
Frozen pies	A (on cookie sheet)
Casseroles	B or C
Roasting	A or B

## Preheating

Preheat the oven if the recipe calls for it. Preheat means bringing the oven up to the specified temperature before putting in the food. To preheat, set the oven at the correct temperature—selecting a higher temperature does not shorten preheat time.

Preheating is necessary for good results when baking—cakes, cookies, pastry and breads. For most casseroles and roasts, preheating is not necessary. For ovens without a preheat indicator light or tone, preheat 10 minutes. After the oven is preheated, place the food in the oven as quickly as possible to prevent heat from escaping.

## Baking Pans

Use the proper baking pan. The type of finish on the pan determines the amount of browning that will occur.

- Dark, rough or dull pans absorb heat, resulting in a browner, crisper crust. Use this type for pies.
- Shiny, bright and smooth pans reflect heat, resulting in a lighter, more delicate browning. Cakes and cookies require this type of pan.
- Glass baking dishes also absorb heat. When baking in glass baking dishes, the temperature may need to be reduced by 25°F, depending on the food that is being cooked. This is not necessary when baking pies or casseroles. Use the recommended cooking time in the recipe.

## Pan Placement

For even cooking and proper browning, there must be enough room for air circulation in the oven. Baking results will be better if baking pans are centered as much as possible rather than being placed to the front or to the back of the oven.

Pans should not touch each other or the walls of the oven. Allow 1- to 1 ½-inch space between pans as well as from the back of the oven, the door and the sides. If you use two shelves, stagger the pans so one is not directly above the other.



## Baking Guides

When using prepared baking mixes, follow package recipe or instructions for the best baking results.

### Cookies

When baking cookies, flat cookie sheets (without sides) produce better-looking cookies. Cookies baked in a jelly roll pan (short sides all around) may have darker edges and pale or light browning may occur.

Do not use a cookie sheet so large that it touches the walls or the door of the oven. Never entirely cover a shelf with a large cookie sheet.

For best results during regular baking, use only 1 cookie sheet in the oven at a time on shelf at either position B or C. Also see the Multi-Shelf baking section.

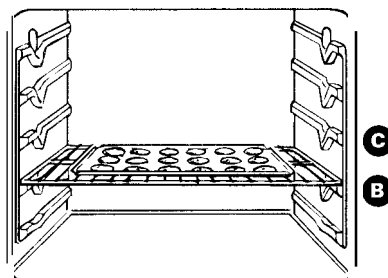

### Pies

For best results, bake pies in dark, rough or dull pans, to produce a browner, crisper crust. Frozen pies in foil pans should be placed on an aluminum cookie sheet for baking since the shiny foil pan reflects heat away from the pie crust; the cookie sheet helps retain it.

### Cakes

When baking cakes, warped or bent pans will cause uneven baking results and poorly shaped products. A cake baked in a pan larger than the recipe recommended will usually be crisper, thinner and drier than it should be. If baked in a pan smaller than recommended, it may be undercooked and batter may overflow. Check the recipe to make sure the pan size used is the one recommended.

### Aluminum Foil

Never cover a shelf entirely with aluminum foil. This will disturb the heat circulation and result in poor baking. A smaller sheet of foil may be used to catch a spillover by placing it on a lower shelf several inches below the food.

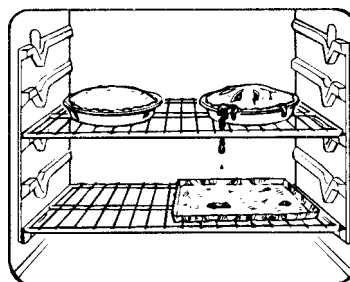

### Don't Peek

Set the timer for the estimated cooking time and do not open the door to look at your food. Most recipes provide minimum and maximum baking times such as "bake 30-40 minutes."

DO NOT open the door to check until the minimum time. Opening the oven door frequently during cooking allows heat to escape and makes baking times longer. Your baking results may also be affected.



## ADJUST THE OVEN THERMOSTAT

*(Do It Yourself!)*

**You may feel that your new oven cooks differently than the one it replaced.** We recommend that you use your new oven for a few weeks to become more familiar with it, following the times given in your recipes as a guide.

**If you think your new oven is too hot or too cold, you can adjust the thermostat yourself.** If you think it is too hot, adjust the thermostat to make it cooler. If you think it is too cool, adjust the thermostat to make it hotter.

**We do not recommend the use of inexpensive thermometers,** such as those found in grocery stores, to check the temperature setting of your new oven. These thermometers may vary 20-40 degrees.

**The thermostat adjustment for Bake does not affect Convection Bake or Convection Roast.**

To adjust these, press the CONVECTION BAKE or the CONVECTION ROAST pad instead of the BAKE pad when following the steps under To Adjust the Thermostat.

### To Adjust the Thermostat:

1. Press the BAKE pad.

**BAKE**

2. Select an oven temperature between 500°F and 550°F.
3. Immediately, before “ON” appears, press and hold the BAKE pad for about 4 seconds. The time display will change to the oven adjustment display.
4. The oven temperature can be adjusted up to (+) 35°F. hotter or (-) 35°F. cooler. Use the INCREASE or DECREASE pad to select the desired change in the display.

**CLEAR  
OFF**

5. When you have made the adjustment, press the CLEAR/OFF pad to go back to the time of day display. Use your oven as you would normally.

**NOTE:** This adjustment will not affect the Broil or Clean temperatures. It will be retained in memory – after a power failure.

# REGULAR ROASTING



Roasting is cooking by dry heat. Tender meat or poultry can be roasted uncovered in your oven. Roasting temperatures, which should be low and steady, keep spattering to a minimum.

Roasting is really a baking procedure used for meats. Therefore, oven controls are set for BAKE or Timed Baking. (You may hear a slight clicking sound, indicating the oven is working properly.) Roasting is easy; just follow these directions:

1. Place the shelf in A or B position. No preheating is necessary.
2. Check the weight of the meat. Place it fat side up (or for poultry breast-side-up), on a trivet in a shallow pan. The melting fat **will** baste the meat. Select a pan as close to the size of the meat as possible. (The broiler pan with grid is a good pan for this.) Line the broiler pan with aluminum foil when using the pan for marinating, cooking with fruits, cooking heavily cured meats, or basting food during cooking. Avoid spilling these materials inside the oven or inside the oven door.



3. Press the BAKE pad.

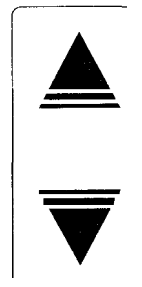

4. Press the INCREASE or DECREASE pad. The last oven set temperature appears in the display. Continue pressing the pad until the desired temperature is displayed.

The oven will start automatically. The word "ON" and "100°" will be displayed. As the oven heats up, the display will show the changing temperatures. When the oven reaches the temperature you set, a tone will sound.



5. Press the CLEAR/OFF pad when roasting is finished.

Most meats continue to cook slightly while standing, after being removed from the oven. Standing time recommended for roasts is 10 to 20 minutes. This allows roasts to firm up and makes them easier to carve. Internal temperature will rise about 5° to 10°F.; to compensate for temperature increase, if desired, remove the roast from the oven sooner (at 5° to 10°F. less than the temperature in the Regular Roasting Guide).

#### NOTE:

- You may wish to use Timed Baking, as described in the Baking section of this book, to turn the oven on and off automatically.
- Remember that food will continue to cook in the hot oven and therefore should be removed when the desired internal temperature has been reached.

**To change the oven temperature during roasting,** press the BAKE pad and then the INCREASE or DECREASE pad to get the new temperature.

## Frozen Roasts

Frozen roasts of beef, pork, lamb, etc., can be started without thawing, but allow 15 to 25 minutes per pound additional time (15 minutes per pound for roasts under 5 pounds, more time for larger roasts).

Thaw most frozen poultry before roasting to ensure even doneness. Some commercial frozen poultry can be cooked successfully without thawing. Follow the directions given on the package label.



# REGULAR ROASTING WITH THE PROBE

See the Regular Roasting Guide.

## Correct Placement of the Temperature Probe

A temperature probe has been provided for use in your new oven. This probe is designed to withstand high temperatures. Temperature probes provided with other products, such as those used for microwave ovens, may not be designed to withstand high temperatures. Use of probes other than the one provided with this product may result in damage to the probe.

Never leave your probe inside the oven during a self-cleaning cycle.

For many foods, especially roasts and poultry, internal food temperature is the best test for doneness. The temperature probe takes the guesswork out of roasting by cooking foods to the exact doneness you want. When the internal temperature of the food reaches the temperature you set, the oven automatically shuts off.

The temperature probe has a skewer-like probe at one end and a plug at the other end that goes into the outlet on the oven wall.

Use the handles of the probe and plug when inserting and removing them from the meat and wall outlet. Do not use tongs to pull on the cable when removing the probe—they might damage it. **TO AVOID BREAKING THE PROBE, MAKE SURE FOOD IS COMPLETELY DEFROSTED BEFORE INSERTING.**

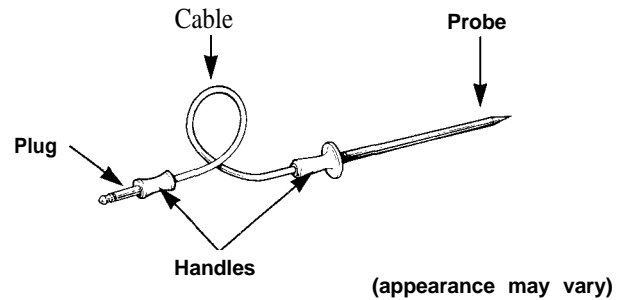

After preparing the meat and placing it on a trivet or on the broiler pan grid, follow these directions for proper probe placement.

1. Lay the probe on the outside of the meat along the top or side and mark with your finger where the edge of the meat comes to on the probe. The point should rest in the center of the thickest meaty part of the roast.

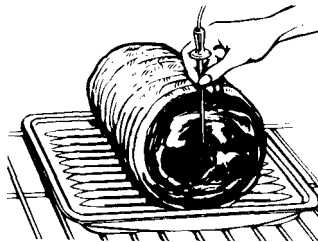

2. Insert the probe into the meat up to the point marked off with your finger. It should not touch the bone, fat or gristle.

*No more than 2 inches of the probe, not counting the handle, should be left exposed outside the meat.*

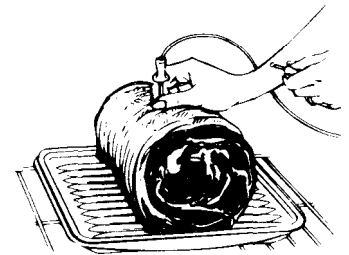

## Ham or Lamb

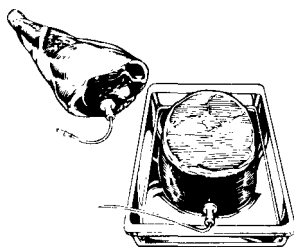

For roasts with no bone, insert the probe into the meatiest part of the roast. For bone-in ham or lamb, insert the probe into the center of the lowest large muscle or joint.

## Casseroles or Fish

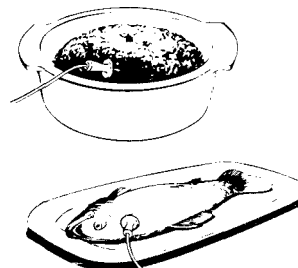

Insert the probe into the center of dishes such as meat loaf or casseroles. When cooking fish, insert the probe from just above the gill into the meatiest area, parallel to the backbone.

## Poultry

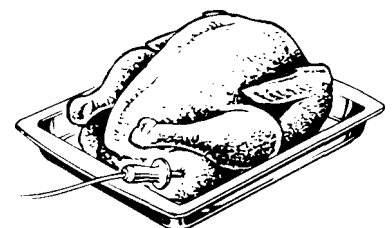

Insert the probe into the meatiest part of the inner thigh from below and parallel to the leg of a whole turkey.





## How to Set the Oven When Using the Temperature Probe

The display will flash “PROBE” and the oven control will signal if the probe is inserted into the outlet but the oven is not programmed for the probe.

1. Insert the probe into the meat.
2. Plug the probe into the outlet on the oven wall. Make sure it's pushed all the way in. Close the oven door.

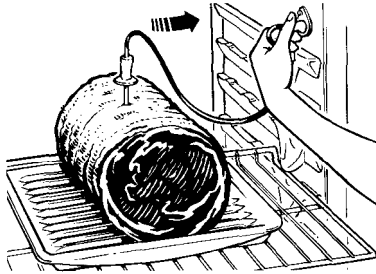

CLEAR  
OFF

7. When the internal temperature of the meat reaches the number you have set, the probe and the oven turn off and the oven control signals. To stop the signal, press the CLEAR/OFF pad. Use hotpads to remove the probe from the food. Do not use tongs to pull on it—they might damage it.

**CAUTION:** To prevent possible burns, do not unplug the probe from the outlet until the oven has cooled. Do not store the probe in the oven.

**NOTE:**

- If the probe is removed from the food before the final temperature is reached, a tone will sound and the display will flash until the probe is removed from the oven.
- You can use the timer even though you can not use timed oven operations.

PROBE

3. Press the PROBE pad.



4. Press the INCREASE or DECREASE pad until the desired internal probe temperature is displayed.



BAKE

5. Press the BAKE pad.

6. Press the INCREASE or DECREASE pad. The last oven set temperature appears in the display. Continue pressing the pad until the desired oven temperature is displayed.

The oven will start automatically. The words “BAKE ON” and the roasting temperature you set will be in the display.

After a few seconds, the words “LO PROBE” will replace the roasting temperature in the display. After the internal temperature of the meat reaches 100°F., the changing internal temperature will be shown in the display.

To change the oven temperature during the roast cycle, press the BAKE pad and then the INCREASE or DECREASE pad to get the new temperature.



# REGULAR ROASTING

## Questions and Answers

**Q. Is it necessary to check for doneness with a meat thermometer?**

**A.** Checking the finished internal temperature at the completion of cooking time is recommended if you did not use the probe while cooking. Temperatures are shown in the Roasting Guide. For roasts over 8 lbs., check with thermometer at half-hour intervals after half the cooking time has passed.

**Q. Why is my roast crumbling when I try to carve it?**

**A.** Roasts are easier to slice if allowed to cool 10 to 20 minutes after removing them from the oven. Be sure to cut across the grain of the meat.

**Q. Do I need to preheat my oven each time I cook a roast or poultry?**

**A.** It is rarely necessary to preheat your oven. Preheat only for very small roasts, which cook a short length of time.

**Q. When buying a roast, are there any special tips that would help me cook it more evenly?**

**A. Yes.** Buy a roast as even in thickness as possible, or buy rolled roasts.

**Q. Can I seal the sides of my foil "tent" when roasting a turkey?**

**A.** Sealing the foil will steam the meat. Leaving it unsealed allows the air to circulate and brown the meat.

## REGULAR ROASTING GUIDE

Type	Oven Temperature	Doneness	Approximate Roasting Time in Minutes per Pound		Internal Temperature 'F.
<b>Meat</b>			<b>3 to 5 lbs.</b>	<b>6 to 8 lbs.</b>	
Tender cuts; rib, high quality sirloin tip, rump or top round*	325°	Rare: Medium: Well Done:	24-33 35-39 40-45	18-22 22-29 30-35	140°-150°† 150°-160° 170°-185°
Lamb leg or bone-in shoulder*	325°	Rare: Medium: Well Done:	21-25 25-30 30-35	20-23 24-28 28-33	140°-150°† 150°-160° 170°-185°
Veal shoulder, leg or loin*	325°	Well Done:	35-45	30-40	170°-180°
Pork loin, rib or shoulder*	325°	Well Done:	35-45	30-40	170°-180°
Ham, precooked	325°	To Warm:	17-20 minutes per pound (any weight)		115°-120°
<b>Poultry</b>			<b>3 to 5 lbs.</b>	<b>Over 5 lbs.</b>	
Chicken or Duck	325°	Well Done:	35-40	30-35	185°-190°
Chicken pieces	350°	Well Done:	35-40		185°-190°
Turkey	325°	Well Done:	10 to 15 lbs. 18-25	Over 15 lbs. 15-20	In thigh: 185°-190°

\*For boneless rolled roasts over 6 inches thick, add 5 to 10 minutes per pound to times given above.

†The U. S. Department of Agriculture says "Rare beef is popular, but you should know that cooking it to only 140°F. means some food poisoning organisms may survive." (Source: Safe Fe&d 'Book. Your Kitchen Guide. USDA Rev. June 1985.)

# BROILING

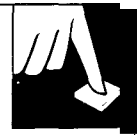

Broiling is cooking food by intense radiant heat from the upper broil unit in the oven. Most fish and tender cuts of meat can be broiled. Follow these directions to keep spattering and smoking to a minimum.

1. If the meat has fat or gristle around the edge, cut vertical slashes through both about 2 inches apart. If desired, the fat may be trimmed, leaving a layer about 1/8 inch thick.
2. Place the meat on the broiler grid in the broiler pan. Always use the grid so the fat drips into the broiler pan; otherwise the juices may become hot enough to catch on fire.
3. Position a flat shelf on the recommended shelf position as suggested in the Broiling Guide. Most broiling is done on C position, but if your oven is connected to 208 volts, you may wish to use a higher position.
4. **Leave the door open to broil stop position.** The door stays open by itself, yet the proper temperature is maintained in the oven.
5. Press the BROIL pad.



6. Press the INCREASE pad for HI Broil or press the DECREASE pad for LO Broil.

To change from HI Broil to LO Broil, press the DECREASE pad once.

**NOTE:** Use LO Broil to cook foods such as poultry or thick pork chops thoroughly without over browning them.

7. Turn the food only once during broiling. Time the foods for the first side according to the Broiling Guide.

Turn the food, then use the times given for the second side as a guide to the preferred doneness. (Where 2 thicknesses and times are given together, use the first times given for the thinnest food.)

8. When broiling is finished press the CLEAR/OFF pad. Serve the food immediately, and leave the pan outside the oven to cool during the meal for easiest cleaning.

## Use of Aluminum Foil

You can use aluminum foil to line your broiler pan and broiler grid. However, you must mold the foil tightly to the grid and cut slits in it just like the grid.

Without the slits, the foil will prevent fat and meat juices from draining to the broiler pan. The juices could become hot enough to catch on fire. If you do not cut the slits, you are frying, not broiling.

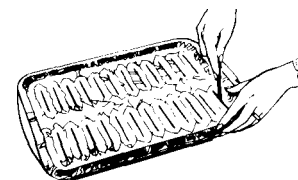

## Questions and Answers

**Q. When broiling, is it necessary to always use a grid in the pan?**

**A. Yes.** Using the grid suspends the meat over the pan. As the meat cooks, the juices fall into the pan, thus keeping meat drier. Juices are protected by the grid and stay cooler, thus preventing excessive spatter and smoking.

**Q. Should I salt the meat before broiling?**

**A. No.** Salt draws out the juices and allows them to evaporate. Always salt-after cooking. Turn meat with tongs; piercing meat with a fork also allows juices to escape. When broiling poultry or fish, brush each side often with butter.

**Q. Why are my meats not turning out as brown as they should?**

**A.** In some areas, the power (voltage) to the range may be low. In these cases, preheat the broil unit for 10 minutes before placing broiler pan with food in oven. Check to see if you are using the recommended shelf position. Broil for longest period of time indicated in the Broiling Guide. Turn food only once during broiling.

**Q. Do I need to grease my broiler grid to prevent meat from sticking?**

**A. No.** The broiler grid is designed to reflect broiler heat, thus keeping the surface cool enough to prevent meat from sticking to the surface. However, spraying the broiler grid lightly with a vegetable cooking spray before cooking will make clean-up easier.



# BROILING GUIDE

- Always use the broiler pan and grid that comes with your oven. It is designed to minimize smoking and spattering by trapping juices in the shielded lower part of the pan.
- The oven door should be open to the broil stop position.**
- For steaks and chops, slash fat evenly around the outside edges of the meat. To slash, cut crosswise through the outer fat surface just to the edge of the meat. Use tongs to turn meat over to prevent piercing the meat and losing juices.
- If desired, marinate meats or chicken before broiling, or brush with barbecue sauce last 5 to 10 minutes only.
- When arranging food on the pan, do not let fatty edges hang over the sides. These could soil the oven bottom.
- The broiler does not need to be preheated. However, for very thin foods, or to increase browning, preheat if desired.
- Frozen steaks can be broiled by positioning the oven shelf at next lowest shelf position and increasing cooking time given in this guide 1½ times per side.
- If your range is connected to 208 volts, rare steaks may be broiled by preheating the broiler and positioning the oven shelf one position higher.

Food	Quantity and/or Thickness	Shelf Position	First Side Time, Minutes	Second Side Time, Minutes	Comments
<b>Bacon</b>	1/2 lb. (about 8 thin slices)	C	4½	4½	Arrange in single layer
<b>Ground Beef</b>	1 lb. (4 patties)				Space evenly.
Well Done	1/2 to ¾ inch thick	C	10	7	Up to 8 patties <b>take about same time.</b>
<b>Beef Steaks</b>					
Rare	1 inch thick	C	6	5	Steaks less than 1 inch thick cook through before browning. Pan frying is recommended.
Medium	(1 to 1½ lbs.)	C	8	6	
Well Done		C	12	11	
Rare	1½ inch thick	C	10	7-8	Slash fat.
Medium	(2 to 2½ lbs.)	C	15	14-16	
Well Done		C	25	20-25	
<b>Chicken</b>	<b>1 whole (2 to 2½ lbs.), split lengthwise</b>	A	35	10-15	Reduce time about 5 to 10 minutes per side for cut-up chicken. Brush each side with melted butter. Broil skin-side-down first.
<b>Bakery Products</b>					
<b>Bread</b> (Toast) or Toaster Pastries	2 to 4 slices	C or D	1½-2	1/2	Space evenly. Place English muffins <b>cut-side-up</b> and brush with butter, if desired.
English Muffins	1 pkg. (2) 2 (split)	C or D	3-4		
<b>Lobster Tails</b>	<b>2-4 (6 to 8 oz. each)</b>	<b>B</b>	13-16	Do not turn over.	<b>Cut</b> through back of shell. Spread open. Brush with melted butter before broiling and after half of broiling time.
<b>Fish</b>	1-lb. fillets 1/4 to 1/2 inch thick	<b>C</b>	5	5	Handle and turn very carefully. Brush with lemon butter before and during cooking, if desired. Preheat broiler to increase browning.
<b>Ham Slices</b> (precooked)	1 inch thick	B	8	8	Increase time 5 to 10 minutes per side for 1½ inch thick or home cured ham.
<b>Pork Chops</b>	<b>2 (1/2 inch thick)</b>	<b>C</b>	10	10	Slash fat.
Well Done	2 (1 inch thick), about 1 lb.	B	13	13	
<b>Lamb Chops</b>					
Medium	2 (1 inch thick), about 10 to 12 oz.	C	10	9	Slash fat.
Well Done		C	12	10	
Medium	2 (1X inch thick), about 1 lb.	C	14	12	
Well Done		B	17	12-14	
<b>Wieners and similar</b> precooked sausages, bratwurst	<b>1-lb. pkg. (10)</b>	<b>C</b>	6	1-2	If desired, split sausages in half lengthwise; cut into 5- to 6-inch pieces.

# OPERATING THE SELF-CLEANING OVEN

Normal Cleaning Time: 3 hours

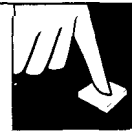

## Quick Reminder:

1. Prepare the oven for cleaning.
2. Close the oven door.
3. Press the CLEAN pad.
4. Press the INCREASE or DECREASE pad to set the Clean Time.

## Before a Clean Cycle

**The range must be completely cool in order to set the self-clean cycle.**

1. Remove the broiler pan, broiler rack, all cookware and any aluminum foil from the oven—they can't withstand the high cleaning temperatures.

**NOTE: The oven shelves may be cleaned in the self-cleaning oven.** However, they will darken, lose their luster and become hard to slide. Wipe the shelf supports with cooking oil after self-cleaning to make shelves slide more easily.

2. Wipe up heavy soil on the oven bottom. If you use soap, rinse thoroughly before self-cleaning to prevent staining.

**JTE:** Do not clean the bake unit or broil unit. Any soil will burn off when the units are heated. The bake unit can be lifted gently to clean the oven floor. If spillover, residue, or ash accumulate around the bake unit, gently wipe around the unit with warm water.

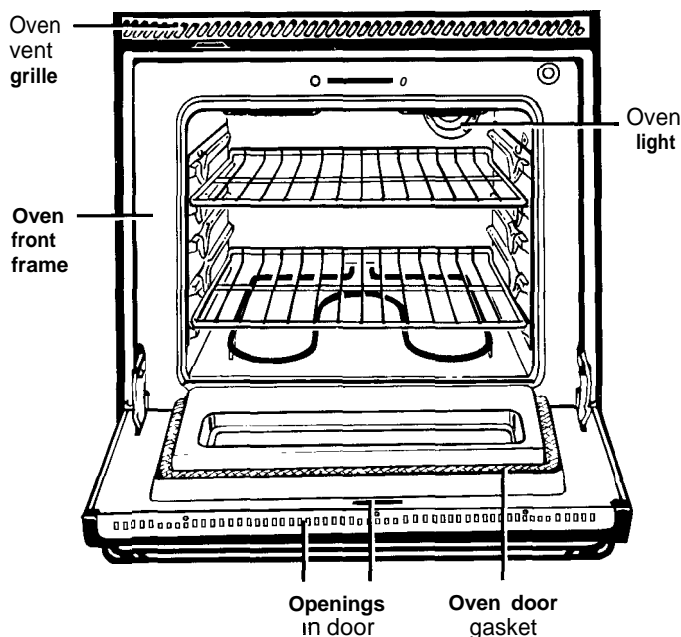

3. Clean spatters or soil on the oven front frame and the oven door outside the gasket with a dampened cloth. The oven front frame and the oven door outside the gasket do not get cleaned by the self-clean cycle. On these areas, use detergent and hot water or a soap-filled steel wool pad. Rinse well with a vinegar and water solution. This will help prevent a brown residue from forming when the oven is heated. Buff these areas with a dry cloth. Do not clean the gasket. Never use a commercial oven cleaner in or around the self-cleaning oven. Clean the outside front of the oven door with soap and water. Also use soap and water to clean under the oven vent grille. **Do not use abrasives or oven cleaners.**

Make sure the oven light bulb cover is in place.

**Do not rub or clean the door gasket—** the fiberglass material of the gasket has an extremely low resistance to abrasion. An intact and well-fitting oven door gasket is essential for energy-efficient oven operation and good baking results. If you notice the gasket becoming worn, frayed or damaged in any way or if it has become displaced on the door, you should have it replaced.

**Do not let water run down through openings in the top of the door.** To help prevent water from getting in these slots when cleaning, open the door as far as it will go.

4. Close the oven door and make sure the oven light is off. If the oven light is not turned off, the life of the bulb will be shortened or it may burn out immediately. The door latches automatically after the clean cycle is set.

**Do not use commercial oven cleaners or oven protectors in or near the self-cleaning oven.** A combination of any of these products plus the high clean-cycle temperature may damage the porcelain finish of the oven.

*(continued next page)*



# OPERATING THE SELF-CLEANING OVEN

(continued)

## How to Set Oven for Cleaning

### Quick Reminder:

1. Prepare the oven for cleaning.
2. Close the oven door completely.
3. Press the CLEAN pad.
4. Press the INCREASE or DECREASE pad until the desired Clean Time appears.

If the oven is too hot and you start to set a clean cycle, the word "OFF" will appear in the display. Allow additional time for cooling before you try to set the cycle.

1. Follow the directions to prepare the oven for cleaning.



CLEAN

2. Press the CLEAN pad.



3. Press the INCREASE or DECREASE pad until the desired Clean Time is displayed.

Clean Time is normally 3 hours. You can change the Clean Time to anywhere between 2 and 4 hours, depending on how dirty your oven is.

The self-clean cycle will automatically begin after "CLEAN" is displayed and the time for the clean cycle is set. The words "ON" and "LOCK" will appear in the display when the door automatically locks. It will not be possible to open the oven door until the temperature drops below the lock temperature and the LOCK light goes off.

4. When the LOCK light is off, open the door.



STOP  
TIME

NOTE: You can find out when the clean cycle will be finished by pressing the STOP TIME button.

The word "door" will be displayed, the word "LOCK" will flash and oven control will signal if you set the clean cycle and forget to close the oven door.

## To Stop a Clean Cycle



CLEAR  
OFF

1. Press the CLEAR/OFF pad.

2. Wait until the oven has cooled below locking temperature. You will not be able to open the door right away unless the oven temperature is at a safe level.



### After Self-Cleaning

You may notice some white ash in the oven. Just wipe it up with a damp cloth after the oven cools.

**If white spots remain**, remove them with a soap-filled steel wool pad. Be sure to rinse thoroughly with a vinegar and water mixture. These deposits are usually a salt residue that cannot be removed by the clean cycle.

If the oven is not clean after 1 clean cycle, repeat the cycle.

**NOTE:** No functions can be programmed before the door automatically unlocks.

### How to Set Delay Start of Cleaning

#### Quick Reminder:

1. Prepare the oven for cleaning.
2. Close the oven door completely.
3. Press the CLEAN pad.
4. Press the INCREASE or DECREASE pad until the desired Clean Time appears.
5. Press the STOP TIME pad.
6. Press the INCREASE or DECREASE pad until the desired Stop Time appears in the display.

Delay Start is setting the oven timer to start the clean cycle automatically at a later time than the present time of day.

**NOTE:** Before beginning, make sure the oven clock shows the correct time of day.

1. Follow steps to prepare the oven for cleaning.



2. Press the CLEAN pad.

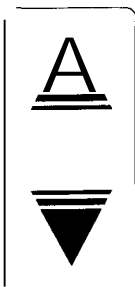

3. Press the INCREASE or DECREASE pad to enter the Clean Time.



4. Press the STOP TIME pad. "SET STOP TIME" and the earliest Stop Time you can set will appear in the display.

The earliest Stop Time will be the Clean Time selected plus the time of day. **For example:** If the Clean Time is 3 hours and the time of day is 6:00, the Stop Time that appears in the display will be 9:00.

5. Press the INCREASE pad to change the Stop Time to a later time of day if desired. **For example:** If you set the Stop Time at 11 :00, the oven will start the clean cycle at 8:00 and end at 11:00. The door latches automatically.

The self-clean cycle will automatically begin after "CLEAN" is displayed and the time for the clean cycle is set. The words "ON" and "LOCK" will appear in the display when the door automatically locks. It will not be possible to open the oven door until the temperature drops below the lock temperature and the LOCK light goes off.

6. When the LOCK light is off, open the door.

**NOTE:** During a delayed self-clean operation you can find out when the oven is set to turn on by pressing and holding the CLEAN pad for 3 seconds.

(continued next page)



# OPERATING THE SELF-CLEANING OVEN

(continued)

## Questions and Answers

- Q. If my oven clock is not set to the correct time of day, can I still self-clean my oven?**
- A.** If the clock is not set to the correct time of day you will not be able to set a delay clean to end at a specific time.
- Q. Can I use commercial oven cleaners on any part of my self-cleaning oven?**
- A.** No cleaners or coatings should be used around any part of this oven. If you do use them and do not thoroughly rinse the oven with water, wiping it absolutely clean afterwards, the residue can scar the oven surface and damage metal parts the next time the oven is automatically cleaned.
- Q. What should I do if excessive smoking occurs during cleaning?**
- A.** This is caused by excessive soil. Press the CLEAR/OFF pad. Open the windows to rid the room of smoke. Wait until the oven has cooled and the word "LOCK" is off in the display. Wipe up the excess soil and reset the clean cycle.
- Q. Is the "crackling" or "popping" sound I hear during cleaning normal?**
- A.** Yes. This is the sound of the metal heating and cooling during both the cooking and cleaning functions.
- Q. Should there be any odor during the cleaning?**
- A.** Yes, there will be an odor during the first few cleanings. Failure to wipe out excessive soil might also cause a strong odor when cleaning.
- Q. What causes the hair-like lines on the enameled surface of my oven?**
- A.** This is a normal condition, resulting from heating and cooling during cleaning. These lines do not affect how your oven performs.
- Q. Why do I have ash left in my oven after cleaning?**
- A.** Some types of soil will leave a deposit which is ash. It can be removed with a damp sponge or cloth.
- Q. My oven shelves do not slide easily. What is the matter?**
- A.** After many cleanings, oven shelves may become so clean they do not slide easily. To make shelves slide more easily, after each self-cleaning function dampen fingers with a small amount of cooking oil and rub lightly over sides of shelf where they contact shelf supports.
- Q. My oven shelves have become gray after the self-clean cycle. Is this normal?**
- A.** Yes. After the self-clean cycle, the shelves may lose some luster and change to a deep gray color.



# CARE AND CLEANING

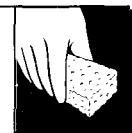

Proper care and cleaning are important so your oven will give you efficient and satisfactory service. Follow these directions carefully in caring for your oven to assure safe and proper maintenance.

## Removal of Packaging Tape

The safest way to remove the adhesive left from packaging tape on new appliances to assure no damage is done to the finish of the product is an application of a household liquid dishwashing detergent, mineral oil or cooking oil. Apply with a soft cloth and allow to soak. Wipe dry and then apply an appliance polish to thoroughly clean and protect the surface.

NOTE: The plastic tape that is not removed from the chrome trim on oven parts cannot be removed if baked on.

## Broiler Pan and Grid

After broiling, remove the broiler pan and grid from the oven. Remove the grid from the pan. Carefully pour out grease from the pan into a proper container. Wash and rinse the broiler pan and grid in hot water with a soap-filled or plastic scouring pad.

If food has burned on, sprinkle the grid with detergent while hot and cover with wet paper towels or a dishcloth. Soaking the pan will remove burned-on foods.

The broiler pan may be cleaned with a commercial oven cleaner. Do not use an oven cleaner on the grid.

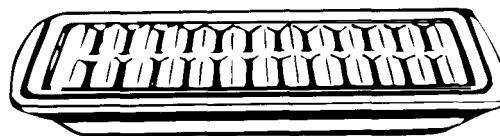

Do not store a soiled broiler pan and grid anywhere in the oven.

**Do not clean the broiler pan and grid in the self-cleaning oven.**

Both the broiler pan and grid can also be cleaned in the dishwasher.

## Oven Shelves and Convection Roasting Rack

Clean the oven shelves (including the offset shelf) and the convection roasting rack with an abrasive cleanser or steel wool. After cleaning, rinse the shelves and rack with clean water and dry with a clean cloth.

To remove heavy, burned-on soil, scouring pads may be used. After scrubbing, wash with soapy water, rinse well and dry.

NOTE: The oven shelves and convection roasting rack may be cleaned in the self-cleaning oven, however, the shelves may darken in color, lose their luster and become hard to slide if cleaned during the self-cleaning cycle.

Wipe the shelf supports with cooking oil after self-cleaning to make the shelves slide more easily.

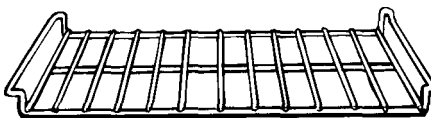
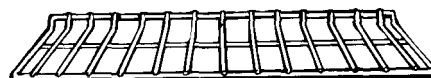

(continual next page)



# CARE AND CLEANING

(continued)

## Lift-Off Oven Door

The oven door is **removable**, but it is heavy. You may need help removing and replacing the door. Do not lift the door by the handle. This can cause the glass to break or can cause damage to the door.

To **remove the door**, open it a few inches to the special stop position that will hold the door open. Grasp firmly on each side and lift the door straight up and off the hinges.

NOTE:

- Be careful not to place hands between the hinge and the oven door frame as the hinge could snap back and pinch fingers.
- While working in the oven area, cover the hinges with towels or empty paper towel rolls to prevent pinched fingers and chipping the porcelain enamel on the frame.

To **replace the door**, make sure the hinges are in the special stop position. Position the slots in the bottom of the door squarely over the hinges. Then lower the door slowly and evenly over both hinges at the same time. If hinges snap back against the oven frame, pull them back out.

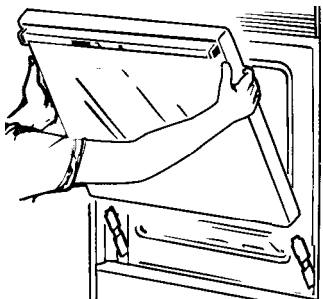

## TO CLEAN THE DOOR:

### Inside of the door:

- Because the area inside the gasket is cleaned during the self clean cycle, you do not need to clean this by hand. Any soap left on the liner causes additional stains when the oven is heated.
- The area outside the gasket can be cleaned with a scouring pad.
- Do not rub or clean the door gasket—the fiberglass material of the gasket has an extremely low resistance to abrasion. An intact and well-fitting oven door gasket is essential for energy-efficient oven operation and good baking results. If you notice the gasket becoming worn, frayed or damaged in any way or if it has become displaced on the door, you should have it replaced.

NOTE: The gasket is designed with a gap at the bottom to allow for proper air circulation.

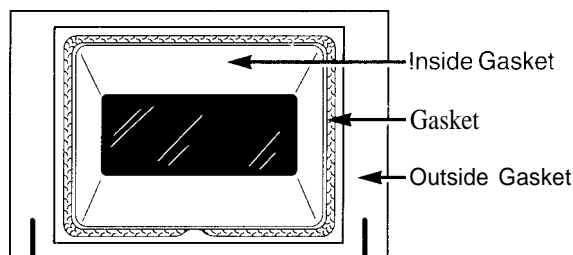

### Outside of the door:

- Use soap and water to thoroughly clean the top, sides and front of the oven door. Rinse well. You may also use a glass cleaner to clean the glass on the outside of the door.
- Spillage of marinades, fruit juices, tomato sauces and basting materials containing acids may cause discoloration and should be wiped up immediately. When surface is cool, clean and rinse.
- Do not use oven cleaners, cleansing powders or harsh abrasives on the outside of the door.

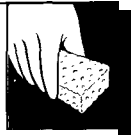

## Probe

The temperature probe may be cleaned with soap and water or a soap-filled scouring pad. Cool the temperature probe before cleaning. Scour stubborn spots with a soap-filled scouring pad, rinse and dry.

**Do not immerse the temperature probe in water. Do not store the temperature probe in the oven.**

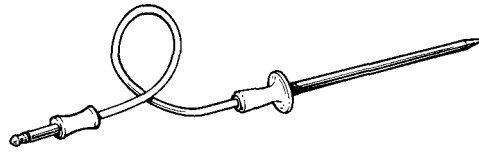

## Oven Light Replacement

**CAUTION:** Before replacing your oven light bulb, disconnect the electrical power for your oven at the main fuse or circuit breaker panel or pull the plug. Be sure to let the light cover and bulb cool completely before removing or replacing them. When in use, light bulbs can become warm enough to break if touched with a moist cloth or towel. When cleaning, avoid touching warm lights with cleaning cloths if the light cover is removed.

The oven light is covered with a glass removable cover which is held in place with a wire. Remove the oven door, if desired, to reach the cover easily.

### To remove:

Hold your hand under the cover so it doesn't fall when released. With fingers of the same hand, firmly push back the wire until it clears the cover. Lift off the cover.

### DO NOT REMOVE ANY SCREWS.

Replace bulb with 40-watt home appliance bulb.

### To replace cover:

Place it into the groove of the light receptacle. Pull the wire forward to the center of cover until it snaps in place. When in place, the wire holds the cover firmly. Be certain the wire is in the depression in the center of the cover.

Connect the electrical power to the oven.

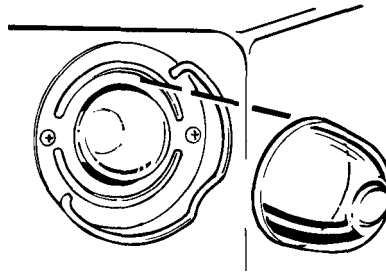

*(continued next page)*



## CARE AND CLEANING

(continued)

### Control Panel

**It's a good idea to wipe the control panel after each use.**

Clean with mild soap and water or vinegar and water, rinse with clean water and polish dry with a soft cloth.

**Do not use abrasive cleansers, strong liquid cleaners, plastic scouring pads or oven cleaners on the control panel—they will damage the finish.** A 50/50 solution of vinegar and hot water works well.

---

### Glass Surfaces

To clean the outside glass finish, use a glass cleaner. Rinse and polish with a dry cloth. **Do not allow the water or cleaner to run down inside openings in the top of the oven door while cleaning.**

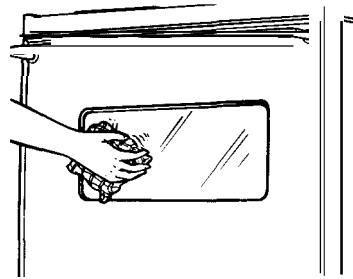

---

### Painted Surfaces

Painted surfaces include the outside oven door and control panel. Clean these with soap and water or a vinegar and water solution. **Do not use commercial oven cleaners, cleansing powders, steel wool or harsh abrasives on any painted surface.**

# QUESTIONS? USE THIS PROBLEM SOLVER



PROBLEM	POSSIBLE CAUSE
"F-" AND A NUMBER FLASH IN THE DISPLAY	<ul style="list-style-type: none"> <li>• This is the function error code. Press the CLEAR/OFF pad. Allow oven to cool 1 hour. Place oven back into operation. If function error occurs again, disconnect power to the oven and call for service.</li> </ul>
OVEN WILL NOT WORK	<ul style="list-style-type: none"> <li>• The circuit breaker in your house has been tripped, or a fuse has been blown.</li> <li>• Oven controls not properly set.</li> </ul>
OVEN LIGHT DOES NOT WORK	<ul style="list-style-type: none"> <li>* Light bulb is loose or defective. Tighten or replace.</li> <li>• Button operating oven light is broken. Call for service.</li> </ul>
FOOD DOES NOT BROIL PROPERLY	<ul style="list-style-type: none"> <li>• The oven controls are not properly set. See the Broiling section.</li> <li>• The door not left open to the broil stop position as recommended.</li> <li>• Improper shelf position being used.</li> <li>• Food is being cooked on a hot pan.</li> <li>• Cookware is not suited for broiling.</li> <li>• Aluminum foil used on the broiler pan grid has not been fitted properly and slit as recommended.</li> </ul>
FOOD DOES NOT ROAST OR BAKE PROPERLY	<ul style="list-style-type: none"> <li>• The oven controls are not properly set. See the Baking or Roasting section.</li> <li>• Shelf position is not correct.</li> <li>• Incorrect cookware of improper size is being used.</li> <li>• A foil tent was not used when needed to slow down browning during roasting.</li> <li>• The oven thermostat needs adjustment. See the Adjust the Oven Thermostat—<i>Do It Yourself</i> section.</li> </ul>
OVEN WILL NOT SELF-CLEAN	<ul style="list-style-type: none"> <li>• Temperature is too high to set self-clean operation. Allow the oven to cool, and reset the controls.</li> <li>• Probe is in oven. Remove the probe.</li> </ul>
OVEN DOOR WILL NOT OPEN	<ul style="list-style-type: none"> <li>• Oven must cool below locking temperature.</li> </ul>
OVEN NOT CLEAN AFTER CLEAN CYCLE	<ul style="list-style-type: none"> <li>• Oven controls not set properly. Review Operating the Self-Cleaning Oven section.</li> <li>• Heavily soiled ovens require 3 ½- to 4-hour Clean Time.</li> <li>• Heavy spillovers should be cleaned up before starting clean cycle.</li> </ul>
"door" APPEARS IN THE DISPLAY	<ul style="list-style-type: none"> <li>• Oven door not closed after self-clean cycle selected.</li> <li>• Door is still locked and you are trying to enter an oven cooking operation.</li> </ul>
"OFF" APPEARS IN THE DISPLAY	<ul style="list-style-type: none"> <li>• Oven is too hot for Self-Clean.</li> <li>• Bake or Broil attempted too soon after Self-Clean.</li> <li>• Child Lockout feature turned on.</li> </ul>

*(continued next page)*



## THE PROBLEM SOLVER

PROBLEM	POSSIBLE CAUSE
OVEN TEMPERATURE TOO HOT OR TOO COLD	<ul style="list-style-type: none"><li>• The oven thermostat needs adjustment. See the Adjust the Oven Thermostat—<i>Do It Yourself</i> section.</li></ul>
“BURNING” OR “OILY” ODOR EMITTING FROM OVEN WHEN TURNED ON	<ul style="list-style-type: none"><li>• This is normal in a new oven and will disappear in time. To speed the process, set a self-clean cycle for a minimum of 3 hours. See the Operating the Self-Cleaning Oven section.</li></ul>
STRONG ODOR	<ul style="list-style-type: none"><li>• An odor from the insulation around the inside of the oven is normal for the first few times the oven is used. This is temporary.</li></ul>

**If you need more help. ..call, toll free:**

**GE Answer Center™**

**800.626.2000**

**consumer information service**

# We'll Be There

With the purchase of your new GE appliance, receive the assurance that if you ever need information or assistance from GE, we'll be there. All you have to do is call—toll-free!

## **h-Home Repair Service** **800-GE-CARES (800-432-2737)**

A GE consumer service professional will provide expert repair service, scheduled at a time that's convenient for you. Many GE Consumer Service company-operated locations offer you service today or tomorrow, or at your convenience (7:00 a.m. to 7:00 p.m. weekdays, 9:00 a.m. to 2:00 p.m. Saturdays). Our factory-trained technicians know your appliance inside and out—so most repairs can be handled in just one visit.

## **GE Answer Center®** **800.626.2000**

Whatever your question about any GE major appliance, GE Answer Center® information service is available to help. Your call and your question will be answered promptly and courteously. And you can call any time. GE Answer Center® service is open 24 hours a day, 7 days a week.

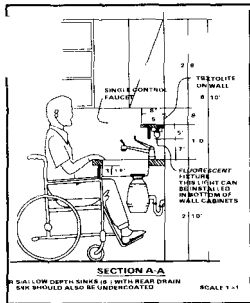

## **For Customers With Special Needs...** **800.626.2000**

Upon request, GE will provide Braille controls for a variety of GE appliances, and a brochure to assist in planning a barrier-free kitchen for persons with limited mobility. To obtain these items, free of charge, call 800.626.2000.

Consumers with impaired hearing or speech who have access to a TDD or a conventional teletypewriter may call 800-TDD-GEAC (800-833-4322) to request information or service.

## **Service Contracts** **800-626-2224**

You can have the secure feeling that GE Consumer Service will still be there after your warranty expires. Purchase a GE contract while your warranty is still in effect and you'll receive a substantial discount. With a multiple-year contract, you're assured of future service at today's prices.

## **Parts and Accessories** **80&626-2002**

Individuals qualified to service their own appliances can have needed parts or accessories sent directly to their home. The GE parts system provides access to over **47,000** parts... and all GE Genuine Renewal Parts are fully warranted. VISA, MasterCard and Discover cards are accepted.

User maintenance instructions contained in this booklet cover procedures intended to be performed by any user. **Other servicing generally should be referred to qualified service personnel. Caution must be exercised, since improper servicing may cause unsafe operation.**

# YOUR GE ELECTRIC OVEN WARRANTY

**Staple sales slip or cancelled check here. Proof of original purchase date is needed to obtain service under warranty.**

## WHAT IS COVERED

### FULL ONE-YEAR WARRANTY

For one year from date of original purchase, we will provide, free of charge, parts and service labor in your home to repair or replace **any part of the oven** that fails because of a manufacturing defect.

This warranty is extended to the original purchaser and any succeeding owner for products purchased for ordinary home use in the 48 mainland states, Hawaii and Washington, D.C. In Alaska the warranty is the same except that it is LIMITED because you must pay to ship the product to the service shop or for the service technician's travel costs to your home.

All warranty service will be provided by our Factory Service Centers or by our authorized Customer Care® servicers during normal working hours.

Should your appliance need service, during warranty period or beyond, call 800-GE-CARES (800-432-2737).

## WHAT IS NOT COVERED

- Service trips to your home to teach you how to use the product.

### Read your Use and Care material.

If you then have any questions about operating the product, please contact your dealer or our Consumer Affairs office at the address below, or call, toll free:

GE Answer Center™  
800.626.2000  
consumer information service

- Improper installation.

If you have an installation problem, contact your dealer or installer. You are responsible for providing adequate electrical, gas, exhausting and other connecting facilities as described in the Installation Instructions provided with the product.

- Replacement of house fuses or resetting of circuit breakers.
- Failure of the product if it is used for other than its intended purpose or used commercially.
- Damage to product caused by accident, fire, floods or acts of God.

**WARRANTOR IS NOT RESPONSIBLE FOR CONSEQUENTIAL DAMAGES.**

Some states do not allow the exclusion or limitation of incidental or consequential damages, so the above limitation or exclusion may not apply to you. This warranty gives you specific legal rights, and you may also have other rights which vary from state to state. To know what your legal rights are in your state, consult your local or state consumer affairs office or your state's Attorney General.

**Warrantor: General Electric Company**

**If further help is needed concerning this warranty, write:  
Manager—Consumer Affairs, GE Appliances, Louisville, KY 40225**



Recycled Paper

Part No. 16#D2588P258

Pub No. 49-8458

MNU099 Rev. 3

7-93 CG

JKP16

JKPI 7

JKP18

Printed in LaFayette, GA