

HW-C700  
HW-C700B  
HW-C770S  
HW-C770BS

# AV Receiver System user manual

imagine the possibilities

Thank you for purchasing this Samsung product.  
To receive more complete service,  
please register your product at  
[www.samsung.com/register](http://www.samsung.com/register)



# Safety information

## SAFETY WARNINGS

TO REDUCE THE RISK OF ELECTRIC SHOCK, DO NOT REMOVE THE COVER(OR BACK). NO USER-SERVICEABLE PARTS ARE INSIDE. REFER SERVICING TO QUALIFIED SERVICE PERSONNEL.



This symbol indicates “dangerous voltage” inside the product that presents a risk of electric shock or personal injury.



This symbol indicates important instructions accompanying the product.

### Note to CATV system installer

This reminder is provided to call the CATV system installer’s attention to Section 820~40 of the NEC which provides guidelines for proper grounding and, in particular, specifies that the cable ground shall be connected to the grounding system of the building, as close to the point of cable entry as practical.

### WARNING

To reduce the risk of fire or electric shock, do not expose this appliance to rain or moisture.

### CAUTION

Apparatus shall not be exposed to dripping or splashing and no objects filled with liquids, such as vases, shall be placed on the apparatus.

## PRECAUTIONS

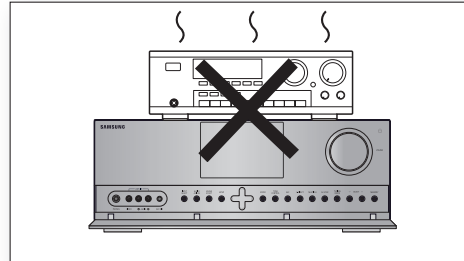
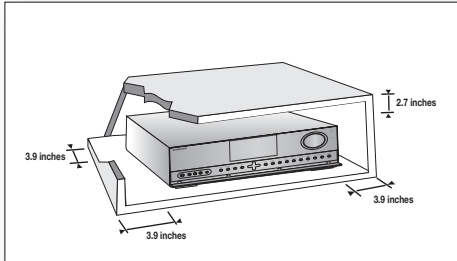

Ensure that the AC power supply in your house complies with the identification sticker located on the back of your player. Install your player horizontally, on a suitable base (furniture), with enough space around it for ventilation (3-4inches). Make sure the ventilation slots are not covered. Do not stack anything on top of the amplifier. In order to disconnect the player completely from the power supply, remove the AC plug from the wall outlet, especially when left unused for a long period of time.

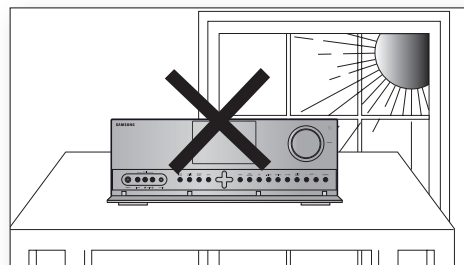
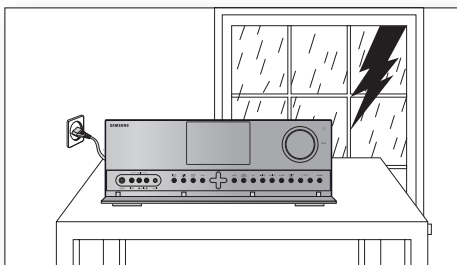

During thunderstorms, disconnect the AC plug from the wall outlet. Voltage peaks due to lightning could damage the unit.

Do not expose the unit to direct sunlight or other heat sources. This could lead to overheating and malfunction of the unit.

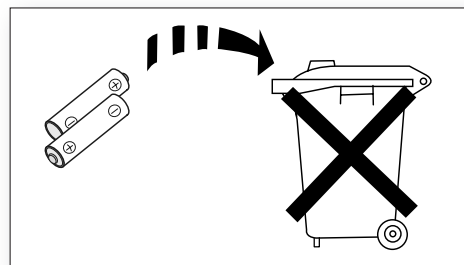
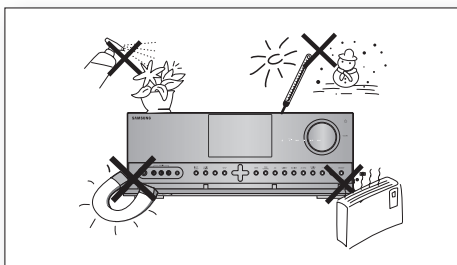

Protect the player from moisture (i.e. vases), and excess heat (e.g. fireplace) or equipment creating strong magnetic or electric fields (i.e. speakers...). Disconnect the power cable from the AC supply if the player malfunctions. Your player is not intended for industrial use. Use of this product is for personal use only. Condensation may occur if your player or disc have been stored in cold temperatures. If transporting the player during the winter, wait approximately 2 hours until the unit has reached room temperature before using.

The batteries used with this product contain chemicals that are harmful to the environment. Do not dispose of batteries in the general household trash.

# Features

## Digital AV Receiver

This product is a pure digital AV receiver that performs digital signal processing to minimize signal distortion and loss.

## Dolby Pro Logic IIx

Dolby Pro Logic IIx is a new technology that provides discrete 7.1 channels out of 2 channel or multi channel sources. It also provides Music, Movie and Game modes. Dolby Pro Logic IIx is an improved surround system that is optimized to a 7.1 CH multimedia system, enabling you to maximize your entertainment experience.

## Dolby Pro Logic IIz

Dolby Pro Logic IIz adds front height channels to surround sound, creating a 7.1 playback system for video games, home music, and movies; bringing enhanced spatial effects and enveloping sound.

## DTS 96/24

DTS 96/24 encodes standard 16 bit/44.1 kHz sound to 24 bit/96kHz and applies it to a 5.1 CH sound track.

## DOLBY DIGITAL EX

Adds a surround back channel for more spacious sound compared to regular 5.1 channel Dolby Digital.

## DTS (Digital Theater Systems)

DTS provides a discrete 5.1 CH digital audio signal for both music and movie contents and uses less compression than Dolby Digital for richer sound.

## Dolby Digital Plus

Dolby Digital Plus is the next-generation audio technology for all high-definition programming and media.

## Dolby True-HD

Dolby True-HD is Dolby's next-generation lossless technology developed for high-definition disc-based media.

## DTS-HD (Master Audio, High Resolution) (Digital Theater Systems - High Definition)

DTS-HD Audio provides the highest quality multi-channel sound possible. It delivers sound quality that matches the clear and vivid images of high-definition video.

## DTS NEO:6

Provides a full range of 6 channels by converting a digital PCM or analog stereo signal using DTS digital matrix decoding.

## iPod



You can enjoy music files by connecting your iPod/iPhone to the AV Receiver with the supplied iPod dock.

## SFE (Sound Field Effect) Using 32bit Audio Digital Signal Processing

Provides more realistic surround sound with normal stereo audio sources.

## Anynet+ (HDMI-CEC) Function

Anynet+ is a function that can be used to operate this AV Receiver with a Samsung TV remote control, by connecting the receiver to a SAMSUNG TV using an HDMI Cable. (This function is available only in connection with Samsung TV and DVD player supporting Anynet+(HDMI-CEC).)

## DTS-ES (Extended Surround)

The DTS-ES (Extended Surround) system is a new multi digital signal format that was developed by Digital Theater Systems Inc.

Supporting full compatibility with the conventional DTS digital surround sound format, the DTS-ES (Extended Surround) system improves the surround signal for a 360-degree surround effect.

DTS-ES adds an additional rear center surround channel for 6.1 channel sound.

## ACCESSORIES

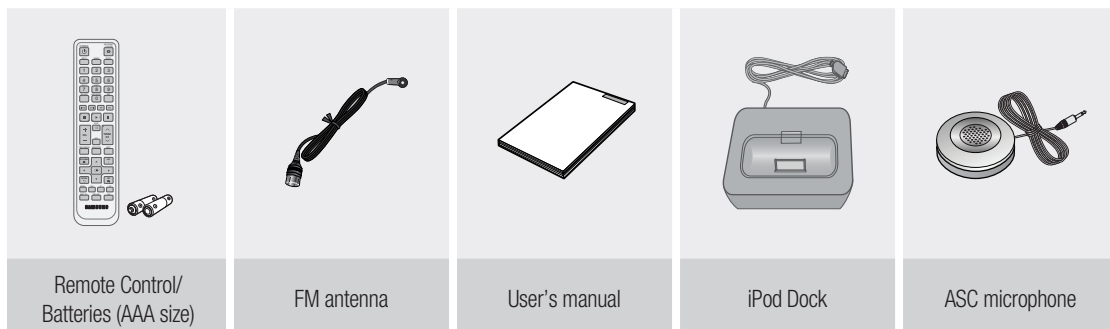

# Contents

ENG

## **SAFETY INFORMATION**

2

- 2 Safety Warnings
- 3 Precautions

## **FEATURES**

4

- 4 Accessories

## **DESCRIPTION**

7

- 7 Front Panel
- 8 Rear Panel
- 10 Display
- 11 Insert Remote Control Batteries
- 11 Operation Range of the Remote Control
- 12 Tour of the Remote Control

## **CONNECTIONS**

14

- 14 Speaker Positioning
- 16 Connecting the Speakers
- 17 Connecting External Devices/Your TV via HDMI
- 18 HDMI Function
- 19 Connecting to your TV
- 20 Connecting a DVD or BD(Blu-ray) Player
- 21 Connecting a Cable, Satellite or Set-top Box
- 22 Connecting a VCR
- 23 Connecting a CD Player
- 24 Connecting 7.1 Channel Devices
- 25 Connecting an iPod
- 27 Connecting the FM Antenna
- 27 Connecting Aux Components

## **BASIC FUNCTIONS OF YOUR AV RECEIVER**

28

- 28 Before Using the AV Receiver
- 28 Audio Setup
- 29 Selecting Digital/Analog Input

● CONTENTS

# Contents

---

## **SETUP** 30

- 30 Setup Menu Tree
- 34 Setting the Speaker Size
- 35 Setting the Speaker Listening Distance
- 36 Setting the Speaker Level
- 37 Setting the Test Tone
- 38 Setting Dolby Pro Logic Mode
- 38 Setting Dolby Pro Logic IIx
- 39 Setting Dolby Pro Logic IIz
- 39 Setting Tone Control
- 40 Setting NEO:6 Mode
- 41 Setting EX/ES Mode
- 42 AV SYNC
- 42 MP3 Enhancer
- 42 Smart Volume
- 43 ASC (Auto Sound Calibration) Setup
- 44 DRC Setup
- 44 HDMI Setup
- 44 Variable Set

## **OPERATION** 45

- 45 Using the Surround Modes
- 46 Using the Subwoofer Selection Button
- 47 Listening to the Radio
- 48 Using an iPod
- 50 Convenient Functions
- 51 Software Upgrade

## **MISCELLANEOUS** 52

- 52 Operating Your TV With the Remote Control
- 54 Operating your DVD or BD player with the remote control

## **TROUBLESHOOTING** 55

- 55 Troubleshooting

## **APPENDIX** 57

- 57 Specifications

# Description

## FRONT PANEL

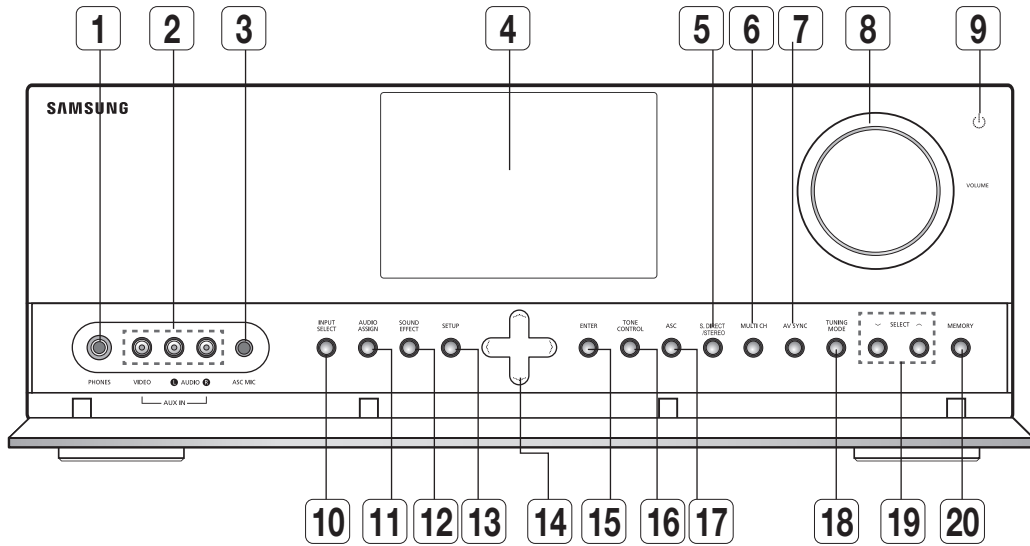

<b>1</b>	<b>HEADPHONE JACK</b>	Used to connect a set of headphones.
<b>2</b>	<b>AUX IN JACKS</b>	Auxiliary AV input terminals used to connect a camcorder, portable DVD player or gaming device.
<b>3</b>	<b>ASC MIC JACK</b>	Used to connect the ASC MIC for setting up ASC (Auto Sound Calibration).
<b>4</b>	<b>DISPLAY</b>	Displays the speaker/audio input status, listening mode, etc.
<b>5</b>	<b>S.DIRECT/STEREO BUTTON</b>	Used to select the S.DIRECT or STEREO mode.
<b>6</b>	<b>MULTI CH BUTTON</b>	Used to select a connected 7.1 multi channel player.
<b>7</b>	<b>AV SYNC BUTTON</b>	Used to select the Audio Delay Mode.
<b>8</b>	<b>VOLUME CONTROL</b>	Adjusts the volume level.
<b>9</b>	<b>POWER</b>	Turns the receiver on/off.
<b>10</b>	<b>INPUT SELECT BUTTON</b>	Used to select a source. (FM → BD/DVD → SAT → TV → VCR → CD → AUX → 7.1 MULTI CH → IPOD AUDIO → IPOD VIDEO).
<b>11</b>	<b>AUDIO ASSIGN BUTTON</b>	Toggles to select an input mode for the selected source.
<b>12</b>	<b>SOUND EFFECT BUTTON</b>	Toggles to select a surround sound mode.
<b>13</b>	<b>SETUP BUTTON</b>	Displays the SETUP menu.
<b>14</b>	<b>UP(▲), DOWN(▼), LEFT(◀), RIGHT(▶) BUTTONS</b>	Used to move the cursor up, down, left or right. Also used to select detailed options in the SOUND EFFECT mode and to change the tone level.
<b>15</b>	<b>ENTER BUTTON</b>	Used to select an item in the SETUP menu.
<b>16</b>	<b>TONE CONTROL BUTTON</b>	Used to set the bass, treble level and tone to on/off.
<b>17</b>	<b>ASC BUTTON</b>	Used to select the ASC (Auto Sound Calibration) mode.
<b>18</b>	<b>TUNING MODE BUTTON</b>	Used to select the Manual or Preset mode for FM radio.
<b>19</b>	<b>SELECT BUTTON</b>	Used to change the radio frequency.
<b>20</b>	<b>MEMORY BUTTON</b>	Used to set a preset radio frequency.

# Description

## REAR PANEL

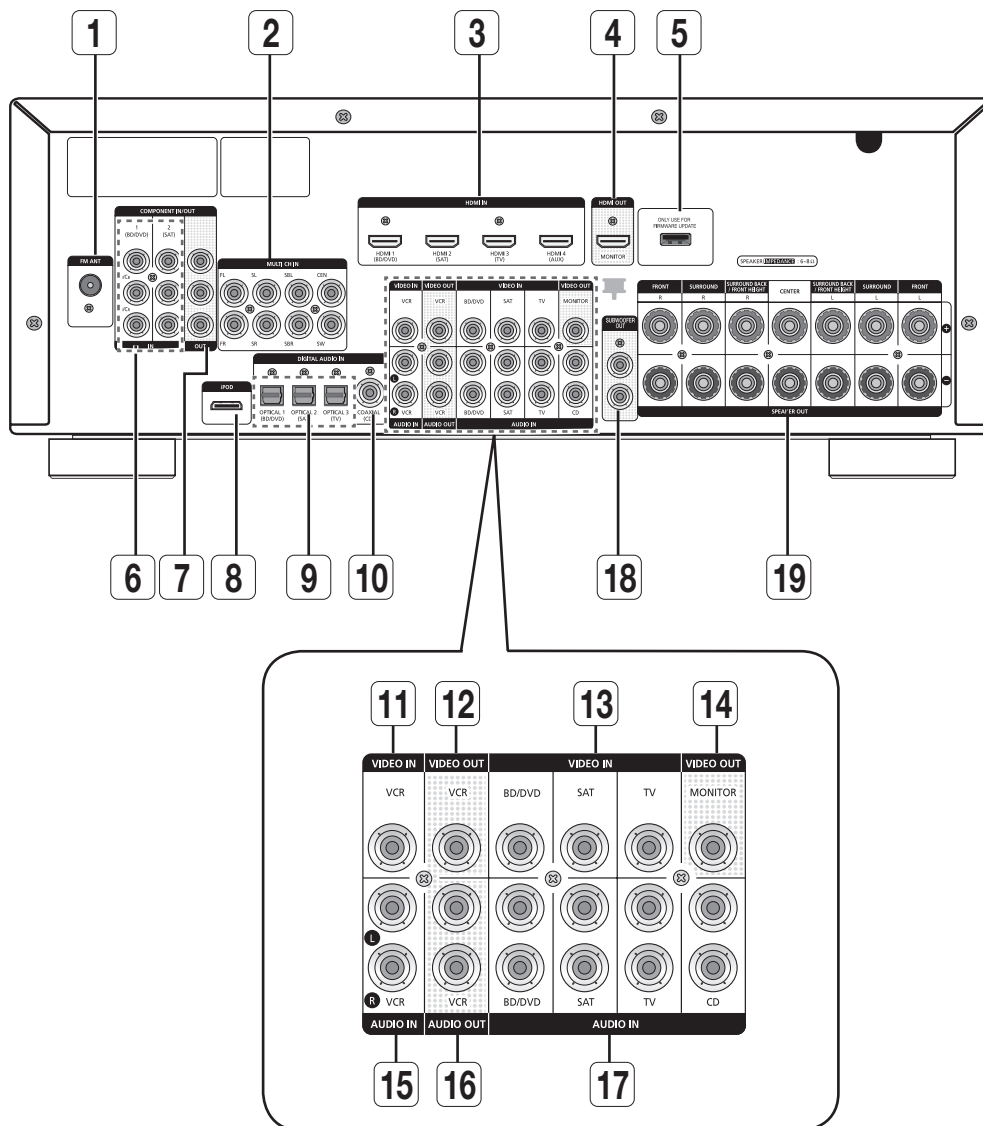



<b>1</b>	<b>FM ANTENNA JACK</b>	Connect the FM Antenna here.
<b>2</b>	<b>MULTI CH IN JACKS</b>	Receives the analog audio signal from an external player with a multi-channel port.
<b>3</b>	<b>HDMI IN JACKS</b>	Receives digital video and audio signals simultaneously using an HDMI cable.
<b>4</b>	<b>HDMI OUT JACK</b>	Outputs digital video and audio signals simultaneously using an HDMI cable.
<b>5</b>	<b>USB PORT</b>	Can be only used for firmware upgrades.
<b>6</b>	<b>COMPONENT VIDEO IN JACKS</b>	Receives the component video signal.
<b>7</b>	<b>COMPONENT VIDEO OUT JACKS</b>	Outputs the component video signal.
<b>8</b>	<b>iPod JACK</b>	Receives the audio/video signal from an iPod.
<b>9</b>	<b>OPTICAL IN JACKS (DIGITAL AUDIO IN)</b>	Receives the digital optical audio signal.
<b>10</b>	<b>COAXIAL IN JACK (DIGITAL AUDIO IN)</b>	Receives the digital coaxial audio signal.
<b>11</b>	<b>VCR VIDEO IN JACK</b>	Receives the video signal from a VCR.
<b>12</b>	<b>VCR VIDEO OUT JACK</b>	Outputs the video signal to a VCR.
<b>13</b>	<b>VIDEO IN JACKS</b>	Receives the video signal from a video player (BD/DVD, SAT,TV).
<b>14</b>	<b>VIDEO OUT JACK</b>	Outputs the video signal to video devices (TV, Projector etc).
<b>15</b>	<b>VCR AUDIO IN JACKS</b>	Receives the audio signal from a VCR.
<b>16</b>	<b>VCR AUDIO OUT JACKS</b>	Outputs the audio signal to a VCR.
<b>17</b>	<b>AUDIO IN JACKS</b>	Receives the audio signal from a video player (BD/DVD, SAT,TV, CD).
<b>18</b>	<b>SUBWOOFER AUDIO OUT JACKS</b>	Connect the subwoofers.
<b>19</b>	<b>SPEAKER OUT TERMINALS</b>	Speaker connection terminals.

# Description

## DISPLAY

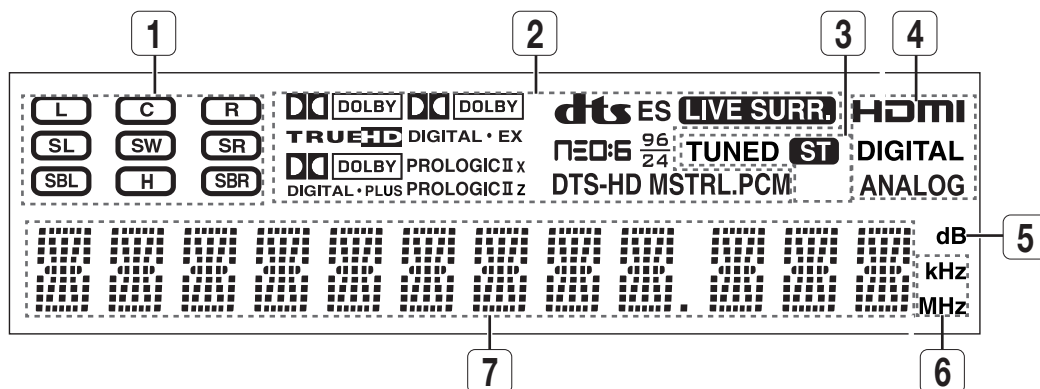

<b>1</b>	<b>SPEAKER INDICATORS</b>	Displays the connected speakers.
<b>2</b>	<b>LISTENING MODE INDICATORS</b>	Displays the current listening mode.
<b>3</b>	<b>TUNING INDICATORS</b>	Displays the status of the current radio broadcast.
<b>4</b>	<b>AUDIO INPUT INDICATORS</b>	Displays the audio input signal type of the currently connected external audio source.
<b>5</b>	<b>SPEAKER LEVEL INDICATOR</b>	Displays the speaker level.
<b>6</b>	<b>RADIO FREQUENCY INDICATORS</b>	Displays the current radio frequency range.
<b>7</b>	<b>MESSAGE DISPLAY</b>	Informs you of the status of the receiver.

## INSERT REMOTE CONTROL BATTERIES

\* Battery size: AAA

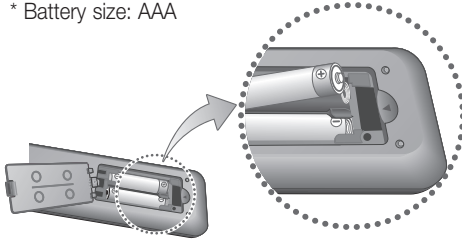

Follow these precautions to avoid leaking or cracking cells:

- Place batteries in the remote control so they match the polarity : (+) to (+) and (-) to (-).
- Assuming typical TV usage, the batteries last for about one year.
- Use the correct type of batteries. Batteries that look similar may differ in voltage.
- Always replace both batteries at the same time.
- Do not expose the batteries to heat or a flame.

## OPERATION RANGE OF THE REMOTE CONTROL

The remote control can be used up to approximately 23 feet/7 meters in a straight line. It can also be operated at a horizontal angle of up to 30° from the remote control sensor.

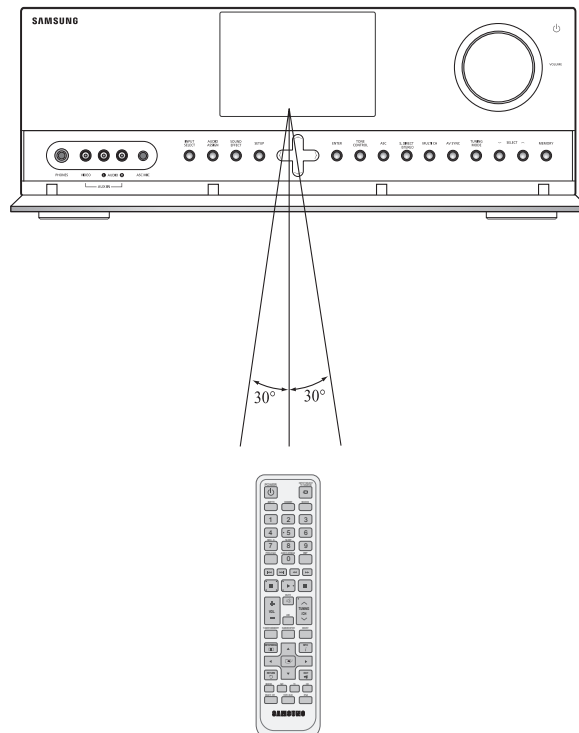

# Description

## TOUR OF THE REMOTE CONTROL

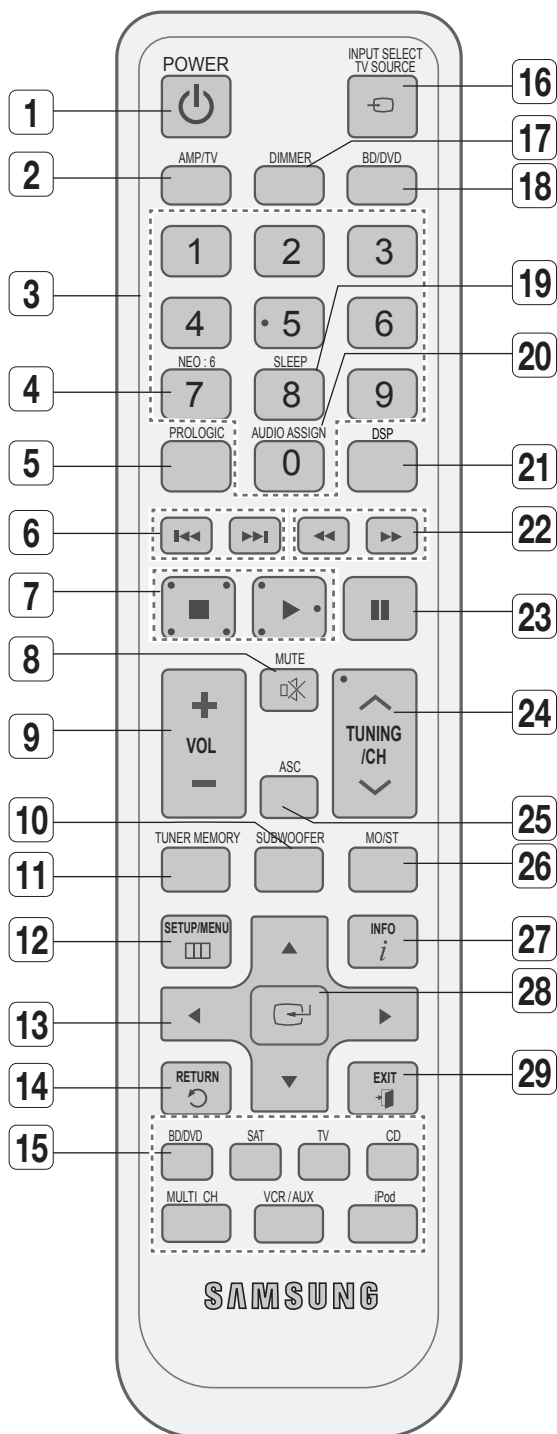

<b>1</b>	<b>POWER BUTTON</b>	Turns the receiver on/off.
<b>2</b>	<b>AMP/TV BUTTON</b>	Used to select the AMP/TV mode. - If you select the AMP mode, the button will flash orange. - If you select the TV mode, the button will flash green.
<b>3</b>	<b>NUMBER BUTTONS</b>	Used to select a TV channel.
<b>4</b>	<b>NEO : 6 BUTTON</b>	Select the desired NEO:6 mode.
<b>5</b>	<b>PROLOGIC BUTTON</b>	Select the desired Dolby Pro Logic audio mode.
<b>6</b>	<b>SKIP BUTTONS</b>	Press to skip backwards or forwards on a connected DVD/BD player or iPod.
<b>7</b>	<b>STOP/PLAY BUTTON</b>	Press to stop/start playback on a connected DVD/BD player or iPod.
<b>8</b>	<b>MUTE BUTTON</b>	Mutes the sound of a connected device.
<b>9</b>	<b>VOLUME CONTROL BUTTONS</b>	Adjusts the volume of the selected device.
<b>10</b>	<b>SUBWOOFER BUTTON</b>	Used to select the Subwoofer.
<b>11</b>	<b>TUNER MEMORY BUTTON</b>	Used to set a preset radio frequency.
<b>12</b>	<b>SETUP/MENU BUTTON</b>	Displays the SETUP menu.
<b>13</b>	<b>UP/DOWN/LEFT/RIGHT BUTTONS</b>	Used to navigate the menus.
<b>14</b>	<b>RETURN BUTTON</b>	Used to return to the previous menu from the SETUP menu.
<b>15</b>	<b>FUNCTION SELECTOR BUTTONS</b>	Used to select an input source.
<b>16</b>	<b>INPUT SELECT, TV SOURCE BUTTON</b>	Toggles to find and select an input source. Press to select a connected TV's video source.
<b>17</b>	<b>DIMMER BUTTON</b>	Adjusts the brightness of the display.
<b>18</b>	<b>BD/DVD BUTTON</b>	Used to select the BD/DVD mode. - If you select the BD mode, the button will flash orange. - If you select the DVD mode, the button will flash green.
<b>19</b>	<b>SLEEP BUTTON</b>	Used to set the Sleep Timer.
<b>20</b>	<b>AUDIO ASSIGN BUTTON</b>	Toggles to select an input mode for the selected source.
<b>21</b>	<b>DSP BUTTON</b>	Used to select the SFE mode.
<b>22</b>	<b>SEARCH BUTTON</b>	Press to search backwards or forwards.
<b>23</b>	<b>PAUSE BUTTON</b>	Pauses playback on a connected device.
<b>24</b>	<b>TUNING/CHANNEL BUTTONS</b>	Used to change the radio broadcasting frequency or TV channel.
<b>25</b>	<b>ASC BUTTON</b>	Used to set the Auto Sound Calibration function.
<b>26</b>	<b>MO/ST BUTTON</b>	Select MONO or STEREO for radio broadcasts.
<b>27</b>	<b>INFO BUTTON</b>	Display information on the connected device currently being used.
<b>28</b>	<b>ENTER BUTTON</b>	Used to select an item in the SETUP menu.
<b>29</b>	<b>EXIT BUTTON</b>	Exits the SETUP menu.

# Connections

This section involves various methods of connecting the AV receiver to other external components. Before moving or installing the product, be sure to turn off the power and disconnect the power cord.

## SPEAKER POSITIONING

There are two methods for positioning the speakers.

When using Dolby Pro Logic IIz, place the Surround Back Speakers in the FHL, FHR position and connect them to SURROUND BACK/ FRONT HEIGHT Jack.

\* The HW-C700/C700B model does not supply speakers (sold separately).

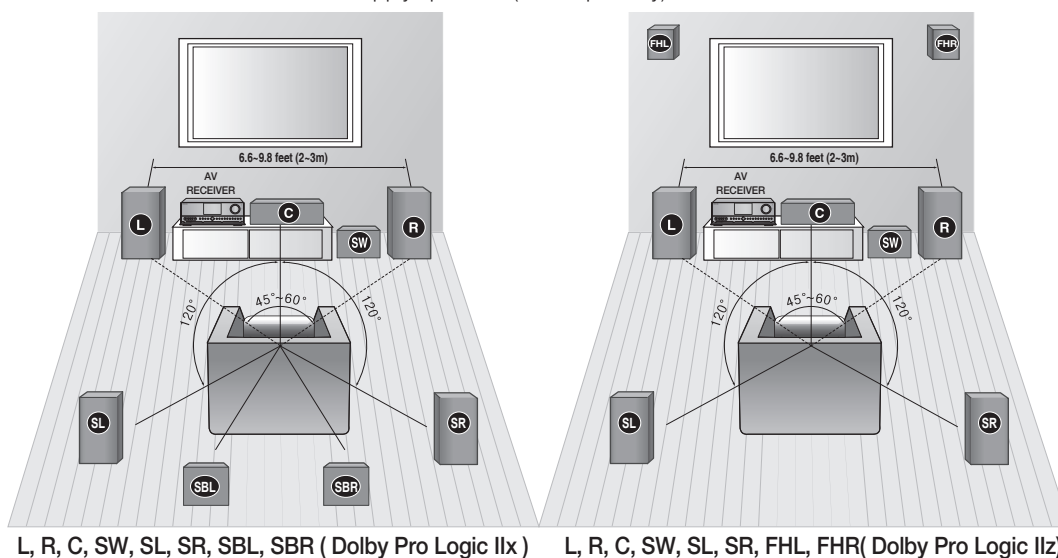

## Position of AV Receiver

Place the AV Receiver on a dedicated stand or rack.

## Subwoofer **SW**

The position of the subwoofer is not so critical. Place it anywhere you like.

### Subwoofer function (HW-C770S/C770BS only)

Active subwoofer with integrated 150W amplifier provides rich bass sound.

- Connect the **SW OUT** terminal of the amplifier to the **INPUT** terminal of the subwoofer speaker.
- Press the **POWER** button on the rear side of the subwoofer to turn the power on.
- Using the subwoofer's **VOLUME** control, you can set the desired bass level (See page 36 "Setting the speaker level" to set the subwoofer level in the menu).

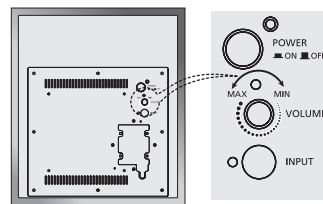

## Front Speakers **L R**

Place these speakers in front of your listening position, facing inwards (about 45°) toward you.

Place the speakers so that their tweeters will be at the same height as your ears.

Align the front face of the front speakers with the front face of the center speaker or place them slightly in front of the center speaker.

## Center speaker **C**

It is best to install it at the same height as the front speakers.  
You can also install it directly over or under the TV.

## Surround Speakers **SL SR**

Place these speakers behind your listening position.  
If there isn't enough room, place these speakers so they face each other.  
Place them about 2 to 3 feet (60 to 90cm) above your ears, facing slightly downward.  
Unlike the front and center speakers, the surround speakers are used to handle mainly sound effects and sound will not come from them all the time.

## Surround Back Speakers **SBL SBR**

If you are using two rear center speakers, place them behind the listening position.  
Place the surround back speaker about 2.3-3.3 feet (70 cm to 1 m).

## Front Height Speakers **FHL FHR** (Using Dolby Pro Logic IIz)

When using Dolby Pro Logic IIz, place the Surround Back Speakers on the FHL, FHR position above the front L and front R speakers at least 3.3 feet(1 m) above each one.

- Using the Surround Back Speakers as Front Height Speakers -

1. Fasten 2 screws(not supplied) for each speaker on the wall above the front L and R speakers.
2. Install the Surround Back Speakers (L, R) by fitting the holes on the back the Surround Back Speakers to the screws on the wall.

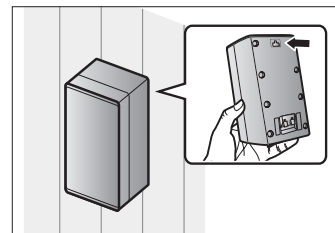

- When you attach the speakers to the wall, make sure to fasten them tightly so they do not fall off.

## Speaker Configuration

For the best surround-sound experience, you should connect seven speakers and a powered subwoofer.  
The following table shows which channels you should use based on the number of speakers you have.

2 speakers	3 speakers	4 speakers	5 speakers	6 speakers	7 speakers (DPL IIx)	7 speakers (DPL IIz)
<b>L</b>	<b>L</b>	<b>L</b>	<b>L</b>	<b>L</b>	<b>L</b>	<b>L</b>
<b>R</b>	<b>R</b>	<b>R</b>	<b>R</b>	<b>R</b>	<b>R</b>	<b>R</b>
	<b>C</b>		<b>C</b>	<b>C</b>	<b>C</b>	<b>C</b>
		<b>SL</b>	<b>SL</b>	<b>SL</b>	<b>SL</b>	<b>SL</b>
		<b>SR</b>	<b>SR</b>	<b>SR</b>	<b>SR</b>	<b>SR</b>
				<b>SBL</b>	<b>SBL</b>	<b>FHL</b>
					<b>SBR</b>	<b>FHR</b>

- No matter how many speakers you use, a powered subwoofer is recommended for powerful and solid bass.
- If you place a speaker near your TV set, screen colour may be distorted because of the magnetic field generated by the speaker. If this occurs, place the speaker away from your TV set.

# Connections

## CONNECTING THE SPEAKERS

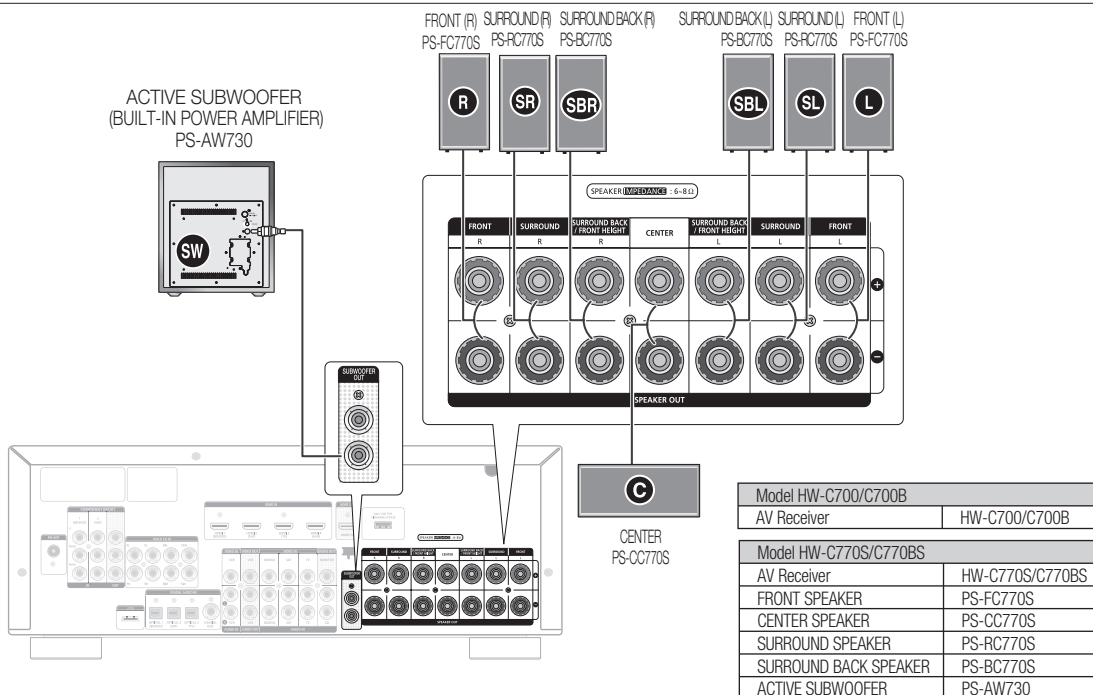

- One Active Subwoofer is provided, if you would like to use another, purchase it from the retailer where you bought the player and connect it to the other SUBWOOFER OUT Jack.
- When using Dolby Pro Logic IIz, connect the Surround Back Speakers (FHL, FHR) to SURROUND BACK/FRONT HEIGHT Jack.

### Connecting Speaker Wire

- Loosen the knob by turning counterclockwise.
- Insert the bare part of the wire into the hole in the side of each terminal.
- Tighten the knob by turning clockwise to secure the wire.

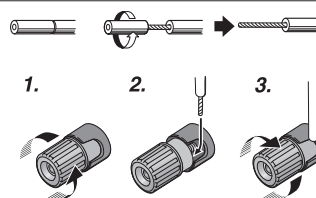

- Keep the subwoofer speaker out of reach of children to prevent them from inserting their hands or objects into the duct (hole).
- Never touch speaker terminals while the power is on. Doing so could result in electric shock.
- Make sure the polarities (+ and -) are correct.

### Connecting the Speakers

- Press down the terminal tab on the back of the speaker.
- Insert the black wire into the black terminal (-) and the red wire into the red (+) terminal, and then release the tab.
- Connect the connecting plugs to the back of the AV Receiver.
  - Make sure the colors of the speaker terminals on the back of the AV receiver match the colors of the connecting plugs.

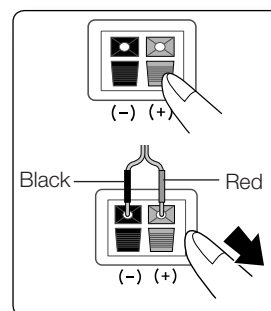



## CONNECTING EXTERNAL DEVICES/YOUR TV VIA HDMI

HDMI is a digital standard interface for connection to such devices as a TV, projector, DVD player, Blu-ray player, set-top box and more.

HDMI removes any loss of signal from analog conversion, enabling you to enjoy video and audio sound quality as it was originally created in the digital source.

By connecting through the HDMI(High-Definition Multimedia Interface) interface, you can play back digital video and audio.

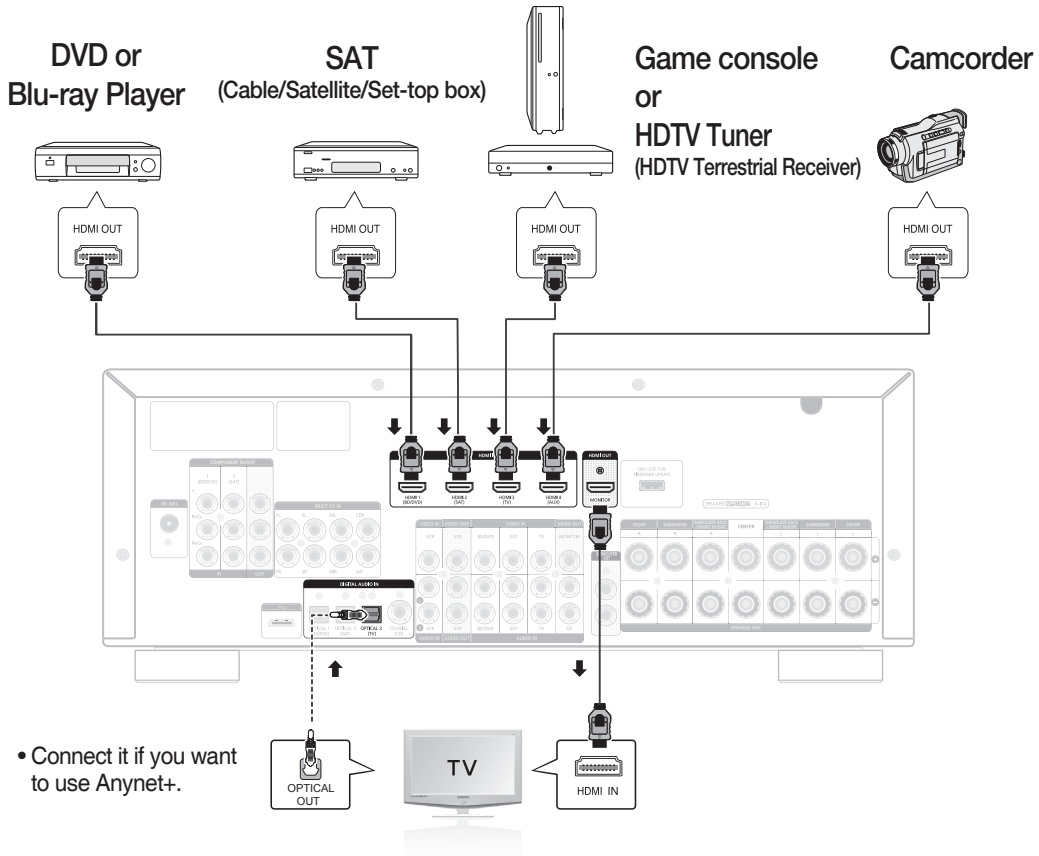

### High-bandwidth Digital Content Protection System (HDCP) support

To play digital contents through the HDMI connection, both the connected external device and TV must support High-bandwidth Digital Content Protection System (HDCP). This product supports HDCP.

Compatibility with a TV Supporting HDMI	
A TV with an HDMI jack.	Video/Audio
A TV with a DVI-D jack (TV supporting HDCP)	Video
A TV with a DVI-D jack (TV not supporting HDCP)	-

- Audio from SACD discs will not be heard with this connection. To play a DVD disc whose copyright is protected by CPPM, use a player supporting CPPM.
- The quality of the audio output through the HDMI jack (sampling frequency and bit rate) may be limited by the performance of the connected device.
- Since HDMI connection supports both video and audio, you don't have to connect an additional audio cable.

# Connections

---

## HDMI FUNCTION

---

### Using Anynet+(HDMI-CEC)

---

Anynet+ is a function that enables you to control other Samsung Devices with your Samsung TV's remote control. Anynet + can be used by connecting this AV Receiver to a SAMSUNG TV using an HDMI Cable. This is only available with SAMSUNG TVs and SAMSUNG AV Products that support Anynet+.

1. Connect the AV receiver to a Samsung TV with an HDMI cable. (See page 17)
2. Set the Anynet+ function on your TV.  
(See the TV instructions manual for more information.)
  - You can operate the volume on the AV receiver by using Volume buttons on the TV remote control.

### To turn on Anynet+

---

1. Press the **SETUP/MENU** button.
  - Each time the button is pressed, the mode switches between **SETUP ENTER** and **SETUP OFF**.
2. Press the **ENTER** button to select **SETUP ENTER**.
3. Press the **▲ ▼** buttons to select **HDMI SETUP**, and then press the **ENTER** or **▶** button.
4. Press the **▲ ▼** buttons to select **HDMI ANYNET+**, and then press the **ENTER** or **▶** button.
5. Press the **▲ ▼** buttons to set **ANYNET+** to **ON**.

#### - To exit setup mode-

- Press the **SETUP/MENU** button.  
**SETUP OFF** appears on the display and Setup Mode is exited.



- If you use an HDMI cable to connect a Samsung TV to your AV Receiver, you can operate the AV receiver using the TV's remote control. This function is available only in connection with Samsung TV and DVD player supporting Anynet +(HDMI-CEC).
- Please check your TV for the *Anynet+* logo. If your TV has an *Anynet+* logo, then it supports the Anynet+ function.
- When you are making Anynet+ connection, do not connect more than two AV receivers (Anynet+ installed). Otherwise, it can cause a malfunction.

## CONNECTING TO YOUR TV

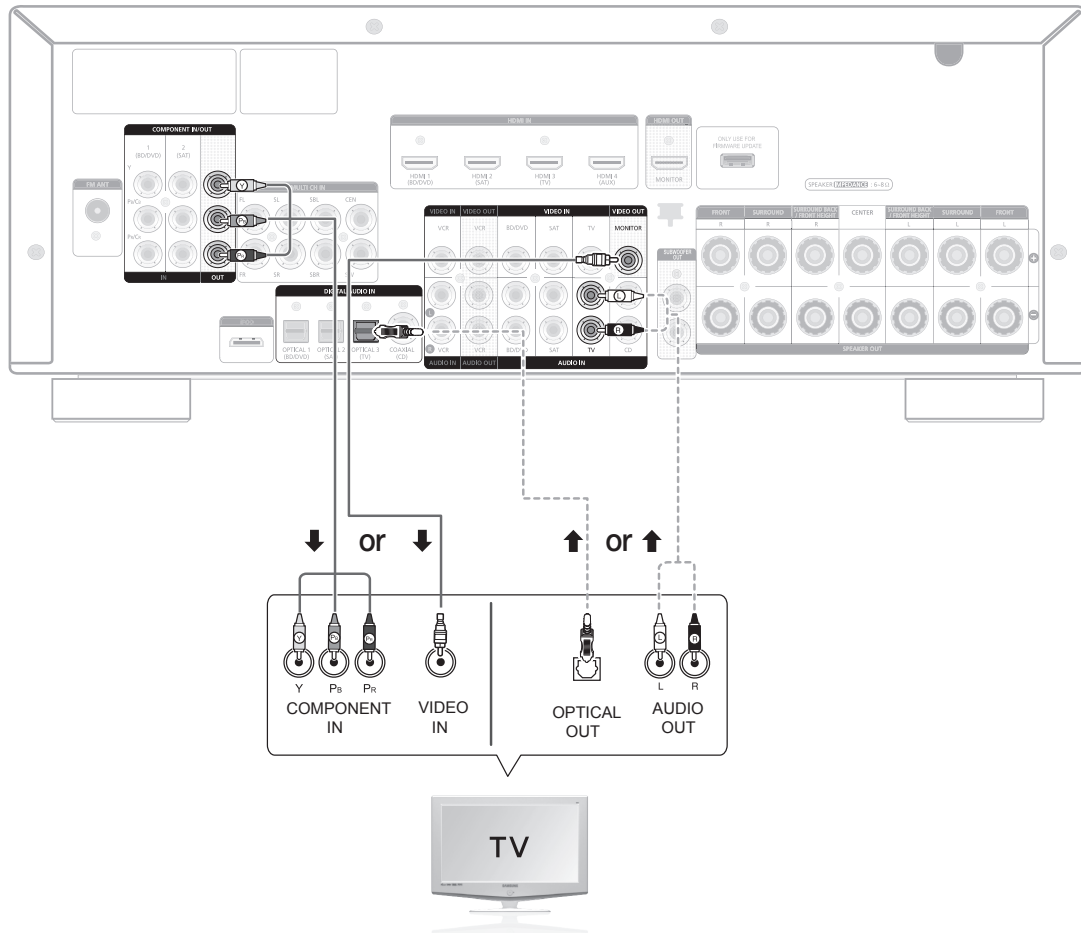

### Video Connection

If your television is equipped with Component Video inputs, connect a Component video cable(not supplied) from the Component Video Output (P<sub>R</sub>, P<sub>B</sub> and Y) jacks on the back of your AV Receiver to the Component Video Input jacks on your TV.

**OR**

Connect the Video cable from the VIDEO OUT (MONITOR) jack on the back of your AV Receiver to the Video Input jack on your TV.

### Audio Connection

Connect the Digital Input (OPTICAL 3) on your AV Receiver to the Digital Output of the TV.

**OR**

Connect AUDIO IN (TV) on your AV Receiver to the Audio Out of the TV.

# Connections

## CONNECTING A DVD OR BD(Blu-ray) PLAYER

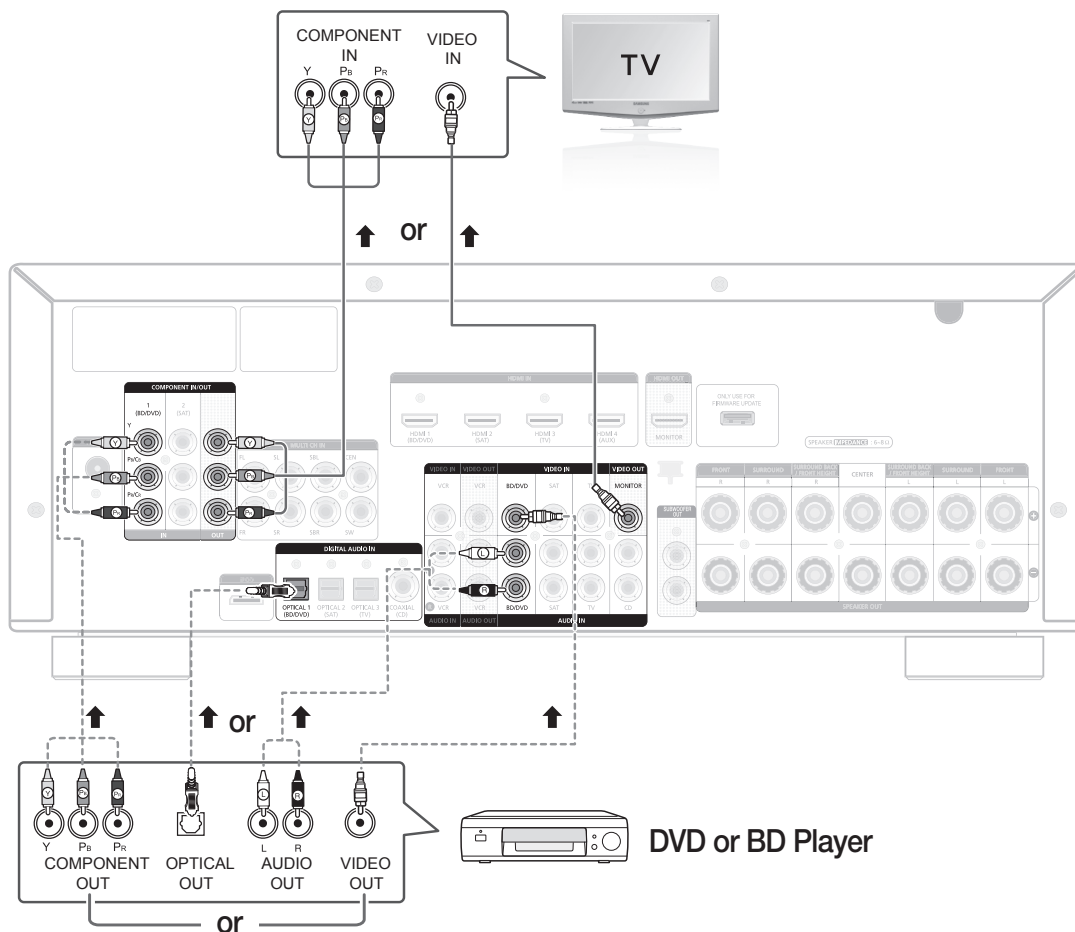

### Video Connection

Connect a Component video cable(not supplied) from the COMPONENT IN (BD/DVD) (P<sub>R</sub>, P<sub>B</sub> and Y) jacks on the back of your AV Receiver to the Component Video Output jacks on your DVD/BD player.

**OR**

Connect a Video cable from the VIDEO IN (BD/DVD) jack on the back of your AV Receiver to the Video Output jack on your DVD/BD player.

### Audio Connection

Connect the Digital Input (OPTICAL 1) on your AV Receiver to the Digital Output of the DVD/BD player.

**OR**

Connect AUDIO IN (BD/DVD) on your AV Receiver to the Audio Out of the DVD/BD player.

## CONNECTING A CABLE, SATELLITE OR SET-TOP BOX

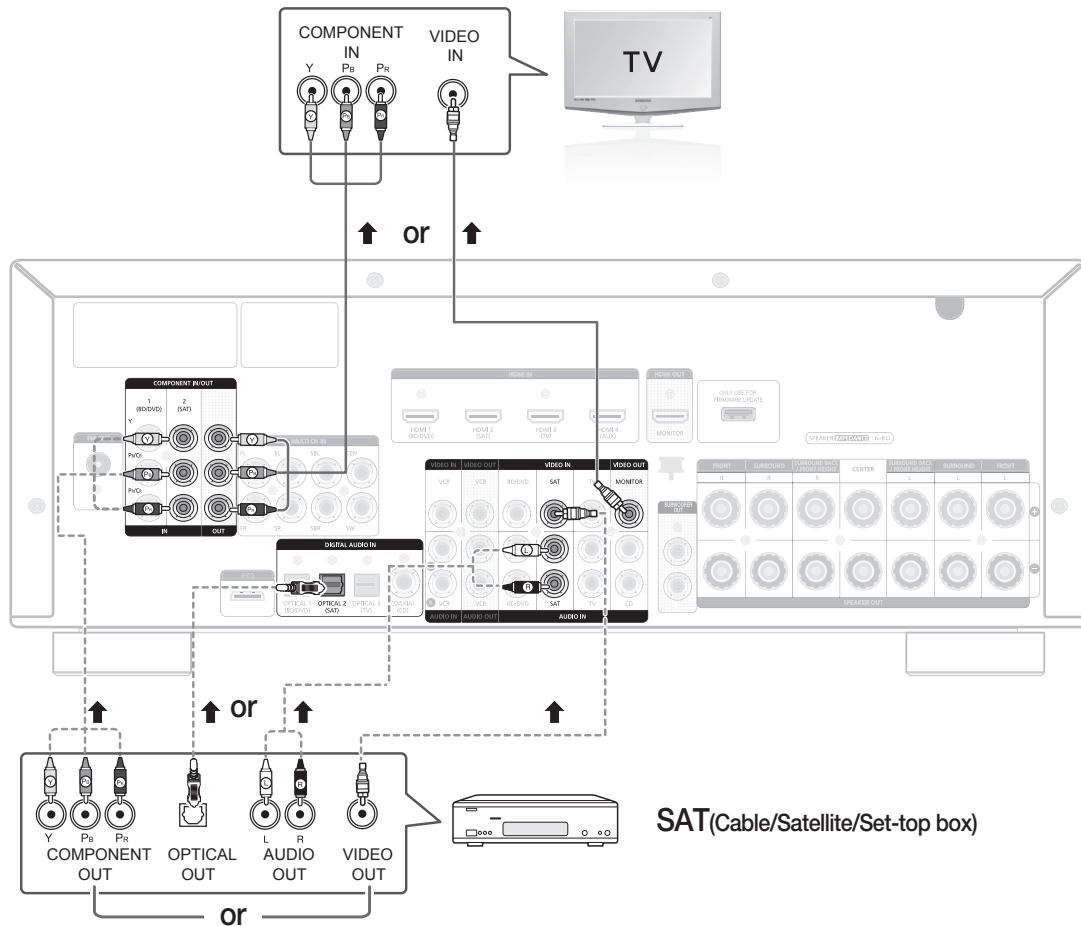

### Video Connection

Connect a Component video cable(not supplied) from the COMPONENT IN (SAT) (P<sub>R</sub>, P<sub>B</sub> and Y) jacks on the back of your AV Receiver to the Component Video Output jacks on your SAT.

**OR**

Connect a Video cable from the VIDEO IN (SAT) jack on the back of your AV Receiver to the Video Output jack on your SAT.

### Audio Connection

Connect the Digital Input (OPTICAL 2) on your AV Receiver to the Digital Output of the SAT.

**OR**

Connect AUDIO IN (SAT) on your AV Receiver to the Audio Out of the SAT.



- Disconnect the power plug from the outlet if you will not use this unit for a long period of time.
- If the cable/set-top box has only one audio output jack, connect it to either the right or left audio jack of the main unit. Connect the audio cable's red plug to the red jack and white cable to the white jack.

# Connections

## CONNECTING A VCR

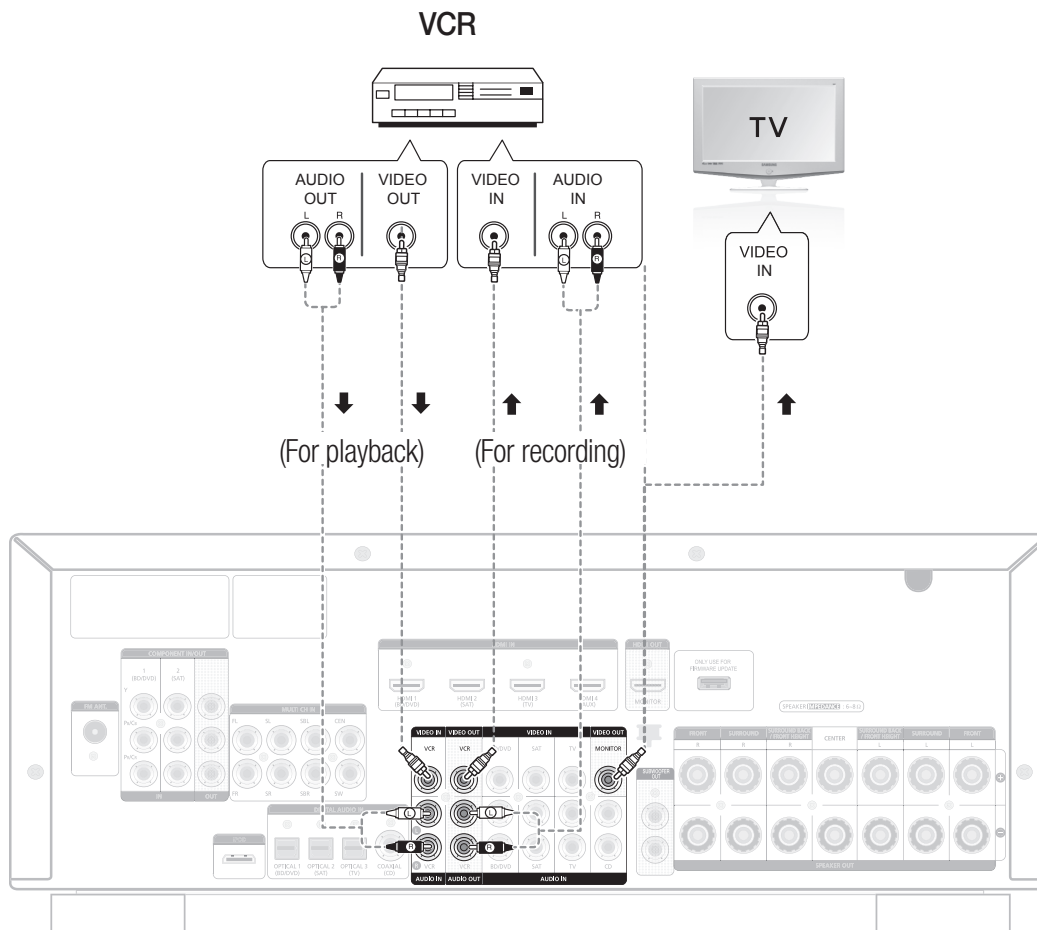

### Video Connection

#### For playback

Connect a Video cable from the VIDEO IN (VCR) jack on the back of your AV Receiver to the Video Output jack on your VCR.

#### For recording

Connect a Video cable from the VIDEO OUT (VCR) jack on the back of your AV Receiver to the Video Input jack on your VCR.

### Audio Connection

#### For playback

Connect AUDIO IN (VCR) on your AV Receiver to the Audio Out of the VCR.

#### For recording

Connect AUDIO OUT (VCR) on your AV Receiver to the Audio In of the VCR.



- Disconnect the power plug from the outlet if you will not use this unit for a long period of time.

## CONNECTING A CD PLAYER

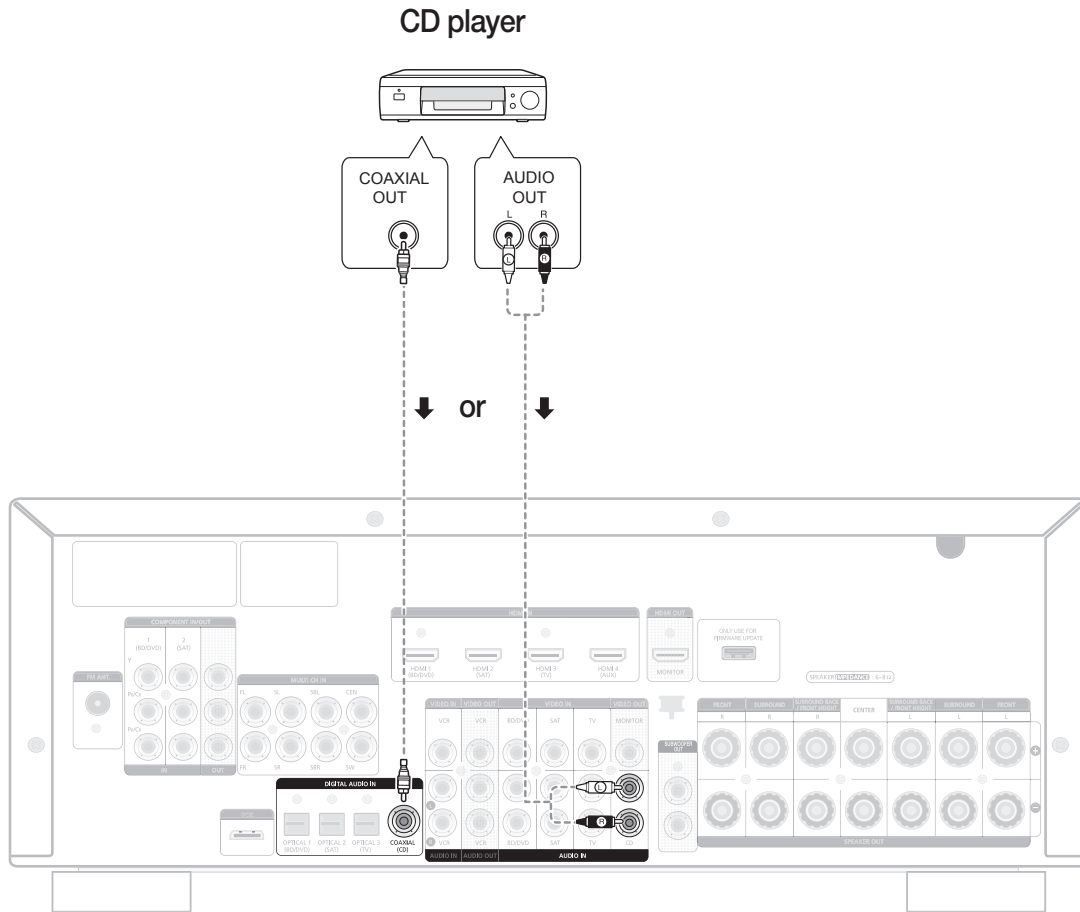

### Audio Connection

Connect the Digital Input (COAXIAL) on your AV Receiver to the Digital Output of the CD Player.

**OR**

Connect AUDIO IN (CD) on your AV Receiver to the Audio Out of the CD player.



- If the CD player has only one audio output jack, connect it to either the right or left audio input jack of the main unit. Connect the audio cable's red plug to the red jack and white cable to the white jack.

# Connections

## CONNECTING 7.1 CHANNEL DEVICES

You can connect the AV receiver to a DVD player, SUPER AUDIO CD player or other device with 7.1 channel output.

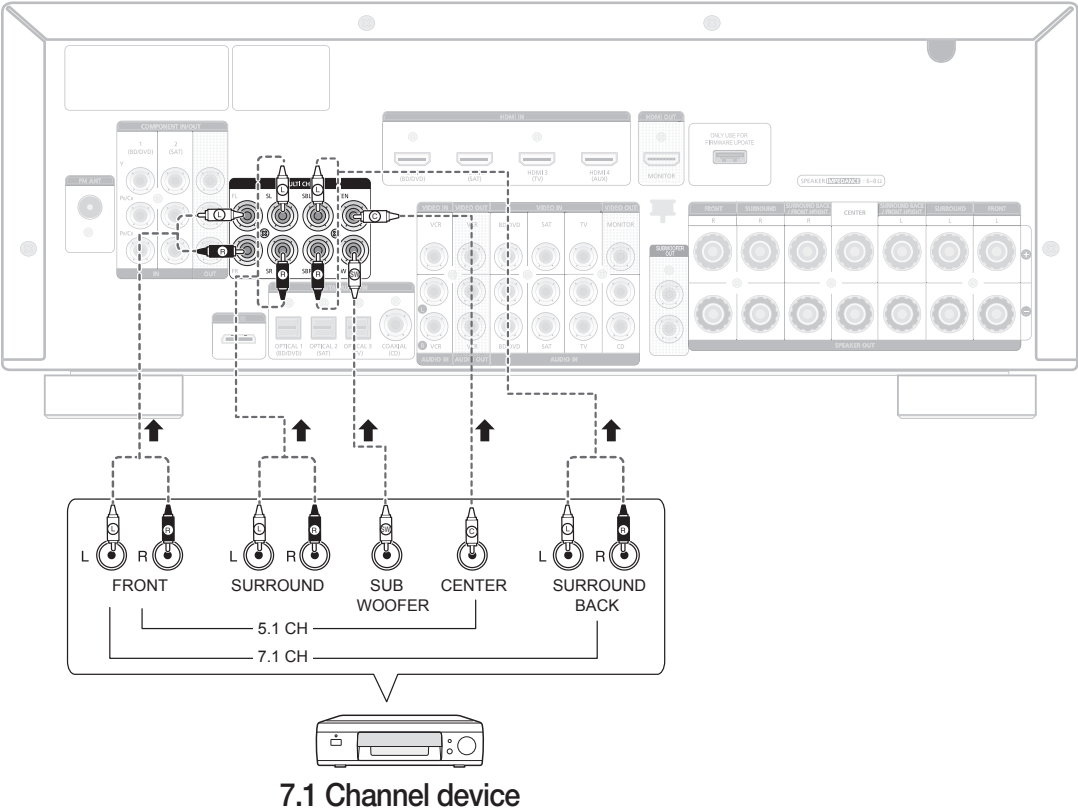



## CONNECTING AN iPod

You can listen to audio from an iPod through the main unit. For iPod operation with your receiver, see this page and 48 ~ 49.

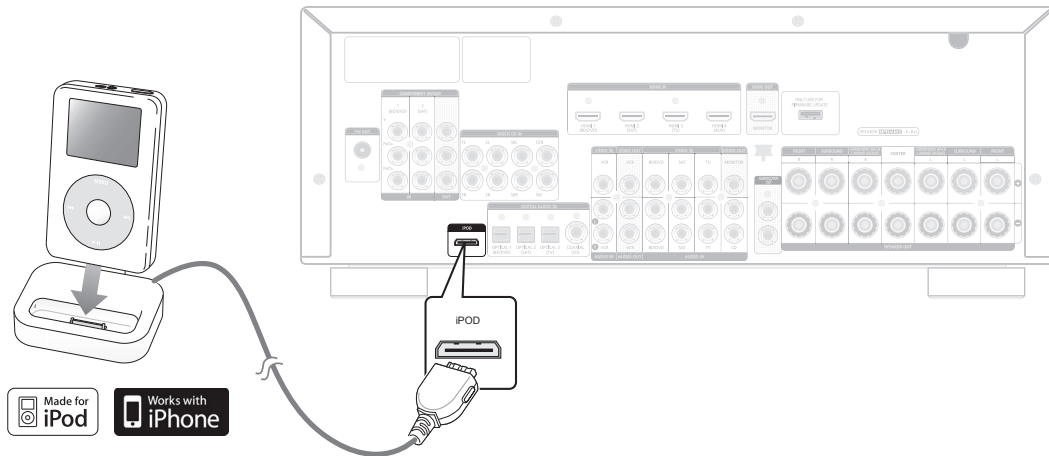

1. Connect the iPod dock connector to the iPod jack on your receiver.
2. Place the iPod in the Dock.
  - If you want to play a movie stored in your iPod player, you should set the player's **TV Out** option to **On** before inserting it into the dock. See page 49.
3. Press the **iPod** button on the remote control.
  - You can also use the **INPUT SELECT** button on the main unit.  
The mode switches as follows :  
**FM → BD/DVD → SAT → TV → VCR → CD → AUX → 7.1 MULTI CH → IPOD AUDIO → IPOD VIDEO**

## Disconnecting an iPod

Follow the steps below to prevent damage to an iPod and data when disconnecting from your AV receiver.

1. Press the **INPUT SELECT** button on the main unit to switch to a mode other than **IPOD AUDIO** or **IPOD VIDEO**.

OR

1. Turn off the AV Receiver.
2. Disconnect the iPod player from the iPod dock, or remove the iPod dock connector from the AV receiver.

















- You must have the VIDEO (Monitor or VCR) output connected to your TV to view iPod video. See page 22.
- Adjust the volume to a moderate level before you connect your iPod and AV Receiver.
- When the unit is powered on and you connect an iPod, the unit will charge your iPod's battery.
- Make sure to connect the dock connector so that the label "**SAMSUNG**" faces upward.
- "Made for iPod" means that an electronic accessory has been designed to connect specifically to an iPod and has been certified by the developer to meet Apple performance standards.
- "Works with iPhone" means that an electronic accessory has been designed to connect specifically to an iPhone and has been certified by the developer to meet Apple performance standards.

# Connections

## CONNECTING AN iPod (Continued)

### iPod models that are compatible with HW-C700/C700B/C770S/C770BS

 <p><b>iPod 1st+2nd generation</b> 5GB 10GB 20GB</p>	 <p><b>iPod 5th generation (video)</b> 30GB 60GB 80GB</p>	 <p><b>iPod 3rd generation</b> 10GB 15GB 20GB 30GB 40GB</p>
 <p><b>iPod nano 2nd generation (aluminum)</b> 2GB 4GB 8GB</p>	 <p><b>iPod mini</b> 4GB 6GB</p>	 <p><b>iPod 4th generation</b> 20GB 40GB</p>
 <p><b>iPod nano 3rd generation (video)</b> 4GB 8GB</p>	 <p><b>iPod 4th generation (color display)</b> 20GB 30GB 40GB 60GB</p>	 <p><b>iPod classic</b> 80GB 120GB 160GB</p>
 <p><b>iPod touch 1st generation</b> 4GB 16GB 32GB</p>	 <p><b>iPod nano 4th generation (video)</b> 8GB 16GB</p>	 <p><b>iPod nano 1st generation</b> 1GB 2GB 4GB</p>
 <p><b>iPod touch 2nd generation</b> 8GB 16GB 32GB</p>	 <p><b>iPhone</b> <b>iPhone 3G</b> <b>iPhone 3GS</b></p>	



- "Made for iPod" means that the dock has been designed to connect specifically for the iPod and has been certified by the developer to meet Apple performance standards.
- Apple is not responsible for the operation of this device or its compliance with safety and regulatory standards.

**iPod is a trademark of Apple Inc., registered in the U.S. and other countries.**

**iPhone is a trademark of Apple Inc.**

## CONNECTING THE FM ANTENNA

1. Connect the FM antenna supplied to the FM ANTENNA terminal as a temporary measure.
2. Slowly move the antenna wire around until you find a location where reception is good, then fasten it to a wall or other rigid surface.

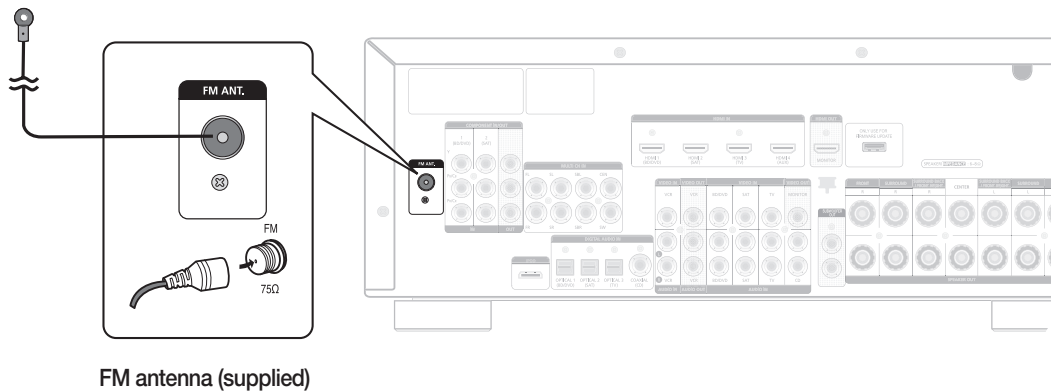

- Do not place the antenna cable close to the power cord. Keep it as far away as possible.
- If you experience poor FM reception, use an external antenna.

## CONNECTING AUX COMPONENTS

You can connect external devices you use for a short time (camcorder, game console, mobile equipment, etc.) to the front of this unit for convenience.

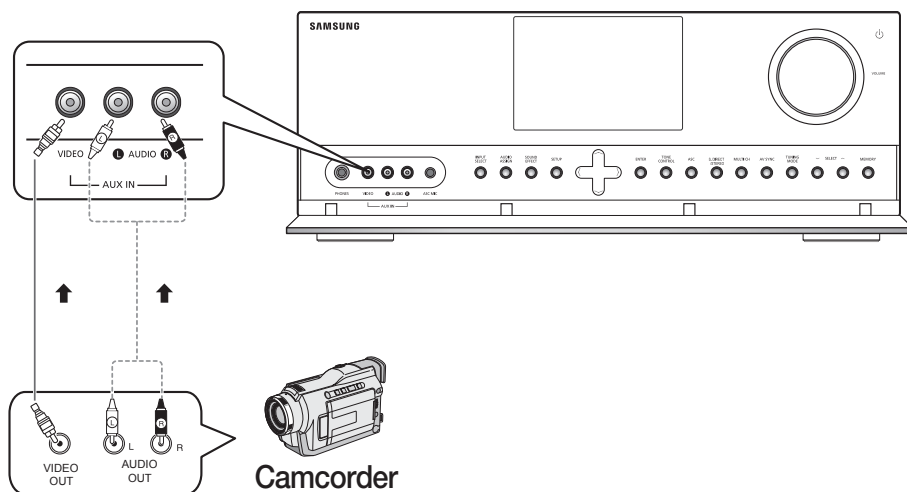

# Basic functions of your AV Receiver

## BEFORE USING THE AV RECEIVER

### Turning On/Off

Connect the power plug to the outlet.

Press the **POWER** button on the main unit for 2 seconds.

- This unit will be turned on or set to Standby mode.
- You can also turn the unit on/off by pressing the **POWER** button on the remote control.

### Remote control functions

You can operate your AMP (this AV receiver)/ TV and BD(Samsung only)/DVD player with this remote control.

See pages 52 ~ 53 for more details.

### To select a function

#### Method 1

Press the **INPUT SELECT** button.

- Each time you press this button, **FM** → **BD/DVD** → **SAT** → **TV** → **VCR** → **CD** → **AUX** → **7.1 MULTI CH** → **IPOD AUDIO** → **IPOD VIDEO** will be selected in turn.

#### Method 2

Press the **TUNING/CH**, **BD/DVD**, **SAT**, **TV**, **CD**, **MULTI CH**, **VCR/AUX** or **iPod** button.

- You can directly select the desired function.

## AUDIO SETUP

### Selecting a source device and connection jack

Select the external devices you have connected to the receiver.

1. Press the **SETUP/MENU** button.
  - Each time the button is pressed, the mode switches between **SETUP ENTER** and **SETUP OFF**.
2. Press the **ENTER** button to select **SETUP ENTER**.
3. Press the **▲▼** buttons to select **AUDIO SETUP**, and then press the **ENTER** or **▶** button.
4. Press the **▲▼** buttons to select a desired jack.
  - **Devices** switch as follows; **BD/DVD**, **SAT**, **TV**, **CD**

#### - To exit setup mode -

- Press the **SETUP/MENU** button.  
**SETUP OFF** appears on the display and Setup Mode is exited.

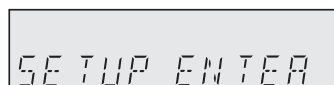

SETUP ENTER



AUDIO SETUP



- You can also use the **SETUP**, **▲**, **▼**, **<**, **>**, **ENTER** buttons on the front of your AV Receiver.

## SELECTING DIGITAL/ANALOG INPUT

You can listen to sound in 2 channel analog , Dolby Digital or DTS using this unit.

1. Press the **INPUT SELECT** button to select a desired function (BD/DVD, SAT,TV, CD, AUX). See page 28.
2. Press the **AUDIO ASSIGN** button on the remote control to select the external device you have connected.
  - Each time you press this button, the input mode changes as follows:



### • For BD/DVD function

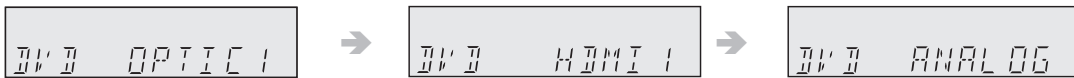

### • For SAT function

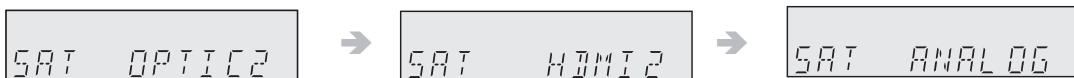

### • For TV function

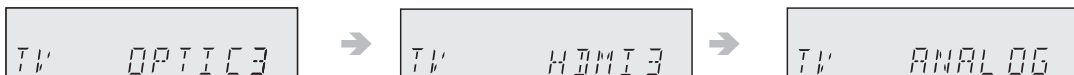

### • For CD function



### • For AUX function



- You can also change the input mode by pressing the **AUDIO ASSIGN** button on the front of your AV Receiver.
- You can enjoy Dolby Digital or DTS if you connect the digital audio output jack of an external audio component to the optical or coaxial digital audio input jack on the main unit.

# Setup

For your convenience, you can set this AV receiver's features for the best use.

## SETUP MENU TREE

Here's a quick look at how the setup menus are organized on your AV Receiver.

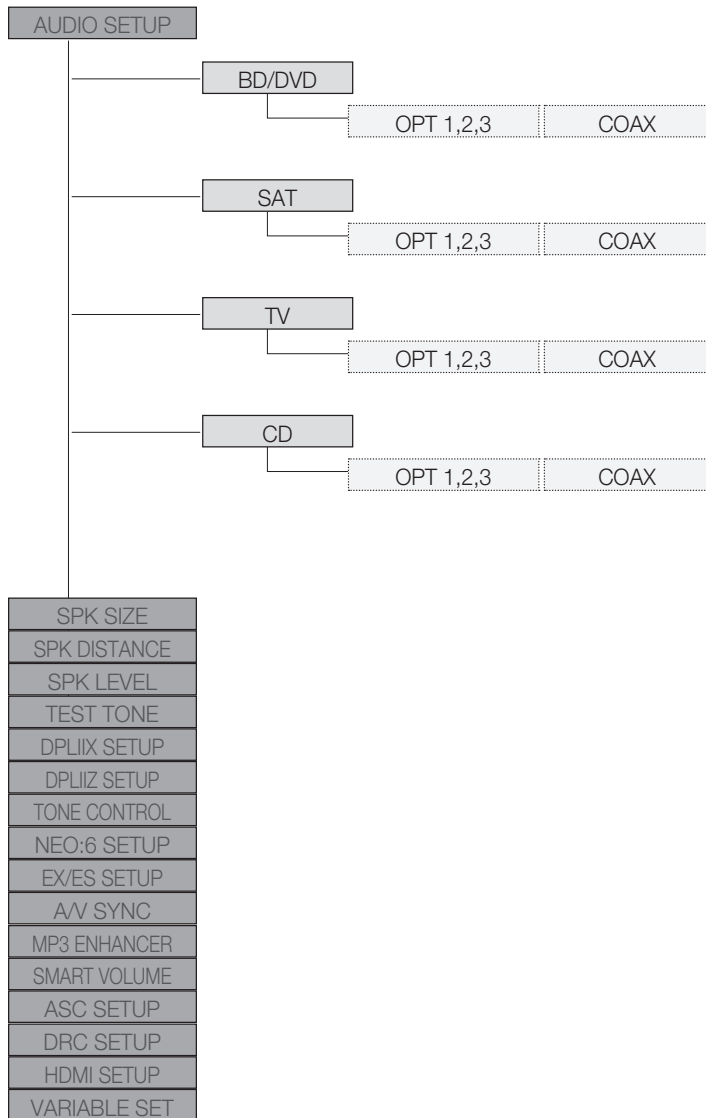

## SETUP MENU TREE (Continued)

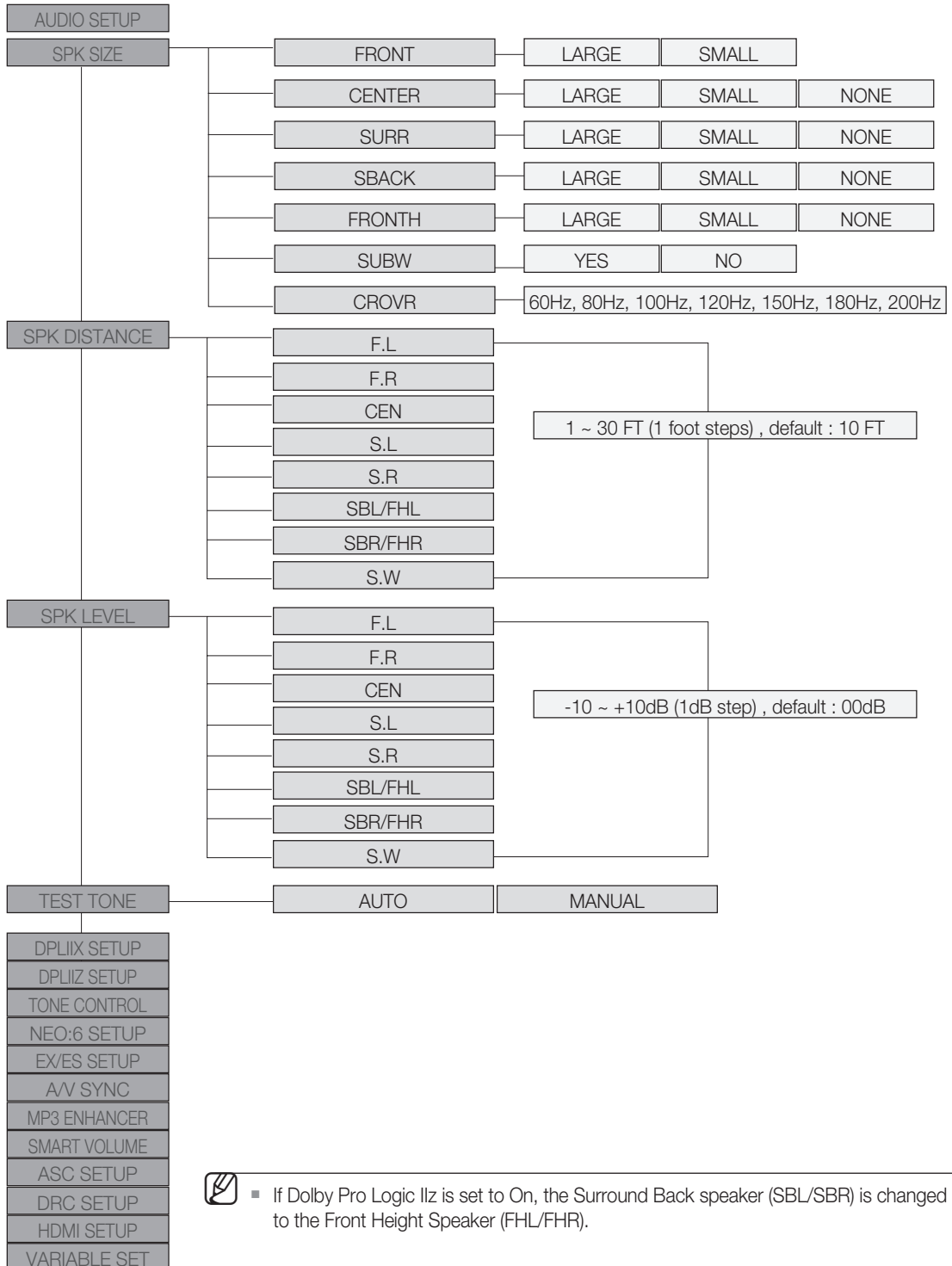

☞ If Dolby Pro Logic IIz is set to On, the Surround Back speaker (SBL/SBR) is changed to the Front Height Speaker (FHL/FHR).

# Setup

## SETUP MENU TREE (Continued)

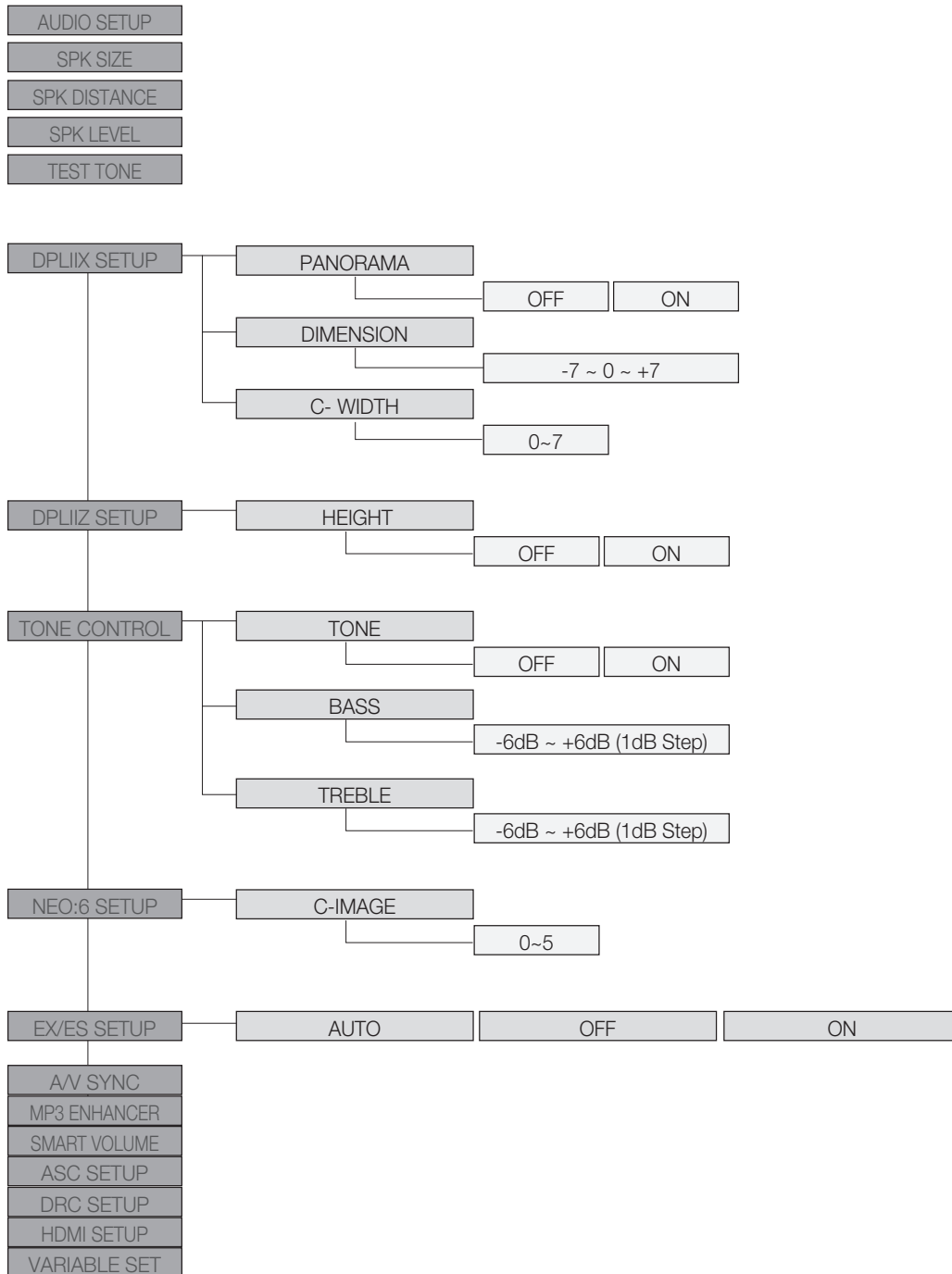



## SETUP MENU TREE (Continued)

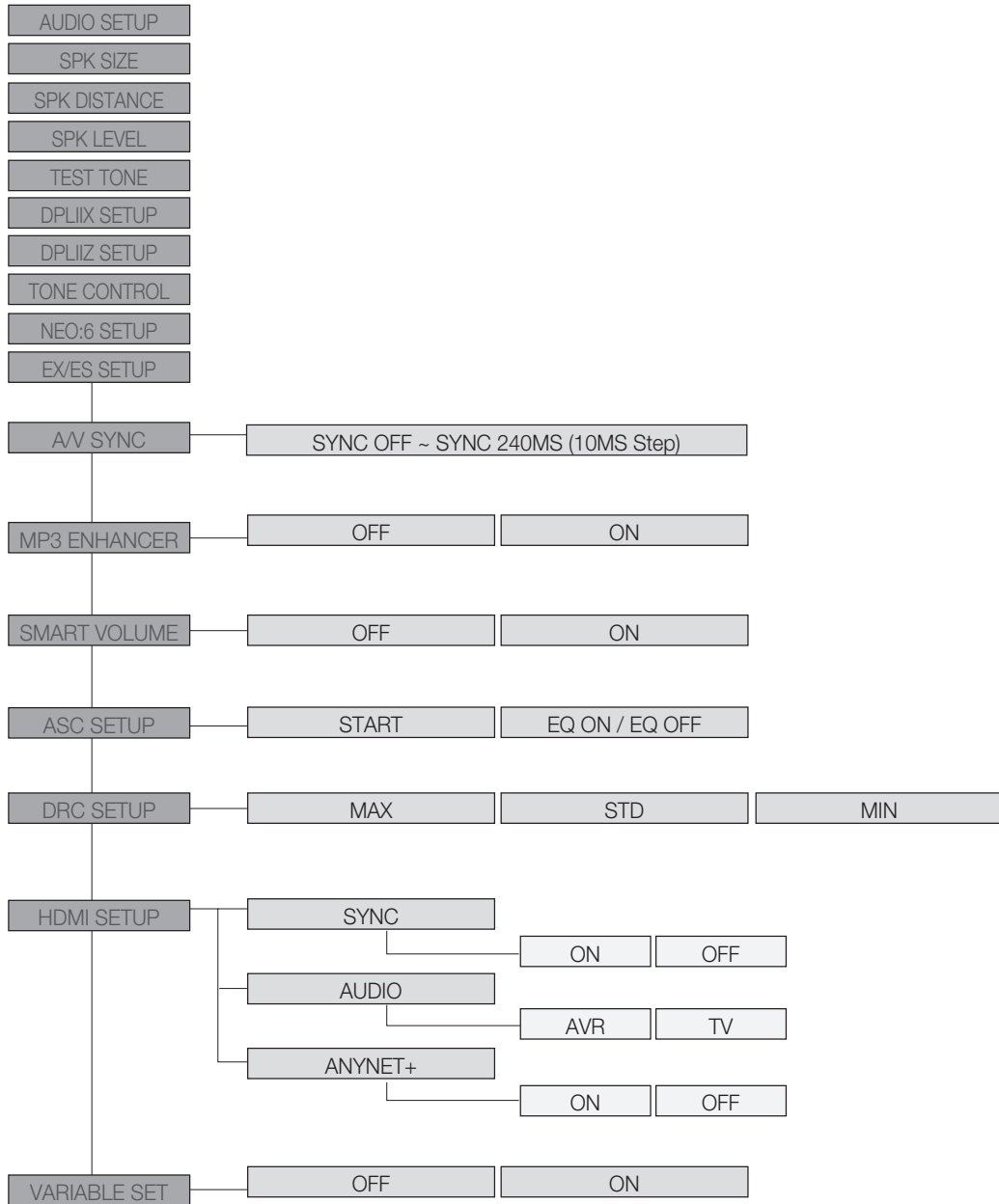

# Setup

## SETTING THE SPEAKER SIZE

Signal outputs and frequency response from the speaker will be adjusted according to your speaker configuration and whether certain speakers are used or not.

1. Press the **SETUP/MENU** button.
  - Each time the button is pressed, the mode switches between **SETUP ENTER** and **SETUP OFF**.
2. Press the **ENTER** button to select **SETUP ENTER**.
3. Press the **▲ ▼** buttons to select **SPK SIZE**, and then press the **ENTER** or **▶** button.
4. Press the **▲ ▼** buttons to select the speaker you want, and then press the **ENTER** or **▶** button.
  - Each time you press the **▲ ▼** buttons, FRONT → CENTER → SURR → SBACK → FRONTH → SUBW → CROVR will be selected in turn.
5. Press the **▲ ▼** buttons to set the mode (LARGE, SMALL etc.) for the selected speaker.
6. Repeat steps 3-5 to set the mode for each speaker.

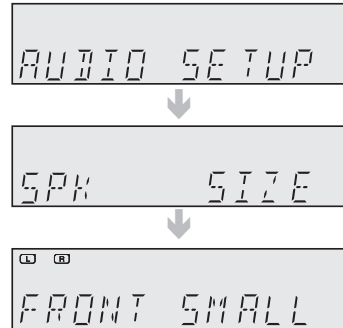

### - To exit setup mode -

- Press the **SETUP/MENU** button.  
**SETUP OFF** appears on the display and Setup Mode is exited.

### Setting the Speaker

SPEAKER	Possible Settings	Default Setting
FRONT (Front)	LARGE, SMALL	SMALL
CENTER (Center)	LARGE, SMALL, NONE	SMALL
SURR (Surround)	LARGE, SMALL, NONE	SMALL
SBACK (Surround Back)	LARGE, SMALL, NONE	SMALL
FRONTH (Front Height)	LARGE, SMALL, NONE	NONE
SUBW (Subwoofer)	YES, NO	YES
CROVR (Crossover Frequency)	60, 80, 100, 120, 150, 180, 200(Hz)	100Hz

- **LARGE** : Select when using large speakers. You can listen to full range sound.
- **SMALL** : Select this when using small speakers.
- **NONE** : Select when no speaker is used.
- **YES (subwoofer)** : Select when using the subwoofer speaker.
- **NO (subwoofer)** : Select when not using the subwoofer speaker.
- **CROVR** : Select the crossover frequency for the best bass response in your room.



- You can also use the **SETUP**, **▲**, **▼**, **<**, **>**, **ENTER** buttons on the front of your AV Receiver.
- When the Front speaker is only set to LARGE, you can select LARGE of other speakers.
- When the Surround speaker is only set to LARGE, you can select LARGE of SBACK (Surround Back) speaker.

## SETTING THE SPEAKER LISTENING DISTANCE

If the speakers cannot be placed at equal distances from the listening position, you can adjust the delay time of the audio signals from the center and surround speakers.

1. Press the **SETUP/MENU** button.
  - Each time the button is pressed, the mode switches between **SETUP ENTER** and **SETUP OFF**.
2. Press the **ENTER** button to select **SETUP ENTER**.
3. Press the **▲▼** buttons to select **SPK DISTANCE**, and then press the **ENTER** or **▶** button.
4. Press the **▲▼** buttons to select the speaker you want, and then press the **ENTER** or **▶** button.
  - Each time you press the **▲▼** buttons, F.L → F.R → CEN → S.L → S.R → SBL → SBR → S.W will be selected in turn.
5. Press the **▲▼** buttons to set the Speaker Distance.
  - For the FRONT LEFT, FRONT RIGHT, CENTER, SURR. LEFT, SURR. RIGHT, SURRBACK.LEFT, SURRBACK.RIGHT and SUBWOOFER Speakers, you can set the distance from the speaker to listening position between 1ft ~ 30ft (0.3~9.0m) in intervals of 1ft (0.3m).

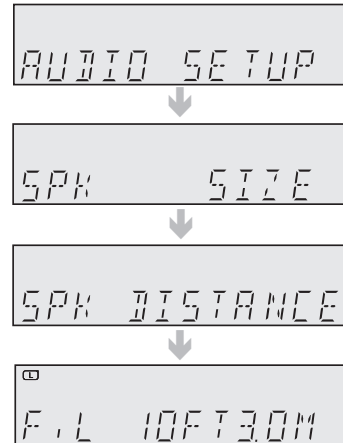

### - To exit setup mode -

- Press the **SETUP/MENU** button.  
**SETUP OFF** appears on the display and Setup Mode is exited.

### - Setting Speaker Distance -

Set the distance from the speaker to listening position in intervals of 1ft(0.3m).

- |                                     |  |
|-------------------------------------|--|
| • F.L (front left) : 1ft ~ 30ft     | • SW (subwoofer) : 1ft ~ 30ft            |
| • F.R (front right) : 1ft ~ 30ft    | • SBL (surround back left) : 1ft ~ 30ft  |
| • S.L (surround left) : 1ft ~ 30ft  | • SBR (surround back right) : 1ft ~ 30ft |
| • S.R (surround right) : 1ft ~ 30ft | • FHL (front height left) : 1ft ~ 30ft   |
| • CEN (center) : 1ft ~ 30ft         | • FHR (front height right) : 1ft ~ 30ft  |



- If the listening position is beyond the range of the speaker distance setup, set the speaker distance to the maximum.
- The distance range of the overall speaker system is determined based on the F.L(front left) speaker distance from the listening position.
- If Dolby Pro Logic IIz is set to On, the Surround Back speaker (SBL/SBR) is changed to the Front Height Speaker (FHL/FHR).

# Setup

## SETTING THE SPEAKER LEVEL

You can set the balance and level of speakers.

1. Press the **SETUP/MENU** button.
  - Each time the button is pressed, the mode switches between **SETUP ENTER** and **SETUP OFF**.
2. Press the **ENTER** button to select **SETUP ENTER**.
3. Press the **▲ ▼** buttons to select **SPK LEVEL**, and then press the **ENTER** or **▶** button.
4. Press the **▲ ▼** buttons to select the speaker you want, and then press the **ENTER** or **▶** button.
  - Each time you press this button, F.L → F.R → CEN → S.L → S.R → SBL → SBR → S.W will be selected in turn.
5. Press the **▲ ▼** buttons to set the Speaker Level mode.
  - You can adjust it from -10 to +10dB in 1 step increments.
  - The sound gets quieter at -10dB and louder at +10dB.

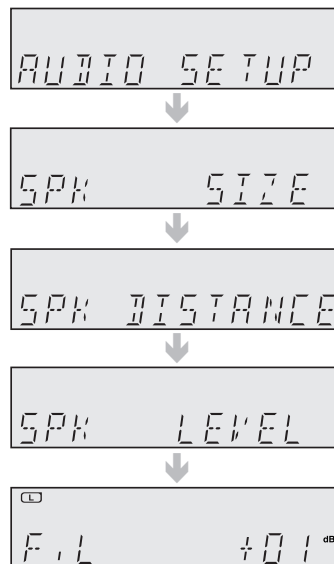

### - To exit setup mode -

- Press the **SETUP/MENU** button.  
**SETUP OFF** appears on the display and Setup Mode is exited.

### - Setting Speaker Level -

- |                                      |   |
|--------------------------------------|---|
| • F.L (front left) : -10 ~ +10dB     | • SW (subwoofer) : -10 ~ +10dB            |
| • F.R (front right) : -10 ~ +10dB    | • SBL (surround back left) : -10 ~ +10dB  |
| • S.L (surround left) : -10 ~ +10dB  | • SBR (surround back right) : -10 ~ +10dB |
| • S.R (surround right) : -10 ~ +10dB | • FHL (front height left) : -10 ~ +10dB   |
| • CEN (center) : -10 ~ +10dB         | • FHR (front height right) : -10 ~ +10dB  |



- If Dolby Pro Logic IIz is set to On, the Surround Back speaker (SBL/SBR) is changed to the Front Height Speaker (FHL/FHR).

## SETTING THE TEST TONE

Use the test tone to check the speaker connection status or level.

1. Press the **SETUP/MENU** button.
  - Each time the button is pressed, the mode switches between **SETUP ENTER** and **SETUP OFF**.
2. Press the **ENTER** button to select **SETUP ENTER**.
3. Press the **▲▼** buttons to select **TEST TONE**, and then press the **ENTER** or **▶** button.
4. Press the **▲▼** buttons to select the option you want, and then press the **ENTER** or **▶** button.
  - **AUTO** : Test signal will be automatically output as follows; F.L → CEN → S.W → F.R → S.R → SBR → SBL → S.L.
    - During test tone output, press the **▲▼** buttons to adjust the speaker output level from -10 to +10 dB by 1 step.
  - **MANUAL** : Enables you to adjust the output level of the speaker manually.
    - 1) Press the **ENTER** button to select the speaker you want. Each time you press the **ENTER** button, F.L → CEN → S.W → F.R → S.R → SBR → SBL → S.L will be selected in turn.
    - 2) Press the **▲▼** buttons to set the Test Tone mode you want. You can adjust the speaker output level from -10 to +10dB by 1 step. The sound gets quieter at -10dB and louder at +10dB.

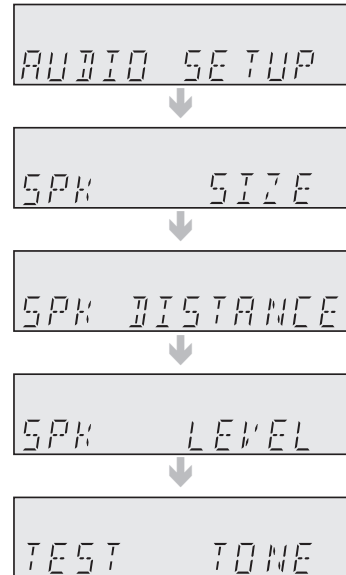

### - Test Tone Output -

- F.L (front left) : -10 ~ +10dB
- F.R (front right) : -10 ~ +10dB
- S L (surround left) : -10 ~ +10dB
- S.R (surround right) : -10 ~ +10dB
- CEN (center) : -10 ~ +10dB
- S.W (subwoofer) : -10 ~ +10dB
- SBL (surround back left) : -10 ~ +10dB
- SBR (surround back right) : -10 ~ +10dB

### - To stop test tone -

- Press the **SETUP/MENU** button once. **SETUP OFF** appears on the display and test tone stops.



- In the Dolby Pro Logic IIz mode; Test signal will be automatically output as follows : F.L → FHL → CEN → S.W → FHR → F.R → S.R.

# Setup

## SETTING DOLBY PRO LOGIC MODE

This mode provides 7.1 channel sound from 2 channel sources.

Press the **PROLOGIC** button on the remote control.

- **MOVIE** : Adds realism to the movie soundtrack.
- **MUSIC** : Provides 7.1 channel surround sound for digital, analog or existing stereo sources.
- **GAME** : Enhances the excitement of the game's sound.
- **MATRIX** : You will hear 7.1 channel surround sound.
- **PL (Pro Logic)** : You will experience a surround effect with 5.1 channel surround sound.

## SETTING DOLBY PRO LOGIC IIx

This function works only in Dolby Pro Logic IIx MUSIC mode.

1. Press the **SETUP/MENU** button.
  - Each time the button is pressed, the mode switches between **SETUP ENTER** and **SETUP OFF**.
2. Press the **ENTER** button to select **SETUP ENTER**.
3. Press the **▲▼** buttons to select **DPLIIX SETUP**, and then press the **ENTER** or **▶** button.
4. Press the **▲▼** buttons to select the option you want, and then press the **ENTER** or **▶** button.
  - **PANORAMA** : You can set it ON or OFF.  
(This mode extends the front stereo image to include the surround speakers for an exciting "wraparound" effect with side wall imaging.)
  - **DIMENSION** : You can set from -7 to +7.  
(Incrementally adjusts the sound field (DSP)from the front or surround.)
  - **C- WIDTH** : You can set from 0 to 7.  
(This sets the width of the center sound image. The higher the setting, the less sound comes from the center speaker.)

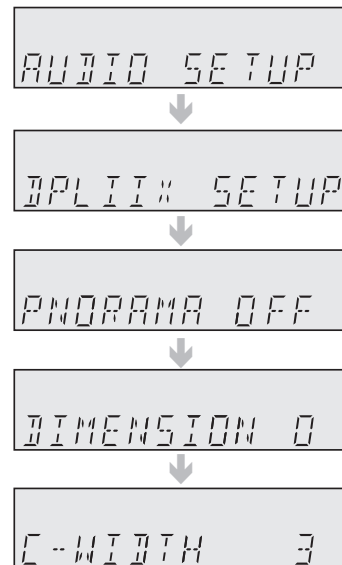

- PANORAMA, DIMENSION and CENTER WIDTH settings are enabled only if the mode is set to MUSIC.
- You cannot use Dolby Pro Logic IIx mode for multi channel signals such as Dolby Digital, Dolly Digital +, Dolby true HD, DTS, DTS-HD Master Audio.
- Pro Logic works only for PCM audio signals with sampling frequencies of 32KHz, 44KHz or 48KHz.
- When Dolby Pro Logic IIz is set ON, Dolby Pro Logic IIx can not be used.

## SETTING DOLBY PRO LOGIC IIz

Dolby Pro Logic IIz adds front height channels to surround sound.

1. Press the **SETUP/MENU** button.
  - Each time the button is pressed, the mode switches between **SETUP ENTER** and **SETUP OFF**.
2. Press the **ENTER** button to select **SETUP ENTER**.
3. Press the **▲▼** buttons to select **DPLIIz SETUP**, and then press the **ENTER** or **▶** button.
4. Press the **▲▼** buttons.
  - Each time you press this button, HEIGHT OFF → HEIGHT ON will be selected in turn.

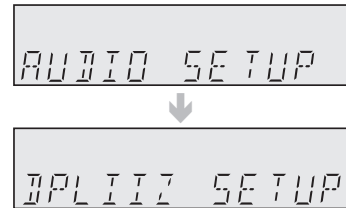

- If Dolby Pro Logic IIz is set to On, the Surround Back speaker in the speaker size mode is changed to NONE, the Front Height Speaker will be turned on. If Dolby Pro Logic IIz is set to OFF, the surround back speaker and front height speaker can't be turned to default setting.
- If you change Dolby Pro Logic IIz mode to Dolby Pro Logic IIx mode, first Dolby Pro Logic IIz will be turned off, second FRONTH in the speaker size mode will be turned off, lastly the Surround Back Speaker will be turned on.  
If you turn Dolby Pro Logic IIz on, FRONTH in the speaker size mode and the Surround Back Speaker can not be changed to NONE.

## SETTING TONE CONTROL

This will enable you to adjust the bass and treble level.

1. Press the **SETUP/MENU** button.
  - Each time the button is pressed, the mode switches between **SETUP ENTER** and **SETUP OFF**.
2. Press the **ENTER** button to select **SETUP ENTER**.
3. Press the **▲▼** buttons to select **TONE CONTROL**, and then press the **ENTER** or **▶** button.
4. Press the **▲▼** buttons to select the option you want, and then press the **ENTER** or **▶** button.
  - Each time you press this button, TONE → BASS → TREBLE will be selected in turn.
5. Press the **▲▼** buttons to set the Tone Control mode you want.
  - If it is set to **TONE OFF**, the Tone Control function will be disabled.
  - You can adjust it from -6 to +6dB by 1 step.
  - The sound gets quieter at -6dB and louder at +6dB.

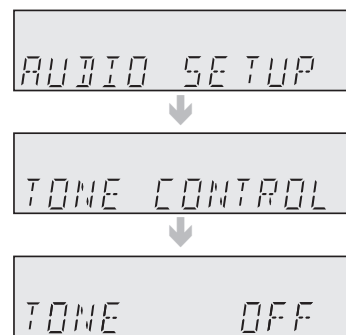

### - To exit setup mode -

- Press the **SETUP/MENU** button.  
**SETUP OFF** appears on the display and Setup Mode is exited.



- The Tone Control function can be applied to all channels except for the subwoofer.

# Setup

## SETTING NEO:6 MODE

You can play back 2 channel sound over 6.1 channels when enjoying music or a movie.

1. Press the **SETUP/MENU** button.
  - Each time the button is pressed, the mode switches between **SETUP ENTER** and **SETUP OFF**.
2. Press the **ENTER** button to select **SETUP ENTER**.
3. Press the **▲▼** buttons to select **NEO:6 SETUP**, and then press the **ENTER** or **▶** button.
4. Press the **▲▼** buttons to set the C-IMAGE mode you want.  
You can set **C-IMAGE** from 0 to 5  
This parameter adjusts the height of the center image through the front and center speakers.  
"0" is the lowest while "5" is the highest.



### - To exit setup mode-

- Press the **SETUP/MENU** button.  
**SETUP OFF** appears on the display and Setup Mode is exited.



- NEO:6 mode cannot be used with Dolby Digital, Dolly Digital +, Dolby true HD, DTS, DTS-HD Master Audio.
- Pro Logic works only for PCM audio signals with sampling frequencies of 32KHz, 44KHz or 48KHz.



## SETTING EX/ES MODE

When surround back speakers are connected, you can listen to 6.1 or 7.1 multi-channel sound using the built-in Dolby Digital Surround EX or DTS ES decoder. This function works when a Dolby Digital or DTS source (such as a DVD player) is input, and does not work with L.PCM and Dolby Digital 2 channel sources.

1. Press the **SETUP/MENU** button.
  - Each time the button is pressed, the mode switches between **SETUP ENTER** and **SETUP OFF**.
2. Press the **ENTER** button to select **SETUP ENTER**.
3. Press the **▲▼** buttons to select **EX/ES SETUP**, and then press the **ENTER** or **▶** button.
4. Press the **▲▼** buttons to set the EX/ES mode you want.
  - **AUTO** : If the unit receives an audio signal that it can recognize, it will select an optimal decoder for playback in 6.1/7.1 channels. If the amplifier does not recognize the audio signal, it will not play in 6.1/7.1 channel automatically.
  - **ON** : Dolby Digital or DTS signal will be played in 6.1 / 7.1 channel using Dolby Digital Surround EX / DTS ES decoder.
  - **OFF** : Dolby Digital Surround EX / DTS ES decoder will not be used for playback.



### - To exit setup mode-

- Press the **SETUP/MENU** button.  
**SETUP OFF** appears on the display and Setup Mode is exited.



- You cannot use DTS-ES without surround back speakers connected.

# Setup

## AV SYNC

Video may look slower than the audio if it is connected to a digital TV. If this occurs, adjust the audio delay time to match the video.

1. Press the **SETUP/MENU** button.
  - Each time the button is pressed, the mode switches between **SETUP ENTER** and **SETUP OFF**.
2. Press the **ENTER** button to select **SETUP ENTER**.
3. Press the **▲▼** buttons to select **A/V SYNC**, and then press the **ENTER** or **▶** button.
4. Press the **▲▼** buttons to set the A/V Sync mode you want.
  - You can adjust it from OFF to 240MS in 10MS steps.

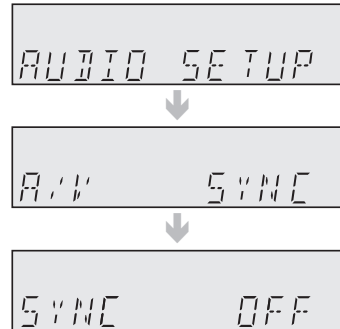

## MP3 ENHANCER

This also helps enhance your sound experience (ex. mp3 music). Use this if you want to hear better sound from a low quality mp3 source.

1. Press the **SETUP/MENU** button.
  - Each time the button is pressed, the mode switches between **SETUP ENTER** and **SETUP OFF**.
2. Press the **ENTER** button to select **SETUP ENTER**.
3. Press the **▲▼** buttons to select **MP3 ENHANCER**, and then press the **ENTER** or **▶** button.
4. Press the **▲▼** buttons to select **ON** or **OFF**.

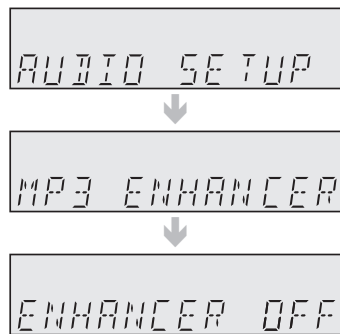

## SMART VOLUME

This will regulate and stabilize the volume level against a drastic volume change when changing channels or during a scene transition.

1. Press the **SETUP/MENU** button.
  - Each time the button is pressed, the mode switches between **SETUP ENTER** and **SETUP OFF**.
2. Press the **ENTER** button to select **SETUP ENTER**.
3. Press the **▲▼** buttons to select **SMART VOLUME**, and then press the **ENTER** or **▶** button.
4. Press the **▲▼** buttons to select **ON** or **OFF**.



## ASC (AUTO SOUND CALIBRATION) SETUP

By setting the ASC function just once when you relocate or install the unit, you can have the unit automatically recognize the distance between speakers, levels between channels, and frequency characteristics to create a 7.1-channel sound field optimized for your environment.

### - Before Setting -

1. Plug the ASC microphone into the **ASC MIC** jack.
2. Place the ASC microphone at the listening position.
3. Press the **ASC** button on the front panel, and then press the **ENTER** button.

1. Press the **SETUP/MENU** button.
  - Each time the button is pressed, the mode switches between **SETUP ENTER** and **SETUP OFF**.

AUDIO SETUP

2. Press the **ENTER** button to select **SETUP ENTER**.

ASC SETUP

3. Press the **▲▼** buttons to select **ASC SETUP**, and then press the **ENTER** or **▶** button.

ASC START

4. Press the **▲▼** buttons to select **ASC START**, and then press the **ENTER** button.
  - To create the optimal 7.1 channel sound field, the selections are in the following sequence:

**L → C → R → SR → SBR → SBL → SL → SW**

- **EQ ON** : The ASC(Auto Sound Calibration) EQ mode is set to on.
- **EQ OFF**: The ASC(Auto Sound Calibration) EQ mode is set to off.

5. If you see a **ASC READY** message on the screen, press the **ENTER** button to apply the measurement value. And then unplug the ASC microphone.

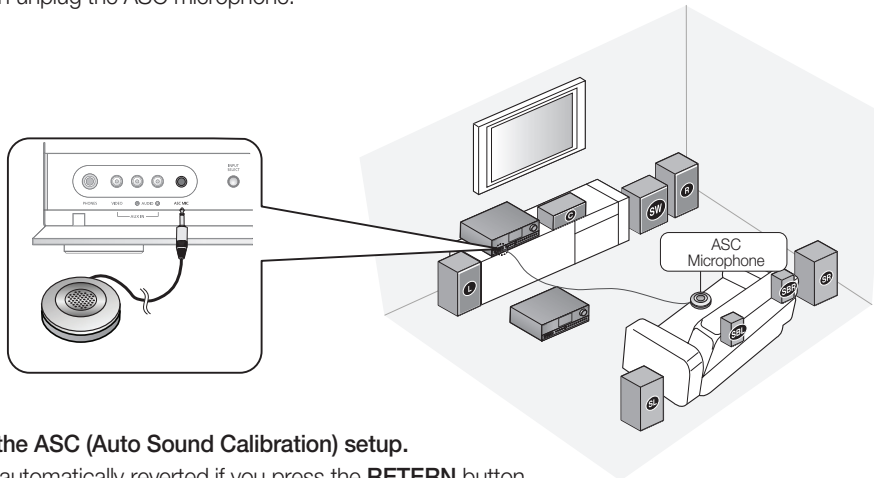

### To cancel the ASC (Auto Sound Calibration) setup.

This will be automatically reverted if you press the **RETERN** button.

\* If ASC error occurs, see "ASC Error List" on page 56.



- Setting the ASC function takes about 3 minutes.
- Because the volume level of the tone is fixed during the ASC setup, you cannot adjust the volume using the volume control.
- If the ASC microphone is disconnected during the ASC setup, the setup will be canceled.
- You can also press the **ASC** button on the remote control to use this function.
- If Dolby Pro Logic IIz is set to ON, the selection are in the following sequence : FL → CEN → FR → SR → SL → SW.

# Setup

## DRC SETUP

You can use this function to enjoy Dolby Digital sound when watching movies at low volume at night. DRC compresses the audio to make the loudest sounds quieter and the quietest sounds louder.

1. Press the **SETUP/MENU** button.
  - Each time the button is pressed, the mode switches between **SETUP ENTER** and **SETUP OFF**.
2. Press the **ENTER** button to select **SETUP ENTER**.
3. Press the **▲▼** buttons to select **DRC SETUP**, and then press the **ENTER** or **▶** button.
4. Press the **▲▼** buttons to set the DRC Setup mode you want.
  - **STD** : Sets DRC effect to standard.    • **MAX** : Sets DRC effect to maximum.
  - **MIN** : Sets DRC effect to minimum.

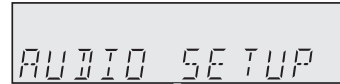

AUDIO SETUP

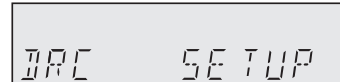

DRC SETUP

## HDMI SETUP

Use this if you want to receive audio from HDMI connected external devices.

1. Press the **SETUP/MENU** button.
  - Each time the button is pressed, the mode switches between **SETUP ENTER** and **SETUP OFF**.
2. Press the **ENTER** button to select **SETUP ENTER**.
3. Press the **▲▼** buttons to select **HDMI SETUP**, and then press the **ENTER** or **▶** button.
4. Press the **▲▼** buttons to select the option you want, and then press the **ENTER** or **▶** button.
5. Press the **▲▼** buttons to set the HDMI Setup mode you want.
  - **HDMI AUDIO** : AVR(Audio Video Receiver), TV  
This preference determines whether audio received at the HDMI IN is output by the HDMI OUT.  
If you want to listen to audio from an HDMI connected external device through your HDMI connected TV's speakers, set it to TV. Otherwise, leave it on AVR to listen to audio from the A/V receiver.
    - AVR : HDMI audio is not output                      - TV : HDMI audio is output
  - **HDMI ANYNET+** : ON, OFF  
Anynet+ is a function that enables you to control other Samsung Devices with your Samsung TV's remote control.
    - ON : Anynet+ is enabled.                                      - OFF : Anynet+ is disabled.
  - **HDMI SYNC** : ON, OFF  
The AV receiver can be set to automatically correct any delay between the video and the audio, based on the data from the connected TV.
    - ON : HDMI Sync is enabled.                                      - OFF : HDMI Sync is disabled.



- HDMI Audio is enabled only if both the HDMI INPUT and HDMI OUT are connected properly and working normally.
- This function works only if your HDMI-compatible TV supports HDMI Sync.

## VARIABLE SET (Low Power Consumption SETUP)

This function enhances electric power efficiency.

1. Press the **SETUP/MENU** button.
  - Each time the button is pressed, the mode switches between **SETUP ENTER** and **SETUP OFF**.
2. Press the **ENTER** button to select **SETUP ENTER**.
3. Press the **▲▼** buttons to select **VARIABLE SET**, and then press the **ENTER** or **▶** button.
4. Press the **▲▼** buttons to select **ON** or **OFF**.
  - **ON** : This is Samsung's electric power efficiency function, you can save about 30 % for power consumption.
  - **OFF** : Normal power efficiency function.



- This function is not available after the Tone Control, Speaker Level, SFE mode or ASC is changed from the factory setting.

## USING THE SURROUND MODES

### Using the SOUND EFFECT button on the front of the main unit

#### Selecting the DPLIIX mode

1. Press the **SOUND EFFECT** button to select **DPLIIX**.
  - Each time you press this button, **DPLIIX** → **NEO:6** → **SFE** will be selected in turn.
2. Press the **UP/DOWN** (  $\wedge$ ,  $\vee$  ) button.
  - Each time you press the **UP/DOWN** (  $\wedge$ ,  $\vee$  ) button, **MUSIC** → **GAME** → **MATRIX** → **PL** → **MOVIE** will be selected in turn.
  - You can also select the DPLIIX mode by pressing the **PROLOGIC** button on the remote control.

#### Selecting the NEO:6 mode

1. Press the **SOUND EFFECT** button briefly to select **NEO:6**.
  - Each time you press this button, **DPLIIX** → **NEO:6** → **SFE** will be selected in turn.
2. Press the **UP/DOWN** (  $\wedge$ ,  $\vee$  ) button.
  - Each time you press the **UP/DOWN** (  $\wedge$ ,  $\vee$  ) button, **MUSIC** → **CINEMA** will be selected in turn.
  - You can also select the NEO:6 mode by pressing the **NEO : 6** button on the remote control.

#### Selecting the SFE mode

1. Press the **SOUND EFFECT** button to select **SFE**.
  - Each time you press this button, **DPLIIX** → **NEO:6** → **SFE** will be selected in turn.
2. Press the **UP/DOWN** (  $\wedge$ ,  $\vee$  ) button.
  - Each time you press the **UP/DOWN** (  $\wedge$ ,  $\vee$  ) button, **STEREO** → **HALL 1** → **HALL 2** → **J.CLUB** → **CHURCH** → **ROCK** → **CLASSIC** → **LIVE** → **GAME** → **MOVIE** → **CONCERT** → **STADIUM** will be selected in turn.
  - You can also select the SFE mode by pressing the **DSP** button on the remote control.



- You cannot use Dolby Pro Logic IIx mode for multi channel signals such as Dolby Digital and DTS.
- Pro Logic works only for BITSTREAM audio signals with sampling frequencies of 32KHz, 44KHz or 48KHz.
- If you turn Dolby Pro Logic IIz on, the Dolby Pro Logic IIx mode is only available MOVIE.

### Using the S.DIRECT/STEREO button on the front of the main unit

Press the **S.DIRECT/STEREO** button.

- Each time the button is pressed, the mode switches between the S. DIRECT mode and the STEREO mode.
- **S.DIRECT** : Outputs 2 CH PCM audio signal without any signal processing, providing higher audio quality. This is useful for obtaining the best sound from a connected CD player.
- **STEREO** : Outputs sound of the selected source in 2 CH stereo.

# Operation

## USING THE SURROUND MODES (Continued)

### Surround Mode and Input Signal Chart

o = active, – = inactive

Surround Mode	Input Signal	Decoding	Output Channel					Display Information	
			L/R	C	SL SR	SBL SBR	SUBW	Display Signal Format	Channel Status
DOLBY	Dolby D Surr. EX	Dolby Digital 5.1	o	o	o	o	o	DIGITAL	L, C, R, SL, SR, SBL, SBR, SW
	Dolby D (5.1ch)	Dolby Digital 5.1	o	o	o	–	o	DIGITAL	L, C, R, SL, SR, SW
	Dolby D Surr. EX	Pro Logic IIz	o	o	o	o	o	DIGITAL	L, C, R, SL, SR, SBL, SBR, SW
	Dolby D (5.1ch)	Pro Logic IIz	o	o	o	o	o	DIGITAL	L, C, R, SL, SR, SBL, SBR, SW
	Dolby D (2ch)	Pro Logic IIx(z)	o	o	o	o	o	DIGITAL	L, C, R, SL, SR, SBL, SBR, SW
	Dolby D (2ch Surr)	Pro Logic IIx(z)	o	o	o	o	o	DIGITAL	L, C, R, SL, SR, SBL, SBR, SW
	L.PCM (Audio)	Pro Logic IIx(z)	o	o	o	o	o	L.PCM	L, C, R, SL, SR, SBL, SBR, SW
Analog	Pro Logic IIx(z)	o	o	o	o	o	Analog	L, C, R, SL, SR, SBL, SBR, SW	
NEO:6	L.PCM (Audio)	Neo:6	o	o	o	o	o	L.PCM	L, C, R, SL, SR, SBL, SBR, SW
	Analog	Neo:6	o	o	o	o	o	Analog	L, C, R, SL, SR, SBL, SBR, SW
	Dolby D (2ch)	Neo:6	o	o	o	o	o	DIGITAL	L, C, R, SL, SR, SBL, SBR, SW
	Dolby D (2ch Surr)	Neo:6	o	o	o	o	o	DIGITAL	L, C, R, SL, SR, SBL, SBR, SW
SFE	Dolby D (2ch)	DD+SFE	o	o	o	–	o	DIGITAL	L, C, R, SL, SR, SBL, SBR, SW
	Dolby D (2ch Surr)	DD+SFE	o	o	o	–	o	DIGITAL	L, C, R, SL, SR, SBL, SBR, SW
	L.PCM (Audio)	SFE	o	o	o	–	o	L.PCM	L, C, R, SL, SR, SBL, SBR, SW
	Analog	SFE	o	o	o	–	o	Analog	L, C, R, SL, SR, SBL, SBR, SW
EX/ES	Dolby D Surr. EX	Dolby Digital EX	o	o	o	o	o	DIGITAL	L, C, R, SL, SR, SBL, SBR, SW
	Dolby D (5.1ch)	Dolby Digital EX	o	o	o	o	o	DIGITAL	L, C, R, SL, SR, SBL, SBR, SW
	DTS-ES	DTS-ES	o	o	o	o	o	dts, ES	L, C, R, SL, SR, SBL, SBR, SW
	DTS (5.1ch)	DTS-ES	o	o	o	o	o	dts	L, C, R, SL, SR, SBL, SBR, SW
STEREO	Dolby D (2ch)	Stereo	o	–	–	–	o	DIGITAL	L, R, SW
	Dolby D (2ch Surr)	Stereo	o	–	–	–	o	DIGITAL	L, R, SW
	L.PCM (Audio)	Stereo	o	–	–	–	o	L.PCM	L, R, SW
	L.PCM 96KHz	Stereo	o	–	–	–	o	L.PCM	L, R, SW
	Analog	Stereo	o	–	–	–	o	Analog	L, R, SW
True-HD	True-HD	True-HD	o	o	o	o	o	True-HD	L, C, R, SL, SR, SBL, SBR, SW
Dolby Digital +	Dolby Digital +	Dolby Digital +	o	o	o	o	o	Dolby Digital +	L, C, R, SL, SR, SBL, SBR, SW
DTS-HD	Master Audio	Master Audio	o	o	o	o	o	DTS-HD	L, C, R, SL, SR, SBL, SBR, SW
	High Resolution	High Resolution	o	o	o	o	o	DTS-HD	L, C, R, SL, SR, SBL, SBR, SW

- **L/R** : front speaker (left/right)
- **C** : center speaker
- **SL/SR** : surround speaker (left/right)
- **SBL/SBR** : surround back speaker (left/right)
- **SW** : subwoofer



- Channel status displays are dependent on the speaker configuration.
- SFE mode works with 2-ch signals.
- If Dolby Pro Logic IIz is set to On, the Surround Back speaker(SBL/SBR) is changed to the Front Height Speaker(FHL/FHR), Dolby true HD, Dolby plus, DTS-HD Master Audio ,SFE and NEO:6 will be output 5.1 channel.

## USING THE SUBWOOFER SELECTION BUTTON

You can set the subwoofer to on/off.

Press the **SUBWOOFER** button.

## LISTENING TO THE RADIO

You can listen to the radio by using either automatic or manual tuning.

1. Press the **INPUT SELECT** button to select **FM**.
2. Select a frequency (radio broadcast).
  - Preset tuning :  
Press the **◀◀, ▶▶** buttons on the remote control to select the preset frequency.
  - Manual tuning 1 (Automatic tuning):  
Press and hold the **TUNING/CH ( √, ^ )** buttons on the remote control to automatically tune in a frequency.
  - Manual tuning 2 :  
Press the **TUNING/CH ( √, ^ )** buttons on the remote control to increase or decrease the frequency step by step.



- You can also use the **SELECT ( √, ^ )** button on the main unit to change the radio frequency.

### To Listen in mono/stereo

Press the **MO/ST** button on the remote control.

- Each time you press this button, **STEREO** or **MONO** will be selected in turn.
- If you select **MONO** in an area with weak reception, it will help to reduce noise.
- This function works only with the remote control.

## Presetting radio stations

You can preset up to 30 FM stations.

E.g.: Setting station FM 89.10 in preset 2.

1. Press the **INPUT SELECT** button to select **FM**.
2. Press the **TUNING/CH ( √, ^ )** buttons on the remote control to select 89.10.
  - Refer to step 2 above to tune in automatically and manually.
3. Press the **MEMORY** button on the main unit.
  - You can also use the **TUNER MEMORY** button on the remote control.
  - Tuner number will blink on the display.
4. Press the **TUNING/CH ( √, ^ )** buttons on the remote control to select preset 2.
  - You can select from presets 1 to 30.
5. Press the **MEMORY** button on the main unit.
  - Tuner number will disappear and station 89.10 will be saved in preset 2.
6. To preset other stations, repeat steps 2 to 5.

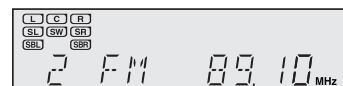
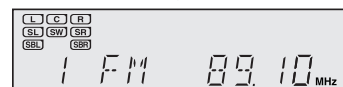
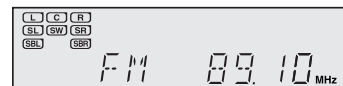

### To Listen to Preset Station

- Press the **TUNING MODE** button to select **PRESET** and press the **SELECT ( √, ^ )** buttons.

# Operation

---

## USING AN iPod

---

You can enjoy playback of your iPod using the supplied remote control.

### Listening to Music (iPod audio function)

---

You can play music files stored in the iPod player by connecting it to the AV receiver.

1. Connect the iPod dock connector to the iPod jack on the AV Receiver.
2. Place the iPod in the dock.
  - Your iPod is automatically turned on.
3. Press the **INPUT SELECT** button on the remote control to select **IPOD AUDIO** mode.
4. Press the **PLAY** button on the remote control to play.
  - The AV receiver starts playing from the first track of the iPod player.
5. You can use the remote control to control simple playback functions such as the **PLAY**, **PAUSE**, **STOP**, **SKIP (◀▶)** buttons.

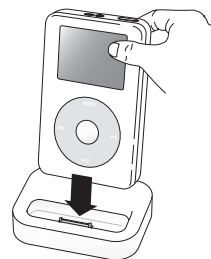

- See page 26 for compatible iPods.  
Compatibility depends on the software version of your iPod.
- You can also select iPod by pressing the **iPod** button on the remote control.



## USING AN iPod (Continued)

### Watching a Movie (iPod Video function)

You can play video files stored in the iPod player on a TV by connecting it to the AV receiver.

1. Connect the iPod dock connector to the iPod jack on the AV receiver.
2. In the iPod screen, move to **Videos > Settings** and set the **TV Out** option to **On**.
3. Place the iPod in the dock.
4. Press the **INPUT SELECT** button on the remote control to select **IPOD VIDEO** mode.
5. Set the AV IN option of the TV connected to the AV receiver to **COMPOSITE**.

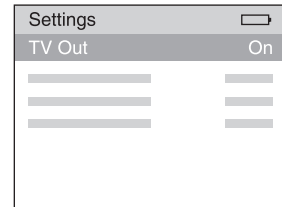

<iPod Screen>

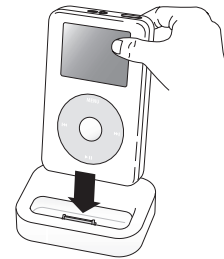

Follow the iPod onscreen guide through the following steps.

6. Press the **▲, ▼** buttons on the remote control to select **Videos** and press the **ENTER** button.
7. Press the **▲, ▼** buttons on the remote control to select **Movies** and press the **ENTER** button.
8. Press the **▲, ▼** buttons to select the file to play and press the **ENTER** button.
  - The iPod's video files will be played on the TV screen.
9. You can use the remote control to control simple playback functions such as the **PLAY, PAUSE, STOP, SKIP (◀◀, ▶▶)** buttons.
  - If you press the **PREV** button within 3 seconds after the playback, the player will stop playing and return to the list screen.  
If you press the **PREV** button 3 seconds or later after the playback, the player will move to the start screen of the current file.
  - Press the **STOP** button to stop playing and return to the list screen.
  - Press the **RETURN** button to return to the previous menu.

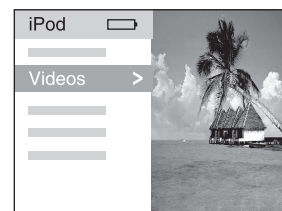

<iPod Screen>



- You must have the VIDEO (Monitor or VCR) output connected to your TV to view iPod video.
- See page 26 for compatible iPods.  
Compatibility depends on the software version of your iPod.
- When the current file is played to the end, the next file will not be played automatically.  
To play the next file, select a file to play in the list screen of the iPod player.
- No other screen than the playback one will appear on the TV screen. Check other screens on the iPod player.

# Operation

## CONVENIENT FUNCTIONS

### Sleep timer function

You can set the time that this unit will shut itself off.

Press the **SLEEP** button.

- SLEEP : OFF → 15 → 30 → 45 → 60 → 90 → 120 M (MIN) will be selected in turn.



#### To check sleep timer

Press the **SLEEP** button.

- The remaining time before this unit will shut itself off is shown on the display.
- Pressing the button again changes the sleep time from what you set previously.

#### To cancel sleep timer

- Press the **SLEEP** button until **SLEEP OFF** appears on the display.

### Mute function

This function is useful when answering a doorbell or telephone call.

Press the **MUTE** button.

- MUTE appears on the display.



#### To output sound again

Press the **MUTE** button again.

- MUTE will disappear and sound will output.

### Adjust the display

You can adjust the brightness of the display.

Press the **DIMMER** button.

- Each time you press this button, the brightness changes as follows :  
Dark → Bright.

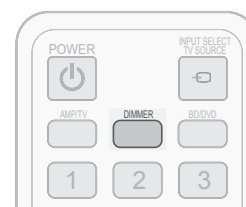

- SLEEP, Mute and the Adjust Display functions can only be operated with the remote control.

## Reset function

### When the Power is on,

1. Press the **MUTE** button.
  - **MUTE** appears on the display.
2. Press the **9** button five times and then press the **ENTER** button.
  - **INITIAL : NO** appears on the display.
3. Press the **▲▼** buttons to select **YES**.
  - The unit will turn off after 5 seconds.

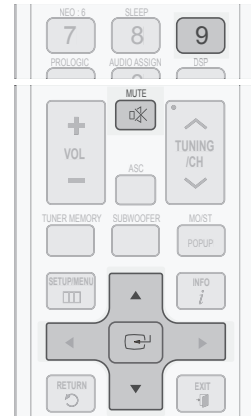

### When the Power is Off,

1. Press and hold the **MEMORY** button on the front of your AV Receiver for longer than 5 seconds.
  - **POWER LED** will blink one time.

- 
  - Using the RESET function will erase all stored settings.
  - Do not use this unless necessary.

## Using headphones

Use headphones (not supplied) for private listening pleasure.

Connect the headphones to the headphone (PHONES) jack and listen to music.

- 
  - Do not turn the volume up too high when you use headphones as it may damage your hearing.

## SOFTWARE UPGRADE

Samsung may offer upgrades for AV Receiver's firmware in the future.

Please visit [Samsung.com](http://Samsung.com) or contact the Samsung call centre to receive information about downloading upgrades and using a USB drive. Upgrades will be possible by connecting a USB drive to the USB port located on your AV Receiver.

- 
  - Insert a USB drive containing the firmware upgrade into the USB port on the back of the main unit.
  - Please be careful to not disconnect the power or remove the USB drive while upgrades are being applied. The main unit will turn off automatically after completing the firmware upgrade. When software is upgraded, settings you have made will return to their default (factory) settings. We recommend you write down your settings so that you can easily reset them after the upgrade.
  - If you failed software upgrade, it is strongly recommended whole USB data format to FAT16 and retry software upgrade.
  - The NTFS USB File System can not be supported.
  - Depending on the manufacturer, the USB may not be supported.

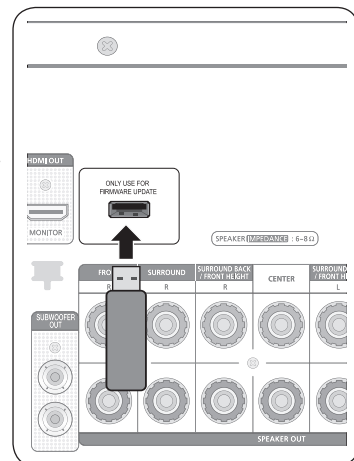

# Miscellaneous

---

## OPERATING YOUR TV WITH THE REMOTE CONTROL

---

1. Press the **POWER** button to turn on the TV.
2. Press the **AMP/TV** button to set the remote to TV mode.
3. Point the remote control toward the TV.
4. While holding down the **POWER** button, enter the code corresponding to your brand of TV.
  - If there is more than one code listed for your TV in the table, enter one at a time to determine which code works.
  - If the code matches the TV's code, the TV will be turned off.
5. If TV is turned on or off when you press the **POWER** button of the remote control, the setting is completed.
  - You can use the TV POWER, VOLUME, CHANNEL, MENU and Numeric buttons (0~9).



- The remote control may not work on some brands of TVs. Also, some operations may not be possible depending on your brand of TV.
- The remote control will work with Samsung TVs by default.

## OPERATING YOUR TV WITH THE REMOTE CONTROL (Continued)

### TV Brand Code List

Brand	Code Number	Brand	Code Number	Brand	Code Number
Admiral (M.Wards)	056, 057, 058	Luxman	018	Sylvania	018, 040, 048, 054, 059, 060, 062
A Mark	001, 015	LXI (Sears)	019, 054, 056, 059, 060, 062, 063, 065, 071	Symphonic	061, 095, 096
Anam	001, 002, 003, 004, 005, 006, 007, 008, 009, 010, 011, 012, 013, 014	Magnavox	015, 017, 018, 048, 054, 059, 060, 062, 072, 089	Tatung	006
AOC	001, 018, 040, 048	Marantz	040, 054	Techwood	018
Bell & Howell (M.Wards)	057, 058, 081	Matsui	054	Teknika	003, 015, 018, 025
Brocsonic	059, 060	MGA	018, 040	TMK	018, 040
Candle	018	Mitsubishi/MGA	018, 040, 054, 059, 060, 075, 101	Toshiba	019, 057, 063, 071, 101, 107, 109, 110, 111, 113
Cetronic	003	MTC	018	Vidtech	018
Citizen	003, 018, 025	NEC	018, 019, 020, 040, 059, 060	Videch	059, 060, 069
CINEMA	097	Nikei	003	Wards	015, 017, 018, 040, 048, 054, 060, 064
Classic	003	Onking	003	Yamaha	018
Concerto	018	Onwa	003	York	040
Contec	046	Panasonic	006, 007, 008, 009, 054, 066, 067, 073, 074	Yupiteru	003
Coronado	015	Penney	018	Zenith	058, 079
Craig	003, 005, 061, 082, 083, 084	Philco	003, 015, 017, 018, 048, 054, 059, 062, 069, 090	Zonda	001
Croslex	062	Philips	015, 017, 018, 040, 048, 054, 062, 072, 112, 114, 117, 118	Dongyang	003, 054
Crown	003	Pioneer	063, 066, 080, 091	LOWE	054
CURTIS MATHES	059, 061, 063	Portland	015, 018, 059	FINLUX	054, 109, 114
CXC	003	Proton	040	YOKO	054
Daewoo	002, 003, 004, 015, 016, 017, 018, 019, 020, 021, 022, 023, 024, 025, 026, 027, 028, 029, 030, 032, 034, 035, 036, 040, 048, 059, 090, 099, 100	QUASAR	006, 066, 067	LOEWE OPTA	054, 114
Daytron	040	Radio Shack	017, 048, 056, 060, 061, 075	PHONOLA	054, 112, 114
Dynasty	003	RCA/Proscan	018, 059, 067, 076, 077, 078, 092, 093, 094	RADIOLA	054, 112
Emerson	003, 015, 040, 046, 059, 061, 064, 082, 083, 084, 085	Realistic	003, 019	SCHNEIDER	054
Fisher	019, 065, 103	Sampo	040	AKAI	103
Funai	003	Samsung	000, 015, 016, 017, 040, 043, 046, 047, 048, 049, 054, 059, 060, 098	GRUNDIG	108, 109, 113, 119, 120, 121
Futuretech	003	Sanyo	019, 061, 065, 101, 102, 103, 104	BLAUPUNKT	108
General Electric (GE)	006, 040, 056, 059, 066, 067, 068	Scott	003, 040, 060, 061	SIEMENS	108
Hall Mark	040	Sears	015, 018, 019	CGE	113
Hitachi	015, 018, 050, 059, 069	Sharp	015, 057, 064, 101, 105, 106, 115	IMPERIAL	113
Inkel	045	Signature 2000 (M.Wards)	057, 058	MVAR	113
JC Penny	056, 059, 067, 086	Sony	050, 051, 052, 053, 055, 101	SABA	114
JVC	070	Soundesign	003, 040	BANG&OLUFSEN	114
KTV	059, 061, 087, 088	Spectricon	001	BRIONVEGA	114
KEC	003, 015, 040	SSS	018	FORMENTI	114
KMC	015			METZ	114
LG (Goldstar)	001, 015, 016, 017, 037, 038, 039, 040, 041, 042, 043, 044, 054, 086			WEGA	114
				RADIOMARELLI	114
				SINGER	114
				SINUDYNE	114
				TELEFUNKEN	116

# Miscellaneous

## OPERATING YOUR DVD OR BD PLAYER WITH THE REMOTE CONTROL

1. Press the **POWER** button to turn on the DVD (BD) player.
2. Press the **BD/DVD** button on the remote control to set the remote to DVD (BD) mode.
3. Point the remote control toward the DVD (BD).
4. While holding down **POWER** button, enter the code corresponding to your brand of DVD (BD).
  - If there is more than one code listed for your DVD (BD) in the table, enter one at a time to determine which code works.
  - If the code matches the DVD (BD)'s code, the DVD (BD) will be turned off.
5. If DVD (BD) is turned on or off when you press the **POWER** button of the remote controller, the setting is completed.
  - You can use DVD (BD) **POWER**, **PLAY**, **PAUSE**, **STOP**, **SKIP**, **MENU** and Numeric buttons (0~9).



- The remote control may not work on some brands of DVD. Also, some operations may not be possible depending on your brand of DVD.
- The remote control will work with Samsung DVD (BD) by default.

### DVD Brand Code List

Brand	Code Number	Brand	Code Number	Brand	Code Number
DENON	003, 032	ONKYO	004, 014	TOSHIBA	004, 018
DOONON	019	OPTIMUS	011	YAMAHA	009, 033
DMTECH	017	PANASONIC	021	ZENITH	004, 024
FISHER	002	PROSCAN	006	TAEGWANG	026
GE	006	PHILIPS	004, 023	PS2	028
HARMAN/KARDON	012	PIONEER	007, 011, 022, 025	X-BOX	029
JVC	010, 013	RCA	006	APEX	030
KENWOOD	008	SAMSUNG	000, 027	Marantz	031
LG	001	SANYO	002		
MAGNAVOX	004	SONY	015, 020		
MITSUBISHI	005, 016	THETA DIGITAL	011		

### BD player Brand Code List

Brand	Code Number
SAMSUNG	000, 001, 002, 003, 004



- The remote control will control Samsung BD players only.

# Troubleshooting

Before requesting service, please check the following.

Symptom	Check	Remedy
The unit will not turn on.	<ul style="list-style-type: none"> <li>Is the power cord plugged into the outlet?</li> </ul>	<ul style="list-style-type: none"> <li>Connect the power plug to the outlet.</li> </ul>
A function does not work when the button is pressed.	<ul style="list-style-type: none"> <li>Is there static electricity in the air?</li> </ul>	<ul style="list-style-type: none"> <li>Disconnect the power plug and connect it again.</li> </ul>
Sound is not produced.	<ul style="list-style-type: none"> <li>Are the speakers and external components connected properly?</li> <li>Is the Mute function on?</li> <li>Is the volume set to minimum?</li> <li>Is the Speaker Size set incorrectly to NONE?</li> </ul>	<ul style="list-style-type: none"> <li>Connect them correctly.</li> <li>Press the <b>MUTE</b> button to cancel the function.</li> <li>Adjust the volume.</li> <li>Refer to pages 34 to select LARGE, SMALL or YES.</li> </ul>
Picture does not appear on a TV when the function is selected.	<ul style="list-style-type: none"> <li>Is the external component connected properly?</li> </ul>	<ul style="list-style-type: none"> <li>Connect it correctly.</li> </ul>
Remote controller does not work.	<ul style="list-style-type: none"> <li>Are the batteries drained?</li> <li>Is the distance between remote control and main unit too great?</li> </ul>	<ul style="list-style-type: none"> <li>Replace with new batteries.</li> <li>Operate at close distance.</li> </ul>
The sound from the left/right channels is reversed.	<ul style="list-style-type: none"> <li>Are the left/right speaker or left/right input/output cables connected properly?</li> </ul>	<ul style="list-style-type: none"> <li>Check the left/right channel and connect it/them correctly.</li> </ul>
Can't receive radio broadcasts.	<ul style="list-style-type: none"> <li>Is FM antenna connected properly?</li> </ul>	<ul style="list-style-type: none"> <li>Connect the antenna correctly.</li> <li>If the input strength of antenna signal is weak, install the FM antenna in a place with good reception.</li> </ul>
There is no sound from surround speakers.	<ul style="list-style-type: none"> <li>Are the surround speakers connected properly?</li> <li>Is SURR (surround) incorrectly set to NONE in the Speaker Size?</li> <li>Is surround mode set to stereo?</li> </ul>	<ul style="list-style-type: none"> <li>Refer to pages 14 ~16 to connect them properly.</li> <li>Refer to page 34 to select LARGE or SMALL.</li> <li>Refer to pages 45~46 to select proper Surround Mode.</li> </ul>
There is no sound from surround back speakers	<ul style="list-style-type: none"> <li>Are the surround back speakers connected properly?</li> <li>Is SBACK (Surround Back) set to NONE in the Speaker Size?</li> <li>Is Surround Mode set to EX/ES?</li> </ul>	<ul style="list-style-type: none"> <li>Refer to pages 14 ~16 to connect them properly.</li> <li>Refer to page 34 to select LARGE or SMALL.</li> <li>Refer to page 41 to set Surround Mode to EX/ES.</li> </ul>
Can't select EX/ES mode.	<ul style="list-style-type: none"> <li>Is SBACK (Surround Back) set to NONE in the Speaker Size?</li> <li>Is the input signal selected properly?</li> </ul>	<ul style="list-style-type: none"> <li>Refer to page 34 to select LARGE or SMALL.</li> <li>Use a 7.1 channel external component.</li> </ul>

# Troubleshooting

Symptom	Check	Remedy
Can't select Dolby Pro Logic IIx mode.	<ul style="list-style-type: none"> <li>Is the input signal selected properly?</li> </ul>	<ul style="list-style-type: none"> <li>Only 2 channel signal can select Dolby Pro Logic IIx mode. (ex:Dolby Digital, PCM, 2 channel analog input signal.)</li> </ul>
Can't select NEO:6 mode.	<ul style="list-style-type: none"> <li>Is the input signal selected properly?</li> </ul>	<ul style="list-style-type: none"> <li>Use PCM and Analog input signal.</li> </ul>
There is no sound when playing a DTS encoded DVD.	<ul style="list-style-type: none"> <li>Is Digital input selected?</li> </ul>	<ul style="list-style-type: none"> <li>Check whether the DVD player is properly connected and refer to page 29 to select the digital input.</li> </ul>

## Product protection function

### Heat protection

- The protection function will come on if the main unit or power transformer overheats.

"PROTECTION" will appear in the display .

This function will come on :

- If speaker terminal is shorted
- If speaker cable is shorted

If there is no problem when you turn the unit on again after turning it off, PROTECTION mark will disappear on the display and the unit will work properly.



- If PROTECTION appears on the display, check whether the speaker terminal is shorted and then turn on the unit again.

## ASC Error List

Error No.	VFD Message	Action
E01	HP CONCT	Disconnect the headphones.
E02	NO MIC	Connect the microphone.
E03	NOISY	Take an appropriate action to reduce the surrounding noise.
E04	MIC LEVEL	The speaker is too close to the microphone. Check the distance between speaker and microphone.
E05	NO FRONT	Check if the front speaker is connected properly.
E07	LEVEL OVR	Check the position of each of speaker and microphone.
E08	DIST OVR	The distance between speaker and microphone exceeds the acceptable value. Check the location of microphone and each speaker.
E13	TIME OVR	Unplug the power cable and plug it back. Then, perform ASC again.
E14	CODE ERR	Unplug the power cable and plug it back. Then, perform ASC again.



## SPECIFICATIONS

GENERAL	Weight	13.7 lbs
	Dimensions (W x H x D)	17.2 x 6.6 x 14.7 inches
	Operating temperature range	41°F~+95°F
	Operating humidity range	10%~75%
FM TUNER	Frequency response	87.5~108.0MHz
	Usable sensitivity	12dBf
	S/N ratio	MONO/STEREO 55/55dB
	Distortion	MONO/STEREO 0.3/0.8%
	Stereo separation	30dB
	Tuner output level	1kHz, 75kHz Dev
AMPLIFIER	Rated output	20Hz~20kHz/THD = 0.9%
	Front speaker (left+right)	6 Ω 120W/CH
	Center speaker	6 Ω 120W/CH
	Surround speaker (left+right)	6 Ω 120W/CH
	Surround back speaker (left+right)	6 Ω 120W/CH
	Subwoofer speaker	8 Ω 150W/CH
	Input sensitivity/impedance	450mV/47kΩ
	S/N ratio (analog input)	80dB
	Separation (1kHz)	60dB
FREQUENCY RESPONSE	Analog input	20Hz~20kHz(±3dB)
	Digital input/96kHz PCM	20Hz ~44kHz(±3dB)
HDMI	Input	Compatible 1080p
	Output	Compatible 1080p
VIDEO OUTPUT	TV format	NTSC/PAL
	Input level/impedance	1Vp-p/75 Ω
	Output level/impedance	1Vp-p/75 Ω
	Video frequency response	5Hz to 10kHz(-3dB)
	S/N Ratio	60dB

\* S/N Ratio, Distortion, Separation and Usable sensitivity are based on measurement using AES (Audio Engineering Society) guidelines.

- Samsung Electronics Co., Ltd reserves the right to change the specifications without notice.
- Weight and dimensions are approximate.
- Design and specifications are subject to change without prior notice.
- For the power supply and Power Consumption, refer to the label attached to the product.



**SAMSUNG**

## LIMITED WARRANTY TO ORIGINAL PURCHASER

Samsung Electronics Canada Inc.(SECA), warrants that this product is free from defective material and workmanship.

SECA further warrants that if this product falls to operate properly within the specified warranty period and the failure is due to improper workmanship or defective materials, SECA will repair or replace the product at its option.

All warranty repairs must be performed by a SECA Authorized Service Center. (The name and address of the location nearest you can be obtained by calling toll free: 1- 800- SAMSUNG)

### LABOR

One year (Carry- in)

### PARTS

One year

On carry-in models, transportation to and from the service center is the customer's responsibility.

The original dated sales receipt must be retained by the customer and is the only acceptable proof of purchase. It must be presented to the authorized service center at the time service is requested.

## EXCLUSIONS (WHAT IS NOT COVERED)

This warranty does not cover damage due to accident, fire, flood and/ or other acts of God; misuse, incorrect line voltage, improper installation, improper or unauthorized repairs, commercial use or damage that occurs in shipping. Exterior and interior finish, lamps, glass are not covered under this warranty. Customer adjustments which are explained in the instruction manual are not covered under the terms of this warranty. This warranty will automatically be voided for any unit found with a missing or altered serial number. This warranty is valid only on products purchased and used in Canada.

**HEADQUARTERS  
SAMSUNG ELECTRONICS CANADA INC.,  
CUSTOMER SERVICE  
55 STANDISH COURT MISSISSAUGA, ONTARIO L5R 4B2 CANADA  
FABRIQUE EN CORÉE  
1-800-SAMSUNG (1-800-7267864)  
WWW.SAMSUNG.COM/CA**

## Contact SAMSUNG WORLD WIDE

If you have any questions or comments relating to Samsung products, please contact the SAMSUNG customer care center.

Area	Contact Center ☎	Web Site
<b>■ North America</b>		
Canada	1-800-SAMSUNG (726-7864)	www.samsung.com
Mexico	01-800-SAMSUNG (726-7864)	www.samsung.com
U.S.A	1-800-SAMSUNG (726-7864)	www.samsung.com
<b>■ Latin America</b>		
Argentina	0800-333-3733	www.samsung.com
Brazil	0800-124-421 4004-0000	www.samsung.com
Chile	800-SAMSUNG (726-7864)	www.samsung.com
Nicaragua	00-1800-5077267	www.samsung.com
Honduras	800-7919267	www.samsung.com
Costa Rica	0-800-507-7267	www.samsung.com
Ecuador	1-800-10-7267	www.samsung.com
El Salvador	800-6225	www.samsung.com
Guatemala	1-800-299-0013	www.samsung.com
Jamaica	1-800-234-7267	www.samsung.com
Panama	800-7267	www.samsung.com
Puerto Rico	1-800-682-3180	www.samsung.com
Rep. Dominica	1-800-751-2676	www.samsung.com
Trinidad & Tobago	1-800-SAMSUNG (726-7864)	www.samsung.com
Venezuela	0-800-100-5303	www.samsung.com
Colombia	01-8000112112	www.samsung.com
<b>■ Europe</b>		
Austria	0810 - SAMSUNG (7267864, € 0.07/min)	www.samsung.com
Belgium	02-201-24-18	www.samsung.com/ be (Dutch) www.samsung.com/ be_fr (French)
Czech	800 - SAMSUNG (800-726786)	www.samsung.com
Denmark	70 70 19 70	www.samsung.com
Finland	030 - 6227 515	www.samsung.com
France	01 48 63 00 00	www.samsung.com
Germany	01805 - SAMSUNG (726-7864 € 0,14/Min)	www.samsung.com
Hungary	06-80-SAMSUNG (726-7864)	www.samsung.com
Italia	800-SAMSUNG (726-7864)	www.samsung.com
Luxemburg	261 03 710	www.samsung.com
Netherlands	0900-SAMSUNG (0900-7267864) (€ 0,10/Min)	www.samsung.com
Norway	815-56 480	www.samsung.com
Poland	0 801 1SAMSUNG (172678) 022-607-93-33	www.samsung.com
Portugal	80820-SAMSUNG (726-7864)	www.samsung.com
Slovakia	0800-SAMSUNG (726-7864)	www.samsung.com
Spain	902 - 1 - SAMSUNG (902 172 678)	www.samsung.com
Sweden	0771 726 7864 (SAMSUNG)	www.samsung.com
U.K	0845 SAMSUNG (7267864)	www.samsung.com
Eire	0818 717100	www.samsung.com

Area	Contact Center ☎	Web Site
Switzerland	0848 - SAMSUNG (7267864, CHF 0.08/min)	www.samsung.com/ch www.samsung.com/ ch_fr/ (French)
Lithuania	8-800-77777	www.samsung.com
Latvia	8000-7267	www.samsung.com
Estonia	800-7267	www.samsung.com
<b>■ CIS</b>		
Russia	8-800-555-55-55	www.samsung.com
Georgia	8-800-555-555	
Armenia	0-800-05-555	
Azerbaijan	088-55-55-555	
Kazakhstan	8-10-800-500-55-500	
Uzbekistan	8-10-800-500-55-500	www.samsung.com
Kyrgyzstan	00-800-500-55-500	www.samsung.com
Tadjikistan	8-10-800-500-55-500	www.samsung.com
Ukraine	0-800-502-000	www.samsung.ua www.samsung.com/ ua_ru
Belarus	810-800-500-55-500	
Moldova	00-800-500-55-500	
<b>■ Asia Pacific</b>		
Australia	1300 362 603	www.samsung.com
New Zealand	0800 SAMSUNG (0800 726 786)	www.samsung.com
China	400-810-5858 010-6475 1880	www.samsung.com
Hong Kong	(852) 3698-4698	www.samsung.com/ hk www.samsung.com/ hk_en/
India	3030 8282 1800 110011 1800 3000 8282 1800 266 8282	www.samsung.com
Indonesia	0800-112-8888 021-5699-7777	www.samsung.com
Japan	0120-327-527	www.samsung.com
Malaysia	1800-88-9999	www.samsung.com
Philippines	1-800-10-SAMSUNG (726-7864) 1-800-3-SAMSUNG (726-7864) 1-800-8-SAMSUNG (726-7864) 02-5805777	www.samsung.com
Singapore	1800-SAMSUNG (726-7864)	www.samsung.com
Thailand	1800-29-3232 02-689-3232	www.samsung.com
Taiwan	0800-329-999	www.samsung.com
Vietnam	1 800 588 889	www.samsung.com
<b>■ Middle East &amp; Africa</b>		
Turkey	444 77 11	www.samsung.com
South Africa	0860-SAMSUNG (726-7864)	www.samsung.com
U.A.E	800-SAMSUNG (726-7864)	www.samsung.com
Bahrain	8000-4726	
Jordan	800-22273	



Code No. AH68-02260S