



## Controls & Definitions

---

**TO PREVENT FIRE OR SHOCK HAZARDS, DO NOT EXPOSE THIS UNIT TO RAIN OR MOISTURE.**



This symbol, located on back or bottom of the unit, is intended to alert the user to the presence of uninsulated “dangerous voltage” within the product’s enclosure that may be of sufficient magnitude to constitute a risk of electric shock to persons.



This symbol, located on back or bottom of the unit, is intended to alert the user to the presence of important operating and maintenance (servicing) instructions in the literature accompanying the appliance.



This product utilizes a Class 1 laser to read Compact Discs. This laser Compact Disc Player is equipped with safety switches to avoid exposure when the CD door is open and the safety interlocks are defeated. Invisible laser radiation is present when the CD Player’s lid is open and the system’s interlock has failed or been defeated. It is very important that you avoid direct exposure to the laser beam at all times. Please do not attempt to defeat or bypass the safety switches.

**CAUTION: TO PREVENT ELECTRIC SHOCK, MATCH WIDE BLADE OF PLUG TO WIDE SLOT, FULLY INSERT.**

To reduce the risk of electric shock, do not remove cover (or back). There are no user-serviceable parts inside. Please refer any servicing to qualified service personnel.

**WARNING:** Changes or modifications to this unit not expressly approved by the party responsible for compliance could void the user’s authority to operate the equipment.

**WARNING:** Danger of explosion if the remote control’s batteries are incorrectly installed. Replace only with the same or equivalent battery.

**WARNING:** The remote control’s button cell battery contains mercury. Do not put in the trash, instead recycle or dispose of as hazardous waste

**WARNING:** Use of this unit near fluorescent lighting may cause interference regarding use of the remote. If the unit is displaying erratic behavior move away from any fluorescent lighting, as it may be the cause.

**NOTE:** This equipment has been tested and found to comply with the limits for a Class B digital device, pursuant to Part 15 of the FCC Rules. These limits are designed to provide reasonable protection against harmful interference in a residential installation. This equipment generates, uses, and can radiate radio frequency energy and, if not installed and used in accordance with the instructions, may cause harmful interference to radio communications. However, there is no guarantee that interference will not occur in a particular installation. If this equipment does cause harmful interference to radio or television reception, which can be determined by turning the equipment off and on, the user is encouraged to try to correct the interference by one or more of the following measures:

- Reorient or relocate the receiving antenna.
- Increase the separation between the equipment and receiver.
- Connect the equipment into an outlet on a circuit different from that to which the receiver is connected.
- Consult the dealer or an experienced radio/TV technician for help.

**1. Read these instructions.** All the safety and operating instruction should be read before the product is operated.

**2. Keep these instructions.** The safety and operating instruction should be retained for future reference.

**3. Heed all warnings.** All warning on the product and in the operating instructions should be adhered to.

**4. Follow all instructions.** All operating and use instructions should be followed.

**5. Water and Moisture:** Do not use this product near water - for example, near a bath tub, wash bowl, kitchen sink, or laundry tub; in a wet basement, or near a swimming pool, and the like. The apparatus shall not be exposed to dripping or splashing and that no objects filled with liquids, such as vases, shall be placed on apparatus.

**6. Cleaning:** Clean only with a dry cloth. Unplug this product from the wall outlet before cleaning. Do not use liquid cleaners or aerosol cleaners.

**7. Ventilation:** Slots and openings in the cabinet are provided for ventilation and to ensure reliable operation of the product and to protect it from overheating, and these openings must not be blocked or covered. The openings should never be blocked by placing the product on a bed, sofa, rug, or other similar surface. This product should not be placed in a built-in installation such as a bookcase or rack unless proper ventilation is provided or the manufacturer's instructions have been adhered to.

**8. Heat:** Do not install near any heat sources such as radiators, heat registers, stoves, or other apparatus (including amplifiers) that produce heat.

**9. Grounding or Polarization:** Do not defeat the safety purpose of the polarized or grounding-type plug. A polarized plug has two blades with one wider than the other. A grounding type plug has two blades and a third grounding prong. The wide blade or the third prong are provided for your safety. If the provided plug does not fit into your outlet, consult an electrician for replacement of the obsolete outlet.

**10. Power-Cord Protection:** Protect the power cord from being walked on or pinched particularly at plugs, convenience receptacles, and the point where they exit from the apparatus.

**11. Accessories:** Only use attachments/accessories specified by the manufacturer. Do not place this product on an unstable cart, stand tripod, bracket, or table. The

product may fall, causing serious injury to a child or adult, and serious damage to the product. Use only with a cart, stand, tripod, bracket, or table recommended by the manufacturer, or sold with the product. Any mounting of the product should follow the manufacturer's instructions, and should use a mounting accessory recommended by the manufacturer.

**12.** A product and cart combination should be moved with care. Use only with the cart, stand, tripod, bracket, or table specified by the manufacturer, or sold with the apparatus. When a cart is used, use caution when moving the cart/apparatus combination to avoid injury from tip-over.



**13. Lightning:** Unplug this apparatus and disconnect the antenna or cable system during lightning storms or when unused for long periods of time. This will prevent damage to the product due to lightning and power-line surges.

**14. Servicing:** Do not attempt to service this product yourself as opening or removing covers may expose you to dangerous voltage or other hazards. Refer all servicing to qualified service personnel.

**15. Power Sources:** Only connect to the type of house-hold power supply as indicated in the operating instructions and rating label. If you are not sure of the type of power supply to your home, consult your product dealer or local power company. For products intended to operate from battery power, or other sources, refer to the operating instruction.

**16. Overloading:** Do not overload wall outlets or extension cords as this can result in a risk of fire or electric shock.

**17. Object and Liquid Entry:** Never push objects of any kind or spill liquid into this product through openings as this could result in a risk of fire or electric shock.

**18. Replacement Parts and Safety Check:** When replacement parts are required, be sure the service technician has used replacement parts specified by the manufacturer. Ask the service technician to perform safety checks to ensure proper operation to avoid possible fire, electric shock, or other hazards.

**19. Outdoor Antenna Grounding:** If an outside antenna or cable system is connected to the product, be sure the antenna or cable system is grounded so as to provide some protection against voltage surges and built-up static charges. Article 810 of the National Electrical Code, ANSI/NFPA 70, provides information with regard to proper grounding of the mast and supporting structure, grounding of the lead-in wire to an antenna connection to grounding electrodes, and requirements for the grounding electrode.

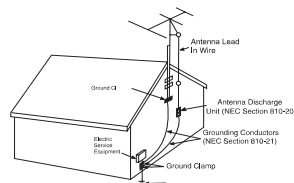

**20. Wall or Ceiling Mounting:** The product should be mounted to a wall or ceiling only as recommended by the manufacturer.

**21.** Where the AC plug is used as the disconnect device, the disconnect device shall remain readily operable.

**22. Protective Attachment Plug:** The product is equipped with an attachment plug having overload protection. This is a safety feature. See Instruction Manual for replacement or resetting of protective device. If replacement of the plug is required, be sure the service technician has used a replacement plug specified by the manufacturer that has the same overload protection as the original plug.

**23. Power Lines:** An outside antenna system should not be located in the vicinity of overhead power lines or other electric light or power circuits, or where it can fall into such power lines or circuits. When installing an outside antenna system, extreme care should be taken to keep from touching such power lines or circuits as contact with them might be fatal.

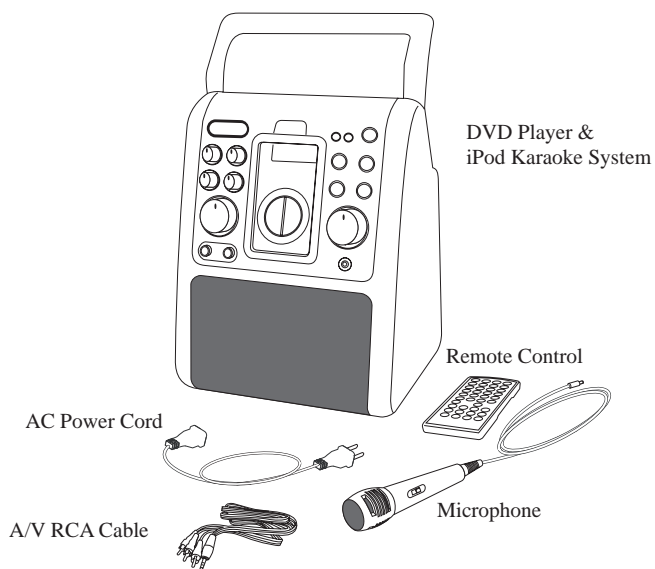

- DVD Player & iPod Karaoke System
- Microphone
- Remote Control
- A/V RCA Cable
- AC Power Cord
- Documentation

- 
- |  |                            |
|--|----------------------------|
| • Plays DVD, CD, and CD+G discs  | • Video Output             |
| • Compatible with iPod photo, iPod with color display, iPod with video, iPod mini, and iPod nano | • Two Microphone Inputs    |
| • Auxiliary Input  | • AC Powered               |
| • Auxiliary Output   | • Carry Handle             |
|  | • Blue-Backlit LCD Display |
-

- 
1. To power the unit, simply connect it to an AC outlet using the attached AC cord.
  2. Press the **Power Button** to turn the unit on.

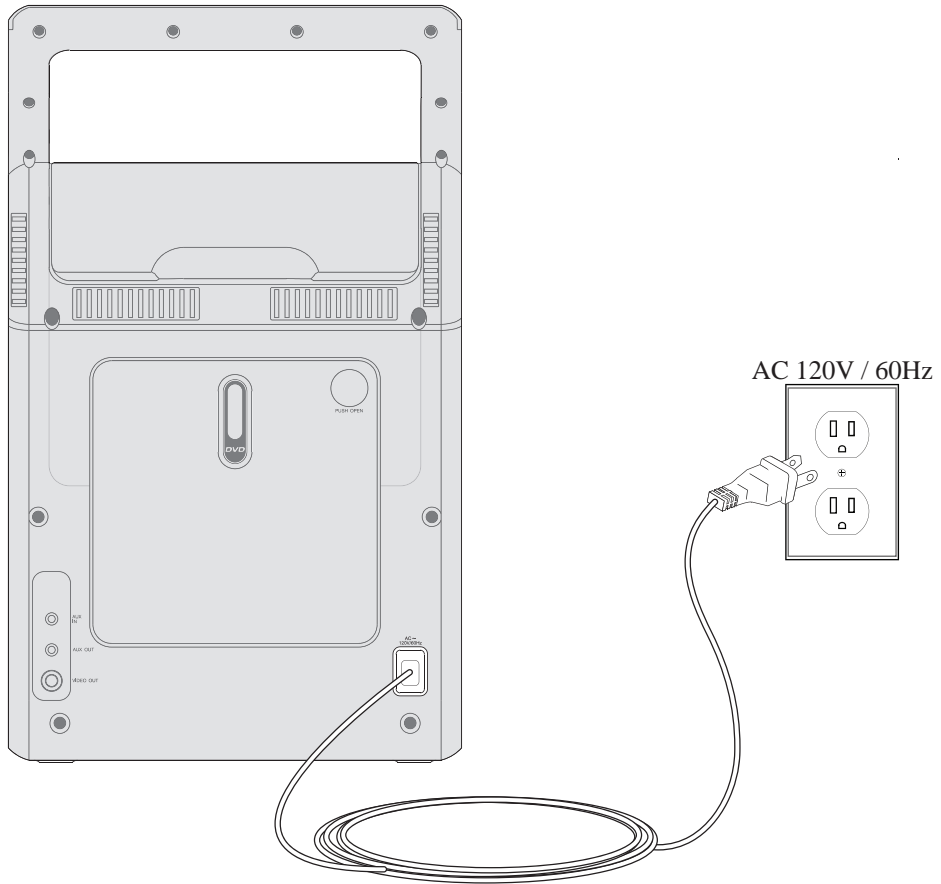

1. Turn the **Dock Adjustment Dial** to the appropriate iPod model or memory size.

*iPod models and memory sizes that are not listed on the **Dock Adjustment Dial** can be docked by manually adjusted to the depth that fits the iPod best.*

2. Open the **Docking Station** using the lip located at the top of the **Docking Station**.
3. When inserting an iPod nano, slide the Dock connector on the unit so that it matches the connection on the iPod nano.
4. Connect the iPod to the **Dock Connector**.
5. Close the **Docking Station**.

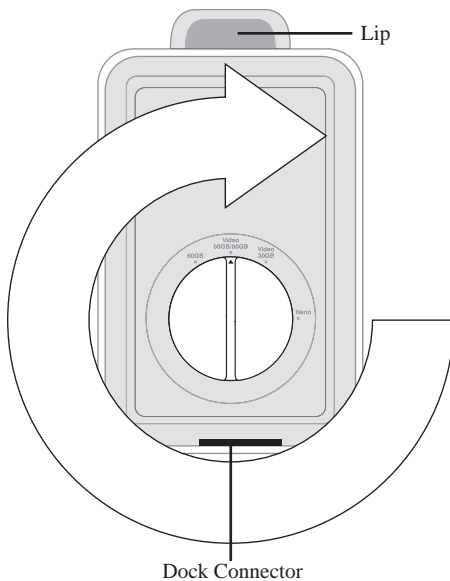

## iPod Compatibility



**iPod mini**  
1st generation  
4GB 6GB



**iPod**  
4th generation  
20GB



**iPod**  
4th generation  
40GB



**iPod**  
4th generation (color display)  
20GB 30GB



**iPod**  
4th generation (color display)  
40GB 60GB



**iPod nano**  
1st generation  
1GB 2GB 4GB



**iPod**  
5th generation (video)  
30GB



**iPod**  
5th generation (video)  
60GB 80GB



**iPod nano**  
2nd generation  
2GB 4GB 8GB

1. Dock an iPod into the **Docking Station**. See “Docking an iPod” on page 6.
2. Press the **Power Button** to turn the unit on.
3. Adjust the **AUX/DVD/CDG/iPod Dial** to **iPod**.
4. Press the **Play/Pause Button** to play or pause the iPod.
5. Press the **Skip/Search Buttons** to skip from one track to the next or to previous tracks. Press and hold the **Skip/Search Buttons** to scan through an individual track.
6. Before singing along with an iPod, plug in the microphone and turn the **Microphone On/Off Switch** to the **On** position.

*If feedback noise is present, move the microphone away from the unit and/or reduce the microphone's volume.*

7. Adjust the **Volume Dial** to set the volume of the speakers. Adjust the **Microphone Volume Dial** to set the volume of a plugged in microphone.
8. Turn the **Echo Dial** to adjust the echo effect added to the audio from the microphone.
9. Plug headphones (not included) into the **Headphone Output** to disable the stereo speakers, and listen to an iPod in private.

10. Turn the **Music/Karaoke Dial** to **Music**. Use the **AVC Dial** to adjust the balance between the music and vocals. In *Music Mode* the iPod audio track's vocals can not be cut out completely even if the **AVC Dial** is set to max.
11. Turn the **Music/Karaoke Dial** to **Karaoke**. Use the **AVC Dial** to adjust the balance between the music and vocals. In *Karaoke Mode* the iPod Karaoke track's vocals can be cut out completely, the same as playing CD-G.

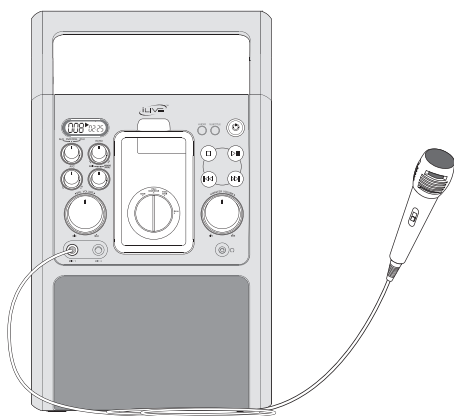

1. Press the **Power Button** to turn the unit on.
2. Load the CD+G Disc into the unit using the **CD Door** on the back of the unit.
3. Adjust the **AUX/DVD/CDG/iPod Dial** to **CDG**.
4. Press the **Play/Pause Button** to play and pause the loaded disc. Press the **Stop Button** to stop the disc.
5. Press the **Skip/Search Buttons** to skip from one track to the next or to previous tracks.

*The Search functionality will not work with a CD+G disc.*

6. Before singing along with a CD+G disc, plug in the microphone and turn the **Microphone On/Off Switch** to the **On** position.

*If feedback noise is present, move the microphone away from the unit and/or reduce the microphone's volume.*

7. Adjust the **Volume Dial** to set the volume of the speakers. Adjust the **Microphone Volume Dial** to set the volume of a plugged in microphone.
8. Use the **AVC Dial** to adjust the balance between the music and the recorded vocal volume when singing into the microphone.
9. When singing with a CD+G karaoke disc, turn the **Music/Karaoke Dial** to **Karaoke**.
10. Press the **Repeat Button** on the remote once to repeat an individual song. Press the **Repeat Button** on the remote twice to repeat an entire album.
11. Turn the **Echo Dial** to adjust the echo effect added to the audio from the microphone.
12. Plug headphones (not included) into the **Headphone Output** to disable the stereo speakers, and listen to the CD+G in private.

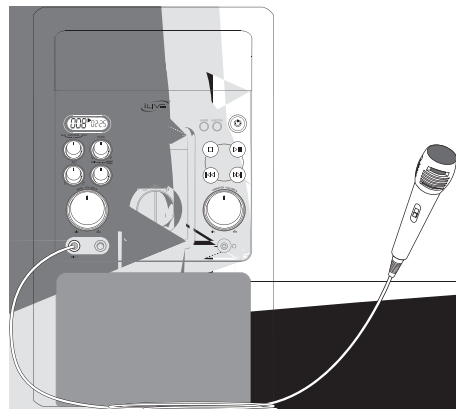
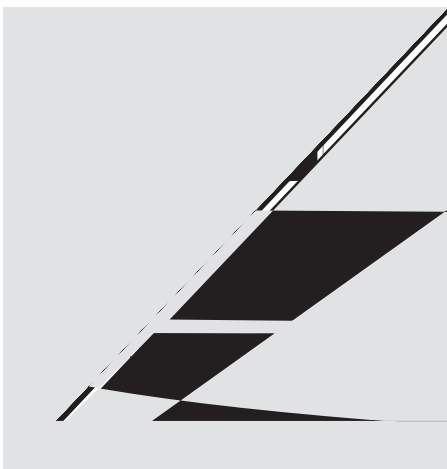





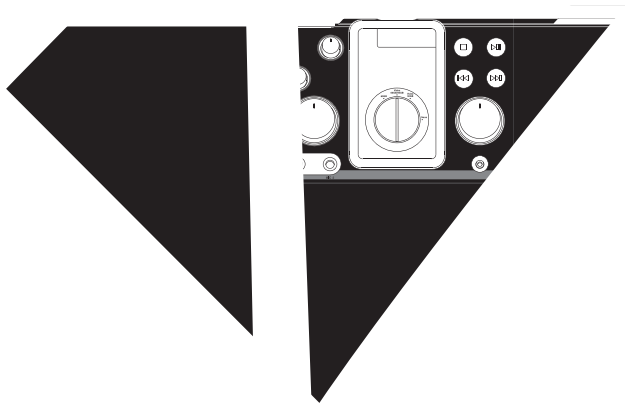

---

*When connecting two products using an RCA Cable, match the colored ports with the same colored connection. (Red to Red, White to White, and Yellow to Yellow)*

1. Plug one end of the RCA Cable (included) into the **Video Output** on the unit.
  2. Plug the other end of the RCA Cable into a video input on a television.
  3. Set the television to the appropriate video input.
  4. Press the **Power Button** to turn the unit on.
  5. Insert a DVD, CD+G disc, or iPod with video into the unit.
  6. Adjust the **AUX/DVD/CDG/iPod Dial** to **DVD**, **CDG**, or **iPod** to match the appropriate function.
  7. If an iPod with video was connected, on the iPod, navigate to either the Photos or Videos. Select either Slideshow Settings in Photos or Video Settings in Videos. Set the TV Out setting to On.
  8. Press the **Play/Pause Button**. The connected television will now display lyrics from the loaded CD+G disc or video and photos from the docked iPod with video.
- 

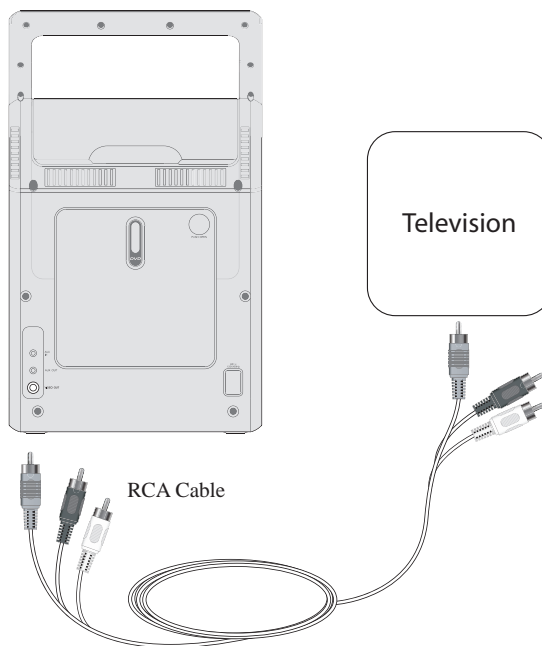

---

*When connecting two products using an RCA Cable, match the colored ports with the same colored connection. (Red to Red, White to White, and Yellow to Yellow)*

1. Plug one end of a 3.5 mm Cable (not included) or a 3.5 mm to RCA Cable (not included) into the **AUX Output** on the unit.
2. Plug the other end of the 3.5 mm Cable into the audio input/line input on a television or stereo system.
3. Set the television or stereo system to the appropriate audio input channel.
4. Press the **Power Button** to turn the unit on.
5. Audio played from the unit will now be heard on the connected television or stereo system.

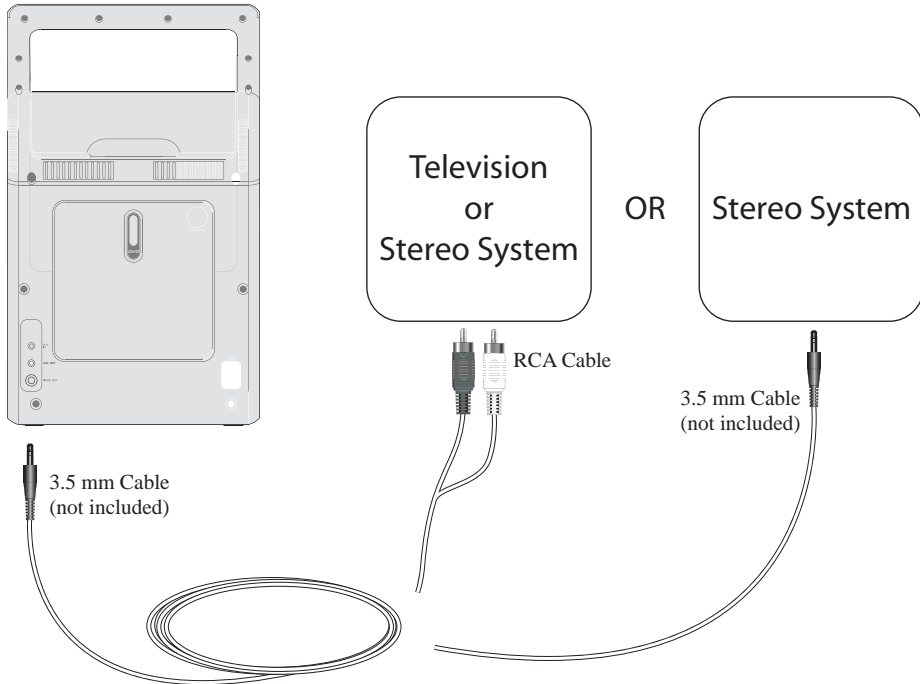

---

*When connecting two products using an RCA Cable, match the colored ports with the same colored connection. (Red to Red, White to White, and Yellow to Yellow)*

1. Plug one end of a 3.5 mm Cable (not included) or a 3.5 mm - RCA Cable (not included) into the **AUX Input** on the unit.
2. Plug the other end of the 3.5 mm Cable into the audio output/headphone output on an Mp3 Player or Other Audio Source.
3. Press the **Power Button** to turn the unit on.
4. Adjust the **AUX/DVD/CDG/iPod Dial** to **AUX**.
5. Audio played from the Mp3 Player or Other Audio Source will now be heard on the unit.

*If connecting to the headphone output of an audio source, the source's volume controls may need to be adjusted for optimal sound.*

---

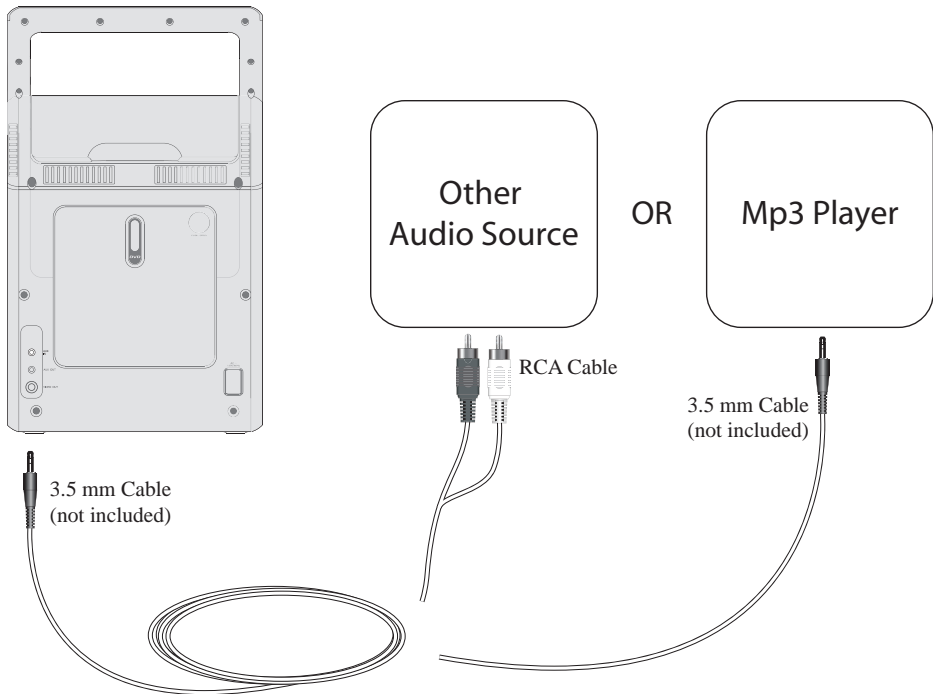

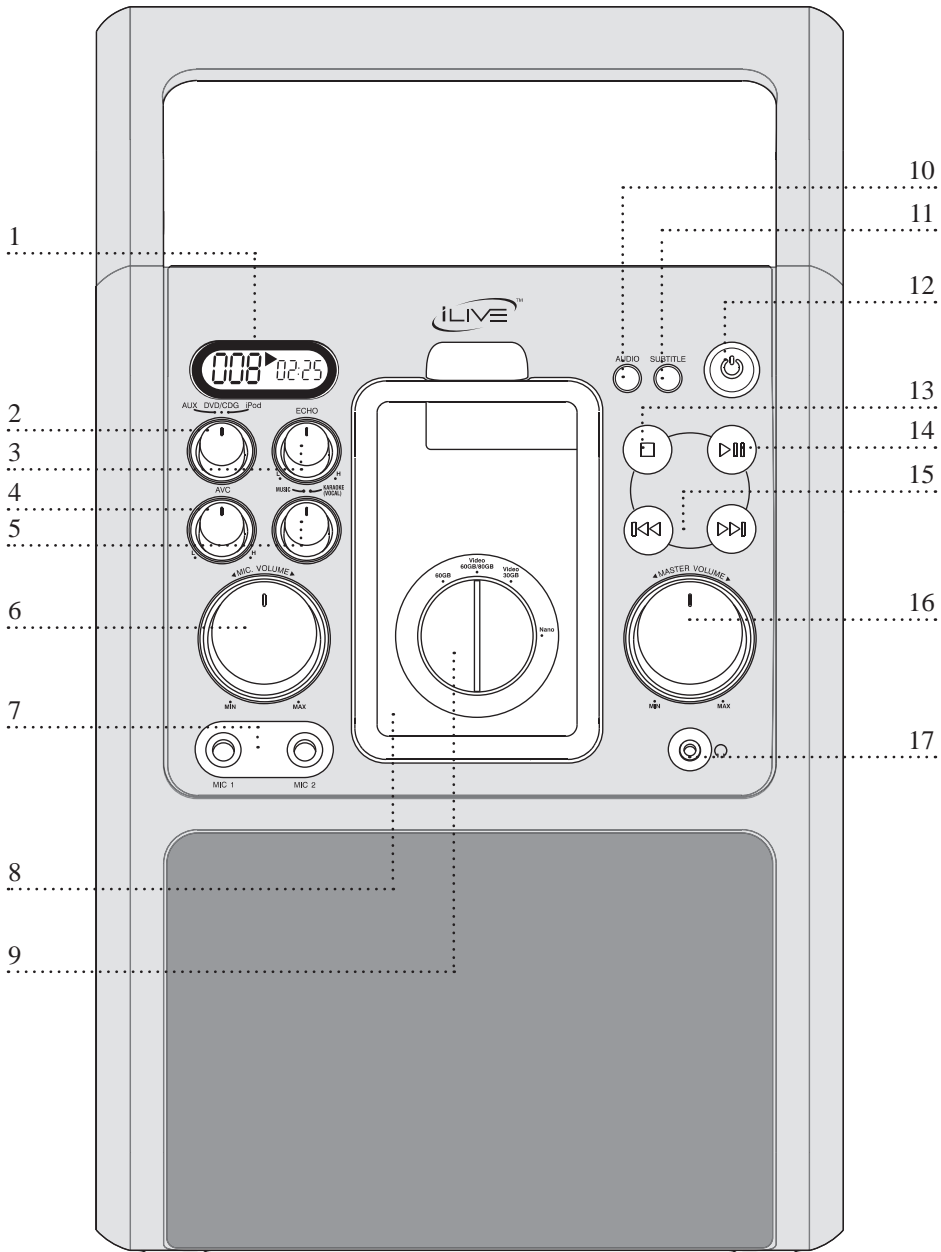

## Control Definitions: Front View

---

- 1 Blue Backlit LCD Display**  
The LCD Display shows CD and CD+G track numbers.

---

- 2 AUX/DVD/CDG/iPod Dial**  
Turn the AUX/DVD/CDG/iPod Dial to switch between AUX (auxiliary), DVD, CD/CD+G, and iPod Mode.

---

- 3 Echo Dial**  
Turn the Echo Dial to add an echo effect to the microphone inputs.

---

- 4 AVC Dial (Automatic Voice Control)**  
Use the AVC Dial to adjust the balance between the music and the recorded vocal volume when singing into the microphone.

---

- 5 Music/Karaoke Dial**  
Switch the Music/Karaoke Dial to Music when singing along with a standard audio CD or basic iPod audio track. Switch the Music/Karaoke Dial to Karaoke when singing along with a CD+G karaoke disc or karaoke iPod audio tracks.

---

- 6 Mic (Microphone) Volume Dial**  
Turn the Mic Volume Dial to adjust the volume of the Microphone Inputs.

---

- 7 Mic 1 & 2 Inputs**  
Use the Mic 1 & 2 Inputs as receptacles for a microphone plug.

---

- 8 Docking Station**  
Use the Dock as a connection for an iPod.

---

- 9 Dock Adjustment Dial**  
Turn the Dock Adjustment Dial to adjust the Dock for a specific sized iPod.

---

- 10 Audio**  
Press the Audio Button to adjust the DVD's audio language.

---

- 11 Subtitle**  
Press the Subtitle Button to turn the subtitles on or off, and to adjust between different subtitle languages.

---

- 12 Power Button**  
Press the Power Button to turn the unit off or on.

---

- 13 Stop Button**  
Press the Stop Button to stop a CD or CD+G during play.

---

- 14 Play/Pause Button**  
Press the Play/Pause Button to play and pause a CD+G, CD or docked iPod.

---

- 15 Skip/Search Buttons**  
Press the Skip/Search Buttons to skip from one track to the next or previous track. Press and hold the Skip/Search Buttons to search through an individual track (not available for CD+G discs).

---

- 16 Master Volume Dial**  
Turn the Master Volume Dial to increase or decrease the volume of audio that is output from the unit.

---

- 17 Headphone Output**  
Use the Headphone Output to connect headphones and listen to audio from the unit in private.

---

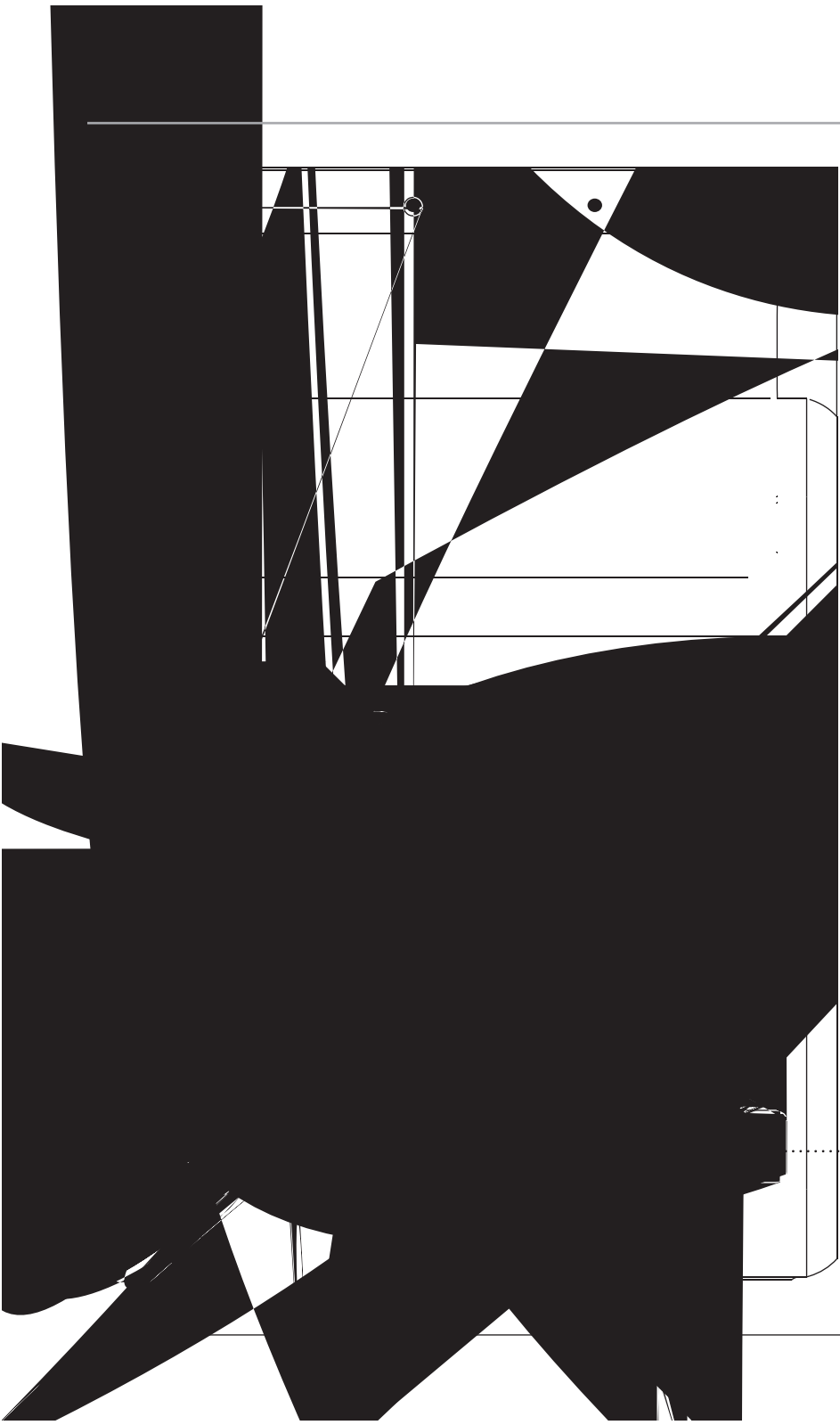



## Control Definitions: Back View

---

### **18 Carry Handle**

Use the carry handle to transport the unit.

---

### **19 CD Door**

The CD Door opens to expose the CD Compartment.

---

### **20 AUX Input (*Auxiliary*)**

Connect the AUX Input to an Mp3 Player or Other Audio Source to play audio from the Mp3 Player or Other Audio Source on the unit. See “AUX Input: to an Mp3 Player or Other Audio Source” on page 13.

---

### **21 AUX Output (*Requires a 3.5mm cable, not included*)**

Connect the AUX Output to a television or stereo system to play audio from the unit, on a television or stereo system. See “Audio Output: to a Television or Stereo System” on page 12.

---

### **22 Video Output**

Use the Video Output to play video from a docked iPod on a connected TV. See “Video Output: Connecting a Television” on page 11.

---

### **23 AC Power Input**

Plug the detachable AC Power Cord into the AC Power Input and an AC Outlet to power the unit.

---

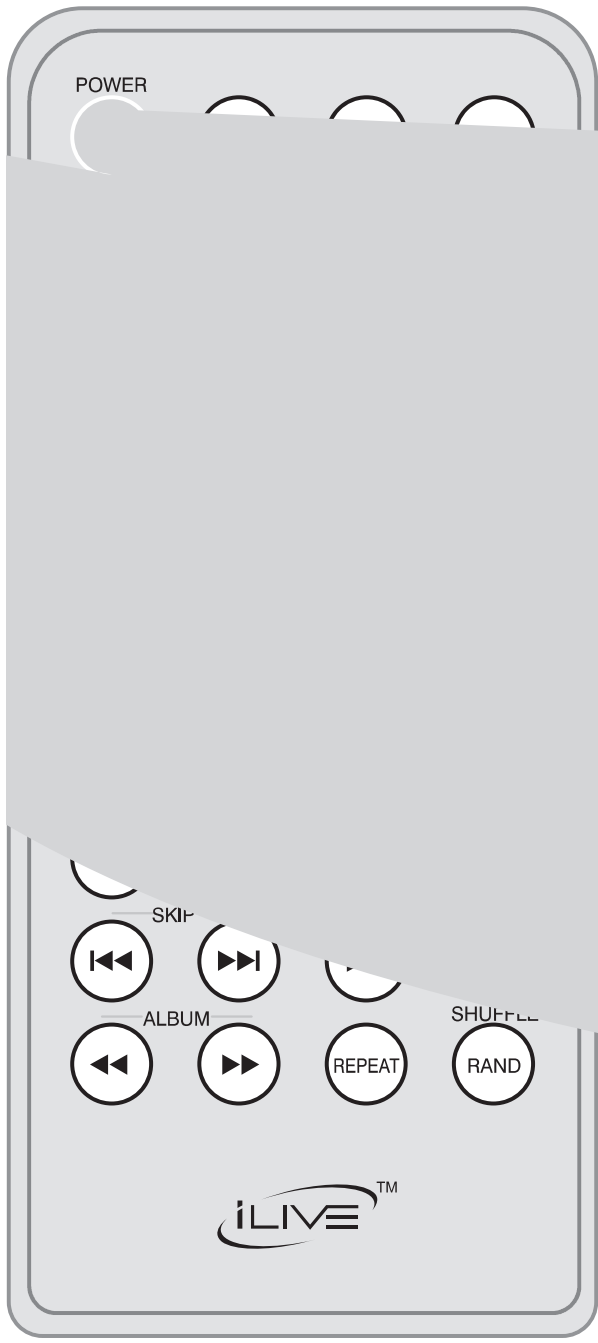

POWER

SKIP



ALBUM



SHUFFLE

REPEAT

RAND



## Control Definitions: Remote Control

---

- 24 Power Button**  
Press the Power Button to turn the unit off and on.
- 
- 25 Zoom Button**  
Press the Zoom Button to zoom in and out while playing a DVD.
- 
- 26 Number Keypad**  
Use the Number Keypad to enter track, title, and chapter numbers when programming a CD or DVD.
- 
- 27 Playlist - Button**  
Press the Playlist - Button to navigate through iPod and DVD menus, or to cycle down through playlists on an iPod.
- 
- 28 Chapter Button**  
In iPod Mode, press the Chapter Buttons to cycle through movie chapters from an iPod.
- 
- 29 Wide Button**  
Press the Wide Button to switch the Aspect Ratio between 4:3 Pan Scan, 4:3 Letter Box, or Wide.
- *The WIDE button will only work when the unit is in play mode.*
- 
- 30 GoTo Button**  
Press the GOTO Button to quickly switch between DVD chapters, or enter a time and instantly go to the selected time of a DVD.
- 
- 31 Skip Buttons**  
Press the Skip Buttons to skip through tracks or chapters.
- 
- 32 Album Buttons**  
In iPod Mode, press the Album Buttons to cycle through albums from an iPod.
- 
- 33 Repeat Button**  
Press the Repeat Button once to repeat an individual song or an entire album.
- 
- 34 Subtitle Button**  
Press the Subtitle Button to turn the subtitles on or off, and to adjust between different subtitle languages.
- 
- 35 Audio Button**  
Press the Audio Button to adjust the DVD's audio language.
- 
- 36 Angle Button**  
The Angle Button works with compatible DVDs to adjust to alternate angles while watching.
- 
- 37 Title Button**  
Press the Title Button to see the Title Menu on a DVD.
- 
- 38 Setup Button**  
Press the Setup Button to display the DVD Player's setup menu.
- 
- 39 Menu Button**  
Press the Menu Button to navigate through iPod and DVD menus.
- 
- 40 Menu Button**  
Press the Menu Button to see the menu of the DVD disc in the player. In iPod Mode, the Menu Button works exactly like the menu button on the iPod.
- 
- 41 Enter Button**  
Press the Enter Button to make selections in the iPod or DVD menus.
-

## Control Definitions: Remote Control

---

### **42 Playlist + Button**

Press the Playlist + Button to navigate through iPod and DVD menus, or to cycle up through playlists on an iPod.

---

### **43 Menu Button**

Press the Menu Button to navigate through iPod and DVD menus.

---

### **44 Slow Button**

Press the Slow Button to activate and deactivate the Slow Motion feature while playing a DVD.

---

### **45 OSD Button**

Press the OSD (On Screen Display) Button to show the Time, Title, Chapter, Audio Language, Subtitle Setting, and Angle settings of a DVD.

---

### **46 Play/Pause Button**

Press the Play/Pause Button to play or pause a CD, CD+G, DVD or an iPod.

---

### **47 Stop Button**

Press the Stop Button to stop a CD, CD+G, or DVD.

---

### **48 RAND (Random)/Shuffle Button**

Press the RAND/Shuffle Button to shuffle songs played from an iPod, or play tracks randomly from a CD.

---



## Language

Use the Language Section of the Setup Menu to change the language of the DVD Player's interfaces as well as the DVD subtitles, audio, and menu. Subtitle, Audio and DVD Menu Languages are dependent on the DVD content.

**OSD** In the OSD (On Screen Display) Section choose from English, Spanish, French, German and Italian as different OSD Languages

**Disc** Use the Disc setting to select the written language on the DVD's main menu. The DVD Menu setting is dependent on the DVD content.

**Audio** Use the Audio setting to select the audio language of the DVD. The Audio setting is dependent on the DVD's language offerings.

**Subtitle** The Subtitle setting allows the user to turn subtitles on and change the language of the subtitles. The Subtitle setting is dependent on the DVD's language offerings.

**Version** The latest version of firmware will be displayed.

**Reset** The Defaults Settings button will change all settings back to the original factory defaults.

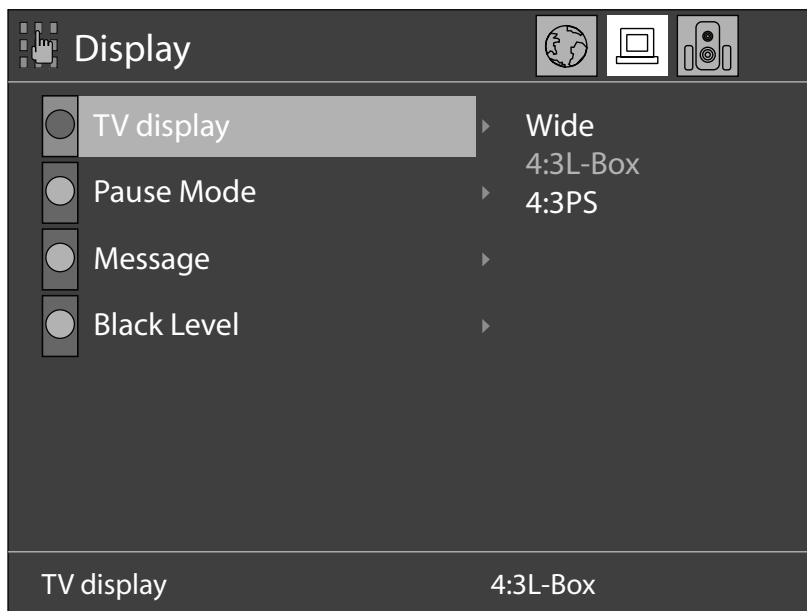

## Display

**TV Display** The ratio of the width of an image to its height.

- **4:3PS** The 4:3PS (Pan & Scan) ratio shows the DVD movie in standard 4:3 aspect ratio screen, but the sides of the movie are cut away so that it fits on a standard TV screen
- **4:3L-Box** The 4:3L-Box (Letterbox) ratio shows the DVD movie in a original format.
- **Wide (16:9)** The Wide ratio shows the DVD movie in its widescreen format. Use this setting when viewing a movie on a widescreen TV.

### Pause Mode

- **Auto** When Auto is selected, the Field/Frame will automatically be converted.
- **Field** Select Field to pause any field of view in the movie. The picture will have less definition when paused in Field Mode.
- **Frame** Select Frame to pause a frame of a movie. The picture will have more definition when paused in Frame Mode.

**Message** Turn the message on to receive on-screen messages indicating the current function.

**Black Level** Turn the Black Level on to increase the level of black in a DVD movie.

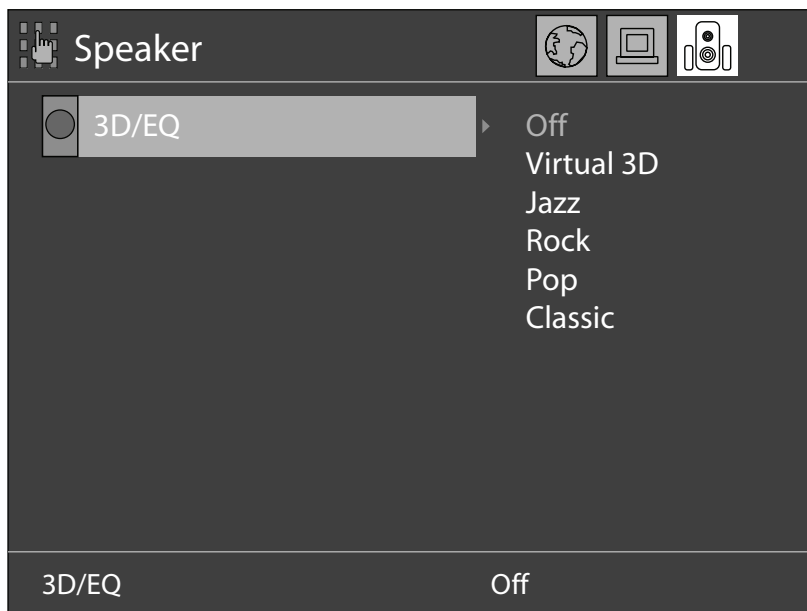

## Audio

**3D/EQ** Choose between Virtual 3D, Jazz, Rock, Pop, and Classic equalizer settings to hone the audio output to a specific type of music.



## Service Information

**Address** 2116 Carr Street, St. Louis MO, 63106

**Phone** 1-314-621-2881

**Fax** 1-314-588-1805

**Email** [customerservice@ilive.net](mailto:customerservice@ilive.net)

**Website** [www.ilive.net](http://www.ilive.net)

---

To download this Instruction Manual in English, Spanish, or French visit the Support section at [www.ilive.net](http://www.ilive.net).

Para descargar este manual de instrucción en inglés, español, o francés visite la sección de la ayuda en [www.ilive.net](http://www.ilive.net).

Pour télécharger ce manuel d'instruction en anglais, espagnol, ou le Français visitez la section de soutien à [www.ilive.net](http://www.ilive.net).