

Stereo Cassette Deck

Operating Instructions

*TC-WE675
TC-WE475*

Warning

To prevent fire or shock hazard, do not expose the unit to rain or moisture.

To prevent fire, do not cover the ventilation of the apparatus with news papers, table-cloths, curtains, etc. And don't place lighted candles on the apparatus.

To prevent fire or shock hazard, do not place objects filled with liquids, such as vases, on the apparatus.

Do not install the appliance in a confined space, such as a bookcase or built-in cabinet.

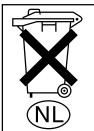

Don't throw a battery, dispose it as the injurious wastes.

NOTICE FOR THE CUSTOMERS IN THE U.S.A.

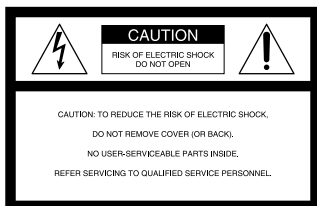

This symbol is intended to alert the user to the presence of uninsulated "dangerous voltage" within the product's enclosure that may be of sufficient magnitude to constitute a risk of electric shock to persons.



This symbol is intended to alert the user to the presence of important operating and maintenance (servicing) instructions in the literature accompanying the appliance.

Owner's Record

The model and serial numbers are located on the rear panel of the unit. Record the serial number in the space provided below. Refer to them whenever you call upon your Sony dealer regarding this product.

Model No. _____

Serial No. _____

INFORMATION

This equipment has been tested and found to comply with the limits for a Class B digital device, pursuant to Part 15 of the FCC Rules. These limits are designed to provide reasonable protection against harmful interference in a residential installation. This equipment generates, uses, and can radiate radio frequency energy and, if not installed and used in accordance with the instructions, may cause harmful interference to radio communications. However, there is no guarantee that interference will not occur in a particular installation. If this equipment does cause harmful interference to radio or television reception, which can be determined by turning the equipment off and on, the user is encouraged to try to correct the interference by one or more of the following measures:

- Reorient or relocate the receiving antenna.
- Increase the separation between the equipment and receiver.
- Connect the equipment into an outlet on a circuit different from that to which the receiver is connected.
- Consult the dealer or an experienced radio/TV technician for help.

CAUTION

You are cautioned that any changes or modification not expressly approved in this manual could void your authority to operate this equipment.

NOTICE FOR THE CUSTOMERS IN CANADA

CAUTION:

TO PREVENT ELECTRIC SHOCK, DO NOT USE THIS POLARIZED AC PLUG WITH AN EXTENSION CORD, RECEPTACLE OR OTHER OUTLET UNLESS THE BLADES CAN BE FULLY INSERTED TO PREVENT BLADE EXPOSURE.

About this manual

The instructions in this manual are for models TC-WE675 and WE475. Check your model number by looking at the rear panel of your tape deck. In this manual, the TC-WE675 is the model used for illustration purposes. Any difference in operation is clearly indicated in the text, for example, "TC-WE675 only."

Table of Contents

Parts Identification

Main unit	4
-----------------	---

Getting Started

Hooking up the system	6
-----------------------------	---

Playing a Tape

Playing a tape	7
Locating a track	
— Multi-AMS/Auto Play/ Memory Play	8
Creating your own program	
— RMS Play (TC-WE675 only)	8

Recording on a Tape

Recording on a tape	10
Adjusting bias and recording level calibration automatically (TC-WE675 only)	11
Adjusting the recording level automatically	
— Auto Rec Level	12
Fading in and out — Fader	13
Dubbing a tape	14
Recording on both decks in succession	
— Relay Recording (TC-WE675 only)	15
Recording the same source on both decks	
— Simultaneous Recording (TC-WE675 only)	15
Recording your own program	
— RMS Dubbing (TC-WE675 only)	16
Inserting a blank space during recording	
— Record Muting	16
Using the CONTROL A1II control system	17

Additional Information

Precautions	20
Troubleshooting	22
Specifications	23

The items are arranged in alphabetical order.

Refer to the pages indicated in parentheses () for details.

Main unit

TC-WE675

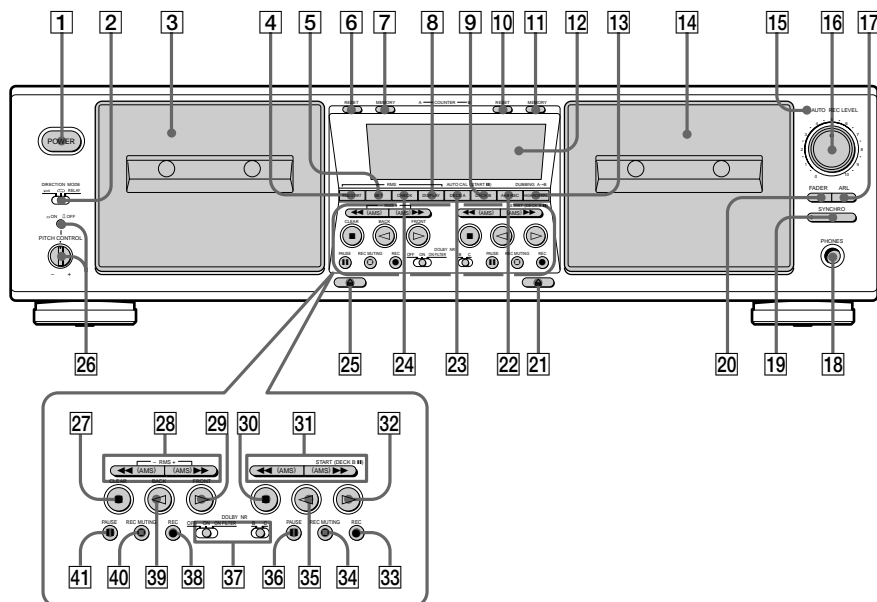

A + B REC **22** (15)
 ARL **17** (12)
 AUTO indicator **15** (10, 12)
 CHECK **24** (9)
 Deck A **3** (7, 20)
 Deck A **23** (11)
 Deck B **14** (10, 20)
 DECK B **9** (11)
 DIRECTION MODE **2** (7, 10)
 Display **12**
 DISPLAY **8** (9)
 DOLBY NR **37** (7, 10)
 FADER **20** (13)
 HIGH/NORMAL **13** (14)
 MEMORY (on deck A) **7** (8)
 MEMORY (on deck B) **11** (8)
 PHONES jack **18**
 PITCH CONTROL **26** (7)
 POWER **1** (7, 10)
 REC LEVEL **16** (11, 12)

RESET (on deck B) **6** (8)
 RESET (on deck B) **10** (8)
 RMS/START **4** (8, 16)
 SET **5** (9)
 SYNCHRO **19** (18)

BUTTON DESCRIPTIONS

⊕ (eject on deck B) **21** (7, 10, 21)
 ⊖ (eject on deck A) **25** (7, 10, 21)
 ■ (stop on deck A)/CLEAR **27** (7, 9, 10, 12)
 ►► (go forward)/AMS/RMS +/◀◀ (go back)/AMS/RMS - (on deck A) **28** (7, 8)
 ▷ (play on deck A)/FRONT **29** (7, 8, 10, 11)
 ■ (stop on deck B) **30** (7, 10, 12)
 ►► (go forward)/AMS/◀◀ (go back)/AMS (on deck B) **31** (7, 8)

▷ (play on deck B) **32** (7, 10, 11)
 ● REC (on deck B) **33** (10)
 ○ REC MUTING (on deck B) **34** (16)
 ◁ (reverse play on deck B) **35** (7, 10, 11)
 ■ PAUSE (on deck B) **36** (7, 10, 11)
 ● REC (on deck A) **38** (10)
 ◁ (reverse play on deck A)/BACK **39** (7, 8, 10, 11)
 ○ REC MUTING (on deck A) **40** (16)
 ■ PAUSE (on deck A) **41** (7, 10, 11)

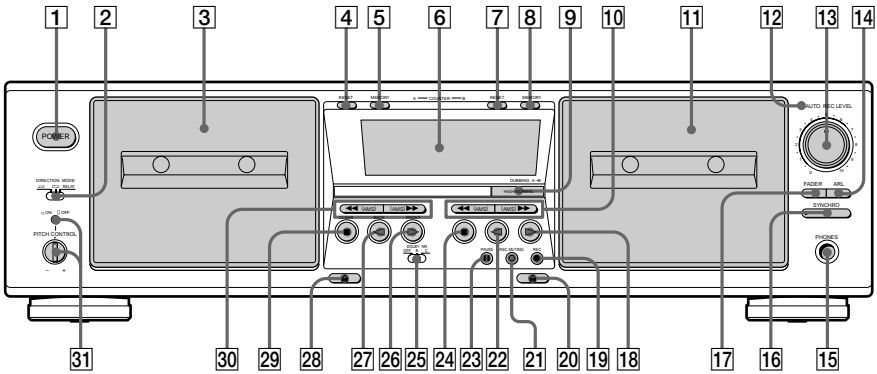

- ARL **14** (12)
- AUTO indicator **12** (10, 12)
- Deck A **3** (7, 20)
- Deck B **11** (10, 20)
- DIRECTION MODE **2** (7, 10)
- Display **6**
- DOLBY NR **25** (7, 10)
- FADER **17** (13)
- HIGH/NORMAL **9** (14)
- MEMORY (on deck A) **5** (8)
- MEMORY (on deck B) **8** (8)

- PHONES jack **15**
- PITCH CONTROL **31** (7)
- POWER **1** (7, 10)
- REC LEVEL **13** (11, 12)
- RESET (on deck A) **4** (8)
- RESET (on deck B) **7** (8)
- SYNCHRO **16** (18)

BUTTON DESCRIPTIONS

- ▶▶** (go forward)/AMS/ **◀◀** (go back)/AMS (on deck B) **10** (7, 8)
- ▷** (play on deck B) **18** (7, 10)
- REC (on deck B) **19** (10)
- ⊞** (eject on deck B) **20** (7, 10, 21)
- REC MUTING (on deck B) **21** (16)
- ◁** (reverse play on deck B) **22** (7, 10)
- ||** PAUSE (on deck B) **23** (7)
- (stop on deck B) **24** (7, 10)
- ▷** (play on deck A) **26** (7)
- ◁** (reverse play on deck A) **27** (7)
- ⊞** (eject on deck A) **28** (7)
- (stop on deck A) **29** (7)
- ▶▶** (go forward)/AMS/ **◀◀** (go back)/AMS (on deck A) **30** (7, 8)

Hooking up the system

This section describes how to hook up the tape deck to an amplifier or a CD player equipped with CONTROL A1II connectors. Be sure to turn off the power of each component before making the connections.

Hookups

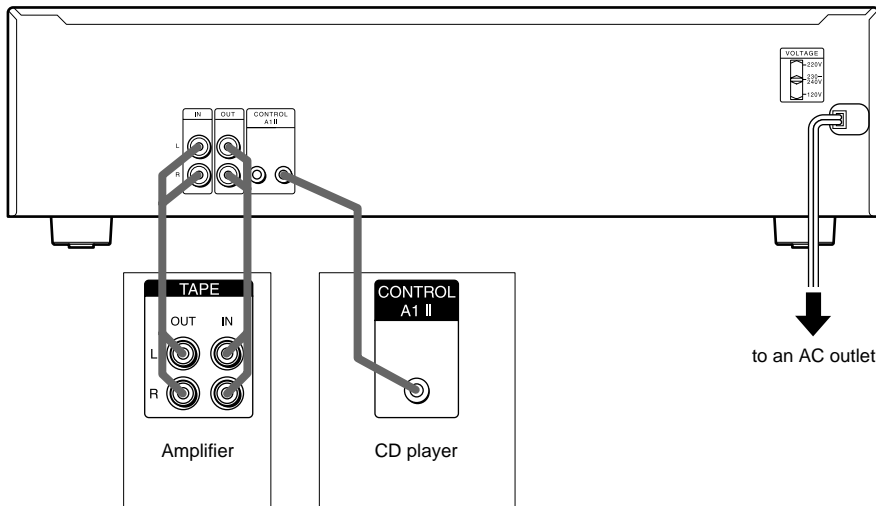

Connecting the tape deck to an amplifier

Connect the amplifier to the IN/OUT connectors using the supplied audio connecting cords.

When connecting an audio connecting cord, be sure to match the color-coded cord to the appropriate jacks on the components: Red (right) to Red and White (left) to White. Be sure to make connections firmly to avoid hum and noise.

Connecting the tape deck to a CD player equipped with CONTROL A1II connectors

For details, see “Using the CONTROL A1II control system” on page 17.

Setting the voltage selector (only on models supplied with a voltage selector)

Check that the voltage selector on the rear panel of the tape deck is set to the local power line voltage. If not, set the selector to the correct position using a screwdriver before connecting the AC power cord to an AC outlet.

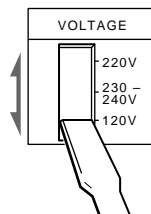

Connecting the AC power cord

Connect the AC power cord to an AC outlet.



Playing a tape

- 1 Turn on the amplifier and select the tape deck position.
- 2 Press POWER, and press  fully to open the cassette holder, then load a cassette.

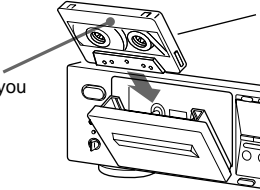
With the side you want to play facing you



- 3 Set DIRECTION MODE.







To play back	Set to
One side only	
Both sides continuously ¹⁾	
Both decks in succession ¹⁾	RELAY

¹⁾ The deck automatically stops after playing back five times.

- 4 Press .

The deck starts playing. Adjust the volume on the amplifier.

Do not press POWER or  while the tape deck is operating. If you do so, the tape may be damaged.

To	Press
Stop playing	
Start playback from the reverse side	
Pause	 PAUSE. Press the button again to resume play.
Fast-forward or rewind	 or  when the deck is stopped
Take out the cassette	 after stopping playing

Tips

- Push in PITCH CONTROL to activate the Pitch Control function and turn the control clockwise to raise the pitch or counterclockwise to lower it. You can adjust the pitch during playback on deck A or normal-speed dubbing (but not during RMS play²⁾ or RMS dubbing²⁾.
²⁾ TC-WE675 only
- To play a tape recorded with the Dolby³⁾ NR, set DOLBY NR to ON (TC-WE675 only) and select the same position that the tape was recorded in—B or C.
³⁾ “Dolby”, “HX Pro”, and the double-D symbol are trademarks of Dolby Laboratories.

Locating a track

— Multi-AMS/Auto Play/Memory Play

You can locate the following/previous tracks within a range of 30 tracks (Multi-AMS: Automatic Music Sensor) or the beginning of a tape quickly (Auto Play). You can even locate a specific point anywhere on a tape (Memory Play).

Note

Check the direction indicator of the deck you use. When you locate a track on the reverse side (when ◁ lights up), press the button(s) in the parentheses.

To locate	Press
The beginning of the next or succeeding tracks (Multi-AMS)	▶▶ (or ◀◀) as many times as you want during playback. For example, to locate 2 tracks ahead, press twice.
The beginning of the current track (Multi-AMS)	◀◀ (or ▶▶) once during playback.
The beginning of the preceding tracks (Multi-AMS)	◀◀ (or ▶▶) as many times as you want during playback. For example, to locate 2 tracks behind, press three times.
The beginning of a tape (Auto Play)	MEMORY repeatedly until "M" disappears in the display. Then press ◀◀ (or ▶▶) while holding down ▷ (or ◁).
A particular point on a tape (Memory Play)	MEMORY repeatedly until "M" appears in the display. Find the point you want, then press RESET to reset the tape counter and to memorize the point. To locate the memorized point and start playback, press ◀◀ (or ▶▶) while holding down ▷ (or ◁). (Press ◀◀ or ▶▶ to stop at "0000".)

Notes

- The Multi-AMS function may not work correctly if:
 - the blank space between tracks is less than 4 seconds long.
 - there is a passage of low frequencies or very low volume within a track.
 - the signal strength of the left and right channels are very different.
- The Multi-AMS function is inoperative on a deck whenever the other deck is playing, recording (except during dubbing), or in pause.
- Even if DIRECTION MODE is set to S, the deck stops when the current side reaches the end during Multi-AMS operation.
- The tape counters are reset to "0000" when you turn off the tape deck.

Creating your own program

— RMS Play

(TC-WE675 only)

By creating a program, you can play back tracks on deck A in any order that you want. The Random Music Sensor (RMS) function lets you create a program of up to 28 tracks, from the 1st to the 14th tracks on each side of the tape.

1 Press RMS/START.

"RMS" and a flashing cursor appear in the display.

2 Press ◁ (BACK) or ▷ (FRONT) to select the side of the tape.

◁ or ▷ appears in the display.

3 Press ◀◀ or ▶▶ repeatedly until the track number you want appears in the display.

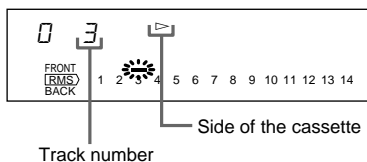

4 Press SET to store your selection.

To program the same track again, press SET once more.

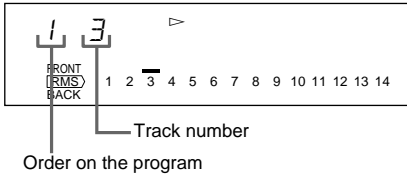

5 Repeat Steps 2 to 4 to program more tracks.

If "FULL" appears in the display
This means that you've already programmed 28 tracks and can't program any more.

6 Press RMS/START to start RMS Play.

The peak level meters appear in the display.

To stop RMS Play

Press ■ (CLEAR) once. The RMS program still remains. To resume RMS play, press RMS/START.

To cancel RMS Play

Press ■ (CLEAR) repeatedly until the peak level meters appear in the display or eject the tape in deck A. When RMS Play is canceled, the RMS program is automatically erased.

To alternate between the RMS and peak level meter displays

Press DISPLAY.

Tip

To play the program again after RMS Play ends, press RMS/START.

Notes

- During RMS Play, you can only use CHECK, DISPLAY, and ■ on deck A, and ■, ◀◀, and ▶▶ on deck B.
- The RMS function may not work properly if a blank space between tracks is short.
- If there is a long blank space between tracks, the deck may fast-forward a portion of the blank space.
- If your program includes a number for a track that does not exist, the deck will skip that number during RMS Play.

Checking the order of tracks in the program

Press CHECK.

Each time you press this button, the display shows the track numbers in the order they were programmed. After the last track in the program, "End" appears in the display.

Adding tracks to the end of a program

Press ■ (CLEAR) once, and follow Steps 2 to 5 in "Creating your own program (RMS Play)" on page 8.

Note

For more information on the availability of Sony stereo receiver remotes with RMS capability, contact your nearest Sony dealer.

Recording on a tape

- 1 Turn on the amplifier and play the program source you want to record.
- 2 Press **POWER**, and press \triangle fully to open the cassette holder, then load a cassette.¹⁾

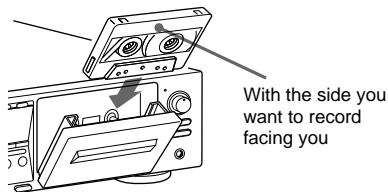

- ¹⁾ On the TC-WE675, you can record on both decks.
On the TC-WE475, you can record only on deck B.

- 3 Set **DIRECTION MODE**.

To record on	Set to
Only one side	\rightleftarrows
Both sides ²⁾	\hookrightarrow

- ²⁾ Recording stops when the tape reaches the end of reverse side.

- 4 Press **● REC**.

\triangleright lights up for recording on the side facing you. If it doesn't, press \triangleright once.

The tape deck automatically adjusts the recording level (see page 12). After the **AUTO** indicator lights up continuously, stop playing the program source. If you wish to adjust the recording level manually, see "To adjust the recording level manually" on page 11.

Do not press POWER or \triangle while the tape deck is operating. If you do so, the tape may be damaged.

- 5 Press **II PAUSE** or \triangleright .

Recording starts.

- 6 Start playing the program source.

To	Press
Stop recording	■
Start recording from the reverse side	\triangleleft twice in Step 5
Pause	II PAUSE . Press the button again to resume recording.
Take out the cassette	\triangle after stopping recording

Tip

To protect recordings against accidental erasure, break out the record-protect tab(s) (see page 20).

To record with the **Dolby NR**

Set **DOLBY NR** to **ON** (TC-WE675 only), and select **B** or **C** before you start recording.

To record FM broadcasts with the **Dolby NR** (TC-WE675 only)

If the FM reception is unsatisfactory, set **DOLBY NR** to **ON FILTER** (multiplex filter).

Tip

The **Dolby HX Pro**³⁾ automatically works during recording.

Distortion and noise in the high-frequency response are reduced to produce high-quality sound that can be enjoyed even during playback on other tape decks.

³⁾ Manufactured under license from Dolby Laboratories.

HX Pro headroom extension originated by Bang & Olufsen.

"Dolby", "HX Pro", and the double-D symbol are trademarks of Dolby Laboratories.

To adjust the recording level manually

After pressing ● REC in Step 4 on page 10, turn REC LEVEL so that the peak level meters reach the recommended level for the corresponding tape type. After completing the adjustments, stop playing the program source, then continue the procedure from Step 5.

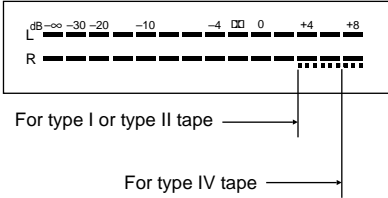

Note

Even after adjusting the recording level, distortion may occur depending on the source that you're recording from. If this happens, turn REC LEVEL counterclockwise to lower the level.

Adjusting bias and recording level calibration automatically

(TC-WE675 only)

Since there are many different types of cassettes on the market, your tape deck automatically sets the appropriate equalization characteristics and bias current for each tape type (ATS: Automatic Tape Selection). However, you can get better recording results by doing the automatic bias current and the recording level calibration.

- 1 Load the cassette you want to record on into either deck.**
Make sure the record-protect tabs on the cassette have not been removed.
- 2 Press DECK A or DECK B until "CAL" appears in the display.**
- 3 Press ▷ or ◁ to select the side of the tape to be recorded.**

To select	Press
The front side	▷
The reverse side	◁

4 Press II PAUSE.

The automatic calibration procedure starts (i.e., recording test tones, rewinding, and playing back).

During the calibration, the counter changes from 9 to 0.

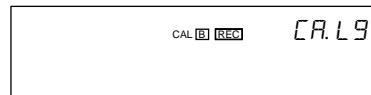

When the automatic calibration procedure ends, the tape rewinds to the original position, the counter returns to normal and the tape deck stops.

continued

Adjusting bias and recording level calibration automatically (continued)

5 Start the actual recording (see page 10).

To cancel the Automatic Calibration function

Press ■ on the deck you're using.

If "A" or "B" flashes continuously

The automatic calibration procedure has been interrupted by:

- The end of the tape. Reverse the tape direction or rewind the tape to a new position that allows recording of the test tone.
- Damaged tape or dirty heads. Change the cassette or clean and demagnetize the heads (see page 21).

Updating the calibration setting

If you load a cassette and "A CAL" or "CAL B" appears in the display, it means that automatic calibration data in that deck for that tape type (I, II or IV) exists. However, we recommend that you repeat the automatic calibration procedure each time you load a new cassette since cassettes of the same type also vary in their characteristics.

Before recalibrating, be sure to turn off "A CAL" or "CAL B" by pressing the DECK A or DECK B button. Then start from Step 2 of the automatic calibration procedure.

Adjusting the recording level automatically

— Auto Rec Level

The Auto Rec Level function automatically measures the peak signal level and adjusts the recording level accordingly. The Auto Rec Level function operates during normal recording, Relay Recording* or Simultaneous Recording* on either deck.

* TC-WE675 only

1 Follow Steps 1 to 3 of "Recording on a tape" on page 10.

Make sure that record-protect tabs on the cassette have not been removed.

2 Press ● REC.

The AUTO indicator flashes and the deck automatically adjusts the recording level. The AUTO indicator lights up continuously after the recording level has been adjusted.

3 Press II PAUSE or ▷.

Recording starts.

To cancel the Auto Rec Level function

Press ARL or turn REC LEVEL to turn off the AUTO indicator. If you do either of these during recording, recording will continue but with the Auto Rec Level function turned off.

To stop recording

Press ■.

Tips

- You should adjust the recording level manually with REC LEVEL in the following cases:
 - The recording level cannot be adjusted properly due to excessive noise in the program source.
 - The program source level is too low and the recording level does not increase.

During a quiet passage in a program source such as classical music, the recording level may not increase for some time. If a high sound level is expected later on in the track, play that portion first so that the right adjustment can be obtained.
 - The recording level does not decrease for a long time. The Auto Rec Level function may not work properly when you try to record sound produced by a graphic equalizer that has extremely high-level signals.
- To prevent changes in the recording level after recording starts, press ● REC while playing the highest sound level portion of the program source to be recorded. The result is a more natural-sounding recording.
- If you play the entire program source after the AUTO indicator has stopped flashing and is lit continuously, the deck will set the recording level for the portion of the program source with the highest signal level.
- After you have finished recording with the Auto Rec Level function, the AUTO indicator remains on and the recording level setting remains the same. To cancel the setting, do one of the following:
 - Press ARL to turn off the AUTO indicator
 - Turn REC LEVEL
 - Turn the deck off.

Fading in and out

— Fader

You can gradually increase the recording level at the beginning of a recording (fade in) or gradually decrease the recording level at the end of a recording (fade out).

It is convenient to use this function, for example, when the tape reaches to its end and you don't want the track to be cut off abruptly.

To	Do the following:
Fade in	<ol style="list-style-type: none"> 1 Follow Steps 1 to 4 of “Recording on a tape” on page 10. 2 Start playing the program source and press FADER at the point where you want the fade-in to start. During fade-in, the AUTO indicator flashes. When the fade-in has completed, the AUTO indicator lights up if the Auto Rec Level function is working, or goes off if the Auto Rec Level function is not working.
Fade out	While you're still recording, press FADER at the point where you want the fade-out to start. When the fade-out has completed, “REC” flashes in the display and the deck pauses.

Note

Fade-in or fade-out is not possible when REC LEVEL is manually set to 0 (minimum) (see page 11).

Dubbing a tape

You can copy a tape in deck A to a tape in deck B at normal or high speed.

1 Load a recorded cassette into deck A and a blank cassette into deck B.

Make sure the record-protect tabs on the cassette in deck B have not been removed.

2 Select the side(s) to be recorded on.

To record on	Set DIRECTION MODE to
One side	⇌
Both sides	↻

Recording on the reverse side on deck B starts independently of playback on deck A.

RELAY.

Recording on the reverse side on deck B starts simultaneously with playback of the reverse side on deck A.

3 Select the dubbing speed.

To select	Press HIGH/NORMAL
Normal speed	Once
High speed	Twice

“HIGH” or “NORM” appears in the display.

The deck changes to dubbing standby.

4 Select the side from which to start dubbing.

To record from	Press
The front side	▷
The reverse side	◁

5 Press **II PAUSE** on deck B to start dubbing.

To stop dubbing

During	Press
Normal-speed dubbing	■ on deck B
High-speed dubbing	■ on either deck

Tips

- During high-speed dubbing, only ■ is operative.
- Dubbing is automatically performed with the same recording level and Dolby NR as the original in deck A. You don't have to adjust the recording level or select the Dolby NR during dubbing. If, however, you want to monitor the sound during normal-speed dubbing, set the DOLBY NR selector to match the tape in deck A (see page 7).
- You can adjust the pitch of the playback on deck A. See page 7.

Note

If a TV set is placed near the tape deck, noise may occur during high-speed dubbing. In that case, turn the television set off or move it away from the tape deck.

Dubbing only specific portions

You can do this only during the normal-speed dubbing.

1 Press ■ on deck A at the portion you want to skip.

Deck B changes to recording pause.

2 Locate the point you want to resume recording on deck A, then stop the tape.

3 Press **II PAUSE** on deck B to resume dubbing.

Recording on both decks in succession

— Relay Recording

(TC-WE675 only)

You can make a continuous recording that starts on a cassette in deck A and ends on a cassette in deck B.

- 1 Load blank cassettes into both decks.**
Make sure that record-protect tabs on the cassettes have not been removed.
- 2 Select the Dolby NR (see page 10).**
- 3 Set DIRECTION MODE to RELAY.**
- 4 Press ● REC on deck A.**
Deck A changes to recording pause.
- 5 Start playing the program source.**
- 6 Adjust the recording level manually, if necessary (see page 11).**
- 7 Start recording.**

To record from	Press
The front side	▷ on deck A
The reverse side	◁ on deck B

To stop Relay Recording

During	Press
Recording on deck A	■ on deck A
Recording on deck B	■ on deck B

Note

Make sure that ▷ on deck B appears in the display. If it doesn't, press ▷ on deck B once; otherwise, Relay Recording stops when the reverse side of the cassette in deck B finishes.

Recording the same source on both decks

— Simultaneous Recording

(TC-WE675 only)

You can record the same source on cassettes in deck A and B at the same time.

- 1 Load blank cassettes into both decks.**
Make sure that record-protect tabs on the cassettes have not been removed.
- 2 Select the Dolby NR (see page 10).**
- 3 Select the side(s) to be recorded on.**

To record on	Set DIRECTION MODE to
Only one side	⇄
Both sides	↻

- 4 Press A+B REC.**
Both decks change to recording pause.
- 5 Start playing the program source.**
- 6 Adjust the recording level manually, if necessary (see page 11).**
- 7 Select the side you want to start recording from on both decks.**

To record from	Press
The front side	▷
The reverse side	◁

- 8 Press ■ PAUSE on deck B.**
Simultaneous Recording starts.

To stop Simultaneous Recording

Press ■ on both decks.

Tip

During Simultaneous Recording, ■ PAUSE and ○ REC MUTING on deck B control both decks, but not ■ PAUSE and ○ REC MUTING on deck A.

Recording your own program

— RMS Dubbing

(TC-WE675 only)

You can record an RMS program that you've created (see "Creating your own program (RMS Play)" on page 8). This function works only at normal speed.

- 1 Load a recorded cassette into deck A and a blank cassette into deck B.**
Make sure the record-protect tabs on the cassette in deck B have not been removed.
- 2 Program tracks on deck A (see Steps 1 to 5 on page 8).**
- 3 Press HIGH/NORMAL once to change the tape deck to dubbing standby.**
- 4 Select the side of the tape in deck B you want to record on.**

To start recording	Press
On the front side	▷
On the reverse side	◁

- 5 Press RMS/START or II PAUSE on deck B to start RMS Dubbing.**

To stop RMS Dubbing

Press ■ on deck B. The RMS program remains even after RMS Dubbing stops.

Tips

- You can insert a blank space of 4 seconds or more on the tape in deck B by pressing ○ REC MUTING after Step 4.
For details, see "Inserting a blank space during recording (Record Muting)" on page 16.
- A blank of 10 seconds is automatically inserted on the tape when you start RMS Dubbing if:
 - you load a new cassette into deck B.
 - the tape in deck B is completely rewound to its beginning and automatically stopped.

Inserting a blank space during recording

— Record Muting

You can insert a blank space of 4 seconds between the tracks. The blank spaces allow you to locate the start of specific tracks afterwards using the Multi-AMS function (see page 8). You can also use this function to erase unwanted portions on a tape.

- 1 Follow Steps 1 to 5 of "Recording on a tape" on page 10.**
Recording starts.
- 2 Press ○ REC MUTING where you want to load a blank space.**
"REC" flashes in the display and a blank is recorded on the tape.
After 4 seconds, II lights up and the tape deck changes to recording pause.
- 3 Press II PAUSE to resume recording.**

Tip

If you want to insert a blank space longer than 4 seconds, hold down ○ REC MUTING as long as you want. After 4 seconds, "REC" flashes faster. When you release ○ REC MUTING, II lights up and the tape deck changes to recording pause. Press II PAUSE to resume recording.

Using the CONTROL A1II control system

This cassette deck is compatible with the CONTROL A1II Control System.

The CONTROL A1II control system was designed to simplify the operation of audio systems composed of separate Sony components. CONTROL A1II connections provide a path for the transmission of control signals that enable automatic operation and control features usually associated with integrated systems.

Currently, CONTROL A1II connections between a Sony MD deck, CD player, amplifier (receiver), and cassette deck provide automatic function selection and synchronized recording.

In the future the CONTROL A1II connection will work as a multifunction bus allowing you to control various functions for each component.

Note

The CONTROL A1II control system is designed to maintain upward compatibility as the control system is upgraded to handle new functions. In this case, however, older components will not be compatible with the new functions.

CONTROL A1II and CONTROL A1 compatibility

The CONTROL A1 control system has been updated to the CONTROL A1II which is the standard system in the Sony 300 disc CD changer and other recent Sony components. Components with CONTROL A1 jacks are compatible with components with CONTROL A1II, and can be connected to each other. Basically, the majority of the functions available with the CONTROL A1 control system will be available with the CONTROL A1II control system. However, when making connections between components with CONTROL A1 jacks and components with CONTROL A1II jacks, the number of functions that can be controlled may be limited depending on the component. For detailed information, refer to the operating instructions supplied with the component(s).

continued

Using the CONTROL A1II control system (continued)

Connecting the CONTROL A1II control system

Connect monaural (2P) mini-plug cables in series to the CONTROL A1II jacks on the back of each component. You can connect up to ten CONTROL A1II compatible components in any order. However, you can connect only one of each type of component (i.e., 1 CD player, 1 MD deck, 1 tape deck and 1 receiver). (You may be able to connect more than one CD player or MD deck, depending on the model. Refer to the operating instructions supplied with the respective component for details.)

Example

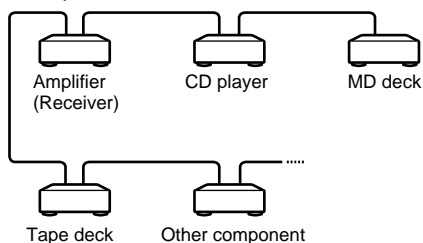

In the CONTROL A1II control system, the control signals flow both ways, so there is no distinction of IN and OUT jacks. If a component has more than one CONTROL A1II jack, you can use either one, or connect different components to each jack.

About the connecting cable

When a CONTROL A1II compatible component is not supplied with a connecting cable, use a commercially available monaural (2P) mini-plug cable less than 2 meters (6.6 feet) long, with no resistance (such as the Sony RK-G69HG).

Synchro-recording with a CD player

By pressing SYNCHRO, you can perform synchro-recording on your tape deck with a Sony CD player connected to the CONTROL A1II connector through a CONTROL A1II cable.

- 1 Set the source selector on the amplifier to CD player.
- 2 Load a CD into the CD player.
- 3 Select the play mode (CONTINUE, SHUFFLE, or PROGRAM) of the CD player.
- 4 Load a cassette into deck B.
- 5 Select the side(s) to be recorded on.

To record on	Set DIRECTION MODE to
Only one side	⇐
Both side	↔ or RELAY

- 6 Select the side you want to start recording from on deck B.

To record from	Press
The front side	▷
The reverse side	◁

- 7 Press SYNCHRO.

To stop CD Synchro-recording Press ■ on deck B or the CD player.

Tips

- If the indicator on SYNCHRO goes off after flashing rapidly, the tape cannot be recorded on because the record-protect tab(s) on the cassette has (have) been removed.
- Tracks on a CD differ in length. Classical music CDs and others often have tracks that exceed the recording time of a single cassette side. In this case, record the tape manually.
- A tape that is loaded and has not been played or recorded on is assumed by the deck to be a new tape, even if the present location is in the middle of the tape. The deck will transport the tape for 10 seconds before starting CD Synchro-recording to bypass the portion corresponding with the leader. To begin CD Synchro-recording without the ten-seconds delay, play or record on the tape for about 10 seconds before starting the CD Synchro-recording procedure.
- If the tape ends during CD Synchro-recording on the front side of the tape (▷ lights up) and DIRECTION MODE is set to ↻ or RELAY, recording of the track ends immediately, the tape direction is reversed, and recording starts again from the beginning of the track. If the tape ends on the reverse side of the tape (◁ lights up), CD Synchro-recording stops and the CD player stops playing.

Notes

- To prevent interruption of the recording process, do not press any operation buttons on the CD player during CD Synchro-recording.
- Certain operation buttons on the tape deck are disabled during CD Synchro-recording

Automatic function selection

When you connect CONTROL A111 compatible Sony components using CONTROL A111 cables (not supplied), the function selector on the amplifier (or receiver) automatically switches to the correct input when you press the play button on one of the connected components.

(For example, when you press ▷ (play button) on the cassette deck while the CD is playing, the function selector on the amplifier switches from CD to TAPE.)

Notes

- This function works only when the components are connected to the amplifier (or receiver) inputs according to the names on the function buttons. Certain receivers allow you to switch the names of the function buttons. In this case, refer to the operating instructions supplied with the receiver.
- When recording, do not play any components other than the recording source. It will cause the automatic function selection to operate.

Precautions

On safety

- Do not disassemble the cabinet — this may result in an electrical shock. Refer servicing to qualified personnel only.
- Should any solid object or liquid fall into the cabinet, unplug the tape deck and have it checked by qualified personnel before operating it any further.

On power sources

- Before operating the tape deck, check that the operating voltage of the tape deck is identical with your local power supply. The operating voltage is indicated on the nameplate at the rear of the tape deck.
- The unit is not disconnected from the AC power source (mains) as long as it is connected to the wall outlet, even if the unit itself has been turned off (U.S.A. and Canadian models only).
- If you are not going to use the tape deck for a long time, be sure to disconnect the tape deck from the wall outlet. To disconnect the AC power cord, grasp the plug itself; never pull the cord.
- AC power cord must be changed only at the qualified service shop.

On operation

- Because of a safety mechanism, the function buttons will not operate if the cassette holder is not completely closed, if there is no cassette in the cassette holder, or if a cassette has been incorrectly loaded into the cassette holder.
- Be sure to stop the tape before turning off the tape deck. Otherwise, the tape may be damaged.

On placement

- Place the tape deck in a location with adequate ventilation to prevent heat build-up in the tape deck.
- Do not place the tape deck:
 - on a soft surface such as a rug that might block the ventilation holes on the bottom.
 - in a location near heat sources.
 - in a place subject to direct sunlight.
 - in an inclined position.
 - in a place subject to excessive dust or mechanical shock.

On cleaning the tape deck

Clean the cabinet, panel and controls with a soft cloth slightly moistened with a mild detergent solution. Do not use any type of abrasive pad, scouring powder or solvent such as alcohol or benzine.

If you have any questions or problems concerning your tape deck, please consult your nearest Sony dealer.

Notes on Cassette Tapes

To protect a recording on side A or B
Break out the respective tab.

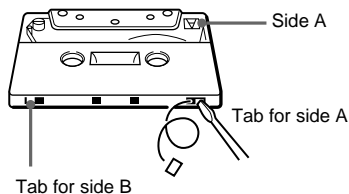

To record on a tape with a missing record-protect tab

Cover the respective tab hole with adhesive tape.

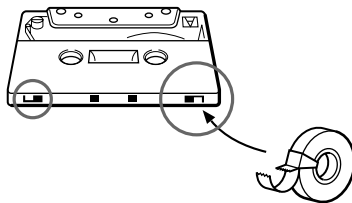

ing the heads and tar

Head assembly

ch rollers

astans



1 Press  to open the cassette holder.

2 With the tape deck turned off, wipe the heads, the pinch rollers and the capstans with a cotton swab slightly moistened with alcohol or a commercially available cleaning fluid for tape decks.

Demagnetizing the heads

After 20 to 30 hours of use, or when you notice a hissing sound or loss of high frequencies, demagnetize the heads with a commercially available demagnetizer for tape decks. Please refer to the instructions of the demagnetizer.

Additional Information

Clean the heads and tape path of the tape deck after every 10 hours of operation to guard against:

- low-quality sound
- a decrease in sound level
- excessive wow or flutter
- sound dropout
- incomplete erasure
- impairment of recording function

To ensure better recording, we recommend that you clean the heads and tape path before every recording.

Troubleshooting

If you've experienced any of the following difficulties while using the tape deck, use this troubleshooting guide to help you remedy the problem. Should the problem persist, consult your nearest Sony dealer.

The function buttons do not work.

- The tape deck has been just turned on and does not operate for about 3 seconds. Wait until ■■ stops flashing.
- Check that the cassette is loaded correctly and the cassette holder is closed completely.

The tape deck does not play or record.

- There is no cassette in the cassette holder.
- The tape has come to the end.
- The tape is slack. Take up the tape slack.
- The record-protect tab has been removed from the cassette (see page 20).
- Make sure the amplifier setting is correct.
- Check that the tape deck connections are secure.
- The heads and tape path are dirty. Clean them (see page 21).
- The recording/playback head is magnetized. Demagnetize it (see page 21).

There is excessive wow, flutter or sound drop-out.

- The capstans and pinch rollers are dirty. Clean them (see page 21).

There is a decrease in sound level, sound drop-out, or poor reproduction of high frequencies./ The tape does not erase completely./Noise increases.

- The recording/playback or erasing head and tape path are dirty. Clean them (see page 21).
- The recording/playback or erasing head is magnetized. Demagnetize it (see page 21).

There is hum or noise.

- The tape deck is placed near a TV or VCR. Move the tape deck away from the TV or VCR.
- The tape deck is placed on or under the amplifier. Move the tape deck away from the amplifier.

The tape stops before the tape has been fully rewound.

- The tape is slack. Take up the tape slack.
- If "M" is shown in the display, press MEMORY repeatedly until "M" disappears.
- The cassette shell is bent. Use another cassette.

The Multi-AMS function does not work properly.

- One of the tracks contains a long pause, a passage of low frequencies or very low volume, or a gradual increase or decrease in volume.
- The space before a track is less than 4 seconds long. Load a blank space of 4 seconds using **REC MUTING**.
- The signal strength of the left and right channels are very different.
- There is noise in the space before a track.
- You pressed **▶▶** (or **◀◀**) immediately before the beginning of the next track or immediately after the beginning of the current track.

The Dolby NR function does not work properly during playback.

- The Pitch Control function is on and the frequency characteristics of the sound is altered. Push **PITCH CONTROL** again to turn off the function.

There is excessively loud tape transport noise during fast-forwarding or rewinding.

- This noise is caused by the cassette and is not a mechanical problem.
-

Specifications

System

Fast-winding time	Approx. 100 sec. (with Sony C-60 cassette)
Signal-to-noise ratio (at peak level and weighted with Dolby NR off)	55 dB, using Sony TYPE I cassette 57 dB, using Sony TYPE II cassette 58 dB, using Sony TYPE IV cassette
S/N ratio improvement	With Dolby B NR on: Approx. 5 dB at 1 kHz, 10 dB at 5 kHz With Dolby C NR on: Approx. 15 dB at 500 Hz, 20 dB at 1 kHz
Harmonic distortion	0.4% (using Sony TYPE I cassette): 160 nWb/m 315 Hz, 3rd H.D.) 1.8% (using Sony TYPE IV cassette): 250 nWb/m 315 Hz, 3rd H.D.)
Frequency response (DOLBY NR OFF)	30-16,000 Hz (± 3 dB, IEC), 20-17,000 Hz (± 6 dB), using Sony TYPE I cassette 30-17,000 Hz (± 3 dB, IEC), 20-18,000 Hz (± 6 dB), using Sony TYPE II cassette 30-19,000 Hz (± 3 dB, IEC), 20-20,000 Hz (± 6 dB), 30-13,000 Hz (± 3 dB, -4dB recording), using Sony TYPE IV cassette
Wow and flutter	
TC-WE675:	$\pm 0.13\%$ W. Peak (IEC) 0.1% W. RMS (NAB) $\pm 0.2\%$ W. Peak (DIN)
TC-WE475:	$\pm 0.15\%$ W. Peak (IEC) 0.1% W. RMS (NAB) $\pm 0.2\%$ W. Peak (DIN)
Variable pitch range	Approx. -30 to +30 %

Inputs

Line inputs (phono jacks) sensitivity 0.16 V, input impedance 47 kilohms

Outputs

Line outputs (phono jacks) rated output level 0.5 V at a load impedance of 47 kilohms, load impedance over 10 kilohms

Headphones (stereo phone jack) output level 0.25 mW at a load impedance of 32 ohms

General

Power requirements

U.S.A. and Canadian models:

120 V AC, 60Hz

British models: 220-230 V AC, 50/60Hz

Other European models: 230 V AC, 50/60Hz

Australian models: 240 V AC, 50/60Hz

Other models: 120/220/230-240 V AC, 50/60Hz

Adjustable with voltage selector

Power consumption

TC-WE675: 22 watts

TC-WE475: 18 watts

Dimensions (w/h/d) Approx. 430 x 120 x 300 mm

Mass 4.2 kg

Supplied accessories

Audio connecting cords (2)

Control AIII cable (1)*

* Supplied for Canadian models only

Optional accessory

Remote commander RM-J910

For more information on the availability of the remote commander, contact your nearest Sony dealer.

Design and specifications are subject to change without notice.

