

SANYO

INSTRUCTION MANUAL

VPC-S60EX
VPC-S60

Digital Camera

Xacti

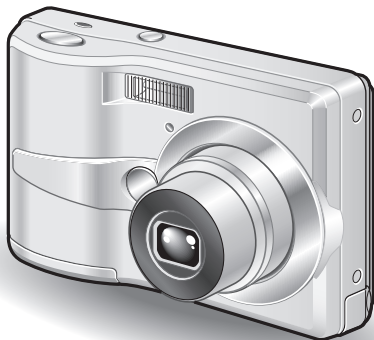

Important note

This manual explains how to safely operate the VPC-S60EX and VPC-S60.
Any information regarding only one of these products will be labeled as such.

Please read these instructions carefully before using the camera.
Make sure to read and understand the separate booklet "SAFETY MANUAL".
Keep this manual in a safe place for later reference.

Warning

TO PREVENT THE RISK OF FIRE OR ELECTRIC SHOCK, DO NOT EXPOSE THIS APPLIANCE TO RAIN OR MOISTURE

■ FOR AMERICAN USERS

The following advisory is included in accordance with the laws of the State of California (USA):

WARNING:

This product contains chemicals, including lead, known to the State of California to cause cancer, birth defects or other reproductive harm. **Wash hands after handling.**

- This equipment has been tested and found to comply with the limits for a Class B digital device, pursuant to Part 15 of the FCC Rules. These limits are designed to provide reasonable protection against harmful interference in a residential installation. This equipment generates, uses and can radiate radio frequency energy and, if not installed and used in accordance with the instructions, may cause harmful interference to radio communications. However, there is no guarantee that interference will not occur in a particular installation. If this equipment does cause harmful interference to radio or television reception, which can be determined by turning the equipment off and on, the user is encouraged to try to correct the interference by one or more of the following measures:
 - Reorient or relocate the receiving antenna.
 - Increase the separation between the equipment and receiver.
 - Connect the equipment into an outlet on a circuit different from that to which the receiver is connected.
 - Consult the dealer or an experienced radio/TV technician for help.
- Changes or modifications not expressly approved by the party responsible for compliance could void the user's authority to operate the equipment.

Declaration of Conformity

Model number: VPC-S60

Trade Name: SANYO

Responsible party: SANYO FISHER COMPANY

Address: 21605 Plummer Street, Chatsworth, California 91311

Telephone No.: (818) 998-7322

This device complies with Part 15 of the FCC Rules. Operation is subject to the following two conditions:

- (1) this device may not cause harmful interference, and
- (2) this device must accept any interference received, including interference that may cause undesired operation.

■ FOR CANADIAN USERS

- This Class B digital apparatus complies with Canadian ICES-003.

■ FOR EU USERS



Note:

- This symbol mark and recycle system apply only to EU countries and do not apply to countries in other areas of the world.

Your SANYO product is designed and manufactured with high quality materials and components which can be recycled and reused.

This symbol means that electrical and electronic equipment, at their end-of-life, should be disposed of separately from your household waste.

Please dispose of this equipment at your local community waste collection/recycling centre.

In the European Union there are separate collection systems for used electrical and electronic products.

Please help us to conserve the environment we live in!

■ Symbols used in this manual

HINT Points giving some extended instructions or special points to pay attention to.

CAUTION Points that require special attention.

(page xx) Refer to the page indicated for detailed information.

You may find the answers to questions or problems concerning camera operation in the sections "COMMONLY ASKED QUESTIONS" (page 111) and "TROUBLESHOOTING" (page 117).

GETTING UP AND RUNNING

Install the battery

- 1** Open the battery/card cover, and insert the batteries.
- The battery/card cover is located on the bottom of the camera.

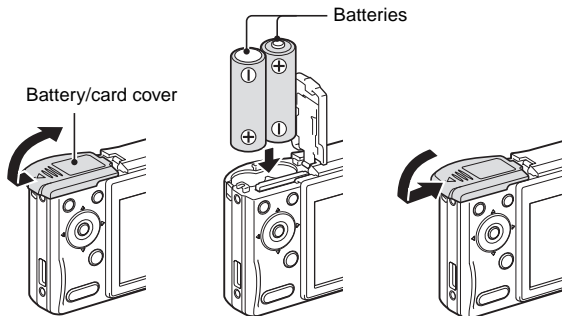

-
- 2** Press the ON/OFF button to turn the camera on.
- The Shooting Screen appears.

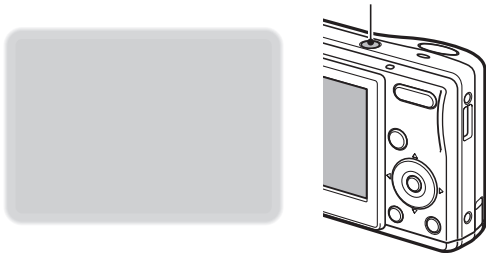



Shooting

■ Single shot (still image) photography

- 1 Press the [▶] button.**
 - The screen to set the shooting mode and self timer appears.

- 2 Press the [▶] button to select the single shot mode, and press the SET button.**
 - An icon in the upper left area of the monitor indicates the active shooting mode setting.

- : Single shot mode
- : Sequential shots mode
- : Video clip recording mode

- 3 Press the shutter button.**
 - The image is captured.

■ Video clip recording

- 1 Press the [▶] button to select the video clip recording mode.**

- 2 Press the shutter button.**
 - Recording begins.
 - To stop recording, press the shutter button again.

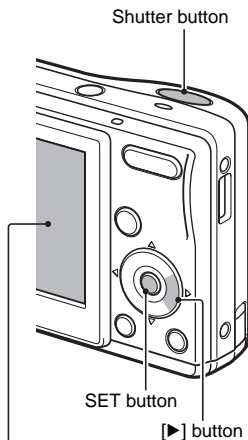

<Shooting mode>

Playback

■ Still image playback

1 Press the playback button [▶].

- The display switches to the Playback Screen.
- To view other images, press the [◀] or [▶] button.
- If the playback button [▶] is pressed, the display returns to the Shooting Screen.

■ Video clip playback

1 Press the playback button [▶].

- The display switches to the Playback Screen.
- Press the [◀] or [▶] button to display the video clip you wish to play back.
- Video clips are indicated by a video clip pattern along the top and bottom of the screen.

2 Press the SET button.

- Playback of the selected video clip begins.
- If the playback button [▶] is pressed again, the display changes to the Shooting Screen.

Playback button [▶]

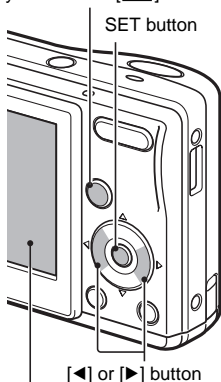

When you are finished taking pictures...

Press the ON/OFF button to turn the camera off.

QUICK SEARCH BY OPERATION

Your camera has an abundance of convenient features and functions. From creating precisely the photo you want, to viewing images using various techniques, you can locate the exact operation for your purposes in the following table.

	Basic operation	Convenient functions	Additional functions
Shooting/recording	Getting started shooting <ul style="list-style-type: none">• "Recording a video clip" on page 40• "Shooting single shots" on page 31• "SHOOTING SEQUENTIAL SHOTS" on page 39	Log the date and time of your photos <ul style="list-style-type: none">• "DATE AND TIME SETTING" on page 19 Zoom in on the subject <ul style="list-style-type: none">• "USING THE ZOOM" on page 47 Close-up photography <ul style="list-style-type: none">• "FOCUS RANGE" (macro mode) on page 52	For more accurate focus <ul style="list-style-type: none">• "FOCUS RANGE" (manual focus) on page 52 Set the focus to a narrow range <ul style="list-style-type: none">• "FOCUS AREA SETTING" on page 61 Check the focus status <ul style="list-style-type: none">• "Zoom jump playback" on page 36
	Optimize the photo quality <ul style="list-style-type: none">• "RESOLUTION/VIDEO CLIP SETTING" on page 58		
	Capture fast-moving subjects <ul style="list-style-type: none">• "USING THE SCENE FUNCTION" (sports mode) on page 44		

	Basic operation	Convenient functions	Additional functions	
Shooting/recording	Shoot in dark conditions <ul style="list-style-type: none"> • "EXPOSURE CORRECTION" on page 65 • "FLASH SETTING" on page 48 • "USING THE SCENE FUNCTION" (night view mode) on page 44 			
			Increase the camera's sensitivity "ISO SENSITIVITY" on page 62	
	Photographing people <ul style="list-style-type: none"> • "USING THE SCENE FUNCTION" (cosmetic mode/portrait mode/night view mode) on page 44 • "FLASH SETTING" (red-eye reduction) on page 48 			
	Photographing landscapes <ul style="list-style-type: none"> • "USING THE SCENE FUNCTION" (landscape mode) on page 44 			
	Take a self-photo <ul style="list-style-type: none"> • "SELF-TIMER" on page 50 			
			Make images lighter or darker <ul style="list-style-type: none"> • "EXPOSURE CORRECTION" on page 65 	Adjust the camera's sensitivity <ul style="list-style-type: none"> • "ISO SENSITIVITY" on page 62
			Change the color of the images <ul style="list-style-type: none"> • "USING THE SCENE FUNCTION" (monochrome/sepia) on page 44 	Make white appear natural <ul style="list-style-type: none"> • "WHITE BALANCE" on page 63

	Basic operation	Convenient functions	Additional functions
Playback	Getting started viewing images <ul style="list-style-type: none"> • “Playing back the video clip” on page 41 		
	<ul style="list-style-type: none"> • “Viewing still images” on page 33 	Search for image data <ul style="list-style-type: none"> • “9-image display playback” on page 34 Magnify an image <ul style="list-style-type: none"> • “Magnifying (zooming in) the image” on page 35 	Check the focus status <ul style="list-style-type: none"> • “Zoom jump playback” on page 36 Change the angle of view <ul style="list-style-type: none"> • “ROTATE IMAGE” on page 70
	Slideshow playback <ul style="list-style-type: none"> • “SLIDESHOW PLAYBACK” on page 80 		
	Adjust the monitor brightness <ul style="list-style-type: none"> • “Adjust the monitor brightness” on page 29 		
Data managing/processing	Search for image data <ul style="list-style-type: none"> • “9-image display playback” on page 34 		
	Delete files <ul style="list-style-type: none"> • “Erasing files” on page 37 	Protect images from accidental erasure <ul style="list-style-type: none"> • “IMAGE PROTECT” on page 68 Format a card <ul style="list-style-type: none"> • “INITIALIZING THE CARD MEMORY AND INTERNAL MEMORY” on page 95 	
	Specify the number of prints and date imprint <ul style="list-style-type: none"> • “PRINT SETTINGS” on page 74 		
	View the settings that were in effect when the image/audio data was recorded <ul style="list-style-type: none"> • “DISPLAYING IMAGE PROPERTIES (INFORMATION SCREEN)” on page 81 		

CONTENTS

QUICK SEARCH BY OPERATION	1
CONTENTS	4
CHECKING THE INCLUDED ACCESSORIES	7
GETTING THE MOST OUT OF YOUR CAMERA	9
SYSTEM MAP	11

■ SETUP

PARTS NAMES	12
INSTALLING THE BATTERIES AND CARD	14
TURNING THE CAMERA ON AND OFF	17
DATE AND TIME SETTING	19

■ BASIC OPERATION

BEFORE TAKING PICTURES	22
CAPTURING AND PLAYING BACK STILL IMAGES	31
SHOOTING SEQUENTIAL SHOTS	39
VIDEO CLIP RECORDING AND PLAYBACK	40

CONTENTS

■ **PLAYBACK**

DISPLAYING THE PLAYBACK MENU	66
IMAGE PROTECT	68
ROTATE IMAGE	70
CHANGING IMAGE SIZE (RESIZE)	71
COPY DATA	72
PRINT SETTINGS	74
SLIDESHOW PLAYBACK	80
DISPLAYING IMAGE PROPERTIES (INFORMATION SCREEN)	81

■ **OPTION**

DISPLAYING THE OPTION MENU	82
SOUNDS	85
POST-VIEW SETTING	87
SCREEN LANGUAGE	88
TV SYSTEM SETTING	89
AUTO POWER OFF FUNCTION	90
FILE No. RESET FUNCTION	92
INITIALIZING THE CARD MEMORY AND INTERNAL MEMORY	95
RESETTING THE CAMERA SETTINGS	97
CHECKING THE REMAINING INTERNAL MEMORY AND CARD MEMORY	98
CHECKING THE REMAINING BATTERY CHARGE	100

■ OTHER DEVICES AND CONNECTIONS

CONNECTING TO A TV	102
DIRECT PRINTING	103

■ APPENDICES

COMMONLY ASKED QUESTIONS	111
TROUBLESHOOTING	117
SPECIFICATIONS	123
HINTS FOR TAKING PICTURES	130

CHECKING THE INCLUDED ACCESSORIES

- Handstrap: 1



- SANYO Software Pack (CD-ROM): 1



- AA alkaline batteries: 2 (batteries made exclusively to be used as included accessories)

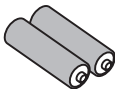

- Dedicated AV interface cable: 1

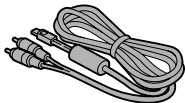

- Dedicated USB interface cable: 1

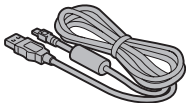

- "SAFETY MANUAL" (safety precautions booklet)
Please read this booklet carefully before using the digital camera.



- Quick Guide



Attaching the handstrap

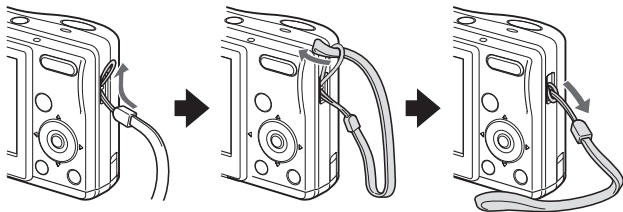

Media cards that can be used with this camera

The types of card that can be inserted into and used with this camera are:

- SD Memory Card
- Multi Media Card

What “card” means in this manual

- In this manual, SD Memory Cards and Multi Media Cards that can be used in this digital camera are referred to as “card”.
- The cards in the illustrations in this manual are SD Memory Cards, but all installation, removal, and formatting procedures are the same for both SD Memory Cards and Multi Media Cards.

GETTING THE MOST OUT OF YOUR CAMERA

It's loaded with lots of functions that are possible only in a digital camera, including a super-quick focus, an easy-to-understand guidance display on a large screen, a more extensive scene function, and more.

You'll never miss a photo opportunity, thanks to the quick focus: Touch focus (see page 57)

Just touch the shutter button lightly, and the touch sensor automatically focuses the image (touch focus).

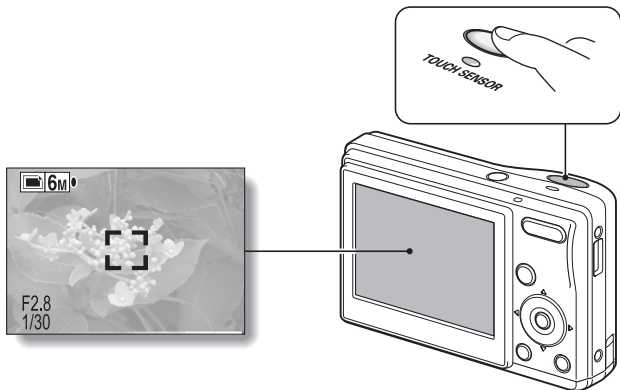

■ Abundant scene functions

You can select from a variety of preset settings (aperture, shutter speed, etc.) for specific shooting conditions.

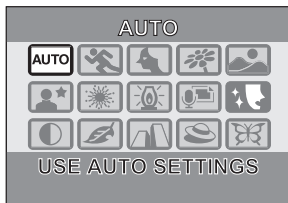

■ Speedy mode-switching

Switch the shooting mode from still images to video clips to sequential shots with a single button operation.



SYSTEM MAP

The included accessories can be used to connect your camera to a computer, printer or TV. By connecting the camera to your computer, you can, for example, copy your photos to the computer's hard disk. You can connect it to a printer for direct printing of your photos. Or take the card to a photo shop to have your photos printed there.

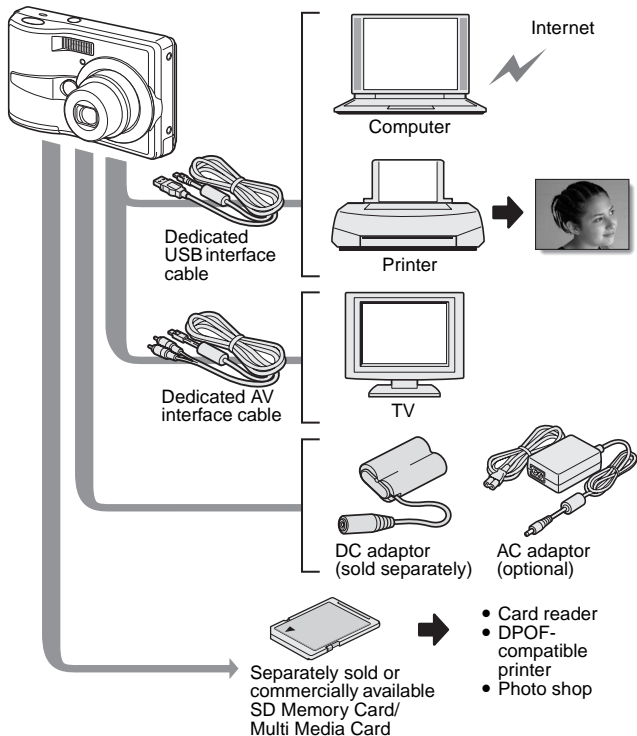

PARTS NAMES

Front

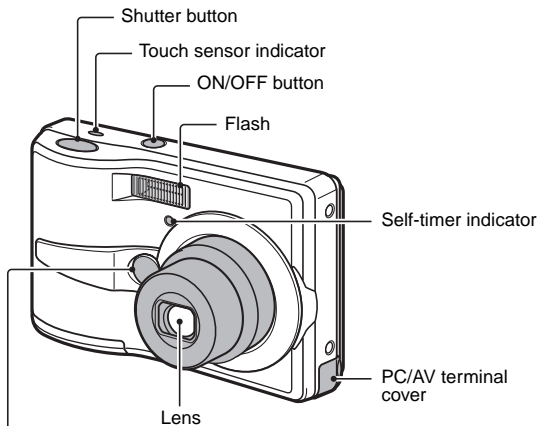

Mirror: Check the camera angle when taking a picture of yourself.

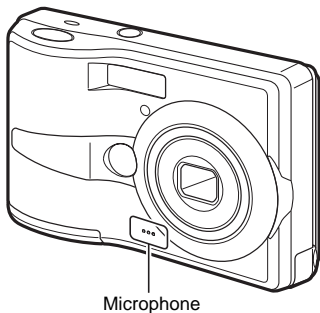

PARTS NAMES

Rear

Illumination sensor

- Detects the ambient brightness and automatically adjusts the brightness of the monitor accordingly.

Zoom switch [W]/[T]

Strap holder

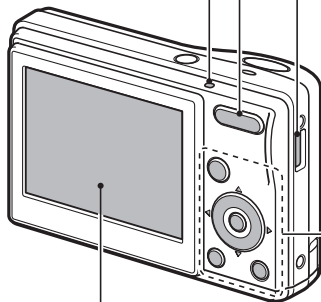

Monitor

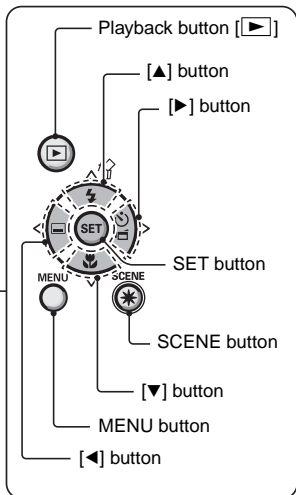

Playback button [▶]

[▲] button

[▶] button

SET button

SCENE button

[▼] button

MENU button

[◀] button

Bottom

Battery/card cover

Tripod stand hole

Speaker

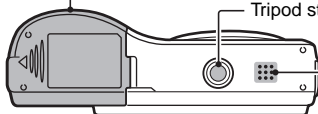

INSTALLING THE BATTERIES AND CARD

Your camera has an internal memory, which means that you can take photos even when no card is installed. By using a card, however, you will be able to take many more photos.

The card can be used after it has been formatted with the camera (page 95).

- 1** Open the battery/card cover.
- While gently pressing the battery/card cover, slide it open.

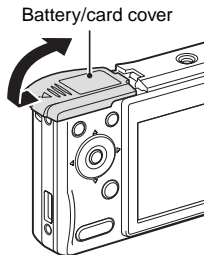

- 2** Insert the batteries.
- Make sure that the batteries' polarities (+ and -) are correct.

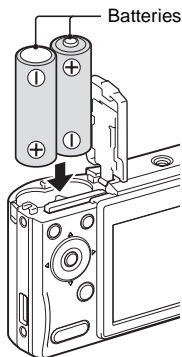

INSTALLING THE BATTERIES AND CARD

3 Insert the card.

- Firmly insert the card until it clicks into place.

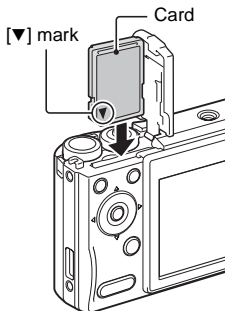

4 Close the battery/card cover.

When removing the card...

- To remove the card, press it down, and then release. The card will protrude slightly, and you can then pull it out.

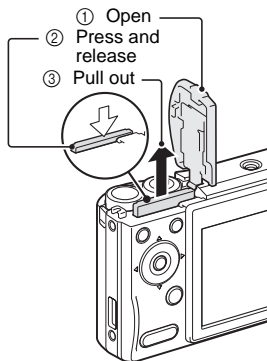

Keep your finger on the card until it is completely inserted or released.

- If you remove your finger too soon, the card may spring out and become lost or hit someone in the eye.

CAUTION

Be careful when removing the card.

- Do not attempt to forcibly remove the card.
- Never remove the card when the camera is connected to a computer or printer, or when the self-timer indicator is flashing quickly. In doing so, you risk losing the data stored in the card.

Manganese batteries cannot be used.

- Not only do manganese batteries have a short battery life, but there is the danger of their overheating and causing damage to the digital camera.

Other batteries

- If you wish to use batteries other than the alkaline batteries (LR6), we recommend the following.
 - AA-size nickel metal hydride (NiMH) rechargeable batteries (SANYO HR-3UTG) × 2
 - AA-size Ni-Cd batteries (SANYO N-3UV) × 2When installing the batteries, make sure that they are oriented correctly.

Do not open the battery/card cover when the camera is turned on.

- If the battery/card cover is opened while the power is on, important data may be lost. Sanyo Electric shall not be held responsible for any losses that result from failure to comply with this warning.

HINT

Shooting without a card installed

- When a card is installed, images are recorded to and played back from the card. When no card is installed, images are recorded to and played back from the camera's internal memory. When the camera is turned on with no card installed, the internal memory icon  is shown on the monitor to let you know that the images you capture will be saved to the camera's internal memory.

About the internal backup battery

- This camera's internal battery serves to maintain the date and time settings, as well as the shooting settings. The backup battery will be fully charged when the batteries are kept in the camera continuously for about 2 days. In the fully charged state, the backup battery will maintain the camera settings for about 7 days.

When not using the camera for a long time, remove the batteries.

- A small amount of power is still used even if the camera is turned off, and it is therefore recommended that the batteries be removed from the camera if it is not going to be used for a long time. Note that when the batteries are removed for a long period, the time and date settings may be cleared. Before using your camera again, be sure to confirm that the camera settings are correct.

TURNING THE CAMERA ON AND OFF

Turning on the camera

In the shooting mode

- 1 Press the **ON/OFF** button.
 - The camera turns on.
 - The camera turns on in the shooting mode that was active before it was last turned off.

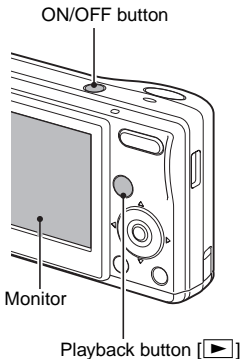

In the playback mode

- 1 Press the **playback button [▶]** for **at least one second**.
 - The Playback Screen appears on the monitor (pages 33 and 41).

Turning off the camera

- 1 Press the **ON/OFF** button.
 - The camera turns off.
 - <If the camera was turned on by pressing the playback button [▶]>
 - When the playback button [▶] or ON/OFF button is pressed, the camera turns off.

About the auto power off function

In order to preserve battery power when, for example, the camera has accidentally been left on, the camera is furnished with an “auto power off” function by which the camera automatically turns off after a certain period of inactivity (about 1 minute during shooting or about 3 minutes during playback [factory default settings]).

- If the auto power save function has operated to turn the camera off, press the ON/OFF button to turn it back on.
- You can change the setting for the time elapsed before the camera automatically turns off (page 90).
- When the camera is connected to a computer or printer using the dedicated USB connection cable, the auto power save function is disabled, and the camera turns off after about 12 hours.

HINT

If the icon appears...

- When a picture is taken, the date and time it was captured is recorded with it. When the date and time cannot be recorded with the image because the date and time have not yet been set (page 19), the  icon appears. To have the date and time recorded with images, please make this setting before capturing images.

DATE AND TIME SETTING

The camera will record the date and time an image is captured so that you can display them during playback. Therefore, before capturing images, make sure the correct date and time are set.

Example: To set the clock to 7:30 p.m. on December 24, 2006

- 1 Press the ON/OFF button to turn the camera on, and press the MENU button.**

- The Recording Menu appears (page 54).

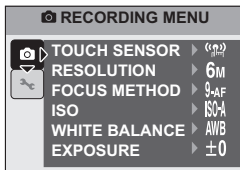

- 2 Press the [▼] button to select the [] tab.**

- The Option Menu appears.

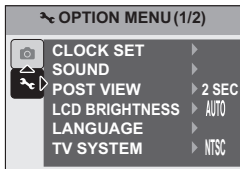

- 3 Press the [▶] button to select "CLOCK SET", and press the SET button or the [▶] button.**

- The Clock Set Screen appears.
- The current date and time settings are shown.
- Follow the procedures below to enable or disable the date display during playback, to set the display format for the date, and to set the date and time.
- To return to the Option Menu, press the MENU button.

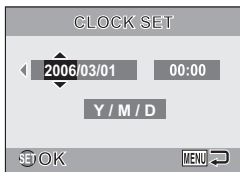

4 Set the date and time.

- ① Press the [▶] button to select the year indication.
- ② Press the [▲] or [▼] button to change the year indication.
 - Repeat these steps to select the month indication and day indication, and set the date to December 24, 2006.
- ③ Press the SET button or the [▶] button to select the time indication.
- ④ Press the [▲] or [▼] button to change the time setting.
- ⑤ Press the [▶] button to select the Y/M/D indication.
- ⑥ Press the [▲] or [▼] button to change the displayed date order.

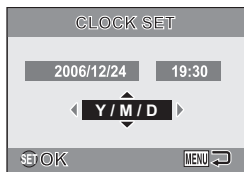
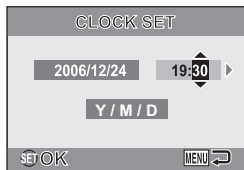
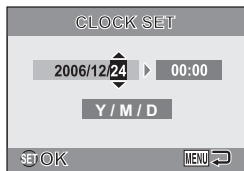

- Press the [▲] button to change the displayed date order as follows:
 → year/month/day → month/day/year → day/month/year _____
- Press the [▼] button to change it in the reverse order.

DATE AND TIME SETTING

5 Press the **SET** button.

- The date and time setting is completed, and you are returned to the Option Menu.
- The Option Menu is canceled when the MENU button is pressed.

HINT

- Under normal conditions, while the batteries are being replaced, an internal battery will maintain the date and time settings. However, there is a small chance the settings may be lost. (The backup will last for about 7 days.) It is recommended to check that the date and time settings are still correct after replacing the batteries and before shooting or recording of any type (follow steps **1** to **4**).

To correct the date and time settings

- In step **4**, select the indication that you want to change, and follow the procedure to change the indication.

BEFORE TAKING PICTURES

How to hold the camera

Hold the camera securely, keeping your elbows close to your body and making sure the camera is stable.

Correct hold



Incorrect hold



A finger is blocking the lens or flash.

Make sure that the lens and flash are not blocked by your fingers or the handstrap.

HINT

- Images captured in the still image shooting mode can be rotated when they are played back (page 70).
- When the optical zoom is used or when the autofocus is operating, the image may appear to waver, but this is not a malfunction.

BEFORE TAKING PICTURES

About the touch sensor (touch focus)

With the touch sensor, the image is focused simply by a light finger-touch on the shutter button (focus lock). With the subject in focus, just gently press the shutter button to take the picture for a perfectly focused image.

At the same time, the touch sensor is temporarily deactivated whenever the Recording Menu (page 54) is displayed, thereby facilitating operation of these screens.

Furthermore, you can also deactivate the touch sensor so that the autofocus operates only when you press the shutter button halfway (page 57).



Using the autofocus

The autofocus will work in almost all situations; however, there are certain conditions that may cause the autofocus function to not work properly. If the autofocus function is not working properly, set the focus range to capture images (page 52).

■ Conditions that may cause incorrect focus

The following examples are some of the situations where the autofocus function may not work.

- **Subjects with low contrast, very bright subjects at the center of the image or dark subjects or locations**

Use the focus-lock function to lock the focus on an object with contrast at the same distance as the desired subject.

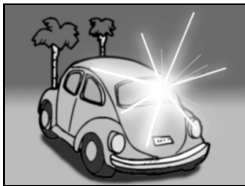

- **Subjects without vertical lines**

Use the focus-lock function to lock the focus while framing the subject vertically, then re-orient the camera to compose a horizontally framed image.

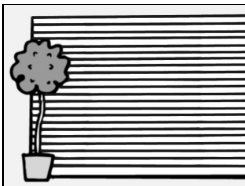

BEFORE TAKING PICTURES

The following examples are some of the situations where the autofocus function may work, but not as desired.

- **When both near and far objects are present**

Use the focus-lock function to lock the focus on an object at the same distance as the desired subject, then reposition the camera to compose the picture.



- **Fast-moving subjects**

Use the focus-lock function to lock the focus on an object at the same distance as the desired subject, then reposition the camera to compose the picture.



Switching between the shooting mode and playback mode

Switch between the shooting mode and the playback mode.

- 1 Press the **ON/OFF** button to turn the camera on.

- 2 Press the **playback button** [▶].
 - Each time the playback button is pressed, the camera switches between the shooting mode and the playback mode.

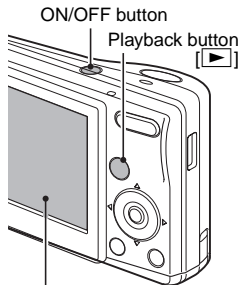

<Shooting mode>

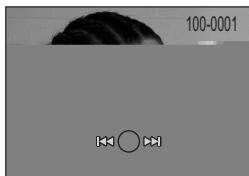

<Playback mode>

HINT

To turn the camera on in the playback mode

- Press the playback button [▶] for at least 1 second, and the camera will turn on in the playback mode.

BEFORE TAKING PICTURES

How to switch the shooting mode

Your camera can capture single still photos (single shot shooting mode), record video clips (video clip recording mode), and also capture a series of still photos (sequential shots shooting mode).

1 Press the **ON/OFF** button to turn the camera on.

2 Press the **[▶]** button.

- The screen to set the shooting mode and the self timer appears.



3 Press the **[▶]** button to select the shooting mode.

4 Press the **SET** button.

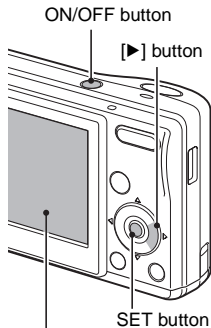
- The selected shooting mode is not set.
- An icon in the upper left area of the monitor indicates the active shooting mode setting.



<Shooting mode>

- :Single shot mode
- :Video clip recording mode
- :Sequential shots mode

Switching the display mode

In the shooting mode, you can select either the “settings display mode” which allows you to confirm the shooting settings on the monitor while you shoot, or the “normal display mode” in which the setting indications are turned off, providing a full view of the subject.

1 Press the ON/OFF button to turn the camera on.

2 Press the SET button.

- Each time the SET button is pressed, the camera switches between the settings display mode and the normal display mode.

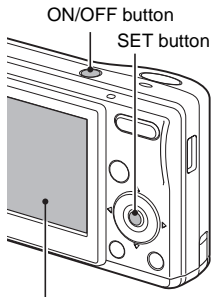

<Settings display mode>



<Normal display mode>

BEFORE TAKING PICTURES

Adjust the monitor brightness

The brightness of the monitor is adjustable. Adjust the brightness to the optimum readability in the ambient light.

- 1 Press the ON/OFF button to turn the camera on.**
- 2 Press the MENU button for at least 1 second.**
 - The Monitor Brightness Screen appears.
- 3 Press the [▲] and [▼] buttons to adjust the brightness.**
 - When set to AUTO, the illumination sensor (page 13) detects the ambient brightness and automatically adjusts the brightness of the monitor accordingly.
- 4 Press the SET button.**
 - The monitor brightness is set, and the Monitor Brightness Screen is canceled.

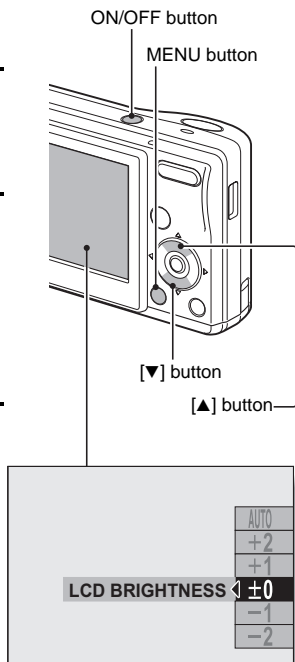

Hints for taking pictures

Muting the camera sounds

- The operation sounds that are generated, for example, when the shutter button, MENU button or SET button is pressed, can be muted (page 85).

Where is the image data saved?

- All the image and sound data is recorded in the camera's internal memory or on the card installed in the camera.
- When a card is installed in the camera, the data is recorded on the card. If no card is installed, the data is recorded in the camera's internal memory.

Taking pictures in backlight conditions...

- When taking pictures with the light coming from behind the subject, due to the characteristics of the CCD, light lines or ghost patterns (flare phenomenon) may appear in the captured image. In this situation, it is recommended that you avoid taking pictures with the subject lit from behind.

Switching the guidance display ON/OFF

- Press the [◀] button. Each time the [◀] button is pressed, the guidance display switches between ON and OFF.

CAPTURING AND PLAYING BACK STILL IMAGES

There are two modes for capturing still images. In the normal still image mode, one image is captured each time the shutter button is pressed. In the sequential shots mode, when you press the shutter button, several successive images are captured. For more information about taking sequential shots, please see page 39.

Shooting single shots

1 Set the camera to the single shot mode (page 27).

2 Rest your finger on the shutter button.

- If the touch sensor (page 57) has been set to ON, when the shutter button is touched, the touch sensor indicator lights, the autofocus operates and the image is focused (focus lock).

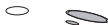

<If the touch sensor is set to OFF>

- Engage the autofocus by pressing the shutter button halfway.

3 Gently press the shutter button.

- Press the shutter button gently, taking care not to move the camera.
- The image that was captured appears on the monitor as long as the shutter button is kept pressed (post view).

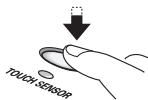

4 Release your finger from the shutter button.

- The captured image is recorded.

HINT

What is the camera focusing on?

- A target mark  on the monitor shows the area the camera is focusing on.
- The camera automatically determines the correct focus by measuring from 9 different focus points within the shooting area. If the target mark is at a position that is different from the point you wish to focus on, you can refocus, for example, by changing the shooting angle.
- The large target mark appears when the camera focuses on a wide area in the center of the screen.

About the focus indicator

- A green focus indicator appears when the subject is successfully focused, or a red focus indicator when the camera was not able to focus the subject.

The shutter speed and aperture are displayed

- When the camera focuses and the target mark appears, at the same time, the shutter speed and aperture settings are also displayed. You can use them as a reference when shooting.

If the motion alert icon appears...

- During still image shooting, if the shutter speed is slow and the possibility that the image may be blurred due to camera shake becomes high, the motion alert icon may appear on the monitor. In this case, use a tripod to stabilize the camera when shooting, or set the flash operation mode to automatic (page 48).
- When shooting with the scene function set to the fireworks  mode, the motion alert icon always appears, but this is normal.

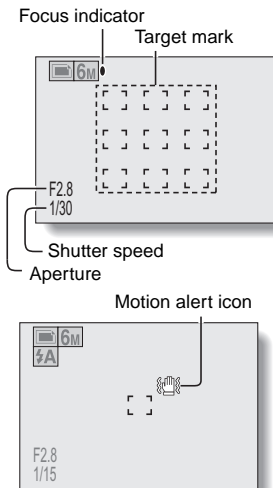

CAPTURING AND PLAYING BACK STILL IMAGES

Viewing still images

The steps for viewing both single shots and sequential shots are the same.

5 Press the playback button [▶].

- If the playback button [▶] was pressed to turn the camera on, however, press the playback button [▶] for at least 1 second.
- The image most recently captured appears on the monitor.

6 View other images.

- Press the [◀] or [▶] button to display the previous or next image.
To display the previous image:
Press [◀].
To display the next image:
Press [▶].
- To return to Shooting Screen, press the playback button [▶].

<If the camera was

by pressing

by pressing

es.

off.

voice memo (page 46)...

When the playback button is pressed, the voice memo is played back.

9-image display playback

- 1** Press the playback button [▶].

- 2** Press [W] ([⊞]) on the zoom switch.
 - The 9-image display appears.

- 3** Select the image to playback.
 - Press the arrow buttons to move the orange frame to the desired image, and press the SET button. Instead of pressing the SET button, you can press [T] ([🔍]) on the zoom switch to show the image full screen.

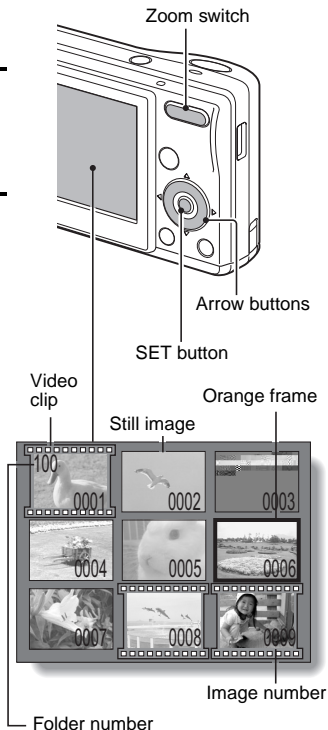

CAPTURING AND PLAYING BACK STILL IMAGES

Magnifying (zooming in) the image

1 Display the image that you want to magnify.

2 Press [T] ([🔍]) on the zoom switch.

- Magnification is enabled.
- The image is magnified, and the central portion of image is displayed.
- Press the arrow buttons to view different parts of the magnified image.

To magnify:

Magnification increases with each press of [T] ([🔍]) on the zoom switch.

To return to normal size:

Magnification decreases with each press of [W] ([🔍]) on the zoom switch.

- Press the SET button to return to the normal (100%) view.



HINT

The magnified portion of the image can be saved as a separate image.

- Press the shutter button. The magnified portion is saved as a new still image.

Zoom jump playback

You can magnify a portion of a still image to check the accuracy of the focus.

1 Display a still image to view using zoom jump playback.

2 Press the SET button.

- The image is magnified.
- If the magnified view appears to be in focus, then the

CAPTURING AND PLAYING BACK STILL IMAGES

Erasing files

You can erase files that are stored on the card if you no longer need them. You can erase the files one at a time, or all at once.

- 1** To erase data from the card, perform the delete procedure with the card installed in the camera. To erase data from the camera's internal memory, remove the card before performing the delete procedure.

- 2** Set the camera to the playback mode, and press the [▲] button.
 - The Delete Screen appears.

DELETE ALL:

Erases all the data.

DELETE SINGLE:

Erases one file at a time.

EXIT:

Returns to the Playback Menu.



- 3** Delete the files.

<To delete all the files>

- ① Use the [◀] and [▶] buttons to view the images and check if it is OK to delete all the files.
- ② Press the [▲] or [▼] button to select DELETE ALL.
- ③ Press the SET button.
 - The Delete Confirmation Screen appears. To erase the files, select "YES", and press the SET button. When the file delete is completed, "NO IMAGE" is shown.

<To delete one file>

- ① Use the [◀] and [▶] buttons to display the file you wish to delete.
- ② Press the [▲] or [▼] button to select DELETE SINGLE.
- ③ Press the SET button.
 - The currently displayed file is deleted.
 - To delete other files, repeat steps ① to ③.

CAUTION

About protected images

- Files that are protected from accidental erase cannot be erased. To erase protected files, set the protect setting for the file to off (page 68), and then follow the file delete procedure.

SHOOTING SEQUENTIAL SHOTS

When the shutter button is pressed, still images are captured in succession.

1 Set the camera to the sequential shots mode (page 27).

- If the resolution is set to **10M**, the setting changes automatically to **6M**.

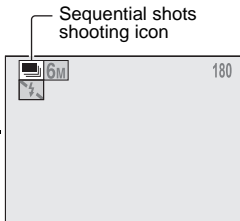

2 Press the shutter button to start shooting.

- Sequential shots shooting begins.



<Estimated maximum number of sequential shots>

Resolution	Max. no. of shots
6M	Approx. 4 shots
4M	Approx. 6 shots
2M	Approx. 12 shots
0.3M	Approx. 79 shots

- * The maximum number of sequential shots will differ depending on the subject.
- Note that if the shutter button is released during shooting, shooting stops immediately.

HINT

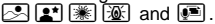
Limitations of sequential shots settings

- It is not possible to set the resolution to **10M**.
- The following scene functions cannot be set:  and .
- Flash photography is not possible.

VIDEO CLIP RECORDING AND PLAYBACK

Recording a video clip

1 Set the camera to the video clip recording mode (page 27).

2 Press the shutter button.

- Video clip recording begins. During recording, the recording time is shown on the monitor.
- It is not necessary to continue pressing the shutter button while shooting.

3 End the recording.

- Press the shutter button again to stop recording and save the video clip.

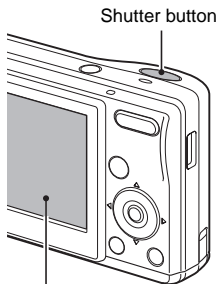

Video clip shooting icon

VIDEO CLIP RECORDING AND PLAYBACK

Playing back the video clip

4 Press the playback button [▶].

- If the playback button [▶] was pressed to turn the camera on, however, press the playback button [▶] for at least 1 second.
- The video clip just recorded appears on the monitor.
- Video clips are indicated by a video clip pattern along the top and bottom of the screen.

5 Press the SET button.

- Video clip playback begins.
- To stop playback, press the [▼] button.

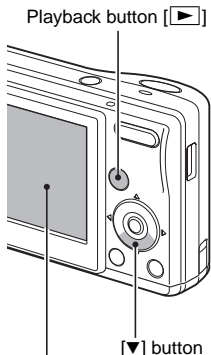

Video clip pattern

Outline of playback operation

To do this...		Do this
Stop playback		During playback, press the [▼] button
Pause		During playback, press the SET button. During accelerated playback, press the [▲] button.
To extract a still image		While playback is paused, press the shutter button.
To play back one image at a time (single-frame step)	During forward playback	While playback is paused, press the [▶] button.
	During reverse playback	While playback is paused, press the [◀] button.
Slow playback	During forward playback	While playback is paused, press and hold the [▶] button.
	During reverse playback	While playback is paused, press and hold the [◀] button.
To accelerate playback	Forward playback	During forward playback, press the [▶] button. * The playback speed changes each time the [▶] button is pressed, as follows: Normal playback → 2x → 5x → 10x → 15x Press the [◀] button to resume normal playback speed.
	Reverse playback	During forward playback, press the [◀] button. * The playback speed changes each time the [◀] button is pressed, as follows: 15x ← 10x ← 5x Press the [▶] button to resume normal playback speed.
Return to normal playback speed		Press the SET button.
Adjusting the volume		Louder: During playback, press [T] on the zoom switch. Softer: During playback, press [W] on the zoom switch.

When you are finished viewing video clips...

- Press the ON/OFF button to turn the camera off.

CAUTION

If no audio is heard...

The audio is not played back when the video clip is played back in the frame-by-frame, fast playback or reverse playback mode.

VIDEO CLIP RECORDING AND PLAYBACK

CAUTION

The data for a video clip is very large.

- Therefore, be aware that if the video clip is uploaded to a computer to be played back, the computer may not be able to play back the video fast enough, making it appear jerky. (The video will always be displayed properly on the monitor.)

If video clip recording stops even when there is card memory remaining...

- Depending on the card you are using, recording may stop even if there is remaining memory in the card.
- For video clip recording, it is recommended that a high-speed memory card be used.













USING THE SCENE FUNCTION

You can select from a variety of preset settings (aperture, shutter speed, etc.) for specific shooting conditions.

- 1** Set the camera to the shooting mode (page 26), and press the **SCENE** button.
 - The screen to select the settings suitable for the scene (shooting conditions) appears.
-

2

USING THE SCENE FUNCTION

Scene setting	Features	Shooting mode setting		
				
 Fireworks	For capturing fireworks at night.	<input type="radio"/>	<input checked="" type="radio"/>	<input type="radio"/>
 Lamp	Photograph in low-light conditions	<input type="radio"/>	<input checked="" type="radio"/>	<input type="radio"/>
 Still image with sound	Shoot a still image and add a voice memo.	<input type="radio"/>	<input checked="" type="radio"/>	<input checked="" type="radio"/>
 Cosmetic	Skin tones are enhanced in close-up shots.	<input type="radio"/>	<input type="radio"/>	<input type="radio"/>
 Monochrome	Create black-and-white photos.	<input type="radio"/>	<input type="radio"/>	<input type="radio"/>
 Sepia	Create sepia-tone photos.	<input type="radio"/>	<input type="radio"/>	<input type="radio"/>
 Sharpness	Accentuates the outlines in the image.	<input type="radio"/>	<input type="radio"/>	<input type="radio"/>
 Contrast	Accentuates the light and dark areas in the image.	<input type="radio"/>	<input type="radio"/>	<input type="radio"/>
 Vivid	Accentuates the colors in the image.	<input type="radio"/>	<input type="radio"/>	<input type="radio"/>

○: Available ×: Not available

3 Press the SET button.

- This completes the scene select setting.
- The display returns to the Shooting Screen.
- The scene function setting is shown on the monitor.

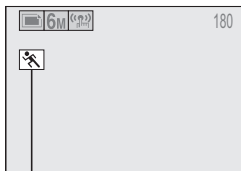

Scene function setting

Capture a still image with a voice memo

With the still-image-plus-audio  scene function, you can add an audio track (about 10 seconds maximum) to a captured still image. This audio track is called a “voice memo”.

1 On the screen to select the scene function settings (page 44), select , and press the SET button.

- 2** Press the shutter button to take the picture, then speak into the microphone.
- During recording, be careful not to obstruct the microphone with your fingers, for example.
 - The maximum recording time for a voice memo is about 10 seconds.
 - To end the recording before 10 seconds has elapsed, press the shutter button.

USING THE ZOOM

Your camera has two zoom functions: optical zoom and digital zoom.

1 Set the camera to the shooting mode (page 26), and point the camera lens at the subject.

2 Press the zoom switch to compose the desired image.

[T]: Zoom in on the subject.

[W]: Zoom out.

- When the zoom switch is pressed, the zoom bar appears on the monitor.
- When the optical zoom factor is at maximum, zooming stops temporarily. When [T] on the zoom switch is pressed again, the mode changes to the digital zoom mode and zooming continues.

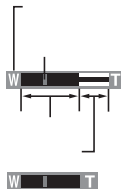
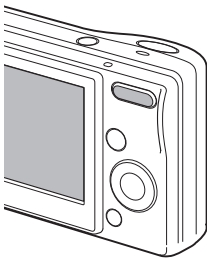

3 Take the picture.

HINT

Can't access the digital zoom?

- When the resolution is set to **10M**, the digital zoom is not available in the single-shot mode.

Can't access the optical zoom?

- During video clip recording, only the digital zoom is available, and the optical zoom cannot be used.

FLASH SETTING



The flash is used not only for taking pictures where there is insufficient light, but also when the subject is in shade or in backlight conditions. Your camera's flash has four modes of operation (automatic flash mode, forced flash mode, flash off mode and red-eye reduction mode). Select the flash mode that is appropriate for the surrounding conditions. The flash can be enabled only when taking single-shot still images.

1 Set the camera to the single-shot shooting mode (page 27), and press the [▲] ([⚡]) button.

- The flash setting changes.
- The flash setting appears on the monitor.
- The flash setting can also be changed from the Recording Menu (page 55).

No flash indication:

The camera will detect the subject brightness and use the flash only when required. In a backlight situation, if only the center of the image is very dark, the flash will operate to compensate (auto flash).

- : The flash will operate with every image captured regardless of the conditions. Use this setting under backlight conditions, when the subject is in shade, under fluorescent lighting conditions, etc. (forced flash).
- : The flash will not operate even in dark situations. Use this setting when capturing an image in a location where flash photography is prohibited, or when shooting a night landscape scene (flash off).
- : The digital camera will detect the subject brightness and use the flash only when required. At this time the flash will operate in a manner that reduces the red reflection ("red-eye") in the subject's eyes (red-eye reduction).

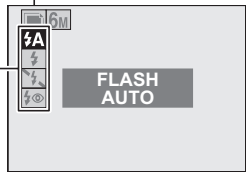
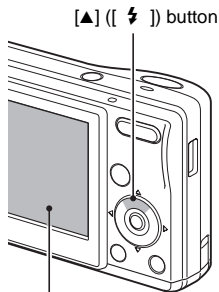

FLASH SETTING

2 Press the [▲] or [▼] button to select the desired flash mode, and press the SET button.

3 Press the shutter button.

- The picture is snapped and the flash operates according to the selected mode.

HINT

In the automatic flash mode...

- In the automatic flash mode, when the subject is in focus, a  icon appearing on the monitor indicates that the flash will operate.

de.

SELF-TIMER

HINT

To pause or cancel the self-timer function...

- If the shutter button is pressed again before the shutter is released, the self-timer countdown temporarily stops. Press the shutter button one more time to restart the self-timer.
- To cancel self-timer photography, set the self-timer setting to off .
- After the self-timer picture is snapped, the self-timer is automatically reset to off.

When is selected...

- When the shutter button is pressed, the self-timer indicator flashes for approximately 10 seconds, after which shooting begins.
- About 3 seconds before shooting, the self-timer indicator flashes faster.

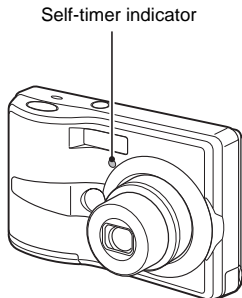

FOCUS RANGE

1 Set the camera to the shooting mode (page 26), and press the [▼] button.

- The screen to set the focus range appears.

: The camera automatically focuses on the subject within a range of 10 cm (3.94 in.) (Wide end) or 40 cm (15.75 in.) (Tele end) to infinity (autofocus).

: You can focus on a subject within a range of 5 cm (1.97 in.) (Wide end) or 40 cm (15.75 in.) (Tele end) to 70 cm (27.56 in.) (macro).

MF: The focus can be manually set to any distance from 5 cm (1.97 in.) to 8 m (26.25 ft), as well as to infinity (manual focus).

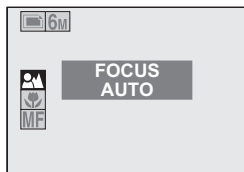

2 Press the [▲] or [▼] button to select the desired focus range, and press the SET button.

- The specified focus range is set, and the camera returns to the Shooting Screen.

HINT

- When the focus range is set to macro , the zoom is set to the wide end.

FOCUS RANGE

How to use the manual focus

- 1** Set the focus range to manual **[MF]** (page 52).
- 2** Press the **SET** button.
 - The focus distance adjustment bar appears.
- 3** Press the **[◀]** or **[▶]** button to adjust the focus distance, and press the **SET** button.
 - The focus distance is set, and you are returned to the Shooting Screen.

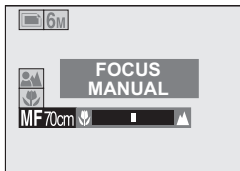

HINT

About the focus range

- The focus distance indication shows the distance between the lens surface and the subject.
- In some cases there may be a slight variance between the distance (numerical figure) you set in the manual focus mode and the actual distance. Use the monitor to confirm the focus and compose the photo.

About zoom movement when using the manual focus

- If the focus distance is set to 30 cm (11.81 in.) or less, the zoom changes to the largest setting that is suitable for that focus distance.
- When the focus distance is set to 30 cm (11.81 in.) or less, the zoom will function only within the range at which the image is focused.

ACCESSING THE RECORDING MENU

Detailed shooting settings are accessed from the Recording Menu.

1 Set the camera to a shooting mode (page 27).

2 Press the MENU button.

- The Recording Menu corresponding to the shooting mode set in step 1 appears.
- The Recording Menu can be canceled by pressing the MENU button.

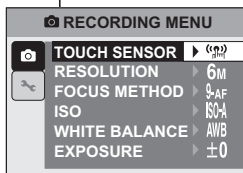
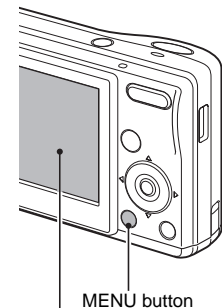

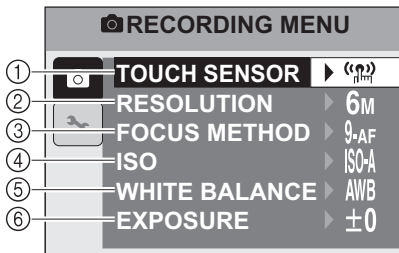

ACCESSING THE RECORDING MENU

Overview of the Recording Menu



① **Touch sensor menu (page 57)**

: Set the shutter button touch sensor to ON.

: Set the shutter button touch sensor to OFF.

② **Resolution menu/video clip mode menu (page 58)**

<Single-shot/sequential shots shooting mode>

: Shoot at 3,680 × 2,760 pixels (single-shot shooting mode only)

: Shoot at 2,816 × 2,112 pixels

: Shoot at 2,288 × 1,712 pixels

: Shoot at 1,600 × 1,200 pixels

: Shoot at 640 × 480 pixels

<Video clip recording mode>

: Shoot at 320 × 240 pixels

: Shoot at 640 × 480 pixels

: Make an audio recording (page 59)

③ **Focus mode menu (page 61)**

: 9-point focus mode

: Spot focus mode

④ **ISO sensitivity menu (page 62)**

: Sets the ISO sensitivity automatically (corresponds to ISO50 to 200).

: Corresponds to ISO50

: Corresponds to ISO100

: Corresponds to ISO200

: Corresponds to ISO400

⑤ **White balance menu (page 63)**

: The camera will determine the setting automatically.

: For photography in fair weather (sunny) conditions

: In overcast conditions

: Under fluorescent lighting

: Under incandescent lighting

: For setting the most accurate white balance

⑥ **Exposure correction icon (page 65)**

- Change the brightness of the image.

- When you specify multiple functions that cannot be simultaneously enabled, the function which was last set becomes the active setting, and the other settings accordingly change automatically.

TOUCH SENSOR (TOUCH FOCUS) SETTING

The touch sensor function, by which the autofocus is activated by a finger-touch on the shutter button, can be set to ON or OFF. When the touch sensor function is set to OFF, the autofocus is activated when you press the shutter button halfway; then gently press the shutter button to snap the picture.

1 Display the Recording Menu (page 54).

2 Select “TOUCH SENSOR” and press the SET button.

- The sensor menu appears.

3 Select the desired icon, and press the SET button.

- The selected touch sensor function is set.

CAUTION

- When the camera is attached to a tripod, the touch sensor sensibility may be diminished. This happens because the touch sensor works by detecting changes in the capacitance when the camera is touched with bare hands.

RESOLUTION/VIDEO CLIP SETTING

By setting the image resolution (pixels) to a higher setting, image detail is enhanced for a smoother, finer picture. However, the file size also becomes large and uses more memory. Select the resolution setting that suits your purpose.

1 Display the Recording Menu (page 54).

2 In the single shot or sequential shots shooting mode select [RESOLUTION], or in the video clip recording mode select [VIDEO CLIP MODE], and press the SET button.

- The resolution menu or video clip mode menu appears.

<Single shot/sequential shots shooting mode>

- 10M**: Shoot image at 3,680 × 2,760 pixels (Single shot mode only)
- 6M**: Shoot image at 2,816 × 2,112 pixels
- 4M**: Shoot image at 2,288 × 1,712 pixels
- 2M**: Shoot image at 1,600 × 1,200 pixels
- 0.3M**: Shoot image at 640 × 480 pixels

<Video clip recording mode>

- WEB**: Shoot at 320 × 240 pixels.
- TV**: Shoot at 640 × 480 pixels.
- 🎤**: Make an audio recording (page 59)

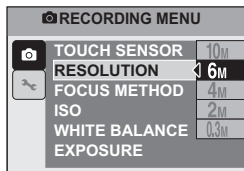

<Example: Single shot shooting mode>

3 Select the desired icon, and press the SET button.

- The selected resolution setting or video clip mode setting is set.

RESOLUTION/VIDEO CLIP SETTING

Record and play back an audio file

In the video clip recording mode, your camera can make audio recordings.

■ Record an audio file

- 1** Display **PAGE 1** of the Recording Menu for the video clip recording mode (page 54).

- 2** Select the audio recording icon  from the video clip mode menu, and press the **SET** button.

- 3** Press the **MENU** button.
 - The recording mode is enabled.

- 4** Press the shutter button.
 - Audio recording begins. It is not necessary to continue pressing the shutter button while recording.
 - Take care not to cover the microphone with your fingers.

- 5** End the recording.
 - Press the shutter button again to stop recording.

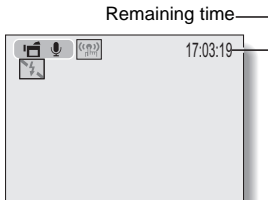

■ Playing back audio recordings

Listen to your audio recordings.

1 Display the desired audio data.

- A musical note graphic appears on the screen.

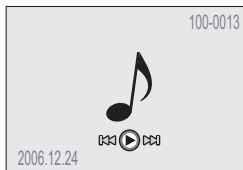

2 Play back the recording.

To do this...	Do this
Forward playback	Press the SET button.
Stop playback	During playback, press the [▼] button
Pause	During playback, press the SET button. During fast forward or fast reverse, press the [▲] button.
Fast forward	During forward playback, press the [▶] button. * The speed changes each time the [▶] button is pressed, as follows: Normal playback → 2x → 5x → 10x → 15x Press the [◀] button to resume normal speed.
Fast reverse	During forward playback, press the [◀] button. * The speed changes each time the [◀] button is pressed, as follows: 15x ← 10x ← 5x Press the [▶] button to resume normal speed.
Return to normal playback speed	Press the SET button.
Adjusting the volume	Louder: During playback, press [T] on the zoom switch. Softer: During playback, press [W] on the zoom switch.

FOCUS AREA SETTING

You can choose from the following 2 types of autofocus (still image shooting only):

9-point range finder focus: The correct focus is determined from 9 different focus points within the shooting area visible on the monitor. When the image is focused, a target mark  appears.

Spot focus: The camera focuses on the subject in the center of the monitor.

1 Display the Recording Menu (page 54).

ISO SENSITIVITY

With the initial settings, the ISO sensitivity is automatically set according to the brightness of the subject. However, the ISO sensitivity can be set to a fixed setting.

1 Display the Recording Menu (page 54).

2 Select "ISO" and press the SET button.

- The ISO sensitivity menu appears.

ISO-A: Sets the ISO sensitivity automatically (equivalent to ISO50 to 200 [video clip recording mode: ISO200 to 800]).

50: Sets the sensitivity to ISO50 equivalent (video clip recording mode: ISO200).

100: Sets the sensitivity to ISO100 equivalent (video clip recording mode: ISO400).

200: Sets the sensitivity to ISO200 equivalent (video clip recording mode: ISO800).

400: Sets the sensitivity to ISO400 equivalent (video clip recording mode: ISO1,600).

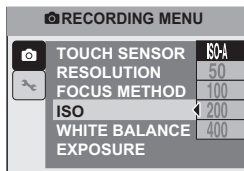

3 Select the desired icon, and press the SET button.

- The ISO sensitivity is set.

HINT

- By setting a higher ISO sensitivity, you can set higher shutter speeds and capture images in darker locations, but noise in the captured images may increase.

WHITE BALANCE

This camera automatically adjusts the white balance under most lighting conditions. However, if you want to specify the lighting conditions or change the overall tone of the image, the white balance can be manually set.

1 Display the Recording Menu (page 54).

2 Select "WHITE BALANCE" and press the SET button.

- The white balance menu appears.

AWB: The camera will make the white balance adjustment automatically based on the natural and artificial light conditions. This is the setting used in the auto mode.

: For shooting outside on a sunny day.

: For shooting outside on a cloudy day.

: For shooting inside under fluorescent lighting.

: For shooting inside under incandescent lighting.





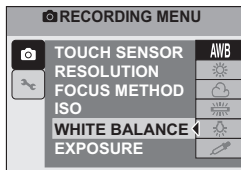

: For more accurate adjustment or when the light source cannot be specified (one-push).

Setting procedure

- Select the  icon, fill the entire screen with a plain white card (or piece of paper, etc.), and press the SET button.



3 Select the desired icon, and press the SET button.

- This completes the white balance setting.
- Once the white balance setting is programmed for the  icon, it is retained even if another white balance setting (AWB, , , , or ) is selected. If you changed to another setting, whenever you select the  icon and press the SET button, the previously programmed setting is recalled.

HINT

To cancel the white balance setting

- Perform step 1, select , and then press the SET button.

EXPOSURE CORRECTION

When capturing images, you can make the image lighter or darker.

- 1** Point the camera lens at the subject, and display the Recording Menu (page 54).
- 2** Press the [▶] and [▼] buttons to select "EXPOSURE" and press the SET button.
 - The screen to adjust the exposure appears.
- 3** Press the [▲] or [▼] button to select the exposure numerical value, and press the SET button.
 - The specified exposure is set, and you are returned to the Recording Menu.

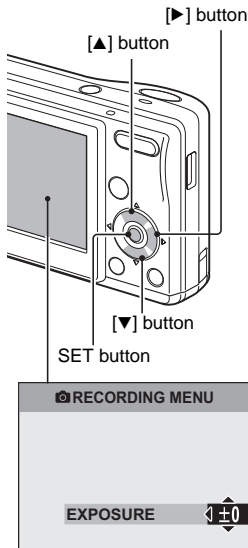

HINT

- The exposure correction setting returns to ± 0 after the camera is turned off.

DISPLAYING THE PLAYBACK MENU

The Playback Menu is used to adjust your camera's playback settings.

- 1 Press the playback button [▶].**
 - The display changes to the Playback Screen.

- 2 Press the MENU button.**
 - The Playback Menu appears.
 - The Playback Menu is canceled when the MENU button is pressed.

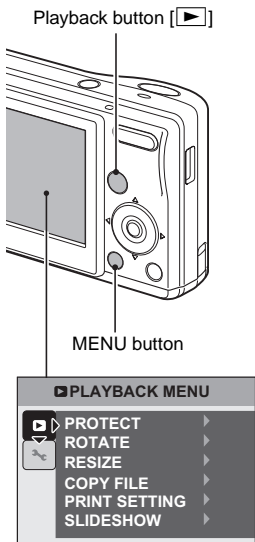

DISPLAYING THE PLAYBACK MENU

Overview of the Playback Menu



- ① **[Protect] (page 68)**
 - Protect data from accidental erasure (write protect).
- ② **[Rotate image] (page 70)**
 - Rotate still images.
- ③ **[Resize] (page 71)**
 - Reduce the resolution of a still image.
- ④ **[Copy file] (page 72)**
- ⑤ **[Print setting] (page 74)**
 - Specify the print settings.
- ⑥ **[Slideshow] (page 80)**
 - Play back the images in a slideshow format.

IMAGE PROTECT

Prevent accidental erasure of data.

- 1** Display the data that you want to protect from accidental erasure, and display the Playback Menu (page 66).

- 2** Select “PROTECT” and press the SET button.

- The screen to set the protect setting appears.

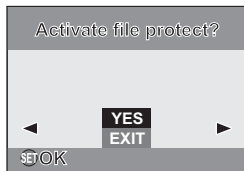

- 3** Select “YES” and press the SET button.

- The protect mode is set for the data.
- The protect mark  indicates that the data is locked.

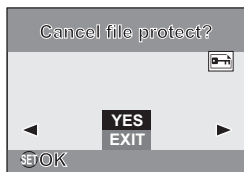

IMAGE PROTECT

CAUTION

- Even if the protect mode is set for certain data files, they will be erased if the card is reformatted (page 95).

HINT

To select a different image in steps 2 and 3...

- Press the [◀] or [▶] button.

To cancel the protect mode for an image...

- Display the desired data and repeat steps 1 to 3.

ROTATE IMAGE

Captured still images can be rotated to the correct orientation for viewing.

1 Display the image you wish to rotate, and display the Playback Menu (page 66).

2 Select “ROTATE” and press the SET button.

- The screen to rotate the image appears.
-

3 Select “YES” and press the SET button.

- Each time the SET button is pressed, the image is rotated another 90 degrees.
-

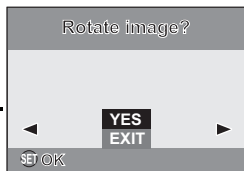

HINT

- On the 9-image display playback, rotated images are shown in their original orientation.
- An image for which the protect (locked) mode has been set cannot be rotated.

CHANGING IMAGE SIZE (RESIZE)

The size of a still image that has already been captured at a resolution of **2M** or more can be changed to 1,600 × 1,200 pixels or 640 × 480 pixels. The resized image is saved as a separate image.

1 Display the still image whose size you want to change, and display the Playback Menu (page 66).

2 Select “RESIZE” and press the SET button.

- The screen to change the still image resolution appears.



3 Select the new image size.

2M (1600 × 1200): The saved image will be 1,600 × 1,200 pixels.

0.3M (640 × 480): The saved image will be 640 × 480 pixels.

EXIT: Return to the Playback Menu.

4 Press the SET button.

- Resizing begins.
-

HINT

Why can't the image be resized?

- An image can be resized only to a smaller (or the same) size, not to a larger size.

COPY DATA

Images recorded in the camera's internal memory can be copied to the card, and likewise from the card to the internal memory.

1 Insert the card in the camera (page 14).

2 Display the Playback Menu (page 66).

3 Select "FILE COPY" and press the SET button.
• The screen to copy files appears.

4 Select the copy direction.

INT MEM ► CARD:

Copy image data from the internal memory to the card.

CARD ► INT MEM:

Copy image data from the card to the internal memory.

* If no card is set in the camera, you cannot copy data.



COPY DATA

5 Press the SET button.

- The screen to select the type of copy appears.
- The copy source is shown in the background on the screen.

COPY SINGLE:

Copy the data for one image.

COPY ALL:

Copy all the data from the copy source to the copy destination.

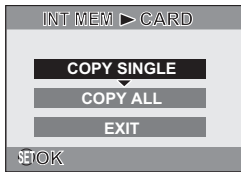

6 Select the desired type of copy.

<When selecting COPY SINGLE>

- ① Press the [◀] or [▶] button to display the image you wish to copy.
- ② Press the [▲] or [▼] button to select "COPY SINGLE".

<When selecting COPY ALL>

- ① Press the [▲] or [▼] button to select "COPY ALL".

7 Press the SET button.

- The files are copied.

PRINT SETTINGS

In addition to using your printer to print out still images captured with your camera, as with conventional film, you can have prints made at shops offering digital print services. Moreover, this camera is DPOF-compatible, so you can use the camera to specify the number of prints, whether or not the date is displayed on the print, and also to specify an index print.

Display the screen to set the print settings

1 Display the Playback Menu (page 66).

2 Select “PRINT SETTING” and press the SET button.

- The screen to set the print settings appears.

EACH IMAGE:

The print settings are specified for each individual image.

ALL IMAGES:

The specified print settings apply to all the still images on the card.

ALL CLEAR:

Clear all the print settings.



PRINT SETTINGS

HINT

About the DPOF format

- DPOF (Digital Print Order Format) is a print order format. You can connect your camera to a DPOF-compatible printer to produce your prints. You can also set the print settings (page 108) for the desired images, and then have the reserved images printed automatically.

About the finished prints

- Images that have been rotated will be printed in their original orientation.
- The quality of the print output will differ depending on the print service and printer used.

CAUTION

- It is not possible to set the print settings when there are 10,000 or more files saved on the card.

Specifying date imprinting and number of prints

You can specify print settings for each individual image (EACH IMAGE), or apply the print settings to all the images on the card (ALL IMAGES).

1 Display the screen to set the print settings (page 74).

2 Select EACH IMAGE or ALL IMAGES.

EACH IMAGE:

The set print settings are applied only to the image currently displayed.

ALL IMAGES:

The set print settings are applied to all the still images on the card.



3 Press the SET button.

- The Date/Copies Print Screen appears.
- If "EACH IMAGE" was selected, press the [◀] or [▶] button to display the desired image.
- The print settings for the displayed image appear in the upper right area. You can press the [SET] button to confirm the settings for the image.

PRINT SETTINGS

4 Specify the number of prints and whether the date is imprinted.

- Please specify the number of prints before setting the date imprint setting. The date imprint setting cannot be set until the number of prints has been entered.

<Specifying the number of prints>

- ① Press the [▲] or [▼] button to select "COPIES".
- ② Press the SET button.
 - The Print Number Screen appears.
- ③ Press the [▲] or [▼] button to specify the number of prints.
 - Press the [▲] or [▼] button until the desired number of prints is displayed.
- ④ Press the SET button.
 - You are returned to the Date/ Copies Print Screen.

<Specifying dated prints>

- ① Press the [▲] or [▼] button to select "DATE".
- ② Press the SET button.
 - The Print Date Screen appears.
- ③ Press the [▲] or [▼] button to select the desired option.

YES: Print the date.
NO: Do not print the date.
- ④ Press the SET button.
 - You are returned to the Date/ Copies Print Screen.

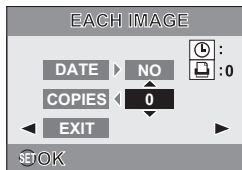

5 Select **EXIT**, and press the **SET** button.

- You are returned to the display in step 2.

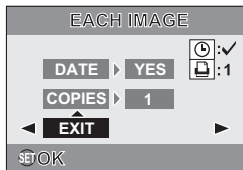

PRINT SETTINGS

Clearing all the print settings

Delete the print settings for all images.

1 Display the screen to set the print settings (page 74).

2 Select "ALL CLEAR".



3 Press the **SET** button.

- The Confirm All Clear Screen appears.

YES: Clear the print settings for all images.

NO: Cancel the clear procedure and return to the screen to set the print settings.

4 Select "YES", and press the **SET** button.

- All the print settings are cleared and you are returned to the screen to set the print settings.

SLIDESHOW PLAYBACK

1 Display the Playback Menu (page 66).

2 Select "SLIDESHOW" and press the SET button.

- The screen to set the slideshow appears.

TIME: Adjust the transition speed (the period that an image is displayed before it changes to the next image).

EFFECT: Select a transition effect as an image changes to the next image.

START: Begin slideshow playback.

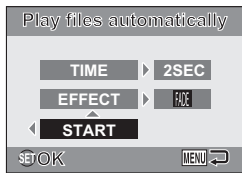

<Changing the transition speed or transition effect>

- ① Select "TIME" or "EFFECT", press the SET button.
- ② Press the [▲] or [▼] button to change the setting.
- ③ Press the SET button.

3 Select "START", and press the SET button.

- Slideshow playback starts.
- To stop slideshow playback, press the SET button or MENU button.

DISPLAYING IMAGE PROPERTIES (INFORMATION SCREEN)

On the Information Screen you can check what the settings were when an image was captured.

1 Display the desired image.

2 Press and hold the MENU button for at least 1 second.

- The Information Screen appears.
- If the MENU button is pressed again, the Information Screen is canceled.

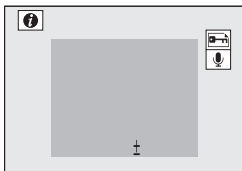

- ① Resolution setting
- ② Resolution
- ③ Scene function setting
- ④ Image number
- ⑤ Protect setting
- ⑥ Voice memo setting
- ⑦ File size
- ⑧ Aperture value
- ⑨ Shutter speed
- ⑩ Exposure correction setting
- ⑪ Video clip mode settings
- ⑫ Resolution and frame rate
- ⑬ File format
- ⑭ Playback time
- ⑮ Remaining battery power

DISPLAYING THE OPTION MENU

The Option Menu is used to adjust various camera settings.

1 Display the Recording Menu or Playback Menu.

- Recording Menu, see page 54
 - Playback Menu, see page 66
-

2 Press the [▲] or [▼] button to select the option tab .

- The Option Menu appears.

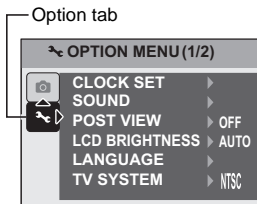

To exit the Option Menu

To return to the Shooting Screen or Playback Screen

→ Press the MENU button.

To return to the Recording Menu or the Playback Menu

→ With the option tab  selected, press the [▲] or [▼] button.

DISPLAYING THE OPTION MENU

Overview of the Option Menu

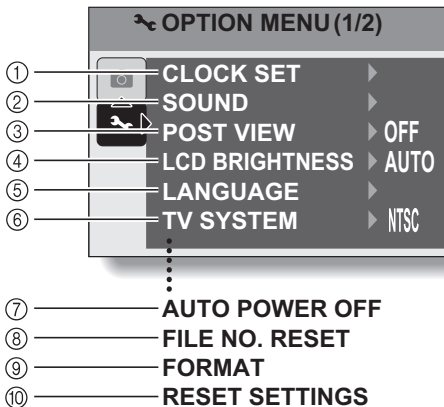

- ① **[Date and time setting] (page 19)**
 - Set the camera's internal clock.
- ② **[Sounds] (page 85)**
 - Adjust the sounds produced by the camera.
- ③ **[Post-view] (page 87)**
 - Specify how long a still image is displayed on the monitor after it is captured.
- ④ **[LCD brightness] (page 29)**
 - Adjust the brightness of the monitor.
- ⑤ **[Screen language] (page 88)**
 - Select the language in which the monitor messages are displayed.
- ⑥ **[TV system setting] (page 89)**
 - Select the type of TV signal that is output from the camera's PC/AV terminal.
- ⑦ **[Auto power off] (page 90)**
 - Specify the time elapsed before the auto power off function operates to turn the camera off.
- ⑧ **[File number reset] (page 92)**
 - Set the file number reset function to ON or OFF.
- ⑨ **[Format] (page 95)**
 - Reformat the camera's internal memory or the card installed in the camera.
- ⑩ **Reset camera settings (page 97)**
 - Reset the camera to the factory-preset settings.

- Icons ⑦ through ⑩ are displayed when you press the [▲] or [▼] button to scroll.

SOUNDS

Set the sounds (SOUNDS) that are produced by the camera.

1 Display the Option Menu (page 82).

2 Select “SOUNDS” and press the SET button.

- The screen to set the sounds appears.

OPERATION VOL:

Volume setting for all camera buttons.

TURN ON/OFF:

Mute or enable the sound that is produced when the camera is turned on or off.

SHUTTER:

Select the sound that is produced when the shutter button is pressed.

KEY SW:

Select the sound that is produced when a camera button (SET button, MENU button, etc.) is pressed.

AUDIO GUIDE:

Mute or enable the camera's audio help guide.

PLAY VOLUME:

Adjust the volume for playing back video clips and audio files.

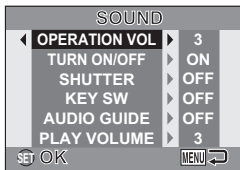

3 Select the desired item, and press the SET button.

4 Press the [▲] or [▼] button to change the setting.

<If “TURN ON/OFF” or “AUDIO GUIDE” is selected>

- The respective screen to enable or disable the sound appears.
ON: Activates the sound.
OFF: Deactivates the sound.

<If “SHUTTER” or “KEY SW” is selected>

- The respective screen to select the sound appears.
- Select from 5 different sounds (A to E) and “OFF”.
- After selecting a sound, press the [▶] button to preview it.
- If “OFF” is selected, no sound is produced.

<If “OPERATION VOL” or “PLAY VOLUME” is selected>

- The screen to select the volume setting appears.
- You can select a volume setting from 1 (minimum) to 5 (maximum).
- If “OFF” is selected, no sound is produced.

5 Press the SET button.

- The sound settings are completed.
- To return to the Option Menu, press the MENU button.

POST-VIEW SETTING

Specify the duration that the captured image appears on the monitor (post-view) after the shutter button is pressed.

1 Display the Option Menu (page 82).

2 Select "POST VIEW" and press the SET button.

- The Post View Menu appears.

1SEC:

The post-view image is displayed for 1 second.

2SEC:

The post-view image is displayed for 2 seconds.

OFF:

The post-view image is not displayed.

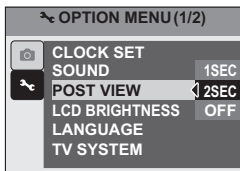

3 Select the desired setting, and press the SET button.

- This completes the post-view setting.

SCREEN LANGUAGE

You can set the monitor of your camera to display the messages in any one of several languages.

1 Display the Option Menu (page 82).

2 Select "LANGUAGE" and press the SET button.

- The screen to select the display language appears.

DEUTSCH:	German
ENGLISH:	English
ESPAÑOL:	Spanish
FRANCAIS:	French
ITALIANO:	Italian
NEDERLANDS:	Dutch
РУССКИЙ:	Russian
日本語:	Japanese
한국어:	Korean
中文(繁):	Chinese (traditional)
中文(简):	Chinese (simplified)



3 Select the desired language, and press the SET button.

- The selected display language is set.

TV SYSTEM SETTING

Specify the type of image signal that is output from your camera's PC/AV terminal.

1 Display the Option Menu (page 82).

2 Select "TV SYSTEM" and press the SET button.

- The TV System Menu appears.

NTSC:

Outputs NTSC video signals.

PAL:

Outputs PAL video signals.

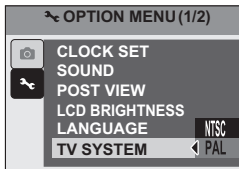

3 Select the desired setting, and press the SET button.

- The selected TV system is set.

HINT

If no image appears on the TV...

- If the TV system setting is not correct for the connected equipment, no image will appear on the TV.

AUTO POWER OFF FUNCTION

Your camera has an “auto power off” function whereby the power automatically turns off after a specified period of inactivity. The auto power off function works to conserve the battery power when the camera is not being used, or to prevent the batteries from dying if the camera has accidentally been left on. You can specify the elapsed time (standby time) before the auto power off function operates to turn the camera off.

1 Display the Option Menu (page 82).

2 Select **AUTO POWER OFF** and press the **SET** button.

- The screen to set the standby time appears.

RECORDING:

Set the standby time for the shooting mode.

PLAYBACK:

Set the standby time for the playback mode.



AUTO POWER OFF FUNCTION

3 Select the desired option, and press the SET button.

- The Standby Time Menu appears.

4 Press the [▲] or [▼] button to select the standby time.

5 Press the SET button.

- The auto power off function is set.
- To return to the Option Menu, press the [◀] button.



FILE No. RESET FUNCTION

If a newly formatted (page 95) card is used, the file name (image number) of the captured image automatically begins from 0001. If the card is subsequently reformatted, or if a different reformatted card is used, the file names again begin from 0001. This is because the file number reset function is set to "ON", and consequently it results in more than one card containing images with the same numbers. By setting the file number reset function to "OFF", even if the card is reformatted or the card is replaced with another card, the consecutive numbering of file names continues from the last number recorded by the camera.

<File number reset function "ON">

	File name (image number)
Card A	0001, 00020012, 0013

:
Replace card



Card B	0001, 00020012, 0013
--------	----------------------------

<File number reset function "OFF">

	File name (image number)
Card A	0001, 00020012, 0013

:
Replace card



Card B	0014, 0015 0025, 0026
--------	-----------------------------

FILE No. RESET FUNCTION

- If Card B already has image data in it when it replaces Card A, file names are assigned as follows.

When the highest image number on Card B (before replacing) is lower than the highest image number on Card A: the file name of the next recorded image continues from last file name recorded on Card A.



When the highest image number on Card B (before replacing) is higher than the highest image number on Card A: the file name of the next recorded image continues from last file name recorded on Card B.



HINT

What about the internal memory?

- The file number reset function works the same for the internal memory.

1 Display the Option Menu (page 82).

2 Select “FILE NO. RESET” and press the SET button.

- The File Number Reset Menu appears.
ON:
The file number reset function is “ON”.
OFF:
The file number reset function is “OFF”.

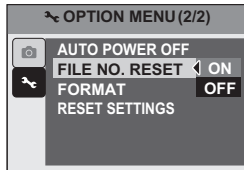

3 Select “OFF”, and press the SET button.

- The file number reset function was set to OFF.

HINT

- Until the file number reset function is turned “ON”, consecutive file names are assigned. It is recommended that the file number reset function be returned to “ON” at the end of each photography session.

INITIALIZING THE CARD MEMORY AND INTERNAL MEMORY

A card must be formatted with this camera:

- After purchasing, when used for the first time, or
- If it was formatted using a personal computer or another digital camera.

The card cannot be reformatted if the lock switch is set to the "LOCK" position. Proceed with the reformat procedure after setting the lock switch to the unlocked position.

1 To reformat a card, install it in the camera. To reformat the camera's internal memory, remove the card from the camera.

2 Display the Option Menu (page 82).

3 Select "FORMAT" and press the SET button.

<Card format>

- The screen to select the type of format appears.
- Follow steps 4 to 6.

FORMAT:

A normal formatting is executed.

FULL FORMAT:

The entire card is scanned and reformatted. It is not possible to select this when there is no card installed, or when the remaining battery charge is low.

<Internal memory format>

- The screen to begin formatting appears.
- Follow steps 5 and 6.

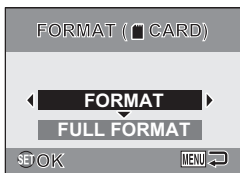

<With card installed>

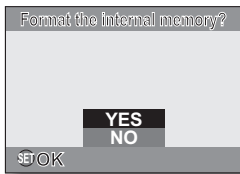

<No card installed>

4 Select the desired format option, and press the SET button.

- The Confirm Format Screen appears.

5 Select "YES".

6 Press the SET button.

- Formatting begins.
- During formatting, "FORMATTING" and "DO NOT POWER OFF" are shown on the monitor.

CAUTION

Caution during reformatting

- Please do not turn off the camera or insert/remove the card while the card is being formatted.

Reformatting erases the data

- When the card or internal memory is initialized, all the recorded data is erased. Protected data is also erased, so before reformatting a card, any data you want to keep should be copied to your personal computer's hard disk or other storage medium.

Caution regarding disposing/transferring the card (recovering data from a reformatted card)

- If a card is reformatted or the data is erased from the card using the camera or a computer, the card's control data may be merely modified and the data itself may not be completely erased from the card.
- In some cases it may be possible to recover the data from a reformatted card using special software for that purpose. However, if the camera is used to execute a full format, it will be impossible to recover the data even by the use of data recovery software.
- If you are disposing of a card, it is recommended that you physically destroy it. If you are transferring the card to someone else to use, it is recommended that you use the camera's full format function to reformat the card, or use commercially available software for erasing card data. Managing data is the responsibility of the user.

HINT

To cancel reformatting

- In step 5, select "NO", and press the SET button.

RESETTING THE CAMERA SETTINGS

Reset the camera to the factory-preset settings.

1 Display the Option Menu (page 82).

2 Select “RESET SETTINGS” and press the SET button.

- The Reset Settings Menu appears.

YES:

Reset to the factory-preset settings.

NO:

Do not change the settings, and return to the Option Menu.

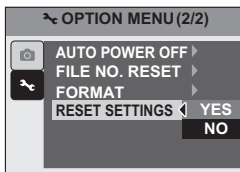

3 Select “YES”, and press the SET button.

- The camera settings are reset to the factory-preset settings.
-

HINT

- Note that the following settings do not change with this procedure:
 - Date and time setting**
 - Language setting**

CHECKING THE REMAINING INTERNAL MEMORY AND CARD MEMORY

You can check the possible number of images, audio recording time and video clip recording time remaining on the card. For a table showing the maximum number of images and recording time for the internal memory and for a specific card, please see “Possible Number of Images/Video Recording Time/Audio Recording Time” on page 128.

1 Press the ON/OFF button to turn the camera on.

<To check the remaining number of still images>

Set the shooting mode to the single shot or sequential shots shooting mode (page 27).

<To check the remaining video clip recording time>

Set the shooting mode to the video clip recording mode (page 27).

- The remaining recording time is shown on the monitor.
- The remaining number of images and video recording time will differ depending on the resolution setting.

Remaining number of images

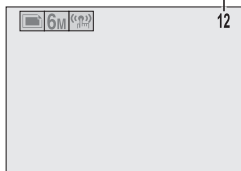

<Still Image Shooting Screen>

Remaining recording time

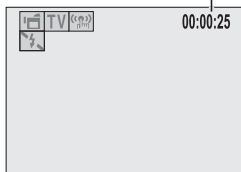

<Video Clip Recording Screen>

CHECKING THE REMAINING INTERNAL MEMORY AND CARD MEMORY

For audio data

- 1 **Set the camera to the audio recording mode (page 59).**
 - The remaining audio recording time is shown.

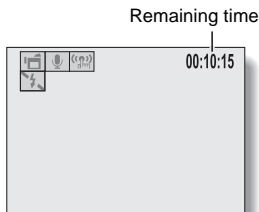

HINT

- When the remaining number of images or the remaining video recording time is "0", you cannot capture any more images. To capture more images, either install a new card, or save the images to a computer and then erase them (page 37) from the card.
- When the remaining number of images or the remaining video recording time is "0", it may be possible to capture a few more images by changing the resolution setting or video clip mode setting (page 58).
- The maximum number of images is 9,999, and the maximum video/audio recording time is 99:59:59. Note that if a large-capacity card is used, the remaining number of images or recording time may not be correctly displayed.

CHECKING THE REMAINING BATTERY CHARGE

When using batteries, the remaining battery charge can be checked on the monitor. Make sure to check this indicator before capturing an image. For an indication of the possible length of time for battery operation, see page 127.



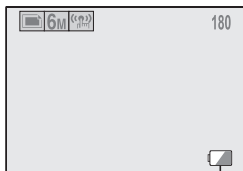

1 Press the ON/OFF button to turn the camera on.

- The battery remaining charge indicator appears in the lower right corner of the monitor.
- Due to the battery characteristics, when the ambient temperature is low,  may appear early for an incorrect indication of the remaining charge.

Also, depending on the conditions of use of the camera or the ambient conditions (temperature, etc.), the indicated remaining charge may change. Therefore, this indication can only be used as a general approximation of the remaining charge.



Battery remaining charge indicator

Battery remaining charge indicator	Battery remaining charge
	Approx. full. (This indicator appears only in certain operation modes.)
	Power is low.
	It will soon be impossible to capture or play back images.
	If this icon flashes when the shutter button is pressed, images cannot be captured. Replace the batteries.

CHECKING THE REMAINING BATTERY CHARGE

HINT

- If any data is present, you can also check the remaining battery charge on the Information Screen (page 81).
- Battery life may differ even among batteries of the same type.
- Depending on the usage of the camera (such as the number of times the flash is used, etc.) or the ambient temperature (temperatures below 10°C [50°F]) the number of images that can be saved on fully charged batteries will vary greatly.
- It is recommended that you prepare extra batteries when taking pictures at a wedding or while traveling, for example, so you don't miss capturing images of important moments due to the battery power running out. The same is recommended for taking photos in cold environments. (In a ski area, for example, the batteries can be kept warm in your pocket until ready to use.)

CONNECTING TO A TV

Connect the supplied AV interface cable from the PC/AV terminal on the digital camera to the AUDIO and VIDEO input terminals on the TV.

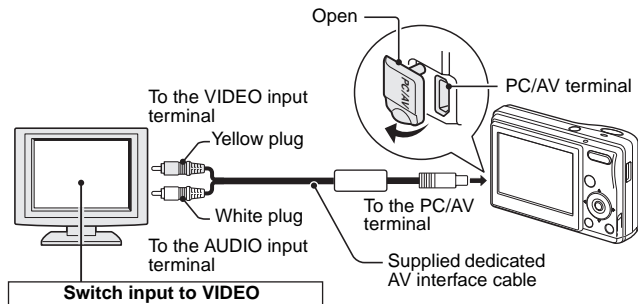

Playback

- After connecting the digital camera to the television, set the TV input switch to VIDEO input.
- When an AV interface cable is connected, no image appears on the camera's monitor.
- The playback method is the same as when viewing images on the camera's monitor.
- The same playback procedure as when playing back with the camera is used to play back voice memos and audio recordings as well.

Voice memo playback: see page 33

Audio playback: see page 60

CAUTION

Insert and pull out the cable carefully

- When connecting the cables, make sure that the cable plugs are correctly oriented and that they match the shapes of the terminal sockets on the devices. Push the plugs in straight when connecting them. If undue force is used to connect a cable, it may permanently damage the connector pins in the terminal socket.
- Do not use excessive force when connecting and disconnecting cables.

DIRECT PRINTING

Your camera supports the PictBridge function. By connecting the camera directly to a PictBridge-enabled printer, the camera's monitor can be used to select images and initiate printing (PictBridge printing).

Print preparations

- 1** Insert the card containing the images you wish to print in the camera.
- 2** Turn the printer on, use the supplied USB interface cable to connect the camera to the printer, and turn the camera on.
 - Connect the camera's PC/AV terminal to the printer's USB connector.
 - The USB Connection Screen appears on the camera's monitor.

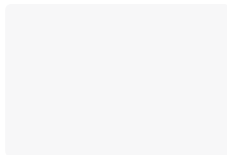

3 Select "PictBridge", and press the SET button.

- The screen to select the images to print appears.



CAUTION

Caution when connecting a printer

- If the power to the printer is turned off while it is connected, the camera may not operate correctly. If the camera does not operate correctly, disconnect the USB interface cable, turn off the camera, and then reconnect the cable.
- During PictBridge printing, the camera's button operation response is slower.
- If the camera is powered by batteries for printing, make sure that the remaining battery charge is sufficient.

Insert and pull out the cable carefully

- When connecting the cables, make sure that the cable plugs are correctly oriented and that they match the shapes of the terminal sockets on the devices. Push the plugs in straight when connecting them. If undue force is used to connect a cable, it may permanently damage the connector pins in the terminal socket.
- Do not use excessive force when connecting and disconnecting cables.

DIRECT PRINTING

To select one image and print it (displayed image)

Procedure to select one still image and print it.

1 Complete the printing setup (page 103).

2 Press the [◀] or [▶] button.
• Specify the image to print.



3 Specify the number of prints.

- ① Select "COPIES", and press the SET button.
- ② Press the [▲] or [▼] button to specify the number of prints.
- ③ Press the SET button.



4 Select PRINT, and press the SET button.

- Printing begins.

HINT

To cancel printing

- ① During printing, press the [▼] button.
 - The Confirm Cancel Printing Screen appears.
- ② Select "YES", and press the SET button.
 - If "EXIT" is selected and the SET button is pressed, printing resumes.

DIRECT PRINTING

To print all the images (all images)

Print all of the images.

1 Complete the printing setup (page 103).

2 Press the **MENU** button.

- The PictBridge Menu appears.



3 Select **PRINT ALL IMAGES**, and press the **SET** button.

- The Print All Images Screen appears.

4 Select **“PRINT”**, and press the **SET** button.

- Printing begins.

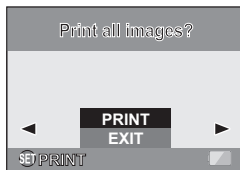

CAUTION

Printing is not possible if there are more than 999 still images in the card.

- Delete unwanted images before printing.

To print the images that are set to print (print reserved images)

Procedure to print all the images that are set to print.

- 1 Make the print settings (page 74), and complete the printing setup (page 103).**

- 2 Press the MENU button.**
 - The PictBridge Menu appears.



- 3 Select DPOF, and press the SET button.**
 - The Print Scheduled Images Screen appears.

- 4 Select "PRINT", and press the SET button.**
 - Printing begins.
 - Printing begins about 1 minute after the SET button is pressed.

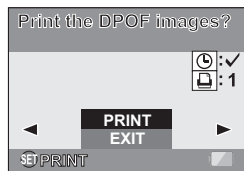

HINT

- In step 2, if you press the [◀] or [▶] button, you can confirm the images that are set to print and their DPOF settings.

CAUTION

- Reserved images printing is not possible if a printer is used that does not support your camera's DPOF function.

DIRECT PRINTING

To change the printer settings and print images (change printer settings)

Images are printed according to settings specified by the camera, such as paper type, size, layout, printing quality, etc.

1 Complete the printing setup (page 103).

2 Select the printer settings tab , and press the **SET** button.

- The Printer Settings Menu appears.

DATE STAMP:

Print the date the photo was taken.

MEDIA TYPE:

Specify the type of paper used for printing.

PAPER SIZE:

Specify the size of paper used for printing.

LAYOUT:

Specify how the images are to be arranged on the paper.

QUALITY:

Select the print quality for the images.

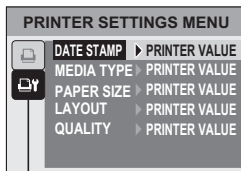

Printer Settings tab

3 Adjust the printer settings.

- ① Use the arrow buttons to select a printer setting parameter, and press the SET button.
 - The screen to set the selected parameter appears.
 - ② Press the [▲] or [▼] button to adjust the setting, and press the SET button.
 - The selected parameter is set, and you are returned to the Printer Settings Menu.
 - Follow the same procedure to adjust the other parameters, as desired.
 - The contents of the settings that can be made for each parameter will differ depending on the printer.
- <When "PRINTER VALUE" is selected>
- The images will be printed according to the settings specified on the printer side.

4 Select "EXIT", and press the SET button.

- You are returned to the Printing Mode Screen.

HINT

- The parameters that are displayed on the Printer Settings Menu will differ depending on the printer that is connected.
- To use printer functions which do not appear on your camera's Printer Settings Menu, select "PRINTER VALUE".
- If a function set by the camera is not available in the printer, the camera's printer settings will automatically change to "PRINTER VALUE".

COMMONLY ASKED QUESTIONS

If you have a question about the camera operation, you might find the answer in this compilation of commonly asked questions.

	Question	Answer	Action
Power	Why doesn't the power turn on?	Due to cold temperatures, the batteries temporarily lost their power.	Place the camera in your pocket to warm it up before using it.
	Why are the batteries consumed so quickly?	The ambient temperature is very low.	Keep the batteries in an environment of 10 to 40°C (50 to 104°F).
		The battery life has expired.	Replace with new batteries.
Why does the  icon appear?	The remaining battery power is low.	Use the separately sold AC adaptor, or replace the batteries with new ones.	
Shooting	Why doesn't the touch sensor work?	You are wearing gloves.	Remove the glove from the hand pressing the shutter button.
	Why doesn't the flash operate?	The camera has determined that the image is bright enough and the flash is not necessary.	Not a malfunction. Capture the image; the camera will determine when the flash is necessary.

	Question	Answer	Action
Shooting	Are the settings retained even after the camera is turned off?	—	All settings except the self-timer and the exposure correction are retained even after the camera is turned off.
	Which resolution setting should I use?	—	Select the resolution setting according to the intended use: 10M 6M 4M : Appropriate for printing letter-size or larger, and for printing a close-up of part of a photo (trimming). 2M : For printing standard photo (photo service) sizes. 0.3M : For photos displayed on a web page, or sent as e-mail attachments.
	What is the difference between the digital zoom and the optical zoom?	—	Because shooting with the optical zoom uses the optics of a physical lens, you can shoot without losing minute details in the image. The digital zoom, on the other hand, works by magnifying a portion of the image that hits the CCD sensor and may produce a coarser image.

COMMONLY ASKED QUESTIONS

	Question	Answer	Action
Shooting	How can I get the distant view into focus?	—	Set the scene function to the landscape  mode when photographing. Or, set the focus range setting to manual focus [MF] , and set the distance to ∞ .
Monitor	When used in cold weather, why does the image seem to leave traces as it moves?	Condition due to the liquid crystals.	Not a malfunction. Spots that appear in the monitor only appear in the monitor and will not be recorded with the images.
	Why does the displayed image contain some red, blue and green dots, or why are black spots visible?		

	Question	Answer	Action
Viewing images	Why is the image too bright?	The subject was too bright.	When capturing an image, devise a way to compensate for a bright subject, for example, by changing the shooting angle.
	Why is the image out of focus?	The focus is not locked properly.	Hold the camera correctly, and when the image is locked in focus, gently press the shutter button all the way to capture the image.
	Why doesn't the zoom jump playback work?	Zoom jump playback does not work for an image that was created from a magnified portion of a zoom jump image, or for video clips.	Not a malfunction.
	Why is there no image (ⓧ is shown)?	This may happen when trying to play back images stored on a card from a different digital camera.	Play back images that were recorded on a card using this camera.
	Why do vertical stripes appear?	If a bright subject is shot in the video clip recording mode, vertical stripes may appear on the monitor or in the image.	Not a malfunction.

COMMONLY ASKED QUESTIONS

	Question	Answer	Action
Viewing images	Why isn't the magnified image clear?	Due to the characteristics of the camera, magnified images appear less clear.	Not a malfunction.
	Why isn't the captured image clear?	The image was captured using the digital zoom.	Not a malfunction. Zoom in only within the optical zoom range when shooting.
	Can I play back image data that I edited using my computer?	—	We cannot guarantee the accurate playback of data that has been edited using a computer.
Printing	Why does a message appear during PictBridge printing?	There is a problem with the printer.	Please refer to the instruction manual for your printer.
Misc.	Why does the "CARD FULL" or "INTERNAL MEMORY FULL" message appear?	There is no more available memory on the card or in the camera's internal memory.	Erase unnecessary data, or use a card that has more memory available.
	Why does the "CARD IS PROTECTED" message appear?	The lock switch on the card is in the locked (protect) position.	Move the lock switch to the unlocked position.

	Question	Answer	Action
Misc.	Why can't the camera be operated?	A temporary internal circuitry problem may be the cause.	Remove the AC adaptor and batteries from the camera, wait a few minutes, then reinstall the batteries and try again.
	Can I use my camera abroad?	—	If you have questions about using the AC adaptor and power cord abroad, please consult with a dealer near you for advice.
	Why does the "SYSTEM ERROR" message appear?	A problem has occurred within the camera or card.	Check the following items: ① Remove the card and then install it again. ② Remove the batteries and then install them again. ③ Install a different card. If "SYSTEM ERROR" still appears after performing the above steps, then take the camera to the dealer for service.

TROUBLESHOOTING

Before taking your camera to the repair shop, check the following table for a possible solution to the problem.

CAMERA

	Problem	Cause	Action	Reference page
Power	No power.	The batteries are dead.	Insert new batteries.	14
		The batteries have not been inserted correctly.	Reinsert the batteries, making sure to orient them correctly.	
		The battery/card cover is not completely closed.	Close the battery/card cover completely.	
	The camera turns off by itself.	The power save function is operating.	Not a malfunction.	18
Shooting	An image is not captured when the shutter button is pressed.	The power is not turned on.	If the auto power off function was activated, turn the camera on before shooting. If the camera was turned off, press the ON/OFF button to turn it on.	18

	Problem	Cause	Action	Reference page
Shooting	An image is not captured when the shutter button is pressed.	The maximum number of images that can be captured or the maximum video clip recording time has been reached.	Install a new card. Erase the images that are not necessary. Save the images to separate media, then erase all the images from the card.	14 37, 95
	The operation buttons (arrow buttons, MENU button, etc.) do not work.	A finger is touching the shutter button, and the focus lock is active.	Remove your finger from the shutter button, and then use the operation buttons.	—
	The flash does not operate.	The flash off mode is selected.	Set the flash to automatic flash mode or forced flash mode.	48
		The batteries are dead.	Insert new batteries.	14
	The digital zoom does not work.	The still image mode is set to [10M] .	Set the still image mode resolution setting to [6M] or lower.	58
	A warning tone (beep-beep-beep) sounds, and it is not possible to take a picture using the self-timer.	The batteries are consumed.	Insert new batteries.	14

TROUBLESHOOTING

	Problem	Cause	Action	Reference page
Shooting	When zooming in or out, the zoom movement stops momentarily.	The optical zoom has moved to the maximum magnification position.	Not a malfunction. Release the zoom switch, and press it again.	47
	There is noise in the captured image.	The ISO sensitivity setting is too high.	Set the ISO sensitivity to a lower setting.	62
Monitor	No playback image appears.	The playback mode is not active.	Press the playback button [▶].	26
Viewing images	The image is too dark.	The flash was blocked by a finger or other object.	Hold the camera correctly, and make sure the flash is not obstructed.	22
		The subject was too far away.	Capture the image in the range of operation of the flash.	126
		The subject was lit from behind.	Use the forced flash mode.	48
			Use the exposure correction function.	65
There is not enough light.	Adjust the ISO sensitivity setting.	62		











	Problem	Cause	Action	Reference page
Viewing images	The image is too bright.	The forced flash mode is selected.	Select a different flash mode.	48
		The subject was too bright.	Use the exposure correction function.	65
		The ISO sensitivity setting is incorrect.	Set the ISO sensitivity to ISO-A .	62
	The image is not in focus.	The subject is too close to the camera.	Select the correct focus setting for your needs.	31, 52
		The focus setting is not correct.		
		The camera moved when the shutter button was pressed.	Hold the camera correctly and press the shutter button correctly.	22, 31
		The focus is not locked properly.		
		The lens is dirty.		
	The colors of the images captured indoors are not correct.	This is due to ambient lighting.	Capture the image using the forced flash mode.	48
		The white balance setting is incorrect.	Set the white balance setting correctly.	63

TROUBLESHOOTING



	Problem	Cause	Action	Reference page
Viewing images	A part of the image is missing.	The handstrap or a finger was blocking the lens or lens opening.	Hold the camera correctly, and make sure the lens is not obstructed.	22
	"NO IMAGE" is shown.	There is no image stored in the installed card or the internal memory.	Play back after capturing images.	31, 33
Image editing	You cannot edit or rotate an image.	The protect mode is set.	Cancel the protect mode.	68
Misc.	The "PROTECTED" message appears and the data cannot be erased.	You have attempted to erase data that is protected from accidental erasure.	Set the protect setting for the data to OFF.	68
	The recording capacity is less than that indicated in the section "Possible No. of Images/ Possible Shooting Time/ Possible Recording Time".	The recording capacity is less than the value specified for the card.	Depending on the card, the capacity may be less than the specified value. Please refer to the instructions that accompanied the card.	128

Notes regarding the scene function

During still image shooting

	The macro  focus range setting is not available.
	
	The resolution is fixed at 0.3M . The flash is disabled even when shooting single shots.
	The macro  focus range setting is not available.
	
	The macro  and manual focus MF focus range settings are not available. The flash is disabled even when shooting single shots.
	The 10M resolution setting is not available.

About the scene function and focus range settings

- The scene function changes to **AUTO** when the focus range is set to .
- Even if you set the focus range to **MF**, it changes to  when the scene function is set to a .

SPECIFICATIONS

Camera

Type	CCD digital camera (recording and playback)
Recording system	Digital recording
Image file format	Still images: JPEG format (DCF, DPOF, Exif 2.2 compliant) Note: Designed mainly by the Japan Electronics and Information Technology Industries Association (JEITA), DCF (Design rule for camera file system) is standard for digital still camera image files to provide interoperability between digital photography devices for the images stored on removable memory cards. However, it is not guaranteed that all devices will support the DCF standard. Video clips: QuickTime Movie (Photo-JPEG)
Data storage media	Internal memory: Approx. 22 MB External memory: SD Memory Card, Multi Media Card
Camera effective number of pixels	Approx. 6 million pixels
Image sensor	1/2.5-inch CCD Virtual number of pixels: Approx. 6.18 million pixels, interlace scan, primary color filter

Recording resolution	10M : 3,680 × 2,760 pixels (single-shot still images only) 6M : 2,816 × 2,112 pixels (single-shot still images and sequential shots only) 4M : 2,288 × 1,712 pixels (single-shot still images and sequential shots only) 2M : 1,600 × 1,200 pixels (single-shot still images and sequential shots only) 0.3M : 640 × 480 pixels (single-shot still images and sequential shots only) TV : 640 × 480 pixels, 30 frames/second (video clip recording only) WEB : 320 × 240 pixels, 15 frames/second (video clip recording only)	
White balance	Full-auto TTL, manual setting possible	
Lens	3.0x optical zoom lens	f=5.8 mm to 17.4 mm (35 mm film camera conversion f=35 mm to 105 mm) Autofocus, 5 groups, 6 elements (2 with aspheric surfaces), internal ND filter
Aperture	Open F=2.8 (Wide) to 4.9 (Tele) Alternative ND filter	
Exposure control type	Programmable AE Exposure correction available from the Recording Menu (0±1.8EV in 0.3EV steps)	
Light-measuring modes	Multi-section measuring	

SPECIFICATIONS

Range	Normal photography: 10 cm (3.94 in.) to ∞ (Wide), 40 cm (15.75 in.) to ∞ (Tele) Macro photography: 5 cm (1.97 in.) to 70 cm (27.56 in.) (Wide), 40 cm (15.75 in.) to 70 cm (27.56 in.) (Tele)
Digital zoom	For shooting: 1x to 4x (except resolution 10M) For playback: 1x to 57.5x (varies with resolution)
Shutter speed	Single-shot mode: 1/2 to 1/1,500 sec. (Maximum approx. 2 seconds when the scene function is set to fireworks  etc.) (During flash: 1/30 to 1/1,500 sec.) Sequential shots shooting mode: 1/2 to 1/1,500 sec. Video clip recording mode: 1/30 to 1/10,000 sec.
Sensitivity	Single-shot mode/sequential shots shooting mode: Auto (equivalent to ISO50 to 200)/equivalent to ISO50, ISO100, ISO200, and ISO400 (switchable from Recording Menu) Video clip recording mode: Auto (equivalent to ISO200 to 800)/equivalent to ISO200, ISO400, ISO800, and ISO1,600 (switchable from Recording Menu)
Monitor	2.5-inch TFT color LCD Approx. 115,000 pixels (Frame coverage: Approx. 100%) Brightness adjustment: 5-step, auto

Flash working range		GN = 6.0 Approx. 10 cm (3.94 in.) to 3.0 m (9.84 ft.) (Wide) Approx. 40 cm (15.75 in.) to 1.7 m (5.58 ft.) (Tele)
Flash modes		Auto-flash, forced flash, flash off, red-eye reduction
Focus		TTL-type AF (9-point range finder/spot focus), manual focus (14 steps)
Self-timer		Approx. 2-second delay, 10-second delay
Ambient environment	Temperature	0 to 40°C (32 to 104°F) (operation), -20 to 60°C (-4 to 140°F) (storage)
	Humidity	30 to 90% (operating, no condensation) 10 to 90% (storage, no condensation)
Power supply	Batteries	AA-size alkaline batteries × 2 The following batteries can also be used: AA-size Ni-Cd batteries (SANYO N-3UV) × 2 AA-size nickel metal hydride rechargeable batteries (SANYO HR-3UTG) × 2 * AA-size manganese batteries cannot be used.
	AC adaptor (sold separately)	Model VAR-G4AEX for Europe, U.K. and others, and model VAR-G4AU for North America and others Accommodates DC Adaptor VAR-A1 (sold separately)
Dimensions (at narrowest part, not including grip or lens protrusion)		89.0(W) × 60.5(H) × 21.3(D) mm 3.50" (W) × 2.38" (H) × 0.84" (D)
Weight		Approx. 118 g (4.16 oz.) (without batteries and card)

SPECIFICATIONS

Camera connectors

PC/AV (communication/sound and image output) terminal	Dedicated regrouped jack	
	Audio output	880 mVrms (-1.1 dBs), 2.2 k Ω or less, monaural
	Video output	1.0 Vp-p, 75 Ω unbalanced, sync negative, composite video, NTSC color TV system/PAL TV system (switchable from the Option Menu)
	USB	USB 2.0 Full Speed

Battery life

	Alkaline batteries (supplied)	Nickel metal hydride batteries sold separately: (HR-3UTG)
Possible No. of Images*	240 images	550 images
Maximum playback time**	500 min.	650 min.

* According to the CIPA standard (when using a Matsushita Electric Industrial Co., Ltd. 64MB SD Memory Card).

** With continuous playback when using the monitor.

NOTE

- Approximate time until batteries run out, based on test conditions at room temperature (25°C [77°F]).
- The battery operation time may vary depending on the conditions of the batteries and the conditions of use. Especially when used at temperatures below 10°C (50°F), the battery operation time is drastically reduced.

Possible Number of Images/Video Recording Time/Audio Recording Time

The table shows the possible number of captured images and the possible recording time for the camera's internal memory and for the commercially available 128MB and 1GB SD Memory Cards.

Shooting mode setting	Resolution setting	Internal memory	SD Memory Card	
			128 MB	1 GB
Single-shot mode/ Sequential shots mode	10M ^{*1}	6 images	37 images	290 images
	6M	11 images	64 images	495 images
	4M	17 images	96 images	746 images
	2M	34 images	190 images	1,470 images
	0.3M	175 images	978 images	7,550 images
Video clip mode	TV	15 sec.	1 min. 26 sec.	11 min. 4 sec.
	WEB	1 min. 6 sec.	6 min. 12 sec.	47 min. 58 sec.
Audio file mode	—	46 min. 39 sec.	4 hr. 20 min.	33 hr. 35 min.

- Even with cards of the same capacity, the amount of data that can actually be stored may differ depending on the card brand, etc.
- The continuous shooting time will differ depending, for example, on the card type, capacity, performance, etc.

^{*1}: Available only for single-shot still image shooting.

SPECIFICATIONS

Others

Apple, Macintosh and QuickTime are trademarks or registered trademarks of Apple Computer Inc.

Windows and Windows XP are registered trademarks of Microsoft Corporation.

All other company and product names are registered trademarks or trademarks of their respective owners.

CAUTION

- It is forbidden to copy this manual, whole or in part, without prior written permission.
- All images and illustrations given in this manual are for explanation purposes and may differ slightly from that of the actual product. Also, actual specifications are subject to change without prior notice and therefore may differ from the contents of this manual.
- Sanyo Electric shall not be held responsible for any problems resulting from the use of this camera.
- Sanyo Electric declines all responsibility for damages due to improper use of the camera, failure to adhere to the instructions given in this manual, or repairs or changes done by those other than a technician authorized by the manufacturer.
- Sanyo Electric shall not be held responsible for any damage caused by optional devices or consumable items used with the camera other than those supplied with the camera or those specified by Sanyo Electric.
- Sanyo Electric shall not be held responsible for any losses or loss of revenue resulting from the loss of data caused by the malfunction, or the repairing of a malfunction, of the camera.
- The images captured with this camera will differ in quality from pictures taken with a standard film camera.

HINTS FOR TAKING PICTURES

Taking great pictures in difficult surroundings is easier than you might think. By keeping a few points in mind and choosing the correct settings, you can create photos that you'll be proud to display and share.

Basic photography

If images are blurred even when the autofocus is used

Your camera employs an autofocus function. When you snap a picture using the autofocus, the camera automatically adjusts the settings so that the image will be in focus. If you are getting blurred images even when using the autofocus, one or more of the following might be the reason.

■ How the autofocus works

The autofocus is activated when the shutter button is lightly touched. Press the shutter button slightly, and the target mark will appear on the monitor to indicate that the autofocus has been activated. Next, continue to gently press the shutter button all the way to snap the picture. This two-step method is the way to ensure that your photos are perfectly focused.

■ Reasons for unfocused images

- ① The shutter button was pressed before the image was focused.
- ② After the image was focused, the subject moved.
 - Even if camera focuses the subject once, if the distance between the camera and the subject is changed, the subject may become out of focus.
- ③ The focus setting is not set for the correct distance.
 - If you shoot a close-up subject with the camera set to the normal focus mode, or if you shoot a subject at normal distance with the camera set to the macro (close-up) mode, the image will not be in focus.

■ Preventing blurred images

- ① Confirm that the camera is set to the correct focus mode for your subject.
- ② Hold the camera correctly, and lightly touch the shutter button.
- ③ Wait for the target mark to appear in the monitor, and holding the camera steady, gently continue to press the shutter button all the way down.

Following these steps for a gentle but firm pressing of the shutter button will ensure that you get beautifully focused photos.

HINTS FOR TAKING PICTURES

Photographing a moving subject

Situation: You would like to snap an action shot of a moving child or pet. The autofocus is activated, but because the subject is moving, the image may be blurred. In particular, when the distance between the camera and the subject is changing, it is difficult to lock the focus on the subject. Here are some hints for successfully capturing images of moving subjects.

■ Reasons for unfocused images

When the shutter button is touched lightly, the camera's autofocus works by determining the distance between the camera and the subject. Once the subject is in focus, if it then moves before the picture is snapped, the image may be out of focus. This often happens when you once lock the focus on a subject and then wait for the right moment to snap the picture. And, conversely, a blurred image may result if you press the shutter button all the way in one step in an attempt to quickly capture an action scene, thus failing to activate the autofocus in time.

■ Preventing blurred images (How to use the manual focus [page 52])

In addition to the autofocus, a manual focus mode is also incorporated in your camera. In the autofocus mode, the distance between the camera and the subject is automatically determined when you press the shutter button halfway. In contrast to this, with the manual focus mode, you manually set the focus by specifying the correct distance between the camera and the subject before taking the picture.

■ How to photograph a moving subject

- ① Set the camera's focus mode to the manual focus. Set the focus distance to the correct distance between the camera and the subject.
- ② When the subject is at the set focus distance, gently press the shutter button all the way down.

<Advantage of using the manual focus>

- Images can be quickly captured without waiting for the autofocus to activate.
- Because you are presetting the focus distance, the focus can be more accurate.

<Using the manual focus effectively>

- When photographing a moving subject, press the shutter button just before the subject reaches the focus distance, and the shutter will be released when the subject is at the correct distance.
- Use manual focus to avoid incorrectly focused images when there is an object between the camera and the subject you wish to focus on.

Shooting with the scene function

Shooting portraits (portrait mode)

Points:

- Choose a background that doesn't detract from your subject.
- Move in close to your subject.
- Pay attention to lighting and how it affects your subject.

NOTE

- If the background is distracting, it will not show your subject to his best advantage. Move in closer to your subject or zoom in so that the background does not compete with the subject.
- In portrait photography your subject is clearly the central figure, so try techniques that allow the subject to stand out.
- If light is coming from behind your subject (backlit), his face will appear dark. You can get a better picture by using the flash, for example, or changing the exposure setting.

Photographing moving subjects (sports mode)

Points:

- Match the camera's movement with that of the subject.
- Set the zoom to the Wide end (wide-angle).
- Don't be too hesitant to press the shutter button, or you'll miss the action.

NOTE

- Tips to not missing those great action shots: Make sure you're holding the camera correctly. Keep the subject in the lens at all times, moving the camera with him while waiting for the right shot. Move your whole body—not just your arms—with the camera while shooting.
- Blurred images are more likely when the zoom is set to the Tele end than the Wide end. Set the zoom as close as possible to the Wide end.
- Learn to press the shutter button quickly yet smoothly the instant your photo chance occurs.

HINTS FOR TAKING PICTURES

Night photography (night view mode)

Points:

- Avoid camera shake.
- Increase the ISO sensitivity.

NOTE

- Camera shutter speed during night photography is considerably slower, so there is a much greater chance that your photographed images will be blurry. Use a tripod whenever possible, or if a tripod is not available, you can lean against a wall or pillar to help stabilize the camera.
- You can photograph your subject with the night scene in the background by using the flash. Be careful not to shoot too close to the subject, however, or your subject's face will appear too bright.
- After the flash operates, keep the camera and the subjects motionless for about 2 seconds.

Photographing scenery (landscape mode)

Points:

-

SANYO

SANYO Electric Co., Ltd.