

# Panasonic®



## DVD Home Theater Sound System

### Operating Instructions

---

Model No. **SC-HT650**

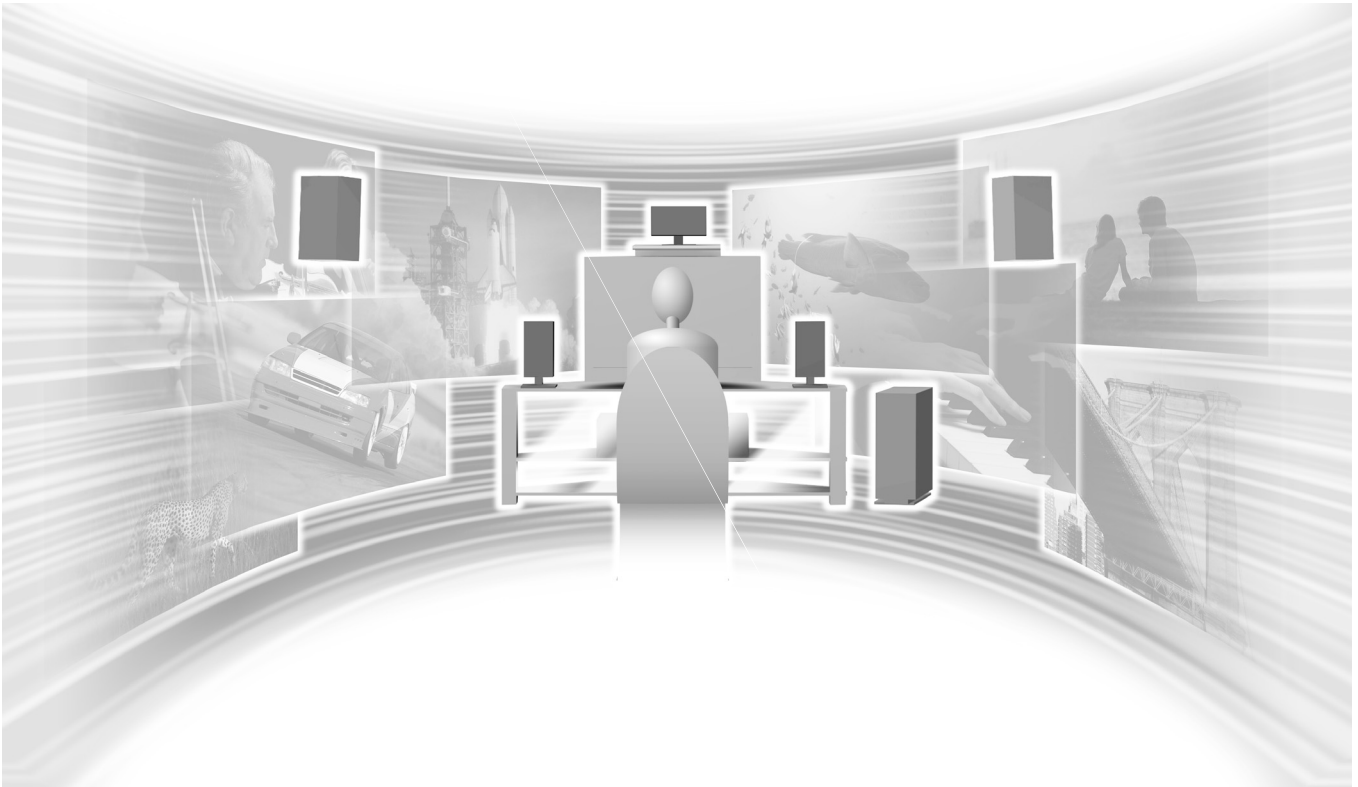

# Dear customer

Thank you for purchasing this product.  
For optimum performance and safety, please read these instructions carefully.

Operations in these instructions are described mainly with the remote control, but you can do the operations on the main unit if the controls are the same.

<b>System</b>	SC-HT650
<b>Main unit</b>	SA-HT650
<b>Front and Surround speakers</b>	SB-AFC650
<b>Center speaker</b>	SB-PC650
<b>Subwoofer</b>	SB-W650

## CAUTION!

**THIS PRODUCT UTILIZES A LASER.**  
**USE OF CONTROLS OR ADJUSTMENTS OR PERFORMANCE OF PROCEDURES OTHER THAN THOSE SPECIFIED HEREIN MAY RESULT IN HAZARDOUS RADIATION EXPOSURE.**  
**DO NOT OPEN COVERS AND DO NOT REPAIR YOURSELF.**  
**REFER SERVICING TO QUALIFIED PERSONNEL.**

## WARNING:

**TO REDUCE THE RISK OF FIRE, ELECTRIC SHOCK OR PRODUCT DAMAGE, DO NOT EXPOSE THIS APPARATUS TO RAIN, MOISTURE, DRIPPING OR SPLASHING AND THAT NO OBJECTS FILLED WITH LIQUIDS, SUCH AS VASES, SHALL BE PLACED ON THE APPARATUS.**

## CAUTION!

**DO NOT INSTALL OR PLACE THIS UNIT IN A BOOKCASE, BUILT-IN CABINET OR IN ANOTHER CONFINED SPACE. ENSURE THE UNIT IS WELL VENTILATED. TO PREVENT RISK OF ELECTRIC SHOCK OR FIRE HAZARD DUE TO OVERHEATING, ENSURE THAT CURTAINS AND ANY OTHER MATERIALS DO NOT OBSTRUCT THE VENTILATION VENTS.**



**CAUTION**  
**RISK OF ELECTRIC SHOCK**  
**DO NOT OPEN**



**CAUTION:** TO REDUCE THE RISK OF ELECTRIC SHOCK, DO NOT REMOVE SCREWS. NO USER-SERVICEABLE PARTS INSIDE. REFER SERVICING TO QUALIFIED SERVICE PERSONNEL.



The lightning flash with arrowhead symbol, within an equilateral triangle, is intended to alert the user to the presence of uninsulated "dangerous voltage" within the product's enclosure that may be of sufficient magnitude to constitute a risk of electric shock to persons.



The exclamation point within an equilateral triangle is intended to alert the user to the presence of important operating and maintenance (servicing) instructions in the literature accompanying the appliance.

<b>CAUTION</b>	- LASER RADIATION WHEN OPEN. DO NOT STARE INTO BEAM. FDA 21 CFR / Class II
<b>CAUTION</b>	- VISIBLE AND INVISIBLE LASER RADIATION WHEN OPEN. AVOID EXPOSURE TO BEAM. IEC60825-1 / Class 3b
<b>VARNING</b>	- SYNLIIG OCH OSYNLIIG LASERSTRÅLNING NÄR DENNA DEL ÄR ÖPPNAD. BETRÄKTA EJ STRÅLEN.
<b>ADVARSEL</b>	- SYNLIIG OG USYNLIIG LASERSTRÅLING VED ÅBNING. UNDGÅ UDSÆTTELSE FOR STRÅLING.
<b>ADVARSEL</b>	- SYNLIIG OG USYNLIIG LASERSTRÅLING NÄR DEKSEL ÅPNS. UNNGÅ EXPOSERING FÖR STRÅLEN.
<b>VARO!</b>	- AVATTAESSA OLET ALTIINNA NÄKYVÄÄ JA NÄKYMÄTÖN LASERSÄTELYLLÄ. ÄLÄ KATSO SÄTEESEEN.
<b>VORSICHT</b>	- SICHTBARE UND UNSICHTBARE LASERSTRÄHLUNG. WENN ABDECKUNG GEÖFFNET, NICHT DEM STRAHL AUSSETZEN.
<b>ATTENTION</b>	- RAYONNEMENT LASER VISIBLE ET INVISIBLE EN CAS D'OUVERTURE. EXPOSITION DANGEREUSE AU FAISCEAU.
<b>注意</b>	- 打开有可见及不可见激光辐射，请勿直视辐射物。
<b>注意</b>	- ここを開くと可視及び不可視レーザー光が出ます。ビームを見たり、触れたりしないで下さい。 ROLXS0054

(Inside of product)

## CAUTION:

This equipment has been tested and found to comply with the limits for a Class B digital device, pursuant to Part 15 of the FCC Rules.

These limits are designed to provide reasonable protection against harmful interference in a residential installation. This equipment generates, uses and can radiate radio frequency energy and, if not installed and used in accordance with the instructions, may cause harmful interference to radio communications. However, there is no guarantee that interference will not occur in a particular installation. If this equipment does cause harmful interference to radio or television reception, which can be determined by turning the equipment off and on, the user is encouraged to try to correct the interference by one or more of the following measures:

- Reorient or relocate the receiving antenna.
- Increase the separation between the equipment and receiver.
- Connect the equipment into an outlet on a circuit different from that to which the receiver is connected.
- Consult the dealer or an experienced radio/TV technician for help.

Any unauthorized changes or modifications to this equipment would void the user's authority to operate this device.

This device complies with Part 15 of the FCC Rules. Operation is subject to the following two conditions: (1) This device may not cause harmful interference, and (2) this device must accept any interference received, including interference that may cause undesired operation.

# Accessories



Please check and identify the supplied accessories. Use numbers indicated in parentheses when asking for replacement parts.

To order accessories contact 1-800-332-5368 or the website (<http://www.panasonic.com>).

- 1 Remote control (EUR7623XD0)

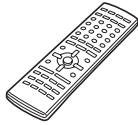

- 1 AM loop antenna set (RSA0012-L)

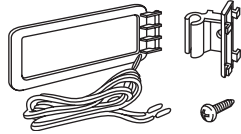

- 2 Batteries for remote control



- 1 FM indoor antenna (RSA0006-J)



- 1 AC power supply cord (RJA0065-1D)

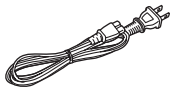

- 1 Sheet of speaker feet (RFA0631A-K)  
Replacements sold in sets of 4.



- 1 Video cable (RJL1P016B15A)



- 1 Sheet of speaker-cord stickers (12 stickers)  
One set is extra.  
The sheet cannot be purchased separately.

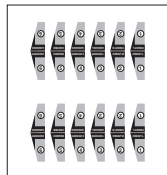

### Note

The included AC power supply cord is for use with this unit only. Do not use it with other equipment.

### User memo:

DATE OF PURCHASE _____
DEALER NAME _____
DEALER ADDRESS _____
TELEPHONE NUMBER _____

The model number and serial number of this product can be found on either the back or the bottom of the unit. Please note them in the space provided below and keep for future reference.	
MODEL NUMBER _____	SC-HT650
SERIAL NUMBER _____	

# Table of contents

## Getting started

- Accessories ..... 3
- IMPORTANT SAFETY INSTRUCTIONS ..... 4
- Disc information ..... 5

### Simple setup

- STEP1 Locating ..... 6
- STEP2 Speakers ..... 7
- STEP3 Television ..... 8
- STEP4 Antennas and AC power supply cord ..... 9
- STEP5 The remote control ..... 9
- STEP6 QUICK SETUP ..... 10

- Control reference guide ..... 11

## Disc operations

- Discs—Basic play ..... 12
  - Using the disc manager/Position Memory function ..... 13
  - Replaying a scene—QUICK REPLAY ..... 14
  - Starting play from a selected item ..... 14
  - Selecting still pictures—Page Skip ..... 14
  - Skipping items/Fast forward and rewind—SEARCH ..... 14
  - Slow-motion play/Frame-by-frame viewing ..... 14
- Discs—Convenient functions ..... 15
  - Selecting groups to play ..... 15
  - Repeat play/A-B repeat play ..... 15
  - Soundtracks/Subtitles ..... 16
  - All group play/Program play/Random play ..... 17
  - Marking places to play again ..... 18
  - Variable Zoom function ..... 18
- Playing the programs or play lists on DVD-RAM ..... 19
  - Selecting a program to play—DIRECT NAVIGATOR ..... 19
  - Using the play list menu ..... 19
- WMA/MP3, CD text and JPEG navigation menus ..... 20
  - Playing HighMAT discs ..... 21
- Using On-Screen Menu Icons ..... 22
  - Common procedures/Progress indicator ..... 22
  - Disc information/Unit information ..... 23

## Radio operations

- The radio ..... 25
  - Manual tuning/Preset tuning ..... 25

## Sound field/sound quality operations

- Sound field ..... 26
  - Dolby Digital and DTS/Dolby Pro Logic ..... 26
  - Speaker level adjustments ..... 26
  - Super Surround/Sound Field Control ..... 27
  - Center Focus/Seat Position ..... 27
- Sound quality ..... 28
  - Adjusting the bass ..... 28
  - Double re-master—Enjoying more natural sound ..... 28

## Other functions

- Convenient functions ..... 29
  - Muting the volume/Turning off the display ..... 29
  - Timer functions/Using headphones ..... 29
- Operating other equipment ..... 30
- Changing settings ..... 32
- Optional antenna connections ..... 34

## Reference

- Glossary ..... 35
- Maintenance ..... 35
- Specifications ..... 36
- Troubleshooting guide ..... 37
- Limited Warranty ..... 39
- Product Service ..... Back cover

## Installation

### Placement

1. **Ventilation**—Situate the unit so that it receives proper ventilation. Do not install in a confined space such as a bookcase or cabinet. Allow at least 10 cm (4 inches) clearance from the rear of the unit. To prevent the risk of electric shock or fire due to overheating ensure curtains and other materials do not obstruct the unit's ventilation.
2. **Foreign material**—Ensure objects and liquids do not get into the unit. Avoid exposing the unit to excessive smoke, dust, mechanical vibration, and shock.
3. **Magnetism**—Situate the unit away from equipment and devices that generate strong magnetic fields.
4. **Stacking**—Do not place heavy objects on top of this unit.
5. **Surface**—Place the unit on a flat, level surface.
6. **Carts and stands**—Use the unit only with carts and stands recommended by the manufacturer. Move carts with care. Sudden stops, excessive force, and uneven surfaces can cause carts to overturn.
7. **Wall and ceiling mounting**—Do not mount the unit on walls or ceilings unless specified in the instructions.

### Environment





1. **Water and moisture**—Do not use the unit near water, such as near a bathtub or swimming pool. Avoid damp basements.
2. **Heat**—Situate the unit away from heat sources, such as radiators.  
Do not situate where temperatures fall below 5°C (41°F) or rise above 35°C (95°F).

(See page 35 for details.)

Unplug the unit from the household AC outlet before cleaning.  
Clean with a damp cloth.  
Do not use abrasive pads, scouring powders, or solvents.

1. **Damage requiring service**—The unit should be serviced by qualified service personnel if:
  - (a)The AC power supply cord or the plug has been damaged; or
  - (b)Objects or liquids have gotten into the unit; or
  - (c)The unit has been exposed to rain; or
  - (d)The unit does not operate normally or exhibits a marked change in performance; or
  - (e)The unit has been dropped or the cabinet damaged.
2. **Service**—Do not attempt to service the unit beyond that described in these operating instructions. Refer all other servicing to authorized servicing personnel.
3. **Replacement parts**—When parts need replacing ensure the servicer uses parts specified by the manufacturer or parts that have the same characteristics as the original parts. Unauthorized substitutes may result in fire, electric shock, or other hazards.
4. **Safety check**—After repairs or service, ask the servicer to perform safety checks to confirm that the unit is in proper working condition.

## Discs that can be played

Disc type	Logo	Indication used in instructions
DVD-RAM		<b>RAM</b>
DVD-Audio		<b>DVD-A</b>
DVD-Video		<b>DVD-V</b>
DVD-R		
Video CD		<b>VCD</b> Including SVCD (Confirming to IEC62107)
CD		<b>CD</b> Including CD text
CD-R/RW	—	<b>WMA</b> <b>MP3</b> <b>JPEG</b>

- Use discs with the above logos and that conform to specifications. The unit cannot play other shaped discs correctly.
- Do not use irregularly shaped discs (e.g. heart-shaped), as these can damage the unit.

## Discs that cannot be played

PAL discs (except DVD-Audio), DVD-ROM, CD-ROM, CDV, CD-G, +RW, DVD-RW, SACD, Divx Video Discs, Photo CD and “Chaoji VCD” available on the market including CVD, DVCD and SVCD that do not conform to IEC62107.

## Disc structure

Disc structure and the labels given to the items on discs depend on the disc type.

- Track:** the smallest division on DVD-Audio, CDs and Video CDs, or a single WMA/MP3 file.
- Chapter:** the smallest division on DVD-Video.
- Group:** collections of tracks on DVD-Audio and equivalent to folders or albums on data discs.
- Title:** the largest division on DVD-Video, usually an entire movie.
- Program:** the division on DVD-RAM equivalent to a single recording.
- Picture:** a single JPEG file.
- Play list:** the largest grouping on a HighMAT disc, or a group of scenes on DVD-RAM.
- Scene:** DVD-RAM program sections specified and grouped into play lists on a DVD video recorder.
- Content:** covers tracks and pictures on HighMAT discs.

## Playing DVDs and Video CDs

The producer of these discs can control how they are played so you may not always be able to control play as described in these operating instructions (for example if the play time is not displayed or if a Video CD has menus). Read the disc's instructions carefully.

## DVD-RAM discs

DVD-RAM discs must meet the following conditions for this unit to be able to play them.

Type	<ul style="list-style-type: none"> <li>• Non-cartridge discs</li> <li>• Discs that can be removed from their cartridges (TYPE 2 and 4)</li> </ul>
Capacity	<ul style="list-style-type: none"> <li>• 12 cm (5") 9.4 GB (double-sided) and 4.7 GB (single-sided)</li> <li>• 8 cm (3") 2.8 GB (double-sided)</li> </ul>
Recording format	Discs recorded with DVD video recorders, DVD video cameras, personal computers, etc., using Version 1.1 of the Video Recording Format (a unified video recording standard).

- Remove TYPE 2 and 4 discs from their cartridges before use, then return them when you are finished. Read the instructions for the disc carefully.
- Do not allow the disc to become dirty or scratched. Store discs in their cartridges and ensure the disc label and cartridge label face the same way.
- Some parts of the disc, for example where one program ends and another begins, may not play smoothly.

## DVD-R discs

Panasonic DVD-R recorded and finalized on a Panasonic DVD video recorder are played as DVD-Video on this unit.

## CD-R and CD-RW discs

This unit can play CD-R/RW (audio recording disc) recorded with CD-DA, video CD, SVCD (conforming to IEC62107), WMA, MP3 or JPEG. Close the sessions or finalize the disc after recording.

## HighMAT discs

This unit is compatible with HighMAT discs containing WMA, MP3, and/or JPEG files.

### Note

It may not be possible to play CD-R, CD-RW, DVD-R and DVD-RAM in all cases due to the type of disc or condition of the recording.

## Playing PAL system DVD-Audio

This unit converts PAL to NTSC for play. The picture is compressed to show it in its entirety, but this may cause it to be stretched vertically.

## To clean discs

### DVD-Audio, DVD-Video, Video CD, CD

Wipe with a damp cloth and then wipe dry.

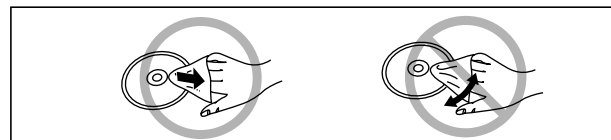

### DVD-RAM, DVD-R

- Clean with an optional DVD-RAM/PD disc cleaner (LF-K200DCA1, where available).
- Never use cloths or cleaners for CDs etc.

## Handling precautions

- Do not write on the label side with a ball-point pen or other writing instrument.
- Do not use record cleaning sprays, benzine, thinner, static electricity prevention liquids or any other solvent.
- Do not attach labels or stickers to discs. (Do not use discs with exposed adhesive from tape or left over peeled-off stickers.)
- Do not use scratch-proof protectors or covers.
- Do not use discs printed with label printers available on the market.

# Simple setup

## STEP 1 Locating

Sheet of speaker feet

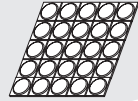

### Use only supplied speakers

Using other speakers can damage the unit and sound quality will be negatively affected.

Set the speakers up on an even surface to prevent them from falling. Take proper precautions to prevent the speakers from falling if you cannot set them up on an even surface.

#### Setup example

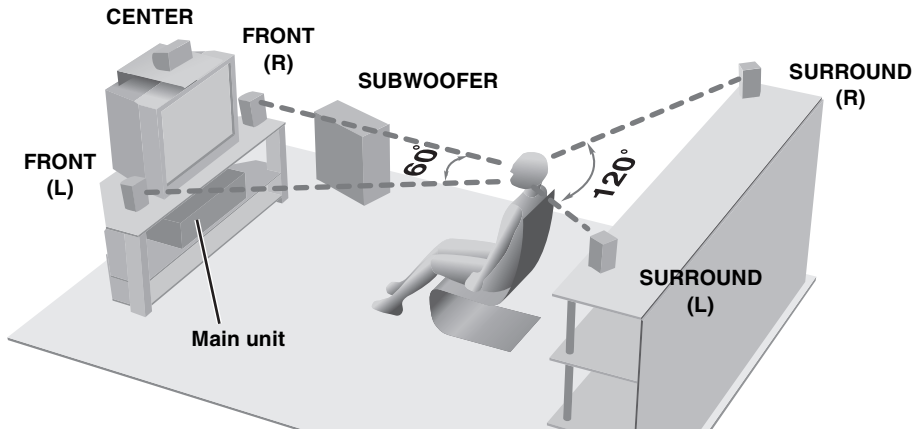

the diagram are

shorten their useful life if you use them for long periods. In some cases to avoid damage.

causing howling from a record player, cassette player, or continuous signals from an electronic instrument. This may affect sound quality. Turn the unit on or off.

### Demagnetizing occurs on your television

The speakers are designed to be used close to a television, but they may be affected with some televisions and setup conditions.

**When this occurs, turn the television off for about 30 minutes.**

The television's demagnetizing function should correct the problem. If the problem persists, move the speakers further away from the television.

- Positioning**
- Place the speakers on a flat surface and the sound will be better.
  - Placing the speakers on a surface with thick carpet and corners can result in a loss of bass.

# STEP 2 Speakers

Sheet of speaker-cord stickers



## 1 Attaching the stickers to the speaker cords

**Attach the stickers to the speaker cords.**

Attach the numbered stickers to the end of the speaker cords so the numbers match the positions of the speakers shown in the diagram.

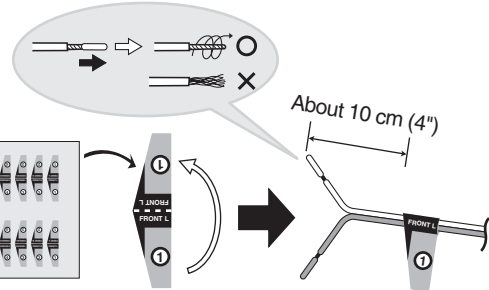

## 2 Connecting the speakers

Connect the cords to the terminals of same color so the numbers on the stickers match the numbers under the terminals.

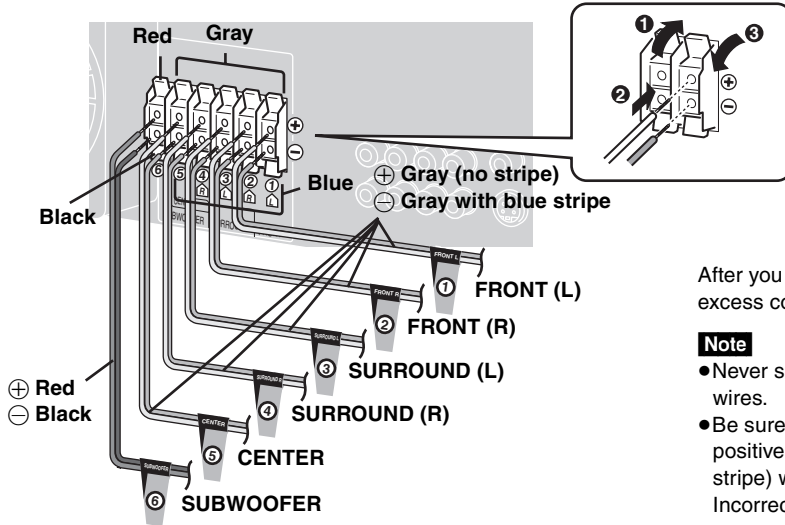

After you have completed setup and connection, wind the excess cord and keep together with string.

### Note

- Never short-circuit positive (+) and negative (-) speaker wires.
- Be sure to connect only positive (red or gray) wires to positive (+) terminals and negative (black or gray with blue stripe) wires to negative (-) terminals. Incorrect connection can damage the speakers.

### Other speaker setup options

#### Attaching to a wall

Attach four speaker feet to each speaker, ensuring they do not cover hole.

- 1 Screw a screw (not included) into the wall.

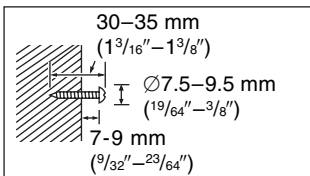

- 2 Fit the speaker securely onto the screw with the hole or holes.

#### Center speaker (SB-PC650)

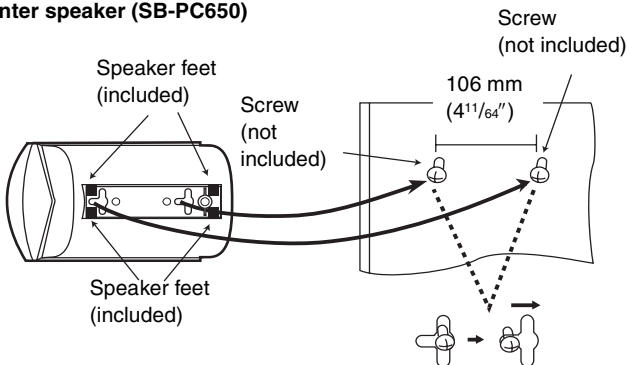

#### Front and Surround speakers (SB-AFC650)

The method for attaching speakers to a wall is the same except that there is only one bracket.

### Note

The wall or pillar on which the speakers are to be attached should be capable of supporting 10 kg (22 lb.) for SB-PC650 and 5 kg (11 lb.) for SB-AFC650 per screw.

#### Fitting speaker stands (optional)

##### Preparation

Ensure the stands meet these conditions before purchasing them.

- Observe the diameter and length of the screws and the distance between screws as shown in the diagram.
- The stands must be able to support over 10 kg (22 lb.) for SB-PC650 and 5 kg (11 lb.) for SB-AFC650.
- The stands must be stable even if the speakers are in a high position.

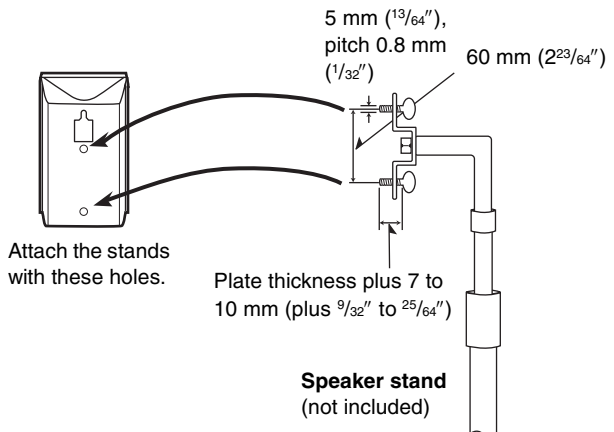

# STEP 3 Television

Simple setup

■ Connecting a television with a VIDEO IN terminal

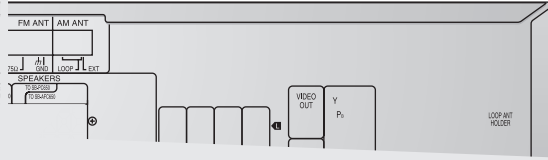

■ Connecting a television with a COMPONENT VIDEO IN terminal



S-video cable (not included)

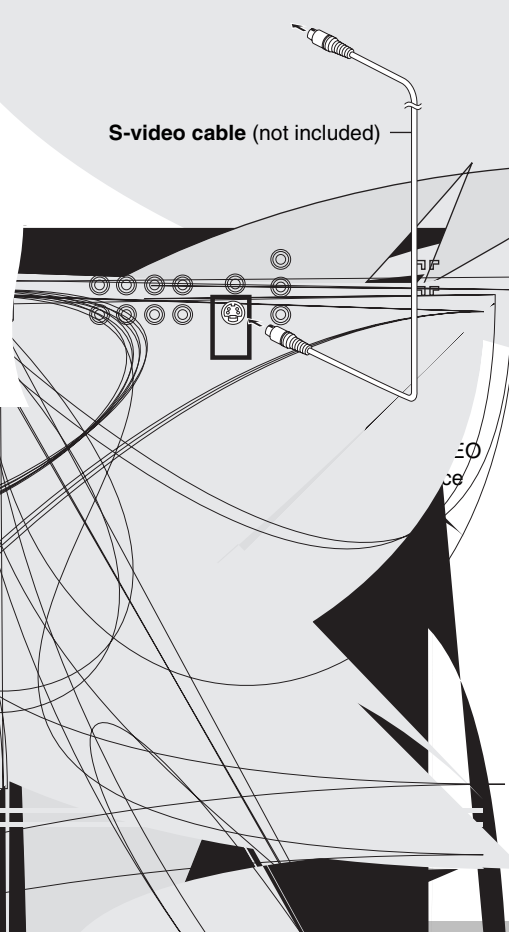

### To enjoy progressive video

- Connect to the component video (480P) input terminals on a television compatible with this unit's copy guard system. (Video will not be displayed correctly if connected to an incompatible television.)
- Press [PROGRESSIVE OUT] on the main unit so "PROGRESSIVE" appears on the display (➔ page 12).
- All televisions manufactured by Panasonic and that have 480P input connectors are compatible. Consult the manufacturer if you have another brand of television.



# STEP 4 Antennas and AC power supply cord

AM loop antenna set    FM indoor antenna    AC power supply cord



Plug in the AC power supply cord after making all connections.

### FM indoor antenna

Fix the other end of the antenna where reception is best.

Adhesive tape

AC power supply cord (included)

To household AC outlet

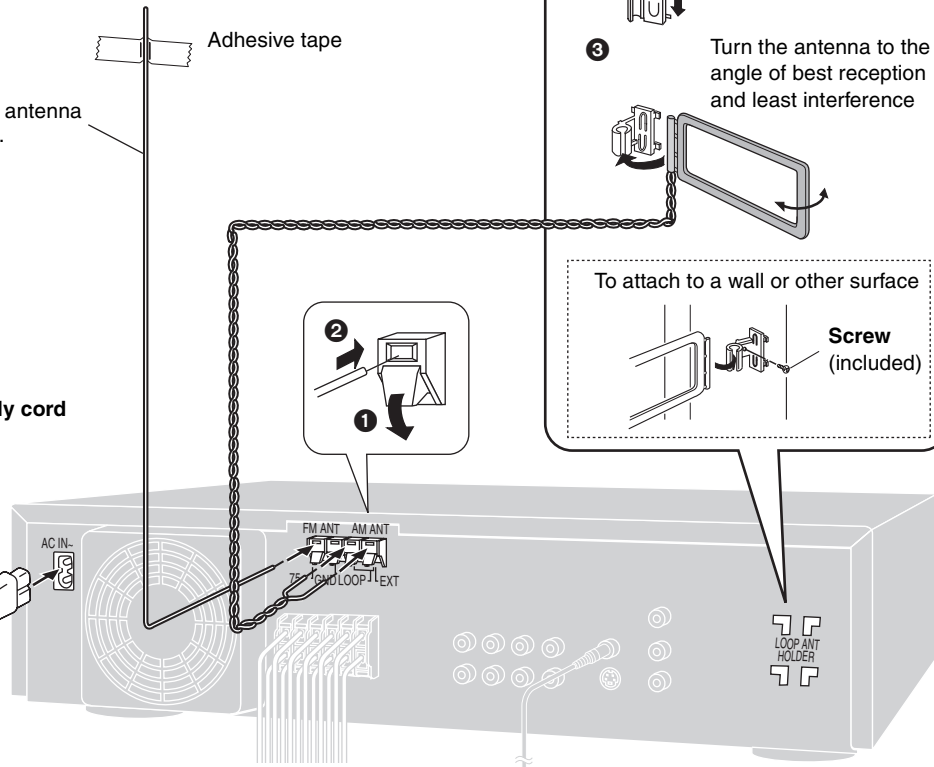

### AM loop antenna

Keep loose antenna cord away from other wires and cords.

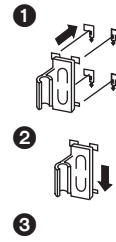

AM loop antenna holder (included)

Turn the antenna to the angle of best reception and least interference

To attach to a wall or other surface

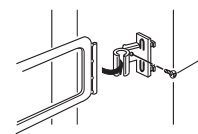

Screw (included)

### Conserving power

The unit consumes power (approx. 0.5 W) even when it is turned off with [D]. To save power when the unit is not to be used for a long time, unplug it from the household AC outlet.

Remember to reset the radio stations and any other memory items before using the unit again.

Information you enter into the unit's memory remains intact for up to 1 week after the AC power supply cord is disconnected.

# STEP 5 The remote control

Remote control

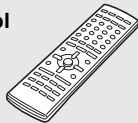

Batteries

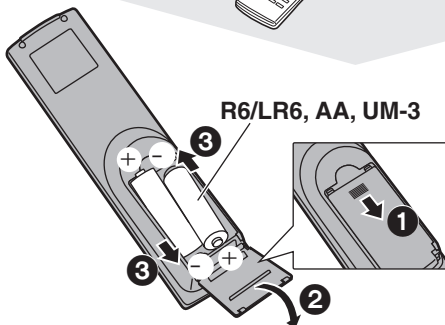

R6/LR6, AA, UM-3

- Insert so the poles (+ and -) match those in the remote control.
- Do not use rechargeable type batteries.

### Do not;

- mix old and new batteries.
  - use different types at the same time.
  - heat or expose to flame.
  - take apart or short circuit.
  - attempt to recharge alkaline or manganese batteries.
  - use batteries if the covering has been peeled off.
- Mishandling of batteries can cause electrolyte leakage which can damage items the fluid contacts and may cause a fire.

Remove if the remote control is not going to be used for a long period of time. Store in a cool, dark place.

### Use

Aim at the sensor, avoiding obstacles, at a maximum range of 7 m (23 feet) directly in front of the unit.

# STEP 6 QUICK SETUP

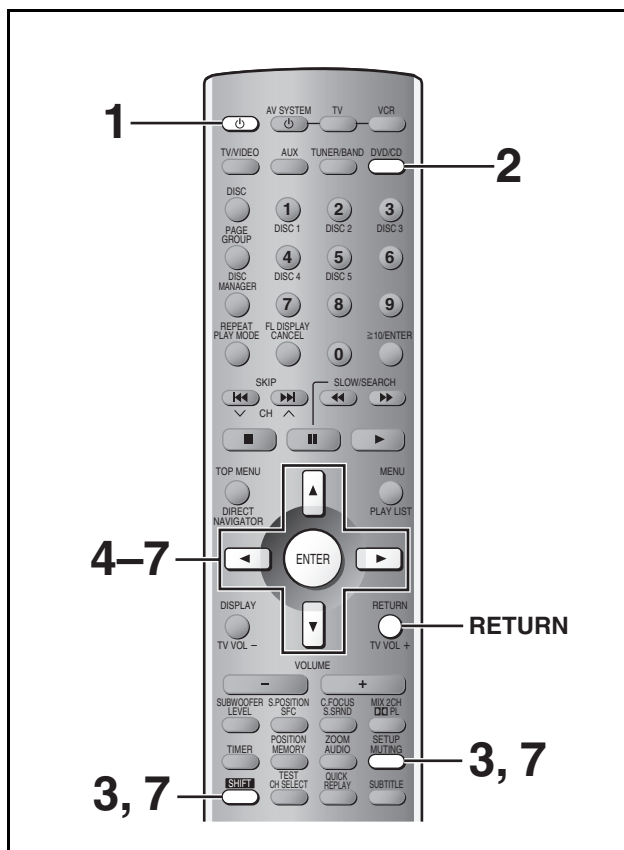

The **QUICK SETUP** screen appears when you press [SHIFT]+[SETUP] the first time after purchase and assists you to make necessary settings. You can access this screen again later if you need to (➔ page 32, Others—QUICK SETUP).

## Preparation

Turn on the television and select the appropriate video input on the television to suit the connections for the unit.

- 1 Press [POWER] to turn on the unit.
- 2 Press [DVD/CD] to select “DVD/CD” as the source.
- 3 Press [SHIFT]+[SETUP] to show the **QUICK SETUP** screen.

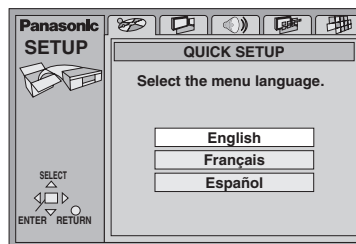

- 4 Press [▲, ▼] to select the menu language and press [ENTER].
- 5 Press [▲, ▼] to select “Yes” to continue and press [ENTER].
- 6 Press [▲, ▼] to select the item and press [ENTER].
  - Audio Language (➔ page 32)
  - Subtitle Language (➔ page 32)
  - TV Type (➔ below)
  - TV Aspect (➔ below)
- 7 Press [ENTER] and then [SHIFT]+[SETUP] to end the settings.

## To return to the previous screen

Press [RETURN].

## ■ TV Type

Select to suit the type of television.

- Standard (Direct View TV) (factory preset)
- CRT Projector
- LCD TV/Projector
- Projection TV
- Plasma TV

## ■ TV Aspect

Select “4:3” (regular) or “16:9” (widescreen) to suit your television.

If you have a regular 4:3 television, you can also select how video on some discs is shown (➔ page 32, Video—TV Aspect).

- 4:3 Pan&Scan (factory preset)  
Widescreen software is expanded to fill the screen of a 4:3 aspect television (unless prohibited by the producer of the disc).
- 4:3 Letterbox  
Widescreen software is shown in the letterbox style on a 4:3 aspect television.



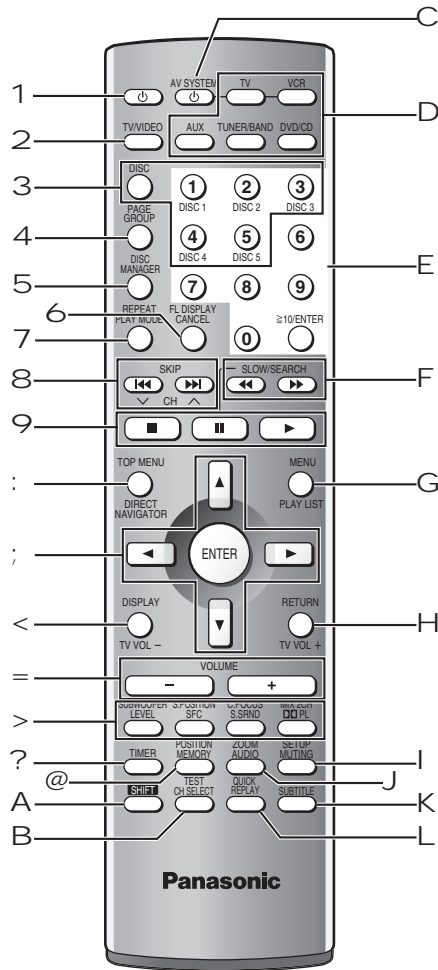

## Remote control

- ① Standby/on switch [POWER  $\phi$ /I] . . . . . 10
- ② TV/VIDEO button [TV/VIDEO] . . . . . 30
- ③ Disc select button [DISC], Disc buttons [DISC1]–[DISC5] . . 12
- ④ Group, Page button [GROUP, PAGE] . . . . . 14, 15
- ⑤ Disc manager button [DISC MANAGER] . . . . . 13
- ⑥ Cancel, FL display button [CANCEL, FL DISPLAY] . . . . 17, 29
- ⑦ Play mode, Repeat button [PLAY MODE, REPEAT] . . . . 15, 17
- ⑧ Skip, Preset channel, TV channel button  
[|◀◀ ▶▶|, SKIP,  $\nabla$  CH  $\wedge$ ] . . . . . 14, 25, 30
- ⑨ Basic operation buttons . . . . . 12
- ⑩ Top menu, Direct navigator button  
[TOP MENU, DIRECT NAVIGATOR] . . . . . 12, 19
- ⑪ Cursor buttons [ $\blacktriangle$ ,  $\blacktriangledown$ ,  $\blacktriangleleft$ ,  $\blacktriangleright$ ], Enter button [ENTER] . . . . 10
- ⑫ Display, TV volume down button [DISPLAY, TV VOL–] . . 22, 30
- ⑬ Volume buttons [–, +, VOLUME] . . . . . 12
- ⑭ Sound field, sound quality buttons . . . . . 26–28
- ⑮ Timer button [TIMER] . . . . . 29
- ⑯ Position memory button [POSITION MEMORY] . . . . . 13
- ⑰ Shift button [SHIFT]  
To use functions labeled in orange:  
While pressing [SHIFT], press the corresponding button.
- ⑱ Channel select, Test button [CH SELECT, TEST] . . . . . 26
- ⑲ AV system standby/on button [ $\phi$ , AV SYSTEM] . . . . . 30
- ⑳ Source select buttons  
Face towards this unit to change the source.  
Press [TV] or [VCR] first to operate a Panasonic television or  
video cassette recorder (➔ pages 30, 31).
- ㉑ Numbered buttons [1–9, 0,  $\cong$ 10/ENTER] . . . . . 14
- ㉒ Slow/search button [ $\blacktriangleleft$ ,  $\blacktriangleright$  SLOW/SEARCH] . . . . . 14
- ㉓ Menu, Play list button [MENU, PLAY LIST] . . . . . 12, 19
- ㉔ Return, TV volume up button [RETURN, TV VOL+] . . . 10, 30
- ㉕ Muting, Setup button [MUTING, SETUP] . . . . . 10, 29
- ㉖ Audio, Zoom button [AUDIO, ZOOM] . . . . . 16, 18
- ㉗ Subtitle button [SUBTITLE] . . . . . 16
- ㉘ Quick replay button [QUICK REPLAY] . . . . . 14

## Main unit

- ① Standby/on switch [POWER  $\phi$ /I] . . . . . 10  
Press to switch the unit from on to standby mode or vice versa.  
In standby mode, the unit is still consuming a small amount of power.
- ⑲ AC supply indicator [AC IN]  
This indicator lights when the unit is connected to the AC mains  
supply.
- ⑳ Disc select buttons/indicators [DISC 1–5] . . . . . 12
- ㉑ Wake timer indicator [WAKE] . . . . . 29
- ㉒ Display
- ㉓ Stop, Tune mode button [ $\blacksquare$ , TUNE MODE] . . . . . 12, 25
- ㉔ Pause, FM mode button [ $\parallel$ , FM MODE] . . . . . 12, 25
- ㉕ Progressive out button [PROGRESSIVE OUT] . . . . . 12
- ㉖ Sound field control button [SFC] . . . . . 27
- ㉗ Subwoofer level button [SUBWOOFER LEVEL] . . . . . 28
- ㉘ Volume control [VOLUME, DOWN, UP] . . . . . 12
- ㉙ Disc tray . . . . . 12
- ㉚ Open/close button [ $\blacktriangle$ , OPEN/CLOSE] . . . . . 12
- ㉛ Play, Memory button [ $\blacktriangleright$ , MEMORY] . . . . . 12, 25
- ㉜ Skip/search, Tuning buttons  
[|◀◀/▶▶|,  $\nabla$  TUNING  $\wedge$ ] . . . . . 14, 25
- ㉝ Headphone jack [PHONES] . . . . . 29
- ㉞ Remote control signal sensor
- ㉟ Source select button [SELECTOR] . . . . . 25

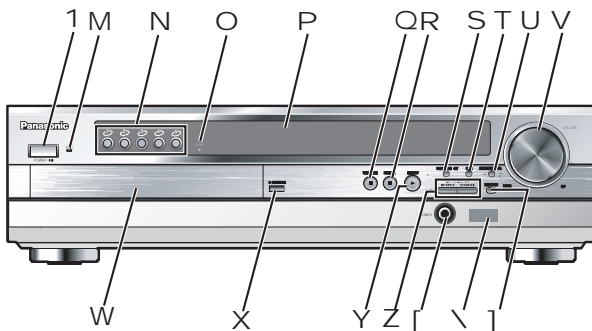



RAM DVD-A DVD-V VCD CD WMA MP3 JPEG

#### Preparation

- Press [⏻] to turn on the unit.
- Turn on the television and select the appropriate video input on the television to suit the connections for the unit.

### 1 Press [DVD/CD] to select “DVD/CD” as the source.

#### To enjoy progressive video

Press [PROGRESSIVE OUT].

The television will be disrupted for a moment but this is normal.

- Output from this unit is interlace if you have connected to the television through the VIDEO OUT or S-VIDEO OUT or playing PAL discs, even if “PROGRESSIVE” is on the display.
- When progressive output is on, closed captions will not be displayed.

### 2 Press [DISC] and then ([DISC 1]–[DISC 5]).

The indicator on the main unit lights.

Play starts if a disc is in the tray.

**Main unit:** Press [DISC 1]–[DISC 5].

### 3 Press [▲] to open the disc tray and place the disc.

- Remove TYPE 2 and 4 discs from their cartridges before use. **RAM**

- Label-up (With double-sided discs, load so the label for the side you want to play is facing up.)

### 4 Press [▲] to close the disc tray.

If the disc contains both audio data (WMA and MP3) and JPEG, check “Mixed Disc—Audio & Stills” setting in the SETUP menu (→ page 32). Select “Stills (JPEG)” or “Audio (MP3/WMA)”.

### 5 Press [▶] (play).

Play begins.

**WMA** **MP3** **CD** (CD text only)

Group and track names are displayed on the television.

- Press [SUBTITLE] to turn the display on or off.
- You can also use the navigation menus to control play (→ page 20).

### 6 Adjust the volume.

(Minimum) (Maximum)

#### ■ To pause play

Press [II] during play.

Press [▶] (play) to restart play.

#### ■ To stop play

Press [■] (→ page 13, Resume function).

#### Note

- If “⊘” appears on the television

The operation is prohibited by the unit or disc.

- It may take some time for play to start but this is normal.

**DVD-A** **DVD-V** **VCD**

### Press the numbered buttons to select an item.

#### To select a 2-digit number

Example: To select item 23, press [≥10] → [2] → [3].

- When playing DVDs, you can also use [▲, ▼, ◀, ▶] to select items. Press [ENTER] to confirm your selection.

#### To return to the menu screen

**DVD-A** **DVD-V** [TOP MENU]: Shows the first menu screen.

**DVD-V** [MENU]: Shows the menu screen.

**VCD** [RETURN]: Shows the menu screen.

#### Note

The disc continues to rotate while the menu is displayed even after you finish playing an item. Press [■] when you finish to preserve the unit's motor and your television screen.

## Using the disc manager

VCD CD

The disc manager allows you to choose one track or disc to play or to play all five discs in succession.

### 1 While stopped

#### Press [DISC MANAGER] to select the desired method.

Each time you press the button:

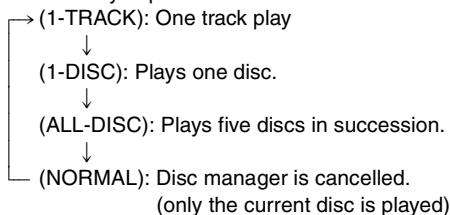

### 2 Select the disc and track.

- When selecting “1-DISC”, press [DISC] and [1]–[5].
- When selecting “1-TRACK”, press the numbered buttons.  
To select a 2-digit number  
Example: To select track 23: press [ $\geq 10$ ] → [2] → [3].  
You can also select the track by pressing [◀◀] and [▶▶].

### 3 Press [▶] (play).

#### To cancel disc manager

Press [■].

#### To play a track or disc repeatedly

Press [SHIFT]+[REPEAT] during disc manager play (→ page 15).

#### Note

- You cannot use the disc manager while “RANDOM” or “PRGM” are on.
- When playing video CDs with playback control in the “1-DISC” or “ALL DISC” mode, you can play the disc without having to operate the disc’s menus.
- The disc manager skips any DVD and WMA/MP3/JPEG discs that are loaded.

## Position Memory function

RAM DVD-A DVD-V VCD CD WMA MP3 JPEG

During play

### Press [POSITION MEMORY] to memorize a position.

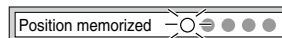

Press again to replace the position.

This position is saved even if you turn the unit off, change the source or change discs. When you turn the unit on, reselect “DVD/CD” or reinsert the disc whose position you memorized, “RESUME” lights on the display. Press [▶] (play) to start play from the memorized position. The position is cleared.

- You can memorize positions on up to five different discs at a time. When you memorize another position, the earliest position is replaced.
- This function does not work when using Disc manager.

#### Resume function

“RESUME” lights on the display when the unit has recorded the position at which you stopped play.

Press [▶] (play) to start play from that position.

- The position is cleared when you:
  - Turn the unit off.
  - Select another source or change discs.
- Press [■] to clear the position.

#### Chapter Preview

#### DVD-V

The following message appears immediately after you press [▶] (play) when “RESUME” is displayed.

Press [▶] (play) while the message is displayed and the beginning portions of each chapter up to the current one are played.

Full play resumes from the point where you pressed [■] or [POSITION MEMORY].

(This feature works only within a title.)

If you do not press [▶] (play), the message disappears and play starts from where you pressed [■] or [POSITION MEMORY].

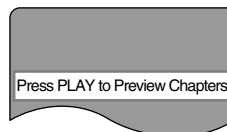

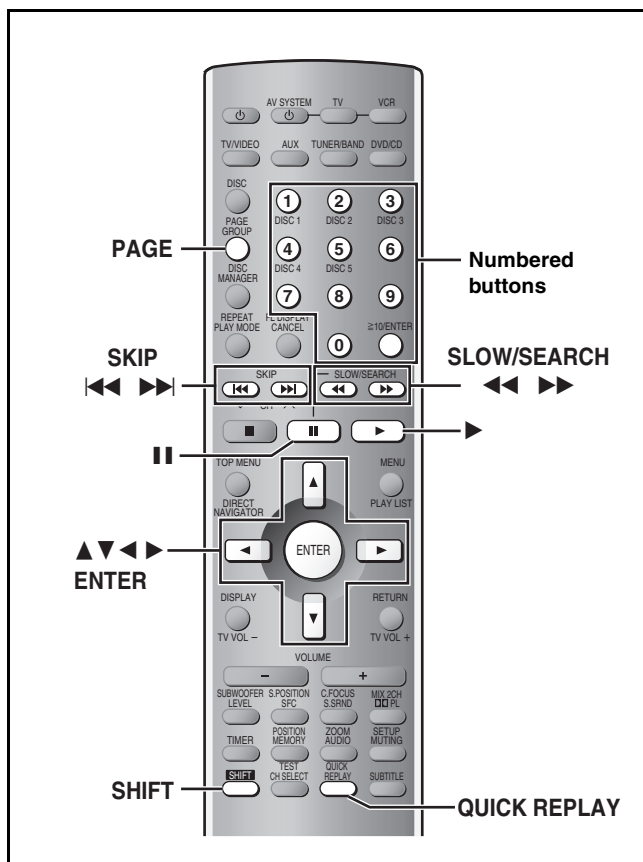

## Replaying a scene—QUICK REPLAY

RAM DVD-A DVD-V VCD CD WMA MP3

Skip back a few seconds within the current item (program, track or title).

JPEG

Skip back a few pictures.

During play

Press [QUICK REPLAY].

### Note

This feature may not work while playing some parts of a disc or at all with some discs.

## Starting play from a selected item

RAM DVD-A DVD-V VCD CD WMA MP3 JPEG

Press the numbered buttons to select the item.

Play starts from the selected item.

To select a 2-digit number

Example: To select track 23, press [ $\geq 10$ ]  $\Rightarrow$  [2]  $\Rightarrow$  [3].

WMA MP3 JPEG [2]  $\Rightarrow$  [3]  $\Rightarrow$  [ENTER]

### Note

- This works only when stopped with some discs.
- When playing DVD-Audio and you want to start play from a track in a different group, select the group first ( $\Rightarrow$  page 15).

## Selecting still pictures—Page Skip

DVD-A

During play or while paused

Press [SHIFT]+[PAGE].

The page changes each time you press the button.

PAGE 1

## Skipping items

RAM DVD-A DVD-V VCD CD WMA MP3

During play or while paused

Press [ $\lll$ ] or [ $\ggg$ ].

- Press [ $\lll/\lll$ ] or [ $\ggg/\ggg$ ] on the main unit.

JPEG

Press [ $\ll$ ] or [ $\gg$ ] for picture skip, or [ $\blacktriangle$ ] or [ $\blacktriangledown$ ] for group skip.

- Each press increases the number of skips.

Example RAM

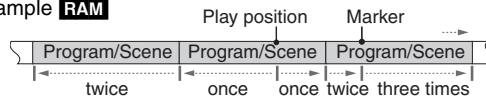

## Fast forward and rewind—SEARCH

RAM DVD-A DVD-V VCD CD WMA MP3

During play

Press [ $\lll$ ] or [ $\ggg$ ].

- Press and hold [ $\lll/\lll$ ] or [ $\ggg/\ggg$ ] on the main unit.
- Audio will be heard during search for most discs. You can turn this audio off if you want to ( $\Rightarrow$  page 32, Audio—Audio during Search).
- DVD-V You can slow down or speed up play ( $\Rightarrow$  page 22).

## Slow-motion play

RAM DVD-V VCD

DVD-A (Motion picture parts only)

While paused

Press [ $\lll$ ] or [ $\ggg$ ].

- Press and hold [ $\lll/\lll$ ] or [ $\ggg/\ggg$ ] on the main unit.

## Frame-by-frame viewing

RAM DVD-V VCD

DVD-A (Motion picture parts only)

While paused

Press [ $\ll$ ] or [ $\gg$ ].

The frame changes each time you press the button.

- The frames change in succession if you press and hold the button.
- Pressing [II] also activates forward frame-by-frame.

### Notes

- The speed of search and slow-motion increases up to 5 steps.
- Press [▶] (play) to restart play.
- You cannot move backwards with Video CD during frame-by-frame and slow-motion.

### When playing Video CDs with playback control

Pressing buttons to perform skip, search or slow-motion may take you to a menu screen.

Each time you press the button:

**RAM**

PG REPEAT → ALL REPEAT (Entire disc) → REPEAT OFF

• During play list play

SCENE REPEAT → PL REPEAT → REPEAT OFF

**DVD-V**

CHAPTER REPEAT → TITLE REPEAT → REPEAT OFF

**VCD CD**

You can repeat tracks as follows depending on the Disc Manager setting (→ page 13).

1-TRACK → 1-DISC → ALL-DISC → NORMAL



**DVD-A WMA MP3**

TRACK REPEAT

**Repeat tracks/chapters**

Start program... and press [SHIFT]+[REPEAT] to select the re...

**A-B Repeat**

You can repeat a section between points A and B within a program, track.

During play

**1 Press [GROUP].**

Example **MP3**

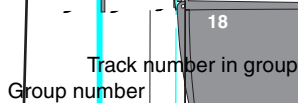

**2 Press the numbered button of the group and press [ENTER].**

**3 Press the numbered button of the track/picture number [ENTER].**

**DVD-A**

Playing all the groups in succession (→ page 17, All)

**Playing bonus groups**

Some discs contain bonus groups. If a password screen appears after selecting a group, enter the password with the numbered buttons. Refer also to the disc's jacket.

**RAM DVD-A DVD-V MPEG**

**VCD CD WMA MP3** (There is no on-screen display.)

During play

Press [GROUP]

Example **RAM**

[REPEAT] until the unit screen is displayed

to select the play menu.



A-B Repeat

[REPEAT] to select "A-B Repeat" and [ENTER] at the starting point

press [ENTER] at the finishing point (B).



npe7t ct 7t ]

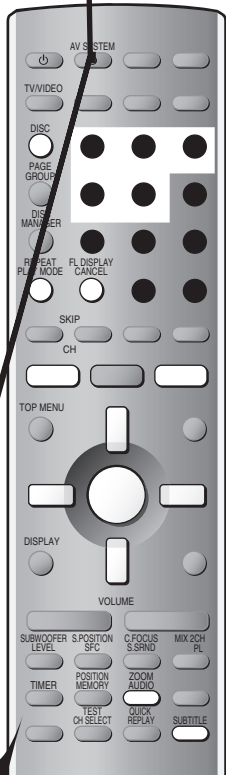

**Signal type/data**

LPCM/PPCM/□□□ Digital/DTS: Signal type

k (kHz): Sampling frequency

b (bit): Number of bits ch (channel): Number of channels

Example:

3/2 .1ch

**DVD-A** (Motion picture parts only)

**DVD-V VCD** (SVCD only)

You can change the subtitle language and turn the subtitles on and off.

**RAM**

You can turn the subtitles on and off.

**During play**

**Press [SUBTITLE].**

The number changes each time you press the button.

**AUDIO**  
**SUBTITLE**

ved instead of the language number in  
n as when no language is recorded.

title numbers may change depending  
recorded.

...gua  
...used  
...rn the  
...the sub  
...[SUBTITLE].  
...[DVD-A  
...[▲, ▼] to  
...changing  
...subtitles



## Common procedures for all group, program and random play

### While stopped

Press [PLAY MODE].

Each time you press the button:

#### DVD-A

All group → Program → Random → off (Normal play)

#### VCD CD

PRGM → RANDOM → RANDOM ALLDISC → off (Normal play)

#### DVD-A

If you select bonus groups, you will have to enter a password (→ page 15).

## All group play

### DVD-A

The unit plays tracks in all the groups on a disc.

Press [▶] (play).

## Program play

You can select up to 24 items to play in the order you choose.

VCD CD (There is no on-screen display.)

You can program all the items on discs.

### DVD-A

You can program all the items on a disc in the play position.

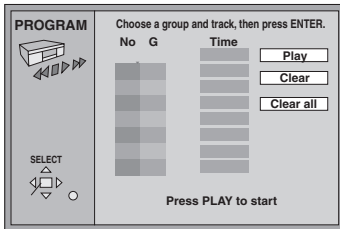

1 VCD CD

Press the [DISC] and then the disc button ([DISC 1]–[DISC 5]).

2 Press the numbered buttons to select a group or track.

#### • To select a 2-digit number

Example: To select item 25, press [≥10] → [2] → [5].

• Repeat steps 1 and 2 to program other items.

#### • VCD CD

Step 1 is unnecessary when programming tracks on the same disc.

#### • DVD-A

To select an item using the cursor buttons

Press [ENTER] and [▲, ▼] to select an item, then press [ENTER] again to register the number.

All the items in the selected disc or group are selected when you select “ALL”.

## 3 Press [▶] (play).

To add or change the program

VCD CD (Add only)

Repeat steps 1 and 2.

#### DVD-A

Press [▲, ▼] to select an available item, then repeat step 2.

To clear an item

VCD CD

Press [CANCEL].

#### DVD-A

1 Select the item you want to clear with [▲, ▼].

2 Press [CANCEL], or select “Clear” with [▲, ▼, ◀, ▶] and press [ENTER].

To clear the whole program

VCD CD

Press [■] so “CLEAR” is displayed.

#### DVD-A

Select “Clear all” with [▲, ▼, ◀, ▶] and press [ENTER].

#### Note

#### • VCD CD

Items the unit cannot find can be programmed but are canceled during play. This is also the case if you program DVD-RAM, DVD-Audio, DVD-Video, WMA, MP3 and JPEG.

#### • DVD-A

The program is cleared when you switch the unit to standby, select another source, exit the program mode by pressing [PLAY MODE] or open the disc tray.

VCD CD

The program is retained in memory.

VCD CD (There is no on-screen display.)

RANDOM: You can play a disc in the play position in random order.

RANDOM ALLDISC: You can play all discs in random order.

#### DVD-A

You can play items on a disc in the play position in random order.

1 DVD-A

Press the numbered buttons to select a group.

#### DVD-A

• You can select more than one group.

• To enter all groups, select “All” using [◀, ▶] and press [ENTER].

• To deselect a group, press the numbered buttons corresponding to the group you want to clear.

## 2 Press [▶] (play).

#### Note

VCD CD

During random play, empty trays are skipped and the playback control function on Video CDs is canceled.



## Marking places to play again

**RAM** **DVD-A** **DVD-V** **VCD** **CD** **WMA** **MP3** **JPEG**

You can mark a position so you can return to it easily at a later time.

- 1 **During play**  
Press **[DISPLAY]** until the unit information screen is displayed (⇒ page 23).
- 2 Press **[▲, ▼]** to select the play menu.
- 3 Press **[◀, ▶]** to select “Marker” and press **[ENTER]**.  
**RAM**  
Press **[▶]** to select an asterisk (\*).
- 4 Press **[ENTER]** at the point you want to mark.

### To mark another position

Up to 5 points (**RAM** only: up to 999 points)

- 1 Press **[▶]** to select “\*”.
- 2 Press **[ENTER]** at the point.

### To recall or erase a marker

- 1 Press **[◀, ▶]** to select a marker.
- 2 Press **[ENTER]** to recall or press **[CANCEL]** to erase.

### **RAM**

#### To mark the eleventh point and beyond

- 1 Press **[◀, ▶]** to select the marker pin icon.
- 2 Press **[▲, ▼]** to select “11–20”.  
You can select the next group when the current group is full.

### **Note**

Markers added with this unit clear when you switch the unit to standby, change the source, or change the disc.

**RAM** **DVD-V** **VCD**

**DVD-A** (Motion picture parts only)

Change the zoom ratio so the picture expands to the optimum size to fill the screen.

### Preparation

Change the setting “TV Aspect” to suit your television (⇒ page 32).

### During play

Press **[SHIFT]+[ZOOM]** to select the aspect ratio.

Each time you press the button:

**4:3 Standard** → **European Vista** → **16:9 Standard**

↑  
**Cinemascope2** ← **Cinemascope1** ← **American Vista**  
↓

- Refer to the disc’s instructions and “Screen size” below for the aspect ratio of the picture.

### To restore the original ratio

Press **[SHIFT]+[ZOOM]** until the ratio returns to 1.00.

- The ratio also returns to 1.00 when you change the disc, change the source or switch the unit to standby.
- The ratio may return to 1.00 when a menu is displayed.

### Making fine adjustments to the zoom ratio

While the ZOOM icon is displayed

Press **[▲, ▼]**.

The ratio changes in 0.01 units between 1.00 and 1.60 and in 0.02 units between 1.60 and 2.00.

### ■ Screen size

Movies are made using a variety of screen sizes.

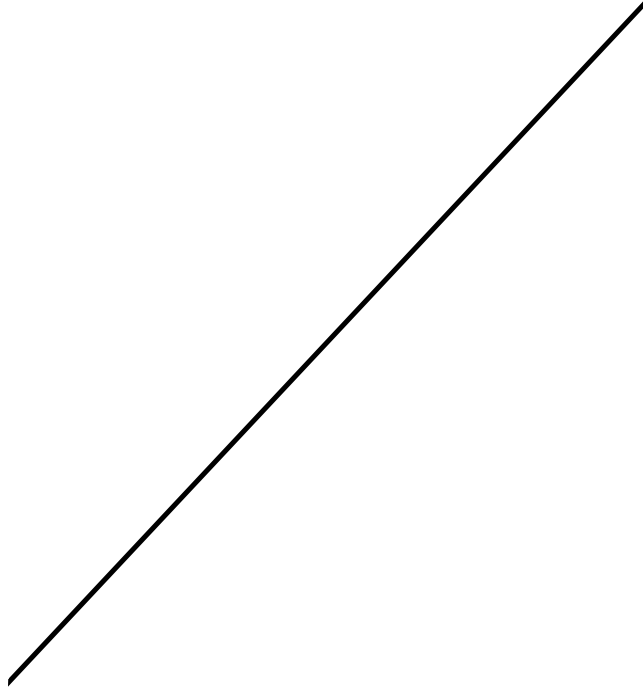

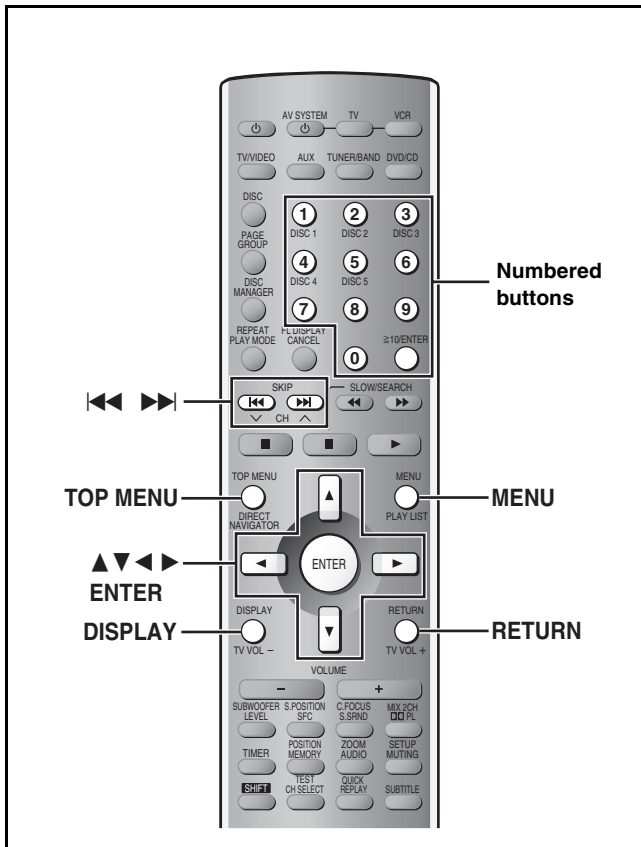

If the disc contains both audio data (WMA and MP3) and JPEG, check “Mixed Disc—Audio & Stills” setting in the SETUP menu (➔ page 32). Select “Stills (JPEG)” or “Audio (MP3/WMA)”.

**WMA** **MP3** **CD** (CD text only) **JPEG**

Various menus help you find items you want to start play.

## 1 Press [TOP MENU].

**WMA** **MP3** Audio navigation menu

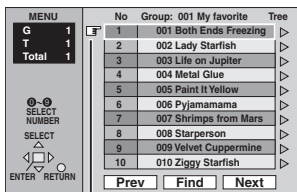

**JPEG** Album display

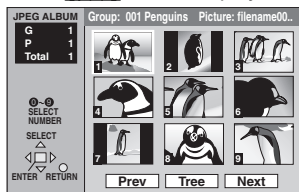

“” indicates the track currently playing.

## 2 Press [▲, ▼] to select a track or [▲, ▼, ◀, ▶] to select a picture, and press [ENTER].

To show other pages, press [▲, ▼, ◀, ▶] to select “Prev” or “Next” and press [ENTER].

- After listing all the tracks or pictures in one group, the list for the next group appears.

**To exit to the menu**  
Press [TOP MENU].

**Track title search** **WMA** **MP3** **CD** (CD text only)

Example: finding a track including the word “LOVE”

### 1 While the menu is displayed

Press [▲, ▼] to select “Find” and press [ENTER].

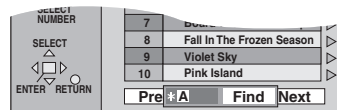

### 2 Press [▲, ▼] to select “L” and press [ENTER].

Characters change in alphanumeric order each time you press [▲].

Repeat this step to enter “O”, “V”, and “E”.

- Press [◀, ▶] to skip between A, E, I, O, and U.
- Only uppercase appear but the search also includes lower case.
- Press [◀] to erase a character.
- You can erase the asterisk (\*) to search for the first word in a title.
- You can enter numbers with the numbered buttons.

### 3 Press [▶] to select “Find” and press [ENTER].

The search results screen appears.

### 4 Press [▲, ▼] to select the track and press [ENTER].

**To return to the menu**

Press [RETURN].

**To use the tree screen to find a group** **WMA** **MP3** **JPEG**

### 1 While the menu is displayed

Press [▶] while a track is highlighted to display a tree screen.

Press [▲, ▼, ◀, ▶] to select “Tree” and press [ENTER].

Example **MP3**

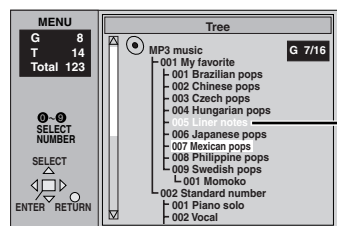

### 2 Press [▲, ▼, ◀, ▶] to select a group and press [ENTER].

The audio navigation menu/album display for the group appears.

**To return to the menu**

Press [RETURN].

## To use the contents screen to find a track

**CD** (CD text only)

You can use the text information recorded on these discs to find a track to play.

- 1 While the menu is displayed  
Press [**▶**] while a track is highlighted to display the contents screen.

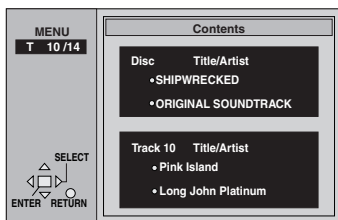

- 2 Press [**◀**, **▶**] to move through the tracks and press [**ENTER**].

### To return to the menu

Press [**RETURN**].

See page 35 for details about WMA, MP3, CD text and JPEG.

## Playing HighMAT discs

A menu appears when you select the disc.

Press [**▲**, **▼**, **◀**, **▶**] to select then press [**ENTER**].

When you press [**ENTER**]:

Menu: Takes you to the next menu which shows play lists or another menu

Play list: play starts

- To return to the menu screen  
Press [**TOP MENU**].
- To return to the menu above the current one  
Press [**RETURN**].
- To change the menu background  
Press [**DISPLAY**].  
The background changes to the one recorded on the disc.

### Selecting from the lists

- 1 During playing  
Press [**MENU**].

- 2 Press [**◀**] then [**▲**, **▼**] to switch between the play list, group and content lists.
- 3 Press [**▶**] then [**▲**, **▼**] to select an item and press [**ENTER**].

### To exit the list screen

Press [**MENU**].

HighMAT and the HighMAT logo are



Unless otherwise indicated, select items with [◀, ▶] and change with [▲, ▼].

## Disc information

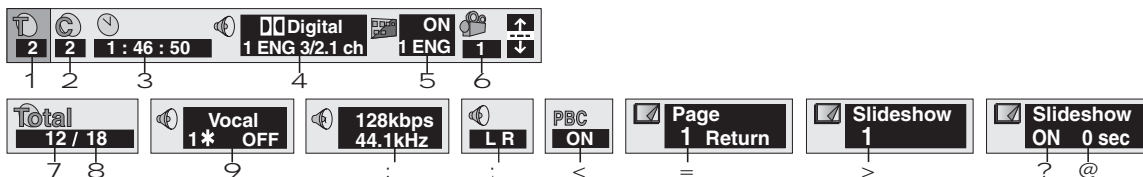

①	PG: Program number <b>RAM</b> PL: Play list number <b>RAM</b> G: Group number <b>DVD-A WMA MP3 JPEG</b> T: Title number <b>DVD-V</b> Track number <b>VCD CD</b>	[▲, ▼] ↓ [ENTER]
②	T: Track number in group <b>DVD-A WMA MP3</b> C: Chapter number <b>DVD-V</b> P: Picture number <b>JPEG</b>	[ENTER]
③	<b>Time RAM DVD-A DVD-V</b> Select a position to start play by specifying a time.  <b>Changing the time display</b> <b>RAM DVD-A DVD-V VCD CD</b> <b>[VCD (SVCD only) WMA MP3 Display only]</b> →Elapsed play time for the program, play list, title or track ↓ ↑ Remaining time for the group ( <b>DVD-A</b> ) or disc ( <b>VCD CD</b> ) ↓ ↑ Remaining time for the program, play list, title or track	Numbered buttons ↓ [ENTER]
④	<b>Soundtrack DVD-A DVD-V</b> (⇒ page 16) Refer to "Audio/Subtitle language" (⇒ right) for language abbreviations.	
⑤	<b>Subtitle language DVD-A DVD-V VCD</b> (SVCD only) (⇒ page 16) Refer to "Audio/Subtitle language" (⇒ right) for language abbreviations. <b>Subtitles on/off RAM DVD-A DVD-V VCD</b> (SVCD only) <b>Track information on/off WMA MP3 CD</b> (CD text only) <b>Picture data JPEG</b> Full: Group title, picture title, picture size, file size, date of shooting, and camera model used.* Date: Date of shooting only. OFF: No display *Displays differ depending on the type of camera and condition of the data.	

⑥	<b>Angle number DVD-A DVD-V</b> <b>Picture rotation JPEG</b> 0↔90↔180↔270 ↑ ↓	
⑦	<b>Track/picture number in disc</b> <b>WMA MP3 JPEG</b>	[▲, ▼] ↓ [ENTER]
⑧	<b>Total number of tracks/pictures on disc</b> <b>WMA MP3 JPEG</b>	Display only
⑨	<b>Karaoke vocal on/off DVD-V</b> (Karaoke DVD only) If a DVD title is a duet, select V1 or V2 to duet with the unit.	
⑩	<b>Current bitrate (kbps)</b> <b>Current sampling frequency (kHz)</b> <b>WMA MP3</b>	Display only
⑪	<b>Audio mode RAM VCD</b> LR↔L↔R ↑ ↓	
⑫	<b>Menu play</b> <b>VCD</b> (with playback control only)	Display only
⑬	<b>Still picture number DVD-A</b> ●To return to page 1 [◀, ▶]→Select "Return"→[ENTER]	
⑭	<b>Slideshow DVD-A</b> Picture number	Display only
⑮	<b>Slideshow setting JPEG</b> ON↔OFF	
⑯	<b>Slideshow timing JPEG</b> 0 sec–30 sec	

### Audio/Subtitle language

ENG: English	SVE: Swedish	CHI: Chinese
FRA: French	NOR: Norwegian	KOR: Korean
DEU: German	DAN: Danish	MAL: Malay
ITA: Italian	POR: Portuguese	VIE: Vietnamese
ESP: Spanish	RUS: Russian	THA: Thai
NLD: Dutch	JPN: Japanese	*: Others

## Unit information

### Play menu

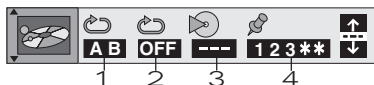

①	<b>A-B repeat</b> (⇒ page 15) <b>RAM DVD-A DVD-V VCD CD WMA MP3</b>	[ENTER]
②	<b>Repeat mode</b> (⇒ page 15) <b>RAM DVD-A DVD-V JPEG</b>	
③	<b>Play mode</b> (⇒ page 17) <b>DVD-A</b> ---: Normal play PGM: Program play RND: Random play ALL: All group play	Display only
④	<b>Marker</b> <b>RAM DVD-A DVD-V VCD CD WMA MP3</b> <b>JPEG</b>	⇒ Page 18

### Audio menu

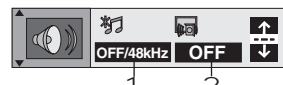

①	<b>Double re-master</b> (⇒ page 28) <b>RAM DVD-A DVD-V CD WMA MP3</b>	
②	<b>Dialogue Enhancer on/off DVD-V</b> (Discs where the dialogue is recorded in the center channel) This makes the dialogue in movies easier to hear.	





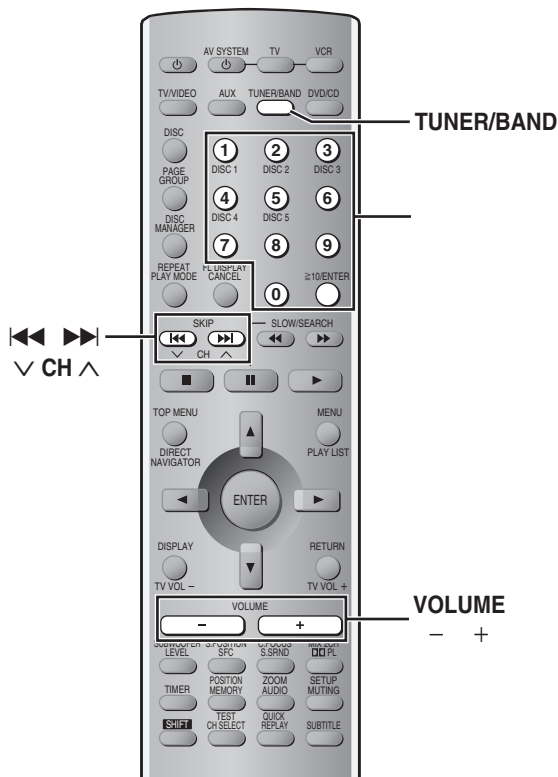

## Manual tuning

### 1 Press [SELECTOR] to select “FM” or “AM”.

Each time you press the button:  
DVD/CD → FM → AM → TV → VCR → AUX

•Remote control: Press [TUNER/BAND].

### 2 Press [TUNE MODE] to select “MANUAL”.

Each time you press the button: MANUAL ↔ PRESET

### 3 Press [∇ TUNING] or [TUNING ∧] to select the frequency of the required station.

TUNED: Displayed when a radio station is tuned.

STEREO: Displayed when a stereo FM broadcast is being received.

Press and hold [∇ TUNING] or [TUNING ∧] until the frequency starts scrolling to start automatic tuning. Tuning stops when a station is found.

### 4 Adjust the volume.

#### ■ If noise is excessive in FM

Press [FM MODE] to display “MONO”.

Press [FM MODE] again to cancel the mode. The mode is also canceled when you changed the frequency.

#### ■ FM frequency step

The step is factory-set to 0.2 MHz, but you can change it to receive broadcasts allocated 0.1-MHz steps.

1 Press [SELECTOR] to select “FM”.

2 Press and hold [SELECTOR].

After a few seconds the display changes to show the current minimum frequency. Continue to hold the button down. The minimum frequency changes and the step is changed.

To return to the original step, repeat the above steps.

#### Note

Any FM/AM frequencies preset in channels will be changed by this procedure. Preset them again.

Preset channels to make selection simple.

Up to 12 stations can each be set in the FM and AM bands.

### 1 Tune to “FM 87.9 MHz” or “FM 87.5 MHz” (⇒ left).

### 2 Press and hold [MEMORY].

The FM stations the unit can receive are preset.

### 3 Tune to “AM 520 kHz”.

### 4 Press and hold [MEMORY].

The AM stations the unit can receive are preset.

The last station to be preset is displayed when presetting finishes.

### 1 Tune to the station (⇒ left).

### 2 Press [MEMORY] twice.

### 3 Press [∇ TUNING] or [TUNING ∧] to select a channel.

### 4 Press [MEMORY].

The station occupying a channel is erased if another station is preset in that channel.

### 1 Press [TUNER/BAND] to select “FM” or “AM”.

•Main unit: Press [SELECTOR].

### 2 Press the numbered buttons or [∣◀◀, ∇ CH] or [▶▶∣, CH ∧] to select the channel.

#### To select a 2-digit number

Example: To select channel 12, press [≥10] ⇒ [1] ⇒ [2]

•Main unit: Press [∇ TUNING] or [TUNING ∧] while “PRESET” is selected.

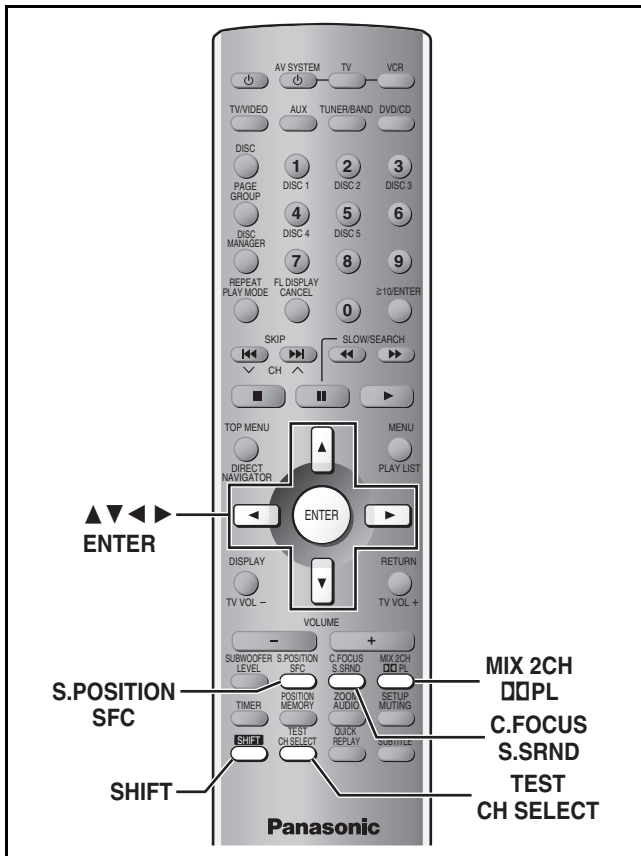

- Dolby Pro Logic, Super Surround, Center Focus, Seat Position and Subwoofer Level adjusting (➔ page 28) cannot be used if headphones are connected (“ERROR” appears on the display except Center Focus, Seat Position).
- You may experience a reduction in sound quality when these sound field systems are used with some sources. If this occurs, turn the sound field system off.

## Dolby Digital and DTS

- Dolby Digital and DTS are digital encoding systems used on DVD to carry surround sound. Both were originally developed for use in cinemas.
- This unit automatically recognizes and decodes these systems.

Software encoded with Dolby Digital can be identified with this mark.



Software encoded with DTS can be identified with this mark.



## Play a Dolby Digital or DTS source.

The Dolby Digital or DTS indicator lights.



To add power to the bass from the subwoofer ➔ page 28.

## ■ To down-mix Dolby Digital or DTS (multiple-channel) signals to 2 channels

Press [SHIFT]+[MIX 2CH] during play.  
To cancel, press [SHIFT]+[MIX 2CH] again.



### When “D.MIX” is flashing

The DVD-Audio disc you are playing contains multiple-channel signals that cannot be down-mixed (“NO DOWN-MIX” also appears).

## Dolby Pro Logic

Dolby Pro Logic is a decoding system that was developed to get a better sense of presence from sources encoded with Dolby Surround. The feeling of position has been improved by the addition of a separate center speaker channel.

Software encoded with Dolby Surround can be identified with this mark (DVD, CD, Video CD, Laser Disc, Video tape).



**1** Press [DOLBY SURROUND].



**2** Play a Dolby Surround source.

### To cancel

Press [DOLBY SURROUND] again.

### Note

Turn Dolby Pro Logic off when playing a DVD recorded with Dolby Digital or DTS. The surround effects will not be reproduced correctly if this is left on.

## Speaker level adjustments

If the level of the speakers appears to be different while listening to a source, adjust the level of the speakers to the same apparent level.

### Preparation

DOLBY DIGITAL and DTS: Turn off the other sound field systems.  
DOLBY PRO LOGIC: Press [DOLBY SURROUND].

- 1 Remove the discs (or select an empty tray).**
- 2 Press [SHIFT]+[TEST] to output a test signal.**

Lch: Front left (−16 dB to 0 dB)

Cch: Center (+6 dB to −10 dB)

Rch: Front right (−16 dB to 0 dB)

RSch: Right surround (+6 dB to −10 dB)

LSch: Left surround (+6 dB to −10 dB)

• The surround channel for Dolby Pro Logic is monaural so the indicator appears as “Sch” instead.

- 3 Press [▲] (to increase) or [▼] (to decrease).**

To stop the test signal, press [SHIFT]+[TEST] again.

### ■ To adjust speaker level during play

- 1 Press [CH SELECT] to select the speaker.**

Lch→Cch→Rch→RSch→LSch→SWch

↑  
SWch: Subwoofer (+10 dB to −10 dB)

### Dolby Pro Logic

• The surround channel is monaural so the indicator appears as “Sch” instead.

• “SWch” does not appear.

- 2 Press [▲] (to increase) or [▼] (to decrease).**

## Super Surround

Add surround effects to stereo sound.

Press [S.SRND] to select “MUSIC” or “MOVIE”.

Each time you press the button:

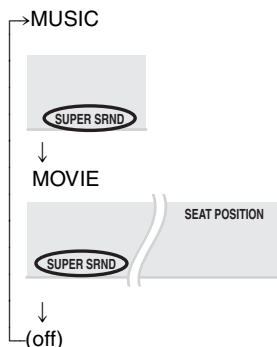

**MUSIC:** Adds surround effects to stereo sources.

**MOVIE:** Use this mode when playing movie software.

### Note

- Turn Super Surround off when playing a DVD recorded with Dolby Digital or DTS. The surround effects will not be reproduced correctly if this is left on.
- Dolby Pro Logic (➡ page 26) switches off.

### To adjust the surround speaker level

While playing a source

- ① Press [CH SELECT].
- ② Press [▲] (to increase) or [▼] (to decrease).

## Sound Field Control

Press [SFC] to select a setting.



Each time you press the button:

**HEAVY:** Adds punch to rock.

**CLEAR:** Clarifies higher sounds.

**SOFT:** For background music.

**DISCO:** Reverberates sound to make you feel like you were in a disco.

**LIVE:** Makes vocals more alive.

**HALL:** Expands sound to make you feel like you were in a hall.

**FLAT:** Canceled (no effect is added). (factory preset)

## Center Focus

You can make the sound of the center speaker seem like it is coming from within the television.

Press [SHIFT]+[C. FOCUS].

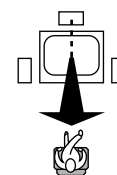

▶ CENTER FOCUS

Each time you press the button:

CENTER FOCUS 1 → CENTER FOCUS 2 → OFF

The CENTER FOCUS 2 enhances the effect and make it easier to hear dialogue even at low volume.

- This does not work when Super Surround is turned on.
- This will have less effect when Dolby Pro Logic is turned on.

### To cancel

Press [SHIFT]+[C.FOCUS] to clear “▶”.

## Seat position

Using this function makes you feel like you are sitting in the ideal seating position (in the center of the circle formed by the speakers), even if you cannot due to the layout of your room.

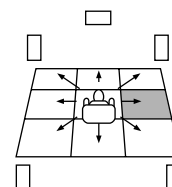

**1** Press [SHIFT]+[S.POSITION].



**2** While “▶” is flashing  
Press [▲, ▼, ◀, ▶] to select a position.



- This does not work when Super Surround “MUSIC” is turned on.

### To cancel

Press [SHIFT]+[S.POSITION] to clear “▶”.

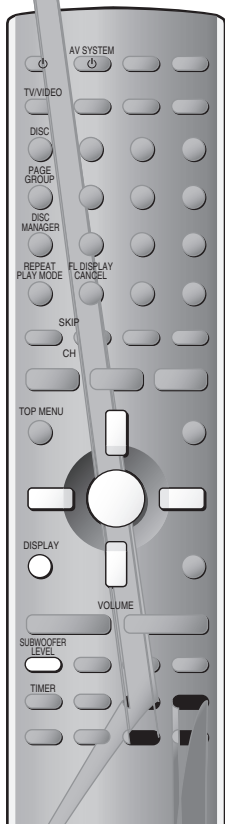

## RAM DVD-A DVD-V CD

### Discs recorded with 2-channel LPCM at 44.1 kHz or 48 kHz

This feature gives you a more natural sound by adding the higher frequency signals not recorded on the disc.

## WMA MP3

### Discs recorded at 44.1 kHz or 48 kHz

This feature reproduces the frequencies lost during recording to give you a sound closer to the original.

- 1** During play  
Press [DISPLAY] until the unit information screen is displayed  
(→ page 23).
- 2** Press [▲, ▼] to select the audio menu.
- 3** Press [◀, ▶] to select “Double Re-master”.
- 4** Press [▲, ▼].  
Each time you press the button:

## Adjusting the bass

Press [SUBWOOFER LEVEL].

Each time you press the button:  
SUB W 1 → SUB W 2 → SUB W 3 → SUB W 4 (factory preset)

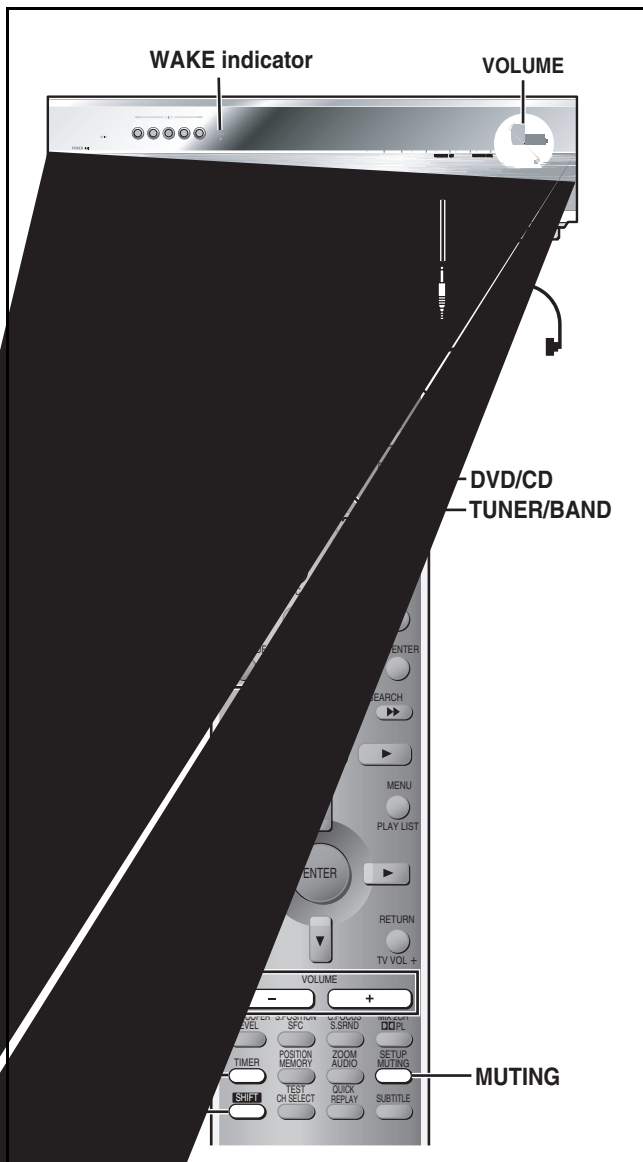

## Timer functions

The SLEEP timer can turn the unit off after a set time and the WAKE timer can turn it on. You can use only one timer at a time.

### Preparation

Select the desired source.

- **Disc**  
Press [DVD/CD] to display "DVD/CD", and insert an Audio CD, etc.
- **The radio**  
Press [TUNER/BAND] to select "FM" or "AM" and tune in the desired station.

### 1 Press [TIMER] to select the timer.

Each time you press the button:  
SLEEP → WAKE → OFF

### 2 Within 5 seconds, Press and hold [TIMER] and release when the timer you require is displayed.

The display changes as follows:

#### • SLEEP (in minutes)

30 → 60 → 90

#### • WAKE (in hours)

5H → 7H → 9H

- SLEEP starts working immediately.
- WAKE starts working when you switch the unit to standby. (The "WAKE" indicator lights up.)

### To cancel the timer

Press [TIMER] to select "OFF".

### To check the setting

Press [TIMER] once.

- If you set SLEEP, the time remaining appears.
- If you set WAKE, the setting appears.

### To change the setting

Repeat the procedure from the beginning.

## Using headphones

### 1 Reduce the volume and connect the headphones (not included).

Headphone plug type: 6.3 mm (1/4") stereo

### 2 Adjust headphone volume with [VOLUME].

Audio is automatically switched to stereo (2-channel).

### Note

Avoid listening for prolonged periods of time to prevent hearing damage.

Reduce the volume

[MUTING].

MUTING

Volume is reduced to minimum.

### To cancel

Press [MUTING] again or reduce the volume to minimum (--- dB), then raise it to the required level. Muting is also canceled when you switch the unit to standby.

## Turning off the display

The display and all indicators, except for the AC supply indicator, are turned off for better television viewing.

### Press [SHIFT]+[FL DISPLAY].

### To cancel

Press [SHIFT]+[FL DISPLAY] again.

## Connection example

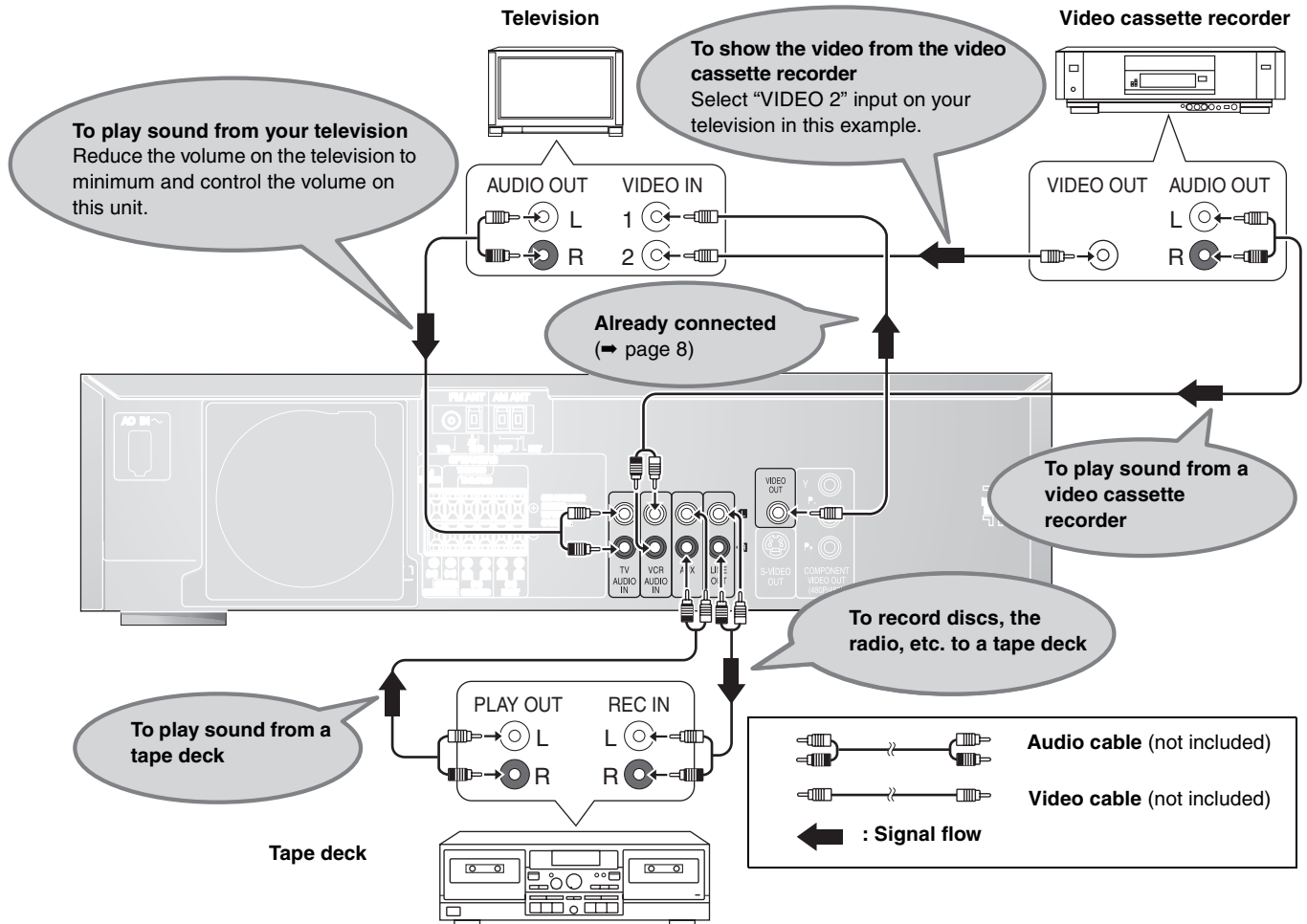

Other functions

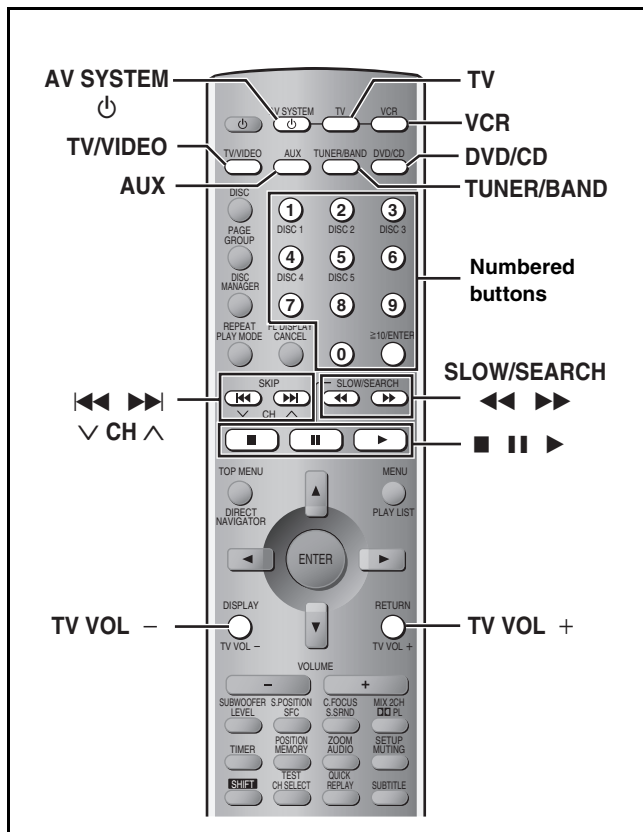

## Operating the television and the video cassette recorder

You can use the remote control to operate a Panasonic television or a video cassette recorder. (Some models cannot be operated by this remote control.)

### Television

#### Preparation

- Face the remote control at this unit and press [TV]. The button lights and "TV" appears on the unit's display. You can operate the television.
- Face the remote control at the television for the following operations.

#### Turning the television on/off

Press [AV SYSTEM].

#### Switching the television's video input mode

Press [TV/VIDEO].

#### Changing channels

Press [◀◀, v CH] or [▶▶, CH ^], or numbered buttons.

- [≥10/ENTER] is used to confirm channel selection on some televisions manufactured by other companies.

#### Adjusting the volume

Press [TV VOL+] or [TV VOL-].

## Video cassette recorder

### Preparation

- Face the remote control at this unit and press [VCR]. The button lights and “VCR” appears on the unit’s display. You can operate the video cassette recorder.
- Change the video input mode on the television (“VIDEO 2” in the example).
- Face the remote control at the video cassette recorder for the following operations.

### Turning the video cassette recorder on/off

Press [⏻ AV SYSTEM].

### Play, pause and stop

Press [▶], [⏸] or [■].

### Fast forward and rewind

Press [◀◀] or [▶▶].

## You can connect a laser disc or record player instead of a video cassette recorder.

Connect as shown on page 30 and select “VCR” as the source.

### When connecting a record player

We recommend using a record player with a built-in phono equalizer. If your player doesn’t have a built-in equalizer, connect it first to a separate equalizer and then connect that to this unit.

## Changing the remote control code

This remote control can also operate some other brands of televisions and video cassette recorders. Change the code to operate such equipment and some Panasonic products.

While aiming the remote control at the equipment,

**Press and hold [TV] or [VCR],**

**Press a numbered button to enter the first digit,**

**Press a numbered button to enter the second digit.**

The remote control outputs the on/off signal.

If the code is correct, the equipment turns on or off.

If it doesn’t, try entering another code.

- Note that this remote control cannot operate some equipment and that it may not be able to perform some operations.
- Reenter the codes after you change the batteries.

## Television code list

Panasonic:	01, 02, 26	Philco:	06, 07
Sony:	04	Philips:	06
Fisher:	14	Pioneer:	02, 10, 19
G-E:	02, 03, 07, 09	Quasar:	02
Gold Star:	07, 15	RCA:	03, 07, 09, 13, 23, 24, 25
Hitachi:	05, 07	Sanyo:	14
JVC:	12	Sharp:	08, 21
LXI:	03, 06, 07, 10, 14, 15	Sylvania:	06, 07, 15
Magnavox:	06, 07, 11, 15, 22	Symphonic:	17
Mitsubishi:	07, 15, 16, 21	Toshiba:	10, 21
NEC:	07, 15	Zenith:	18, 20

## Video cassette recorder code list

Panasonic:	01, 02, 09, 33	NEC:	19, 25, 31, 38
Sony:	05, 06, 07, 35, 36, 37	Philco:	02, 09, 12, 30
Fisher:	13, 14, 15, 18, 34	Philips:	02, 09, 12
Funai:	08, 30	Pioneer:	09
G-E:	02, 03, 11	Quasar:	01, 02, 09, 33
Gold Star:	27	RCA:	02, 03, 04, 09, 10, 11, 12, 23, 24, 26
Hitachi:	09, 10, 11	Sanyo:	14, 18, 34
JVC:	19, 25, 31, 38, 39, 40	Sharp:	16, 17
LXI:	10, 13, 14, 15, 18, 27, 30	Shintom:	32
Magnavox:	02, 09, 12	Sylvania:	02, 09, 12, 30
Mitsubishi:	21, 22, 28, 29	Symphonic:	30
		Toshiba:	23, 24
		Zenith:	20

## Operating the tape deck

### Listening to the tape deck

**Press [AUX] to select “AUX” as the source.**



### Recording to the tape deck

- 1 •Disc**  
**Press [DVD/CD] to select “DVD/CD”.**  
**•The radio**  
**Press [TUNER/BAND] to select “FM” or “AM”.**
- 2 Start recording and play.**

# Changing settings

This chart shows the settings for this unit. Change the settings to suit your preferences and to suit the unit to the environment in which it is being used. These settings are retained in memory until they are changed, even if the unit is turned off. See page 33 for details on menu operation.

• Underlined items are the factory preset.

Menus	Items	Options
<b>Disc</b> 	<b>Audio</b> Choose the preferred audio language.	<u>English</u> French Spanish Original Other **** Original: The original language of each disc will be selected. Other ****: Input a code number with the numbered buttons (⇒ page 34).
	<b>Subtitle</b> Choose the preferred subtitle language.	<u>Automatic</u> English French Spanish Other **** Automatic: If the language selected for "Audio" is not available, subtitles of that language will automatically appear if available on that disc.
	<b>Menus</b> Choose the preferred language for disc menus.	<u>English</u> French Spanish Other ****
	<b>Ratings</b> (⇒ page 33) Set a ratings level to limit DVD-Video play. • The password screen is shown if you choose levels 0 to 7 or if you choose "Ratings" when levels 0 to 7 have been selected. • Select "Level 0" to prevent play of discs that do not have ratings levels recorded on them.	<b>Setting ratings (When level 8 is selected)</b> <b>8 No Limit:</b> All DVD-Video can be played. 1 to 7: Prohibits play of DVD-Video with corresponding ratings recorded on them. 0 Lock All: Prohibits play of all DVD-Video. <b>Changing ratings (When level 0–7 is selected)</b> Unlock Player Change Level Change Password Temporary Unlock
<b>Video</b> 	<b>TV Aspect</b> (⇒ page 10) Choose the setting to suit your television and preference.	<u>4:3 Pan&amp;Scan</u> 4:3 Letterbox 16:9
	<b>TV Type</b> (⇒ page 10) Select to suit the type of television.	<u>Standard (Direct View TV)</u> CRT Projector LCD TV/Projector Projection TV Plasma TV
	<b>Still Mode</b> Specify the type of picture shown when paused.	<u>Automatic</u> Field Frame
	<b>Black Level Control</b> Change the black level of the picture if you connected a television through the COMPONENT VIDEO OUT terminals.	<u>Lighter:</u> when connected to a TV through the VIDEO OUT or S-VIDEO OUT terminal. <u>Darker:</u> when connected to a TV through the COMPONENT VIDEO OUT (Y/P <sub>B</sub> /P <sub>R</sub> ) terminals.
<b>Audio</b> 	<b>Speaker Setting</b> (⇒ page 33) Set the delay time for your center and surround speakers.	Multi-channel Center: 0/1.3/2.6/3.9/5.3 ms Surround (L/R): 0/5.3/10.6/15.9 ms
	<b>Dynamic Range Compression</b> (Dolby Digital only) Change the dynamic range for late night viewing.	<u>Off</u> On: For clear dialog when listening at low volume.
	<b>Audio during Search</b> Choose whether to have sound during search.	<u>On</u> Off • This feature doesn't work for some discs.
<b>Display</b>	<b>Menu Language</b> Choose the preferred language for these menus and the on-screen messages.	<u>English</u> Français Español
	<b>On-Screen Messages</b> Choose whether to show on-screen messages or not.	<u>On</u> Off
<b>Others</b>	<b>HighMAT</b> Play HighMAT discs as HighMAT discs, or as regular WMA/MP3/JPEG discs. (Reload the disc for the setting to be effective.)	<u>Enable:</u> Play HighMAT discs as HighMAT discs. <u>Disable:</u> Play HighMAT discs as regular WMA/MP3/JPEG discs.
	<b>Mixed Disc—Audio &amp; Stills</b> Select the type of file played on discs containing both JPEG and WMA/MP3. (Reload the disc for the setting to be effective.)	<u>Audio (MP3/WMA)</u> Stills (JPEG)
	<b>DVD-Video Mode</b> Select how to play pictures contained on some DVD-Audio. The setting returns to "Off" when you remove the disc, turn the unit off or change the source.	<u>Off:</u> DVD-Audio are played as DVD-Audio. <u>On:</u> DVD-Video contents found on DVD-Audio can be played.
	<b>QUICK SETUP</b> (⇒ page 10) Answer questions to make basic settings.	Yes (Menu language, Audio language, Subtitle language, TV type, TV aspect) <u>No</u> • G P © Đ © „Đ†δ,° #•ã•À 9Ü9B



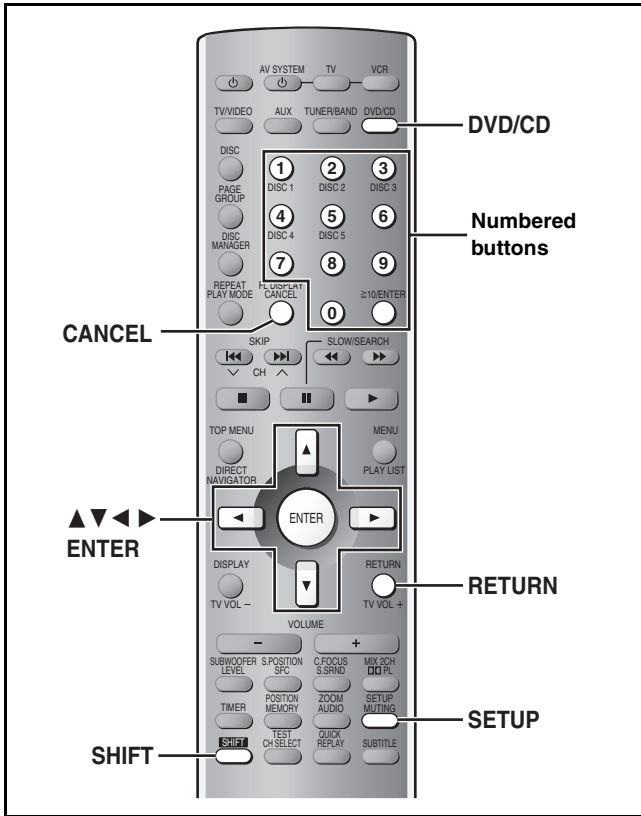

## Common procedures

See page 32 for menu and option details.

**Preparation**  
Press [DVD/CD].

**1 Press [SHIFT]+[SETUP] to show the menus.**

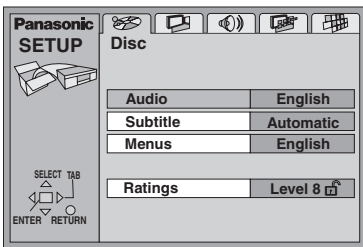

**2 Press [◀, ▶] to select the menu's tab.**

The screen changes to display the menu.

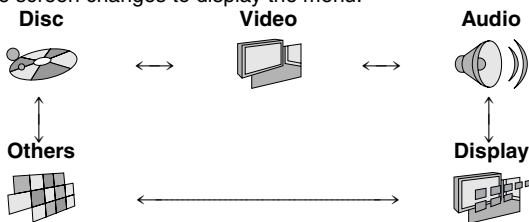

**3 Press [▲, ▼] to select the item you want to change and press [ENTER].**

**4 Press [▲, ▼, ▶, ◀] to select the option and press [ENTER].**

The screen now shows the menu again.

**To return to the previous screen**

Press [RETURN].

**When you are finished**  
Press [SHIFT]+[SETUP].

## Entering a password (Ratings)

### DVD-V

The password screen is shown when you select levels 0 to 7.

- Input a 4-digit password with the numbered buttons and press [ENTER].
  - If you enter a wrong number, press [CANCEL] to erase it before you press [ENTER].
  - The lock symbol appears closed to show the rating is locked.
  - Do not forget your password.**
- Press [ENTER] to confirm the 4 digits.

Now, when you insert a DVD-Video that exceeds the ratings limit you set, a message appears on the television. Follow the on-screen instructions.

## Changing the delay time (Speaker Setting)

### DVD-V

**(Dolby Digital, center and surround speakers only)**

For optimum listening with 5.1-channel sound, all the speakers, except for the subwoofer, should be the same distance from the seating position. If you have to place the center or surround speakers closer to the seating position, adjust the delay time to make up for the difference.

### Center delay time

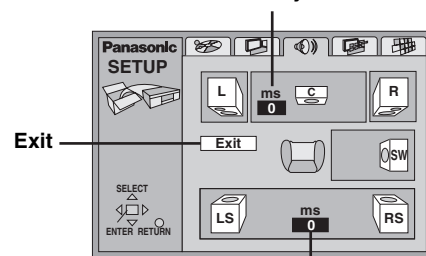

### Surround delay time

- Press [▲, ▼] to select the delay time box and press [ENTER].
- Press [▲, ▼] to adjust the delay time and press [ENTER].

### Values

If distance (a) or (b) is greater than or equal to distance (c), set to "0".  
If distance (a) or (b) is less than distance (c), set as follows.

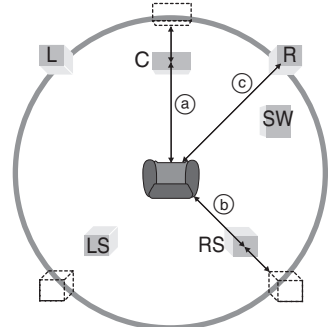

#### (a) Center speaker

Difference	Setting
Approx. 50 cm (1½ feet)	1.3 ms
Approx. 100 cm (3 feet)	2.6 ms
Approx. 150 cm (5 feet)	3.9 ms
Approx. 200 cm (6 feet)	5.3 ms

#### (b) Surround speakers

Difference	Setting
Approx. 200 cm (6 feet)	5.3 ms
Approx. 400 cm (12 feet)	10.6 ms
Approx. 600 cm (18 feet)	15.9 ms

**When you are finished**

Press [◀] to select "Exit" and press [ENTER].

Language code list

Abkhazian: 6566	Chinese: 9072	Hausa: 7265	Lithuanian: 7684	Romanian: 8279	Telugu: 8469
Afar: 6565	Corsican: 6779	Hebrew: 7387	Macedonian: 7775	Russian: 8285	Thai: 8472
Afrikaans: 6570	Croatian: 7282	Hindi: 7273	Malagasy: 7771	Samoan: 8377	Tibetan: 6679
Albanian: 8381	Czech: 6783	Hungarian: 7285	Malay: 7783	Sanskrit: 8365	Tigrinya: 8473
Ameharic: 6577	Danish: 6865	Icelandic: 7383	Malayalam: 7776	Scots Gaelic: 7168	Tonga: 8479
Arabic: 6582	Dutch: 7876	Indonesian: 7378	Maltese: 7784	Serbian: 8382	Turkish: 8482
Armenian: 7289	English: 6978	Interlingua: 7365	Maori: 7773	Serbo-Croatian: 8372	Turkmen: 8475
Assamese: 6583	Esperanto: 6979	Irish: 7165	Marathi: 7782	Shona: 8378	Twi: 8487
Aymara: 6588	Estonian: 6984	Italian: 7384	Moldavian: 7779	Sindhi: 8368	Ukrainian: 8575
Azerbaijani: 6590	Faroese: 7079	Japanese: 7465	Mongolian: 7778	Singhalese: 8373	Urdu: 8582
Bashkir: 6665	Fiji: 7074	Javanese: 7487	Nauru: 7865	Slovak: 8375	Uzbek: 8590
Basque: 6985	Finnish: 7073	Kannada: 7578	Nepali: 7869	Slovenian: 8376	Vietnamese: 8673
Bengali; Bangla: 6678	French: 7082	Kashmiri: 7583	Norwegian: 7879	Somali: 8379	Volapük: 8679
Bhutani: 6890	Frisian: 7089	Kazakh: 7575	Oriya: 7982	Spanish: 6983	Welsh: 6789
Bihari: 6672	Galician: 7176	Kirghiz: 7589	Pashto, Pushto: 8083	Sundanese: 8385	Wolof: 8779
Breton: 6682	Georgian: 7565	Korean: 7579	Persian: 7065	Swahili: 8387	Xhosa: 8872
Bulgarian: 6671	German: 6869	Kurdish: 7585	Polish: 8076	Swedish: 8386	Yiddish: 7473
Burmese: 7789	Greek: 6976	Laotian: 7679	Portuguese: 8084	Tagalog: 8476	Yoruba: 8979
Byelorussian: 6669	Greenlandic: 7576	Latin: 7665	Punjabi: 8065	Tajik: 8471	Zulu: 9085
Cambodian: 7577	Guarani: 7178	Latvian, Lettish: 7686	Quechua: 8185	Tamil: 8465	
Catalan: 6765	Gujarati: 7185	Lingala: 7678	Rhaeto-Romance: 8277	Tatar: 8484	

Optional antenna connections

Use outdoor antennas if radio reception is poor.

Note

Disconnect the antenna when the unit is not in use.  
Do not use the outdoor antenna during an electrical storm.

AM outdoor antenna  
(Using a vinyl wire)

Run a piece of vinyl wire horizontally across a window or other convenient location.

Leave the loop antenna connected.

5–12 m  
(16–39 feet)

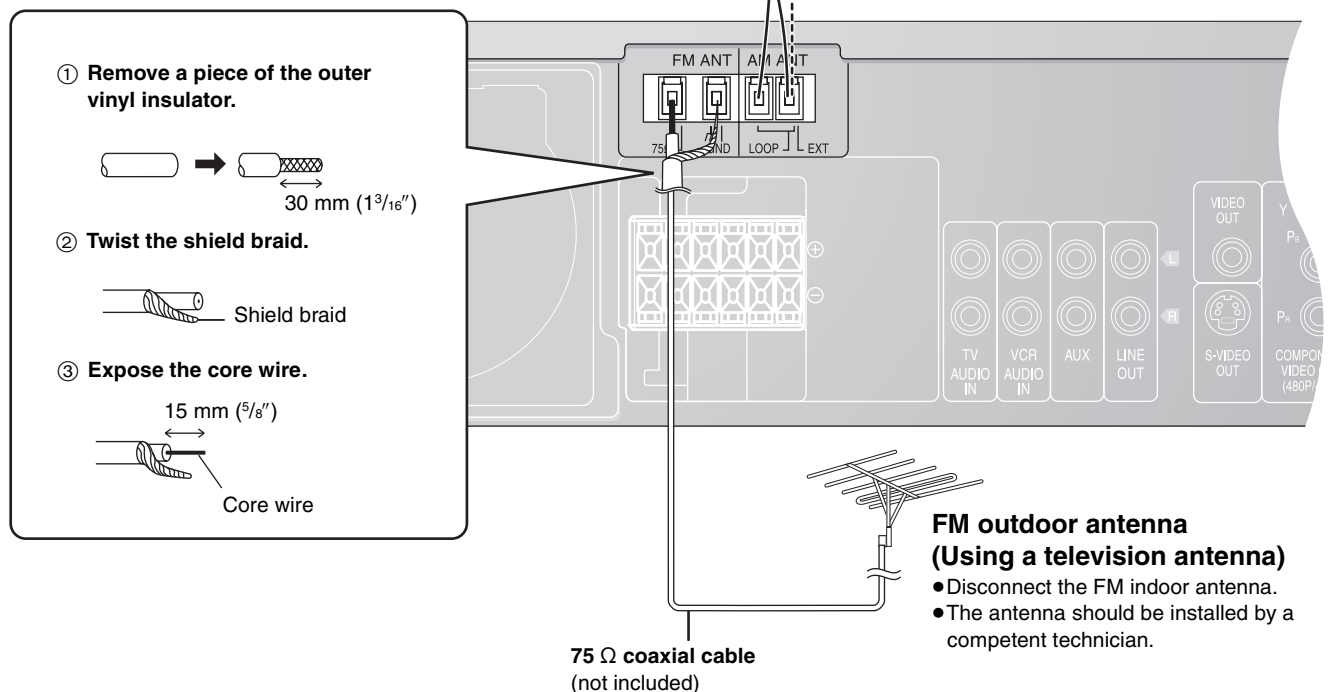

## Decoder

A decoder restores the coded audio signals on DVDs to normal. This is called decoding.

## Dolby Digital

This is a method of coding digital signals developed by Dolby Laboratories. Apart from stereo (2-channel) audio, these signals can also be multi-channel audio. A large amount of audio information can be recorded on one disc using this method.

## DTS (Digital Theater Systems)

This surround system is used in many movie theaters around the world. There is good separation between the channels, so realistic sound effects are possible.

## Dynamic range

Dynamic range is the difference between the lowest level of sound that can be heard above the noise of the equipment and the highest level of sound before distortion occurs.

## Film and video

DVD-Videos are recorded using either film or video. Usually, film is recorded at 24 frames per second, the rate movies are filmed at, while video is recorded at 30 frames per second.

## Frame still and field still

Frames are the still pictures that go together to make a moving picture. There are about 30 frames shown each second. One frame is made up of two fields. A regular television shows these fields one after the other to create frames.

A still is shown when you pause a moving picture. A frame still is made up of two alternating fields, so the picture may appear blurred, but overall quality is high.

A field still is not blurred, but it has only half the information of a frame still so picture quality is lower.

## Interlace and progressive output

NTSC, the video signal standard, has 480 interlaced (I) scan lines, whereas progressive scanning uses twice the number of scan lines. This is called 480P. The video signals output from this unit's COMPONENT VIDEO OUT terminals (Y, P<sub>B</sub>, P<sub>R</sub>) allow you to enjoy higher quality pictures than if the signals were output from the VIDEO OUT terminal or S-VIDEO OUT terminal.

## I/P/B

MPEG 2, the video compression standard adopted for use with DVD-Video, codes frames using these 3 picture types.

### I: Intra coded picture

This picture has the best quality and is the best to use when adjusting the picture.

### P: Predictive coded picture

This picture is calculated based on past I or P-pictures.

### B: Bidirectionally-predictive coded picture

This picture is calculated by comparing past and future I and P-pictures so it has the lowest volume of information.

## Linear PCM (pulse code modulation)

These are uncompressed digital signals, similar to those found on CDs.

## Playback control (PBC)

If a Video CD has playback control, you can select scenes and information with menus.

## WMA, MP3, CD text and JPEG information

- Discs must conform to ISO9660 level 1 or 2 (except for extended formats).
- This unit is compatible with multi-session but if there are a lot of sessions it takes more time for play to start. Keep the number of sessions to a minimum to avoid this.
- The order tracks appear in the menus may differ to the order shown on your computer.

### WMA

- Noise may occur when playing WMA files.
- You cannot play WMA files that are copy protected.

### MP3

- This unit is not compatible with ID3 tags.
- If you play an MP3 track that includes still picture data, it will take some time before the music itself starts playing and the elapsed time will not be displayed during this time. Even after the track starts, the correct play time will not be displayed.

### JPEG

- To view JPEG files on this unit:
  - Take them on a digital camera that meets the DCF (Design rule for Camera File System) standard. Some digital cameras have functions that are not supported by the DCF standard like automatic picture rotation which may render a picture unviewable.
  - Do not alter the files in any way or save them under a different name.
- This unit cannot display moving pictures, Motion JPEG and other such formats, still pictures other than JPEG (i.e. TIFF) or play associated sound.

### Order of play

WMA
MP3
JPEG

#### Naming folders and files

Prefix folder and file names with 3-digit numbers in the order you want to play them.

Extension

004track.wma (or .WMA)

The extension for MP3 is ".mp3" or ".MP3".

The extension for JPEG is ".JPG", ".jpg", ".JPEG" or ".jpeg".

**CD (CD text only)**

**When making your own CD text discs**

The unit plays the tracks in the order you record them so you do not have to prefix the titles with numbers.

Windows Media, and the Windows logo are trademarks, or registered trademarks of Microsoft Corporation in the United States and/or other countries.

WMA is a compression format developed by Microsoft Corporation. It achieves the same sound quality as MP3 with a file size that is smaller than that of MP3.

MPEG Layer-3 audio decoding technology licensed from Fraunhofer IIS and Thomson multimedia.

# Maintenance

## To clean this unit, wipe with a soft, damp cloth.

- Never use alcohol, paint thinner or benzine to clean this unit.
- Before using chemically treated cloth, read the instructions that came with the cloth carefully.

## Before moving the unit, ensure the disc trays are empty.

Failure to do so will risk severely damaging the discs and the unit.

## AMPLIFIER SECTION

<b>RMS Output Power: Dolby Digital Mode, 10 % Total Harmonic Distortion</b>	
1 kHz Front CH	46 W per channel (6 Ω)
1 kHz Surround CH	56 W per channel (6 Ω)
1 kHz Center CH	106 W per channel (6 Ω)
100 Hz Subwoofer CH	190 W per channel (6 Ω)
<b>Total RMS Dolby Digital Mode Power</b>	500 W
<b>FTC Output Power: Dolby Digital Mode, 1.0 % Total Harmonic Distortion</b>	
120 Hz–20 kHz Front CH	30 W per channel (6 Ω)
120 Hz–20 kHz Surround CH	38 W per channel (6 Ω)
120 Hz–20 kHz Center CH	80 W per channel (6 Ω)
45 Hz–120 Hz Subwoofer CH	144 W per channel (6 Ω)
<b>Total FTC Dolby Digital Mode Power</b>	360 W
<b>Input sensitivity/input impedance</b>	
AUX	250 mV, 10 kΩ

## FM TUNER SECTION

<b>Frequency range</b>	87.9–107.9 MHz (200 kHz-step)
	87.5–108.0 MHz (100 kHz-step)
<b>Antenna terminals</b>	75 Ω (unbalanced)
<b>Preset station</b>	12

## AM TUNER SECTION

<b>Frequency range</b>	520–1710 kHz (10 kHz-step)
<b>AM Sensitivity S/N 20 dB at 1000 kHz</b>	560 μV/m
<b>Preset station</b>	12

## DISC SECTION

### Discs played [8 cm (3") or 12 cm (5")]

- (1) DVD-RAM (DVD-VR formatted disc)
- (2) DVD-Audio
- (3) DVD-Video
- (4) DVD-R (DVD-Video formatted disc)
- (5) CD-Audio (CD-DA)
- (6) Video CD
- (7) SVCD (Conforming to IEC62107)
- (8) CD-R/CD-RW (CD-DA, Video-CD formatted disc)
- (9) MP3/WMA
  - Maximum number of tracks and groups recognizable: 999 tracks and 99 groups
  - Compatible compression rate:
    - MP3: between 32 kbps and 320 kbps
    - WMA: between 48 kbps and 192 kbps
- (10) JPEG
  - Exif Ver 2.1 JPEG Baseline files
  - Maximum number of pictures and groups recognizable: 3000 pictures and 300 groups
  - Picture resolution: between 320×240 and 6144×4096 pixels (Sub sampling is 4:2:2 or 4:2:0)
- (11) HighMAT Level 2 (Audio and Image)

### Video

<b>Signal system</b>	NTSC	
<b>Output level</b>	Composite video	1 Vp-p (75 Ω)
	S-video Y	1 Vp-p (75 Ω)
	C	0.286 Vp-p (75 Ω)
	Component video (Y: green, Pb: blue, Pr: red)	
	Y output level	1 Vp-p (75 Ω)
	P <sub>B</sub> output level	0.7 Vp-p (75 Ω)
	P <sub>R</sub> output level	0.7 Vp-p (75 Ω)

## Audio

<b>Sampling frequency</b>	
CD	44.1 kHz
MP3	44.1 kHz, 48 kHz
DVD (Linear Audio)	48 kHz, 96 kHz
DVD-Audio	192 kHz
<b>Decoding</b>	16/20/24 bit linear
<b>Number of channels</b>	5.1 ch (FL, FR, SL, SR, C, SW)
<b>Frequency response</b>	20 Hz–20 kHz (+1, –2 dB)
<b>Pick up</b>	
<b>Beam Source</b>	Semiconductor Laser
<b>Wavelength</b>	
CD/VCD	780 nm
DVD	658 nm
<b>Wow and flutter</b>	Less than possible measurement data
<b>D/A converter</b>	Delta sigma DAC

## SPEAKER SECTION

### Front and Surround speakers SB-AFC650

<b>Type</b>	1 way 1 speaker Bass-ref.
<b>Speaker unit</b>	
Full range	8 cm (3 <sup>1</sup> / <sub>8</sub> " ) cone type, 6 Ω
<b>Input power</b>	60 W (Music)
<b>Output sound pressure level</b>	79 dB/W (1.0 m)
<b>Frequency range</b>	80 Hz–22 kHz (–16 dB)
	110 Hz–20 kHz (–10 dB)
<b>Dimensions (W×H×D)</b>	88×135×117 mm (3 <sup>15</sup> / <sub>32</sub> "×5 <sup>5</sup> / <sub>16</sub> "×4 <sup>19</sup> / <sub>32</sub> " )
<b>Mass</b>	0.8 kg (1 lb.)

### Center speaker SB-PC650

<b>Type</b>	2 way 2 speaker Bass-ref.
<b>Speaker unit</b>	
Woofer	10 cm (4" ) cone type, 6 Ω
Tweeter	6 cm (2 <sup>3</sup> / <sub>8</sub> " ) cone type, 6 Ω
<b>Input power</b>	110 W (Music)
<b>Output sound pressure level</b>	83 dB/W (1.0 m)
<b>Crossover frequency</b>	4 kHz
<b>Frequency range</b>	67 Hz–22 kHz (–16 dB)
	92 Hz–20 kHz (–10 dB)
<b>Dimensions (W×H×D)</b>	207×115×148 mm (8 <sup>5</sup> / <sub>32</sub> "×4 <sup>17</sup> / <sub>32</sub> "×5 <sup>13</sup> / <sub>16</sub> " )
<b>Mass</b>	1.5 kg (3.3 lb.)

### Subwoofer SB-W650

<b>Type</b>	1 way 1 speaker Bass-ref.
<b>Speaker unit</b>	
Woofer	17 cm (6 <sup>3</sup> / <sub>4</sub> " ) cone type, 6 Ω
<b>Input power</b>	200 W (Music)
<b>Output sound pressure level</b>	80 dB/W (1.0 m)
<b>Frequency range</b>	42 Hz–1.5 kHz (–16 dB)
	46 Hz–900 Hz (–10 dB)
<b>Dimensions (W×H×D)</b>	173×372×302 mm (6 <sup>13</sup> / <sub>16</sub> "×14 <sup>2</sup> / <sub>32</sub> "×11 <sup>7</sup> / <sub>16</sub> " )
<b>Mass</b>	4.3 kg (9.5 lb.)

## GENERAL

<b>Power supply</b>	AC 120V, 60 Hz
<b>Power consumption</b>	190 W
<b>Dimensions (W×H×D)</b>	430×114×368 mm (16 <sup>15</sup> / <sub>16</sub> "×4 <sup>1</sup> / <sub>2</sub> "×14 <sup>1</sup> / <sub>2</sub> " )
<b>Mass</b>	8.2 kg (18.1 lb.)

<b>Power consumption in standby mode (approx.)</b>	0.5 W
--	-------

### Note

1. Specifications are subject to change without notice. Mass and dimensions are approximate.
2. Total harmonic distortion is measured by the digital spectrum analyzer.

# Troubleshooting guide

Before requesting service, make the below checks. If you are in doubt about some of the check points, or if the remedies indicated in the chart do not solve the problem, **contact the Panasonic Customer Call Center at 1-800-211-7262, or e-mail [consumerproducts@panasonic.com](mailto:consumerproducts@panasonic.com), or the website (<http://www.panasonic.com>).**

Power		Page
No power.	●Insert the AC power supply cord securely into the household AC outlet.	9
The unit is automatically switched to the standby mode.	●The unit was switched to standby by the sleep timer.	29
<b>Operation</b>		
No response when buttons pressed.	<ul style="list-style-type: none"> <li>●Some operations may be prohibited by the disc.</li> <li>●The unit may not be operating properly due to lightning, static electricity or some other external factor.</li> </ul> <b>Reset procedure:</b> Press [⏻] to switch the unit to the standby mode and then back to ON. Alternatively, press [⏻] to switch the unit to the standby mode, disconnect the AC power supply cord, and then reconnect it.	—
No operations can be performed with the remote control.	<ul style="list-style-type: none"> <li>●Check that the batteries are installed correctly.</li> <li>●The batteries are depleted: Replace them with new ones.</li> <li>●Point the remote control at the remote control sensor and operate.</li> </ul>	9 9 —
Cannot switch on the television with the remote control.	●Press [TV] first to operate the television.	—
Play doesn't start (or stops immediately) when you press [▶] (play).	<ul style="list-style-type: none"> <li>●Condensation has formed: Wait 1 to 2 hours for it to evaporate.</li> <li>●This unit cannot play discs other than the ones listed in these operating instructions.</li> <li>●This unit cannot play DVD-Video with a region number other than "1", "ALL" or multiple region numbers including "1".</li> <li>●The disc may be dirty and may require cleaning.</li> <li>●Ensure that the disc is installed with the label of the side to be played facing upwards.</li> <li>●Check that the DVD-RAM has something recorded on it.</li> </ul>	— 5 <b>Cover</b> 5 12 —
Cannot select alternative languages.	<ul style="list-style-type: none"> <li>●This function is dependent on software availability.</li> <li>●Try selecting from the disc's menu if one is available.</li> </ul>	— 12
No menu play.	●This function is dependent on software availability.	—
No subtitles.	<ul style="list-style-type: none"> <li>●This function is dependent on software availability.</li> <li>●Subtitles are cleared from the television. Display the subtitles.</li> </ul>	— 16
The position of the subtitles is incorrect.	●Change the position of the subtitles with "Subtitle Position" in the on-screen icon menus.	24
Soundtrack and/or subtitle language is not the one selected with the SETUP menus.	●This function is dependent on software availability.	—
Cannot change angle.	●This function is dependent on software availability. Even if a disc has a number of angles recorded, these angles may be recorded for specific scenes only.	—
The SETUP menu cannot be accessed.	<ul style="list-style-type: none"> <li>●Select "DVD/CD" as the source.</li> <li>●Cancel all group, program and random play.</li> </ul>	— 17
Cannot add markers.	●You cannot add markers while playing a play list or if the disc's play time doesn't appear on the unit's display.	—
There are already markers. <b>RAM</b>	●The unit reads and displays the markers added with a DVD video recorder. You can clear them but reappear when you switch the unit to standby, change the source, or change the disc.	—
Marker numbers I added are different when I call them up. <b>RAM</b>	●The unit numbers markers by time so they change when you add and delete them.	—
Cannot select random or program play.	●You cannot select random or program play with some DVD-Video.	—
Folders deeper than the eighth layer on a data CD are not displayed correctly.	●Folders deeper than the eighth layer are displayed as the eighth layer.	—
You have forgotten your ratings password. Reset all the SETUP settings to Factory Preset.	●While stopped and "DVD/CD" is	—

## Sound

Picture

Picture distorted.	<ul style="list-style-type: none"> <li>Some distortion is normal during SEARCH.</li> </ul>	—
No picture.	<ul style="list-style-type: none"> <li>Check the connection.</li> <li>Make sure the television is on.</li> <li>Ensure the television's video input setting (e.g., VIDEO 1) is correct.</li> </ul>	8
The picture shown on the television is not normal. (The sides of the picture are cut off, the picture is stretched horizontally, or black bands appear at the top and bottom of the screen.)	<ul style="list-style-type: none"> <li>Go to Video in the SETUP menus, and change "TV Aspect" to suit your television.</li> <li>Use the television to change the aspect to the correct one.</li> <li><b>If your television cannot change the aspect when input is progressive</b>, try changing 4:3 Aspect with the on-screen menu icons.</li> <li>Ensure that the unit is connected directly to the television, and is not connected through a video cassette recorder.</li> <li>Connect to the component video (480P) input terminals on a television compatible with this unit's copy guard system. You cannot view progressive video if your television is not compatible.</li> <li>Change the size with the variable zoom function.</li> <li>The images on PAL system DVD-Audio are compressed for display. They may also appear vertically stretched.</li> </ul>	32 — 24 — 8 18 —
There is ghosting when progressive output is on.	<ul style="list-style-type: none"> <li>Press [PROGRESSIVE OUT] so the indicator goes out. This problem is caused by the editing method or material used on DVD-Video, but should be corrected if you use interlace output.</li> </ul>	12
Picture quality is poor.	<ul style="list-style-type: none"> <li>Check the settings in the On-Screen Menu Icons' Picture Menu.</li> </ul>	24
The picture on the television disappears or stripes appear on the screen.	<ul style="list-style-type: none"> <li>Mobile telephone chargers can cause some disturbance.</li> <li>The location and orientation of the antenna are incorrect. If you are using an indoor antenna, change to an outdoor antenna.</li> <li>The television antenna wire is too close to the unit. Separate the antenna wire of the television from the unit.</li> </ul>	— 34 —
Menus not displayed correctly.	<ul style="list-style-type: none"> <li>Change the zoom ratio to "×1.00".</li> <li>With the on-screen icon menus, change "Subtitle Position" to "0" or change "4:3 Aspect" to "Normal".</li> </ul>	18 24

Listening to the radio

Noise is heard. "ST" flickers or doesn't light. Sound is distorted.	<ul style="list-style-type: none"> <li>Adjust the position of the FM or AM antenna.</li> <li>Use an outdoor antenna.</li> </ul>	— 34
A beat sound is heard.	<ul style="list-style-type: none"> <li>Turn the television off or separate it from the unit.</li> </ul>	—
A low hum is heard during AM broadcasts.	<ul style="list-style-type: none"> <li>Separate the antenna from other cables and cords.</li> </ul>	—

Unit displays

The display is dark.	<ul style="list-style-type: none"> <li>Press [SHIFT]+[FL DISPLAY] to brighten the display.</li> </ul>	29
"NO PLAY"	<ul style="list-style-type: none"> <li>You inserted a disc the unit cannot play; insert one it can.</li> <li>You inserted a blank DVD-RAM.</li> </ul>	5 —
"NO DISC"	<ul style="list-style-type: none"> <li>You haven't inserted a disc; insert one.</li> <li>You haven't inserted the disc correctly; insert it correctly.</li> </ul>	— 12
"F61"	<ul style="list-style-type: none"> <li>Check and correct the speaker cord connections.</li> <li>If this does not fix the problem, there is a power supply problem. Consult the dealer.</li> </ul>	7
"DVD U11"	<ul style="list-style-type: none"> <li>Disc is dirty. Wipe it clean.</li> </ul>	5
"ERROR"	<ul style="list-style-type: none"> <li>Incorrect operation performed. Read the instructions and try again.</li> </ul>	—
"DVD H□□" □□ stands for a number.	<ul style="list-style-type: none"> <li>Trouble may have occurred. The number following "H" depends on the status of the unit.</li> <li><b>Reset procedure:</b> Press [⏻] to switch the unit to the standby mode and then back to ON. Alternatively, press [⏻] to switch the unit to the standby mode, disconnect the AC power supply cord, and then reconnect it.</li> <li>If the service numbers fail to clear, note the service number and contact a qualified service person.</li> </ul>	— —

Television displays

No on-screen display.	<ul style="list-style-type: none"> <li>Go to Display in the SETUP menus, and select "On" for "On-Screen Messages".</li> </ul>	32
On-Screen Menu Icons not displayed or only partially displayed on the television.	<ul style="list-style-type: none"> <li>Press [▲, ▼] while the rightmost icon is highlighted to move them down.</li> </ul>	22
The disc's menu is displayed in a different language.	<ul style="list-style-type: none"> <li>Go to Disc in the SETUP menus, and select the preferred language for "Menus".</li> </ul>	32
"Cannot display group xx, picture xx."	<ul style="list-style-type: none"> <li>You are trying to display incompatible pictures.</li> </ul>	—

# Limited Warranty

Panasonic Consumer Electronics Company,  
Division of Matsushita Electric Corporation of America  
One Panasonic Way Secaucus, New Jersey 07094

Panasonic Sales Company, Division of Matsushita Electric of Puerto Rico, Inc.  
Ave. 65 de Infantería, Km. 9.5  
San Gabriel Industrial Park, Carolina, Puerto Rico 00985

## Panasonic/Technics Audio Products Limited Warranty

### Limited Warranty Coverage

If your product does not work properly because of a defect in materials or workmanship, Panasonic Consumer Electronics Company or Panasonic Sales Company (collectively referred to as "the warrantor") will, for the length of the period indicated on the chart below, which starts with the date of original purchase ("warranty period"), at its option either (a) repair your product with new or refurbished parts, or (b) replace it with a new or a refurbished product. The decision to repair or replace will be made by the warrantor.

Product or Part Name	Parts	Labor
Audio Products (except items listed below)	One (1) year	One (1) year
All Audio Racks (cabinets)	Thirty (30) days	Not Applicable
Technics Stand Alone Speakers, Subwoofer Speakers	Three (3) years	Three (3) years
USB Reader-Writer, Personal Computer Card Adapters (in exchange for defective item)	One (1) year	Not Applicable
Accessories: Headphones, Cartridges, Microphones, Adapters	Ninety (90) days	Ninety (90) days
Rechargeable Batteries (in exchange for defective item)	Ten (10) days	Not Applicable
SD Memory Cards, Rechargeable Battery Packs (in exchange for defective item)	Ninety (90) days	Not Applicable

During the "Labor" warranty period there will be no charge for labor. During the "Parts" warranty period, there will be no charge for parts. You must carry-in or mail-in your product during the warranty period. If non-rechargeable batteries are included, they are not warranted. This warranty only applies to products purchased and serviced in the United States or Puerto Rico. This warranty is extended only to the original purchaser of a new product which was not sold "as is". A purchase receipt or other proof of the original purchase date is required for warranty service.

### Carry-In or Mail-In Service

For Carry-In or Mail-In Service in the United States call 1-800-211-PANA (1-800-211-7262) or visit Panasonic web site: <http://www.panasonic.com>  
For assistance in Puerto Rico call Panasonic Sales Company (787)-750-4300 or fax (787)-768-2910.

### Limited Warranty Limits And Exclusions

This warranty ONLY COVERS failures due to defects in materials or workmanship, and DOES NOT COVER normal wear and tear or cosmetic damage. The warranty ALSO DOES NOT COVER damages which occurred in shipment, or failures which are caused by products not supplied by the warrantor, or failures which result from accidents, misuse, abuse, neglect, mishandling, misapplication, alteration, faulty installation, set-up adjustments, misadjustment of consumer controls, improper maintenance, power line surge, lightning damage, modification, or commercial use (such as in a hotel, office, restaurant, or other business), rental use of the product, service by anyone other than a Factory Servicenter or other Authorized Servicer, or damage that is attributable to acts of God.

**THERE ARE NO EXPRESS WARRANTIES EXCEPT AS LISTED UNDER "LIMITED WARRANTY COVERAGE". THE WARRANTOR IS NOT LIABLE FOR INCIDENTAL OR CONSEQUENTIAL DAMAGES RESULTING FROM THE USE OF THIS PRODUCT, OR ARISING OUT OF ANY BREACH OF THIS WARRANTY.** (As examples, this excludes damages for lost time, travel to and from the servicer, loss of media or images, data or other memory content. The items listed are not exclusive, but are for illustration only.) **ALL EXPRESS AND IMPLIED WARRANTIES, INCLUDING THE WARRANTY OF MERCHANTABILITY, ARE LIMITED TO THE PERIOD OF THE LIMITED WARRANTY.**

Some states do not allow the exclusion or limitation of incidental or consequential damages, or limitations on how long an implied warranty lasts, so the exclusions may not apply to you. This warranty gives you specific legal rights and you may also have other rights which vary from state to state. If a problem with this product develops during or after the warranty period, you may contact your dealer or Servicenter. If the problem is not handled to your satisfaction, then write to the warrantor's Consumer Affairs Department at the addresses listed for the warrantor.

**PARTS AND SERVICE WHICH ARE NOT COVERED BY THIS LIMITED WARRANTY ARE YOUR RESPONSIBILITY.**

## Customer Services Directory

*For Product Information, Operating Assistance, Literature Request, Dealer Locations, and all Customer Service inquiries please contact:*  
**1-800-211-PANA (7262), Monday–Friday 9 am–9 pm; Saturday–Sunday 9 am–7 pm, EST.**  
*or send e-mail:*  
**[consumerproducts@panasonic.com](mailto:consumerproducts@panasonic.com)**  
*For hearing or speech impaired TTY users, TTY: 1-877-833-8855*

**Web Site: <http://www.panasonic.com>**  
*You can purchase parts, accessories or locate your nearest servicenter by visiting our Web Site.*

### Accessory Purchases:

1-800-332-5368 (Customer Orders Only)  
For hearing or speech impaired TTY users, TTY: 1-866-605-1277  
Panasonic Services Company 20421 84th Avenue South, Kent, WA 98032  
(6 am to 5 pm Monday–Friday; 6 am to 10:30 am Saturday; PST)  
(Visa, MasterCard, Discover Card, American Express, Check)

### Service in Puerto Rico

**Matsushita Electric of Puerto Rico, Inc. Panasonic Sales Company/Factory Servicenter:**  
**Ave. 65 de Infantería, Km. 9.5, San Gabriel Industrial Park, Carolina, Puerto Rico 00985**  
**Phone (787) 750-4300 Fax (787) 768-2910**

## Listening caution



Selecting fine audio equipment such as the unit you've just purchased is only the start of your musical enjoyment. Now it's time to consider how you can maximize the fun and excitement your equipment offers. This manufacturer and the Electronic Industries Association's Consumer Electronics Group want you to get the most out of your equipment by playing it at a safe level. One that lets the sound come through loud and clear without annoying blaring or distortion—and, most importantly, without affecting your sensitive hearing.

We recommend that you avoid prolonged exposure to excessive noise.

Sound can be deceiving. Over time your hearing "comfort level" adapts to higher volumes of sound. So what sounds "normal" can actually be loud and harmful to your hearing.

Guard against this by setting your equipment at a safe level BEFORE your hearing adapts.

To establish a safe level:

- Start your volume control at a low setting.
- Slowly increase the sound until you can hear it comfortably and clearly, and without distortion.

Once you have established a comfortable sound level:

- Set the dial and leave it there.

Taking a minute to do this now will help to prevent hearing damage or loss in the future. After all, we want you listening for a lifetime.

## Product Service

- 1. Damage requiring service**—The unit should be serviced by qualified service personnel if:
  - (a) The AC power supply cord or AC adaptor has been damaged; or
  - (b) Objects or liquids have gotten into the unit; or
  - (c) The unit has been exposed to rain; or
  - (d) The unit does not operate normally or exhibits a marked change in performance; or
  - (e) The unit has been dropped or the cabinet damaged.
- 2. Servicing**—Do not attempt to service the unit beyond that described in these operating instructions. Refer all other servicing to authorized servicing personnel.
- 3. Replacement parts**—When parts need replacing ensure the servicer uses parts specified by the manufacturer or parts that have the same characteristics as the original parts. Unauthorized substitutes may result in fire, electric shock, or other hazards.
- 4. Safety check**—After repairs or service, ask the servicer to perform safety checks to confirm that the unit is in proper working condition.

The servicer will require all components to service your system.

Therefore, should service ever be necessary, be sure to bring the entire system.

### Product information

For product information or assistance with product operation:

Contact the Panasonic Customer Call Center at 1-800-211-7262, or e-mail [consumerproducts@panasonic.com](mailto:consumerproducts@panasonic.com), or the website (<http://www.panasonic.com>).

Manufactured under license from Dolby Laboratories. "Dolby", "Pro Logic" and the double-D symbol are trademarks of Dolby Laboratories.

Manufactured under license from Digital Theater Systems, Inc. US Pat. No. 5,451,942, 5,956,674, 5,974,380, 5,978,762 and other world-wide patents issued and pending. "DTS" and "DTS Digital Surround" are registered trademarks of Digital Theater Systems, Inc. Copyright 1996, 2000 Digital Theater Systems, Inc. All rights reserved.

Apparatus Claims of U.S. Patent Nos. 4,631,603, 4,577,216, and 4,819,098, licensed for limited viewing uses only.

This product incorporates copyright protection technology that is protected by method claims of certain U.S. patents and other intellectual property rights owned by Macrovision Corporation and other rights owners. Use of this copyright protection technology must be authorized by Macrovision Corporation, and is intended for home and other limited viewing uses only unless otherwise authorized by Macrovision Corporation. Reverse engineering or disassembly is prohibited.

**Panasonic Consumer Electronics Company,  
Division of Matsushita Electric Corporation  
of America**

One Panasonic Way Secaucus,  
New Jersey 07094  
<http://www.panasonic.com>

**Panasonic Sales Company,  
Division of Matsushita Electric of  
Puerto Rico, Inc. ("PSC")**

Ave. 65 de Infantería, Km. 9.5  
San Gabriel Industrial Park, Carolina,  
Puerto Rico 00985

En