

Projector

CP-X505/CP-X605

User's Manual – Operating Guide

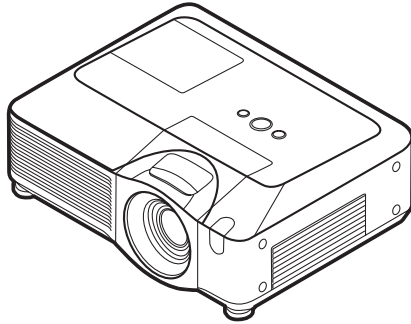

Thank you for purchasing this projector.

⚠ WARNING ▶ Before using this product, please read the "User's Manual - Safety Guide" and related manuals to ensure the proper use of this product. After reading them, store them in a safe place for future reference.

About this manual

Various symbols are used in this manual. The meanings of these symbols are described below.

⚠ WARNING This symbol indicates information that, if ignored, could possibly result in personal injury or even death due to incorrect handling.

⚠ CAUTION This symbol indicates information that, if ignored, could possibly result in personal injury or physical damage due to incorrect handling.

 Please refer to the pages written following this symbol.

NOTE • The information in this manual is subject to change without notice.

- The manufacturer assumes no responsibility for any errors that may appear in this manual.
- The reproduction, transfer or copy of all or any part of this document is not permitted without express written consent.

Trademark acknowledgment

- Mac is registered trademarks of Apple Computer, Inc.
- VESA and SVGA are trademarks of the Video Electronics Standard Association.
- Windows is a registered trademark of Microsoft Corporation.
-  is a trademark of SRS Labs, Inc.
- WOW technology is incorporated under license from SRS Labs, Inc.

All other trademarks are the properties of their respective owners.

Projector features

This projector is used to project various picture signals onto a screen. This projector requires only a minimal amount of space for installation and can produce a large projected image from even a short distance.

Preparations

Contents of package

Please see the “Contents of package” in the “User’s Manual (concise)” which is a book. Your projector should come with the items shown there. Contact immediately your dealer if anything is missing.

NOTE • Keep the original packing materials for future reshipment. Be sure to use the original packing materials when moving the projector. Use special caution for the lens.

Fastening the lens cover

To avoid losing the lens cover, please fasten the lens cover to the projector using the included strap.

1. Fix the strap to the strap hole of the lens cover.
2. Put one side of the strap into the groove on the rivet.
3. Push the rivet into the rivet hole.

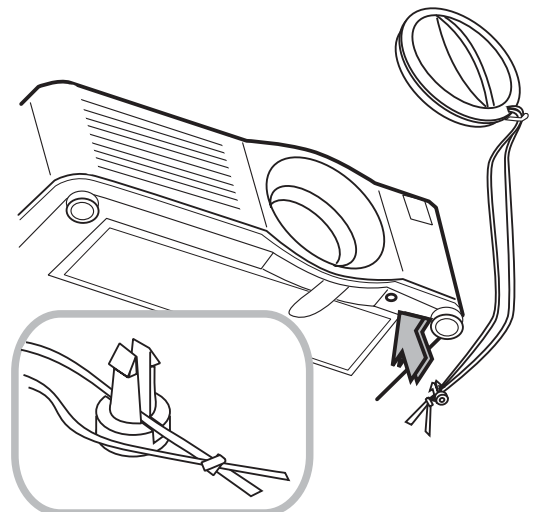

Part names

Projector

- (1) Speakers (x 4) (📖37).
- (2) Focus ring (📖19)
- (3) Zoom ring (📖19)
- (4) Lamp cover (📖56)
The lamp unit is inside.
- (5) Lens shift cover (📖19)
- (6) Horizontal lens shift dial (📖19)
- (7) Vertical lens shift dial (📖19)
- (8) Front cover
- (9) Lens (📖61)
- (10) Lens cover (📖3)
- (11) Remote sensors (x 3) (📖14)
- (12) Elevator feet (x 2) (📖9)
- (13) Elevator knobs (x 2) (📖14)
- (14) Filter cover (📖58)
The air filter and intake vents are inside.
- (15) Exhaust vents
- (16) Intake vents
- (17) Rivet hole (📖14)
- (18) Handle
- (19) Battery cover
- (20) Control panel
- (21) Rear panel

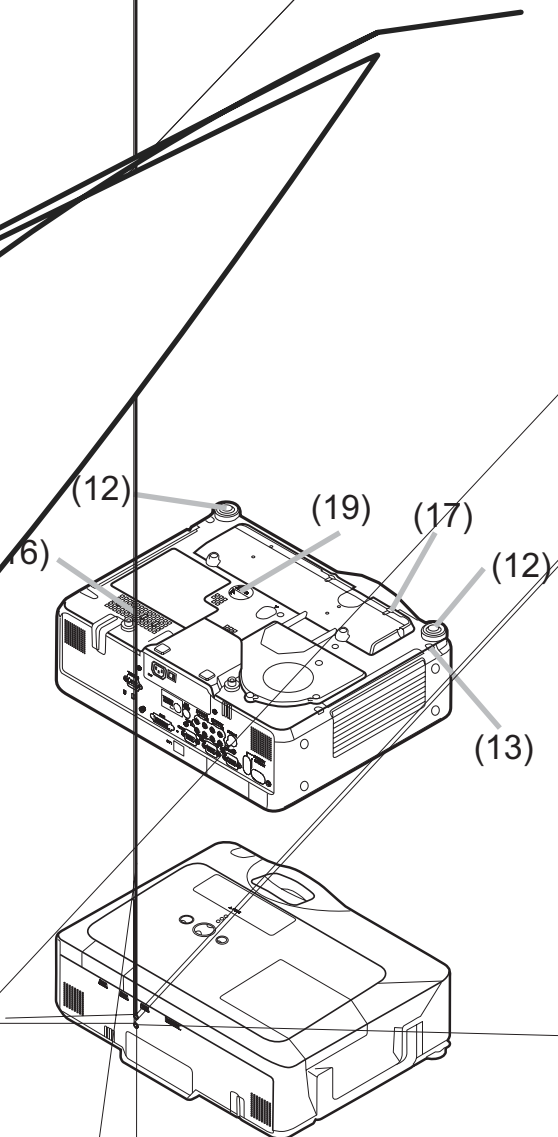

⚠️ **WARNING ►HOT!** : Do not touch around the lamp cover and the exhaust vents during use or just after use, since it is too hot.

► Do not look into the lens or vents while the lamp is on, since the strong light is not good for your eyes.

► Do not grab the front cover to hold the projector up, since the projector may drop down.

► Do not handle the elevator knobs without holding the projector, since the projector may drop down.

⚠️ **CAUTION ►** Maintain normal ventilation to prevent the projector from heating up. Do not cover, block or plug up the vents. Do not place anything that can stick or be sucked to the vents, around the intake vents. Clean the air filter periodically.

Control panel

- (1) STANDBY/ON button (📖16)
- (2) MENU button (📖23)
It consists of four cursor buttons.
- (3) INPUT button (📖17)
- (4) POWER indicator (📖16)
- (5) TEMP indicator (📖63)
- (6) LAMP indicator (📖63)

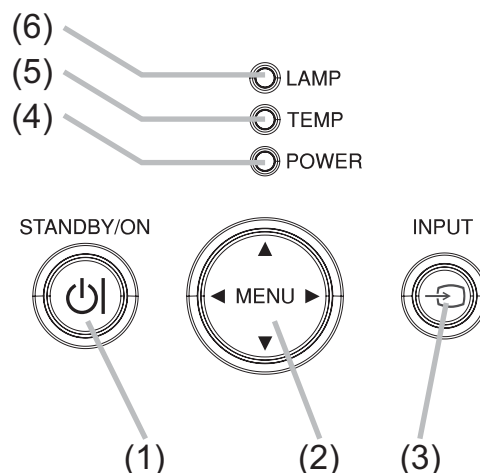

Rear panel

- (1) Shutdown switch (📖65)
- (2) Security slot (📖9)
- (3) Security bar (📖9)
- (4) AC inlet (📖12)
- (5) Power switch (📖16)
- (6) RGB1 port (📖10)
- (7) RGB2 port (📖10)
- (8) CONTROL port (📖10)
- (9) M1-D port (📖10)
- (10) VIDEO port (📖10)
- (11) S-VIDEO port (📖10)
- (12) COMPONENT (Y, Cb/Pb, Cr/Pr) ports (📖10)
- (13) AUDIO IN1 port (📖10)
- (14) AUDIO IN2 port (📖10)
- (15) AUDIO IN3 (R/L) ports (📖10)
- (16) AUDIO IN4 (R/L) ports (📖10)
- (17) RGB OUT port (📖10)
- (18) AUDIO OUT port (📖10)
- (19) REMOTE CONTROL port (📖10)
- (20) LAN port (📖10)

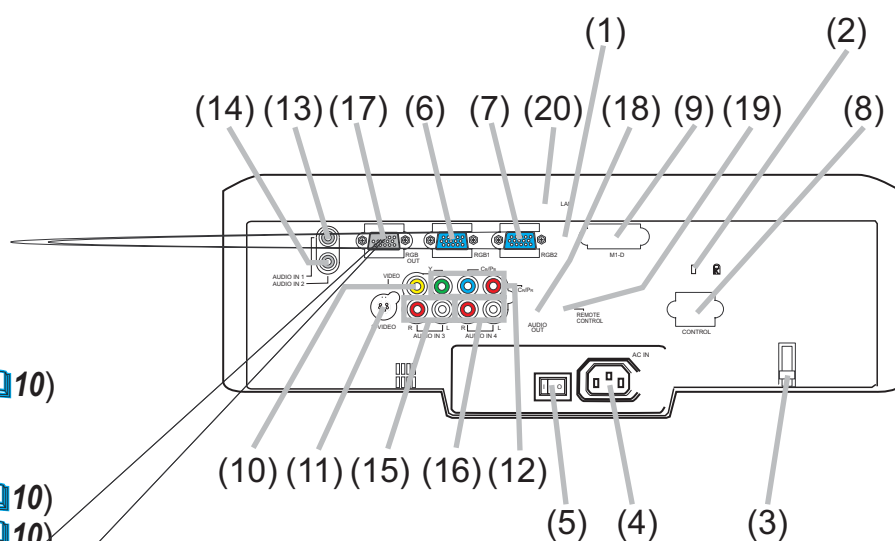

⚠ CAUTION ▶ Do not use the security bar and the security slot to prevent the projector from falling down, since it is not designed for it.

▶ Use the shutdown switch only when the projector is not turned off by normal procedure, since pushing this switch stops operation of the projector without cooling it down.

Remote control

- (1) Laser pointer (📖13)
It is a beam outlet.
- (2) LASER INDICATOR (📖13)
- (3) LASER button (📖13)
- (4) STANDBY/ON button (📖16)
- (5) VOLUME button (📖17)
- (6) MUTE button (📖17)
- (7) VIDEO button (📖18)
- (8) RGB button (📖17)
- (9) SEARCH button (📖18)
- (10) AUTO button (📖19)
- (11) ASPECT button (📖18)
- (12) POSITION button (📖20)
- (13) KEYSTONE button (📖20)
- (14) MAGNIFY - ON button (📖21)
- (15) MAGNIFY - OFF button (📖21)
- (16) FREEZE button (📖21)
- (17) BLANK button (📖22)
- (18) MY BUTTON - 1 button (📖44)
- (19) MY BUTTON - 2 button (📖44)
- (20) MENU button (📖23)
- (21) Lever switch (📖23) : acting 3 functions as below.
Cursor button ▲ : to slide toward the side marked ▲.
Cursor button ▼ : to slide toward the side marked ▼.
ENTER button : to push down the center point.
- (22) Cursor button ◀ (📖23)
- (23) Cursor button ▶ (📖23)
- (24) RESET button (📖23)
- (25) ESC button (📖23)
- (26) Mouse left button (📖15)
- (27) Mouse right button (📖15)
- (28) PAGE UP button (📖15)
- (29) PAGE DOWN button (📖15)
- (30) Wired remote control port (📖15)
- (31) Battery cover (📖13)
- (32) Battery holder (📖13)
- (33) Frequency switch (📖14)

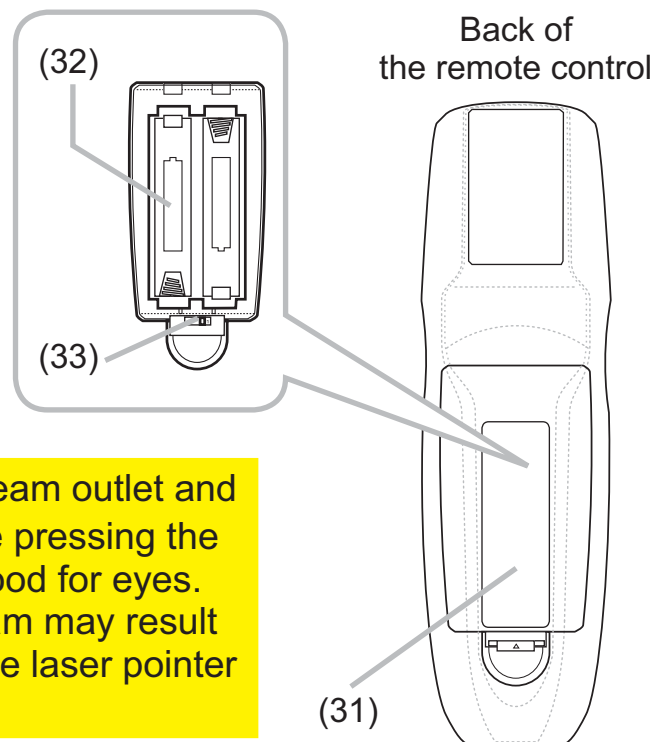
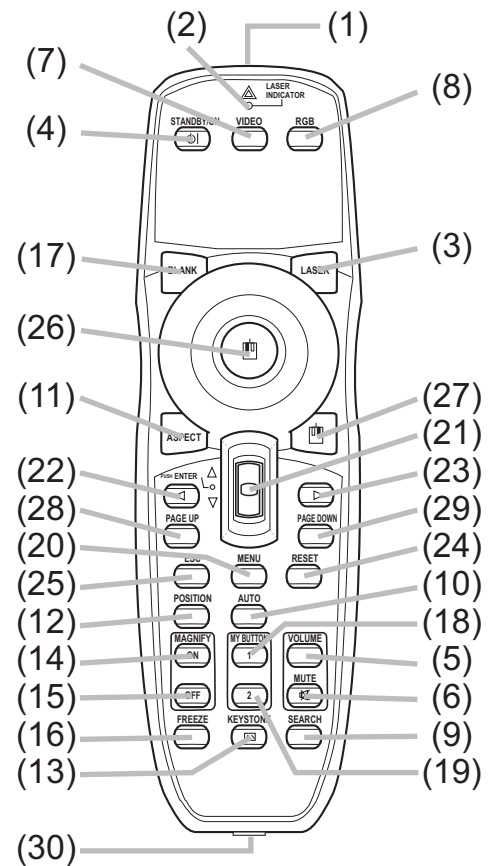

⚠️WARNING ▶ Do not look into the beam outlet and point the beam at people and pets while pressing the LASER button, since the beam is not good for eyes.
⚠️CAUTION ▶ Note that the laser beam may result in hazardous radiation exposure. Use the laser pointer only for pointing on the screen.

Setting up

Install the projector according to the environment and manner the projector will be used in.

⚠WARNING ► Place the projector in a stable horizontal position. If the projector falls or is knocked over it could cause injury and/or damage to the projector. Using a damaged projector could then result in fire and/or electric shock.

- Do not place the projector on an unstable, slanted or vibrational surface such as a wobbly or inclined stand.
- Do not place the projector on its side, front or rear position.
- Consult with your dealer before a special installation such as suspending from a ceiling.

► Place the projector in a cool place, and ensure that there is sufficient ventilation. The high temperature of the projector could cause fire, burns and/or malfunction of the projector.

- Do not stop-up, block or otherwise cover the projector's vents.
- Keep a space of 30 cm or more between the sides of the projector and other objects such as walls.
- Do not place the projector on metallic thing or anything weak in heat.
- Do not place the projector on carpet, cushions or bedding.
- Do not place the projector in direct sunlight or near hot objects such as heaters.
- Do not place anything near the projector lens or vents, or on top of the projector.
- Do not place anything that may be sucked into or stick to the vents on the bottom of the projector. This projector has some intake vents also on the bottom.

► Do not place the projector anyplace where it may get wet. Getting the projector wet or inserting liquid into the projector could cause fire, electric shock and/or malfunction of the projector.

- Do not place the projector in a bathroom or the outdoors.
- Do not place anything containing liquid near the projector.

⚠CAUTION ► Avoid placing the projector in smoky, humid or dusty place. Placing the projector in such places could cause fire, electric shock and/or malfunction of the projector.

- Do not place the projector near humidifiers, smoking spaces or a kitchen.

► Position the projector to prevent light from directly hitting the projector's remote sensor.

Arrangement

Refer to the illustrations and tables below to determine screen size and projection distance.

The values shown in the table are calculated for a full size screen: 1024×768

(a) Screen size (diagonal)

(b) Projection distance ($\pm 10\%$)

(c) Screen height ($\pm 10\%$), when the vertical lens shift is set full upward (📖19)

On a horizontal surface

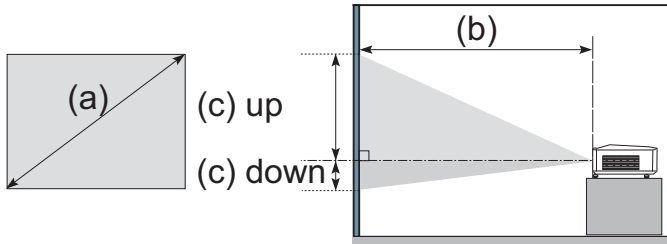

Suspended from the ceiling

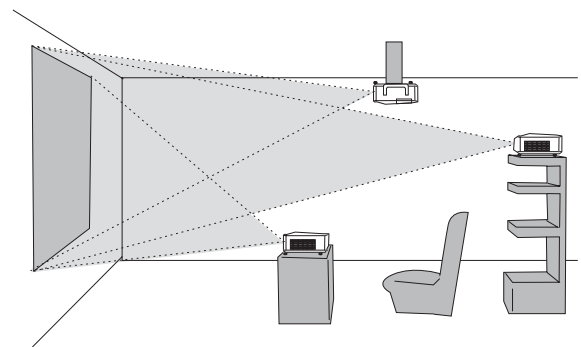
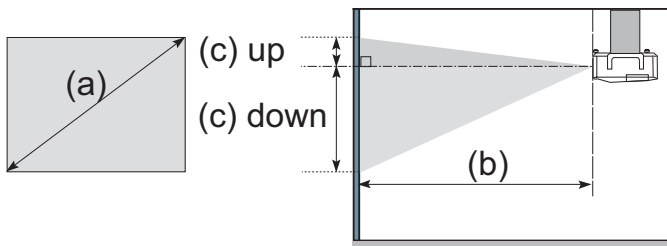

- Keep a space of 30 cm or more between the sides of the projector and other objects such as walls.
- Consult with your dealer before a special installation such as suspending from a ceiling.

| (a) Screen size [inch (m)] | 4 : 3 screen | | | | 16 : 9 screen | | | |
|-------------------------------|---------------------------------------|------------|----------------------------------|-----------|---------------------------------------|------------|----------------------------------|-----------|
| | (b) Projection distance [m (inch)] | | (c) Screen height [cm (inch)] | | (b) Projection distance [m (inch)] | | (c) Screen height [cm (inch)] | |
| | min. | max. | down | up | min. | max. | down | up |
| 30 (0.8) | 0.9 (35) | 1.1 (42) | 5 (2) | 41 (16) | 1.0 (38) | 1.2 (46) | -1 (0) | 39 (15) |
| 40 (1.0) | 1.2 (47) | 1.4 (57) | 6 (2) | 55 (22) | 1.3 (51) | 1.6 (62) | -2 (-1) | 51 (20) |
| 60 (1.5) | 1.8 (71) | 2.2 (86) | 9 (4) | 82 (32) | 2.0 (78) | 2.4 (94) | -2 (-1) | 77 (30) |
| 70 (1.8) | 2.1 (83) | 2.6 (100) | 11 (4) | 96 (38) | 2.3 (91) | 2.8 (110) | -3 (-1) | 90 (35) |
| 80 (2.0) | 2.4 (96) | 2.9 (115) | 12 (5) | 110 (43) | 2.6 (104) | 3.2 (126) | -3 (-1) | 103 (41) |
| 90 (2.3) | 2.7 (108) | 3.3 (130) | 14 (5) | 123 (49) | 3.0 (117) | 3.6 (141) | -4 (-1) | 116 (46) |
| 100 (2.5) | 3.0 (120) | 3.7 (144) | 15 (6) | 137 (54) | 3.3 (131) | 4.0 (157) | -4 (-2) | 129 (51) |
| 120 (3.0) | 3.7 (144) | 4.4 (174) | 18 (7) | 165 (65) | 4.0 (157) | 4.8 (189) | -5 (-2) | 154 (61) |
| 150 (3.8) | 4.6 (181) | 5.5 (217) | 23 (9) | 206 (81) | 5.0 (197) | 6.0 (237) | -6 (-2) | 193 (76) |
| 200 (5.1) | 6.1 (241) | 7.4 (291) | 30 (12) | 274 (108) | 6.7 (263) | 8.0 (317) | -8 (-3) | 257 (101) |
| 250 (6.4) | 7.7 (302) | 9.2 (364) | 38 (15) | 343 (135) | 8.4 (329) | 10.1 (396) | -10 (-4) | 322 (127) |
| 300 (7.6) | 9.2 (363) | 11.1 (437) | 46 (18) | 411 (162) | 10.0 (395) | 12.1 (476) | -12 (-5) | 386 (152) |
| 350 (8.9) | 10.8 (424) | 13.0 (510) | 53 (21) | 480 (189) | 11.7 (462) | 14.1 (556) | -15 (-6) | 450 (177) |

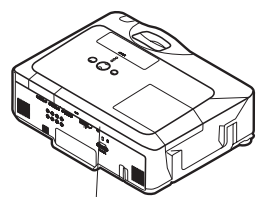

Connecting your devices

Be sure to read the manuals for devices before connecting them to the projector. Make sure that all the devices are suitable to be connected with this product, and prepare the cables required to connect.

Please refer to the following illustrations to connect them.

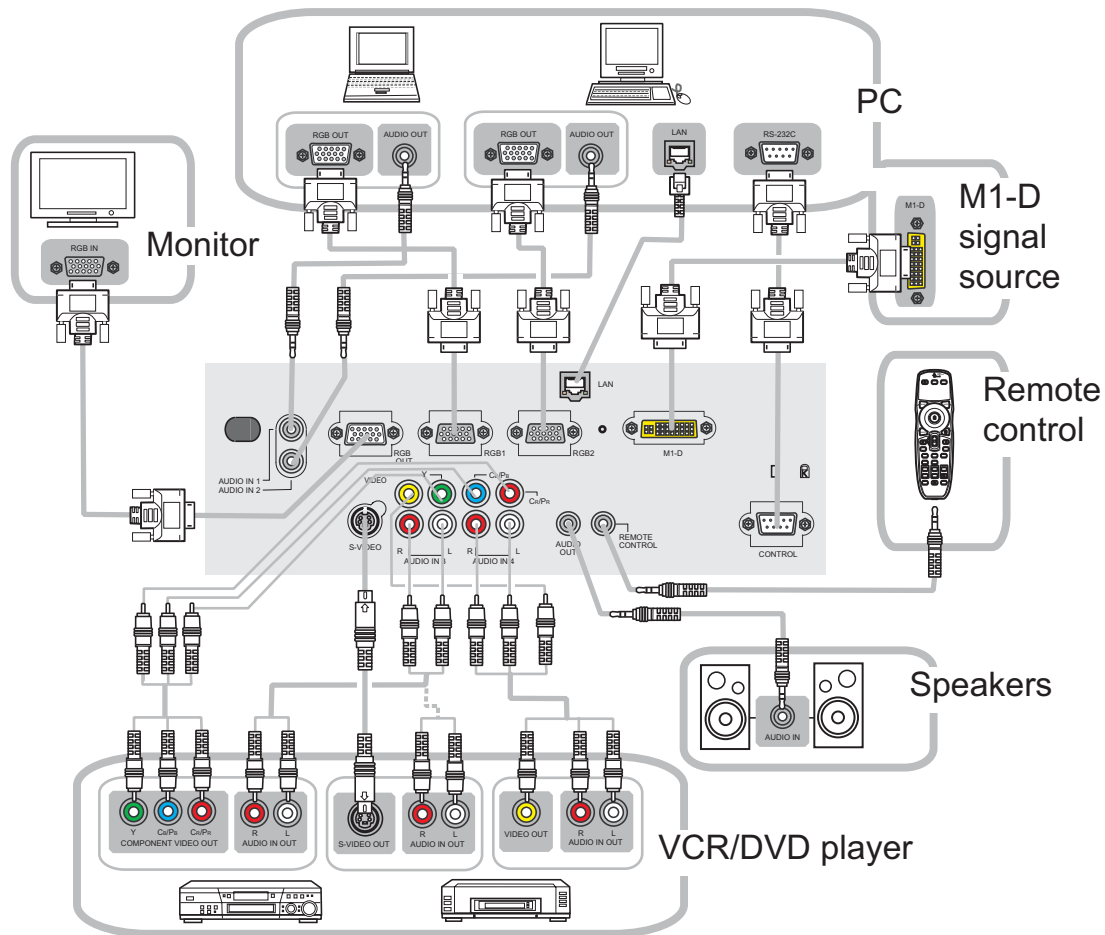

- ⚠ **WARNING** ▶ Do not disassemble or modify the projector.
- ▶ Be careful not to damage the cables, and do not use damaged cables.
- ⚠ **CAUTION** ▶ Turn off all devices and unplug their power cords prior to connecting them to projector. Connecting a live device to the projector may generate extremely loud noises or other abnormalities that may result in malfunction or damage to the device and the projector.
- ▶ Use appropriate accessory or otherwise designed cables. Ask your dealer about non-accessory cables which may have to be of a specific length or equipped with a core. For cables with a core only at one end, connect the end with the core to the projector.
- ▶ Make sure that devices are connected to the correct ports. An incorrect connection may result in malfunction or damage to the device and the projector.

NOTE • Be sure to read the manuals for devices before connecting them to the projector, and make sure that all the devices are suitable to be connected with this product. Before connecting to a PC, check the signal level, the signal timing, and the resolution.

- Do not connect LAN port to any network that might have the excessive voltage.
- Some signal may need an adapter to input this projector.
- Some PCs have multiple screen display modes that may include some signals which are not supported by this projector.
- Although the projector can display signals with resolution up to UXGA (1600X1200), the signal will be converted to the projector's panel resolution before being displayed. The best display performance will be achieved if the resolutions of the input signal and the projector panel are identical.
- While connecting, make sure that the shape of the cable's connector fits the port to connect with. And be sure to tighten the screws on connectors with screws.
- When connecting a laptop PC to the projector, be sure to activate the PC's external RGB output. (Set the laptop PC to CRT display or to simultaneous LCD and CRT display.) For details on how this is done, please refer to the instruction manual of the

Connecting power supply

1. Connect the connector of the power cord to the AC inlet of the projector.
2. Firmly plug the power cord's plug into the outlet.

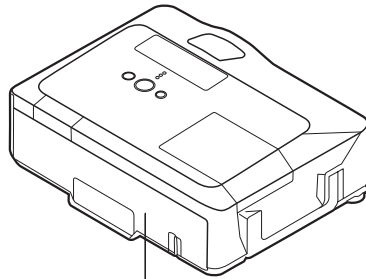

⚠ WARNING ► Please use extra caution when connecting the power cord, as incorrect or faulty connections may result in fire and/or electrical shock.

- Only use the power cord that came with the projector. If it is damaged, contact your dealer to newly get correct one.
- Only plug the power cord into an outlet rated for use with the power cord's specified voltage range.
- Never modify the power cord. Never attempt to defeat the ground connection of the three-pronged plug.

Remote control

Laser pointer

This remote control has a laser pointer in place of a finger or rod. The laser beam works and the LASER INDICATOR lights while the LASER button is pressed.

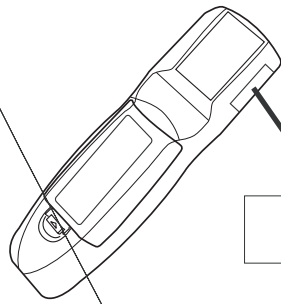
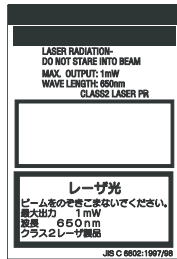

LASER INDICATOR

LASER button

⚠ WARNING ▶ The laser pointer of the remote control is used in place of a finger or rod. Never look directly into the laser beam outlet or point the laser beam at other people. The laser beam can cause vision problems.

⚠ CAUTION ▶ Use of controls or adjustments or performance of procedures other than those specified herein may result in hazardous radiation exposure.

Putting battery

Please load the battery. If the remote control malfunctions, replace the battery. After the use period, remove the battery.

1. Slide battery cover of the remote control.
2. Align the plus and minus terminals of the battery and plug it in.
3. Close the battery cover.



⚠ WARNING ▶ Always handle the batteries with care and use them only as directed. Improper use may result in battery explosion, cracking or leakage, which could result in fire, injury and/or pollution of the surrounding environment.

- Be sure to use only the batteries specified. Do not use batteries of different types at the same time. Do not mix a new battery with used one.
- Make sure the plus and minus terminals are correctly aligned when loading a battery.
- Keep a battery away from children and pets.
- Do not recharge, short circuit, solder or disassemble a battery.
- Do not allow a battery in a fire or water. Keep batteries in a dark, cool and dry place.
- If you observe a leakage of a battery, wipe out the flow and then replace a battery. If the flow adheres your body or clothes, rinse well with water immediately.

Changing the frequency of remote control signal

The accessory remote control has the choice of the mode 1 or the mode 2, in the frequency of its signal. If the remote control does not function properly, attempt to change the signal frequency. Please remember that the "REMOTE FREQ." in SERVICE item of OPTION menu (

Using as a wired remote control

The accessory remote control works as a wired remote control, when the wired control port at the bottom of the remote control connects with the REMOTE CONTROL port on the back of the projector via an audio cable with 3.5 diameter stereo mini plugs.

When the remote control signal is hard to reach surely to the projector in the environment, this function is effective.

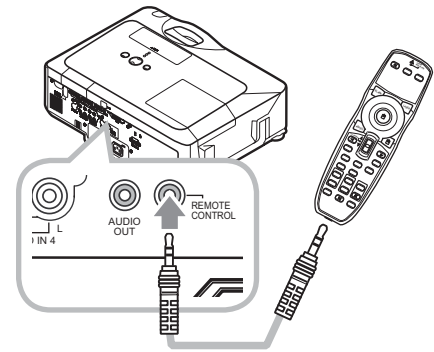

NOTE • To connect the remote control with the projector, use an audio cable with 3.5 diameter stereo mini plugs.

Using as a simple PC mouse & keyboard

The accessory remote control works as a simple mouse and keyboard of the PC, when an M1-D/USB cable connects this projector's M1-D port with the PC's DVI-D and USB (A type) ports.

(1) Mouse left button

Pushing the button into the center point works instead of clicking the mouse's left button.

Tilting this button to one of eight directions moves the PC's move pointer on the screen in the direction.

(2) Mouse right button

Pressing the button works instead of clicking the mouse's right button.

(3) Lever switch

Sliding toward the side marked ▲ works instead of the [↑] key on the keyboard. Sliding toward the side marked ▼ works instead of the [↓] key on the keyboard.

(4) Left arrow button

This button works instead of the [←] key on the keyboard.

(5) Right arrow button

This button works instead of the [→] key on the keyboard.

(6) PAGE UP button

This button works instead of the PAGE UP key on the key board.

(7) PAGE DOWN button

This button works instead of the PAGE DOWN key on the key board.

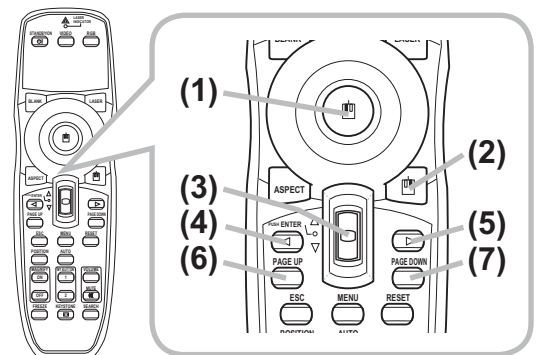
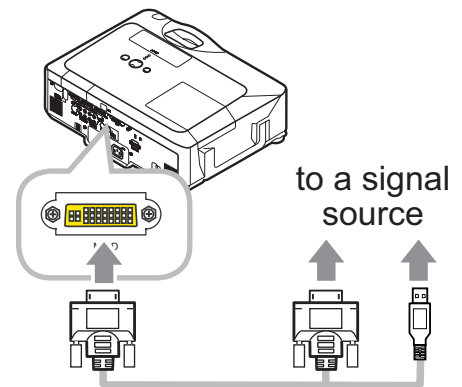

NOTE • When the simple mouse & keyboard function of this product does not work correctly, please check the following.

- When an M1-D/USB cable connects this projector with a PC having a built-in pointing device (e.g. track ball) like a notebook PC, open BIOS setup menu, then select the external mouse and disable the built-in pointing device, because the built-in pointing device may have priority to this function.
- Windows 95 OSR 2.1 or higher is required for this function. And also this function may not work depending on the PC's configurations and mouse drivers.
- Operating simultaneously two or more keys is void except for mouse drag and drop operation.
- This function is activated only when the projector is working properly.

Power on/off

Turning on the power

1. Make sure that the power cord is firmly and correctly connected to the projector and the outlet.
2. Remove the lens cover, and set the power switch to the ON position.
The power indicator will light up in steady orange (📖63). Then wait several seconds because the buttons may not function for these several seconds.

(1) When **AUTO ON in OPTION menu is set to TURN ON** (📖42) :
The lamp will only be automatically turned on when the Power switch is turned on after the power was turned off by Power switch last time. Afterwards the POWER indicator will begin blinking in green. When the power is completely on, the indicator will stop blinking and light in green.

(2) When **AUTO ON in the OPTION menu is set to TURN OFF** (📖42): Please see step 3.

3. Press the STANDBY/ON button on the projector or the remote control.

To display the picture, select an input signal according to the section "Selecting an input signal" (📖18).

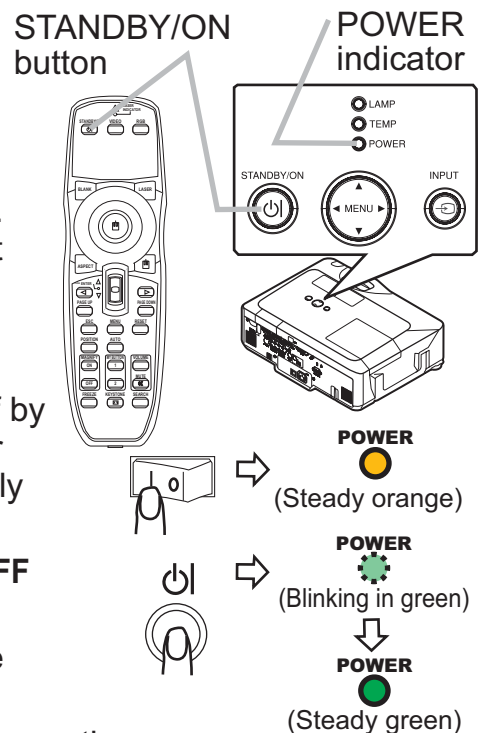

Turning off the power

1. Press the STANDBY/ON button on the projector or the remote control.
The message "Power off?" will appear on the screen for about 5 seconds.
2. Press the STANDBY/ON button on the projector or the remote control again while the message appears.
The projector lamp will go off, and the POWER indicator will begin blinking in orange.
Then the POWER indicator will stop blinking and light in steady orange when the lamp cooling is complete.

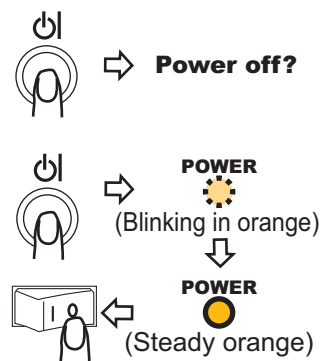

3. Make sure that the power indicator lights in steady orange, and set the power switch to the OFF position. The POWER indicator will go off. Attach the lens cover.

Do not turn the projector on for 10 minutes or more after turning it off. Turning the projector on again too soon could shorten the lifetime of some consumable parts of the projector.

⚠️WARNING ▶ A strong light is emitted when the projector's power is on. Do not look into the lens of the projector or look inside of the projector through any of the projector's openings.
▶ Do not touch around the lamp cover and the exhaust vents during use or just after use, since it is too hot.

NOTE • Turn the power on/off in right order. Please power on the projector prior to the connected devices. Power off the projector later than the connected devices.
• Use the shutdown switch (📖65) only when the projector is not turned off by normal procedure.

Operating

Adjusting the volume

1. Press the VOLUME button on the remote control.
 - A dialog will appear on the screen to aid you in adjusting the volume.
 2. Use the cursor buttons ▲/▼ to adjust the volume.
 - To close the dialog and complete the operation, press the VOLUME button again. Even if you do not do anything, the dialog will automatically disappear after a few seconds.
- When no audio port is selected for current picture input port, the volume adjustment is disable. Please see the AUDIO item of AUDIO menu. (P.37)

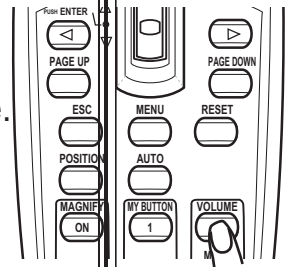

Temporarily muting the sound

1. Press the MUTE button on the remote control.
 - A dialog will appear on the screen indicating that you have muted the sound.
 - To restore the sound, press the MUTE or VOLUME button. Even if you do not do anything, the dialog will automatically disappear after a few seconds.
- As long as no audio input is selected for current picture input port, the sound is always muted. Please see the AUDIO item of AUDIO menu. (P.37)

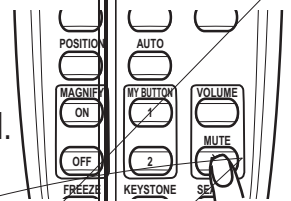

Selecting an input signal

1. Press the INPUT button on the projector.
 - Each time you press the button, the projector switches its input port as below.
- RGB 1 → RGB 2 → M1-D
 — VIDEO ← S-VIDEO ← COMPONENT (Y, CB/RB, CR/BR) ←
1. Press the RGB button on the remote control to select an input port for the RGB signal.
 - Each time you press the button, the projector switches its RGB input port as below.
- RGB 1 → RGB 2 → M1-D

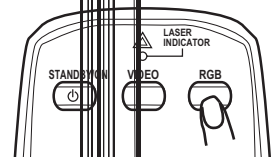
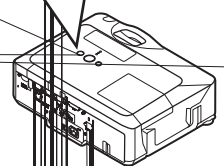

- If the RGB button is pushed (when switching from VIDEO to RGB signals) when TURN ON is selected for the AUTO SEARCH item in the OPTION menu the projector will check the RGB 1 port first. If no input is detected at the port, the projector will check other port in above order.

Selecting an input signal (continued)

1. Press the VIDEO button on the remote control to select an input for video signal.

Each time you press the button, the projector switches its video input port as below.

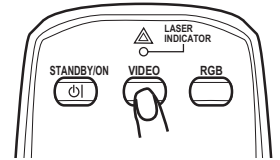

COMPONENT (Y, C_B/R_B, C_R/B_R) → S-VIDEO → VIDEO



- If the VIDEO button is pushed (when switching from RGB to VIDEO signals) when TURN ON is selected for the AUTO SEARCH item in the OPTION menu the projector will check the COMPONENT (Y, C_B/R_B, C_R/B_R) port first. If no input is detected at the port, the projector will check other ports in above order.

Searching an input signal

1. Press the SEARCH button on the remote control.
 - The projector will start to check its input ports in order to find any input signals.

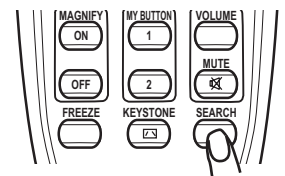

When an input is found, the projector will stop searching and display the image. If no signal is found, the projector will return to the state selected before the operation.

RGB 1 → RGB 2 → M1-D → COMPONENT (Y, C_B/R_B, C_R/B_R) → S-VIDEO → VIDEO



Selecting an aspect ratio

1. Press the ASPECT button on the remote control.
 - Each time you press the button, the projector switches the mode for aspect ratio in turn.

- For an RGB signal
NORMAL → 4:3 → 16:9 → SMALL



- For an M1-D signal
NORMAL → 4:3 → 16:9 → 14:9 → SMALL



- For a video signal, s-video signal or component video signal
4:3 → 16:9 → 14:9 → SMALL



- For no signal
4:3 (fixed)

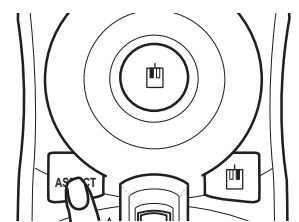

- The NORMAL mode keeps the original aspect ratio of the signal.
- Performing the automatic adjustment initializes the aspect ratio setting.

Adjusting the zoom and focus

1. Use the zoom ring to adjust the screen size.
2. Use the focus ring to focus the picture.

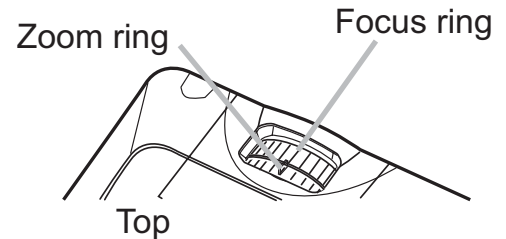

Adjusting the lens shift

1. Use the vertical lens shift dial to shift the picture upward or downward.
2. Use the horizontal lens shift dial to shift the picture left or right.

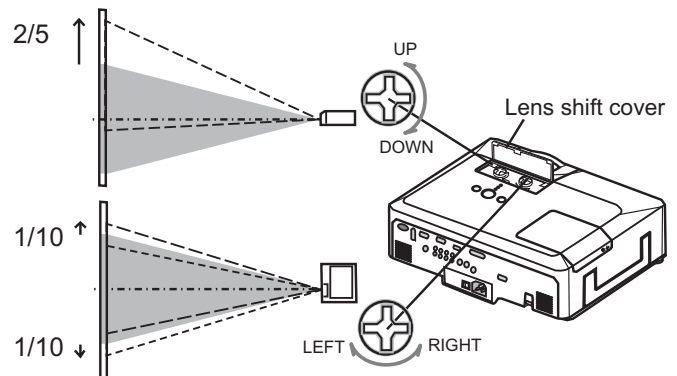

NOTE • When the vertical lens shift is adjusted, it is recommended to shift the picture upward.

Using the automatic adjustment feature

1. Press the AUTO button on the remote control.

○ For an RGB signal

The vertical position, the horizontal position, the horizontal phase and the horizontal size will be automatically adjusted.

And the aspect ratio will be automatically set to default. Make sure that the application window is set to its maximum size prior to attempting to use this feature. A dark picture may still be incorrectly adjusted. Use a bright picture when adjusting.

○ For an M1-D signal

The aspect ratio will be automatically set to default.

○ For a video signal or s-video signal

The video format best suited for the respective input signal will be selected automatically.

This function is available only when the AUTO is selected to the VIDEO FORMAT item in INPUT menu (32). For a component video signal, the signal type is identified automatically independently of this function.

○ For a video signal, s-video signal or component video signal

The vertical position, horizontal position and aspect ratio will be automatically set to default.

○ For a component video signal

The horizontal phase will be automatically set to default.

- The automatic adjustment operation requires about 10 seconds. Also please note that it may not function correctly with some input.

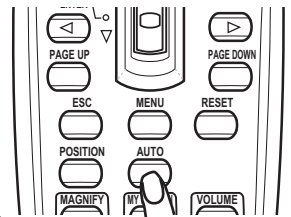

Adjusting the position

1. Press the POSITION button on the remote control.
The "POSITION" indication will appear on the screen.
2. Use the cursor buttons ▲/▼/◀/▶ to adjust the picture position.

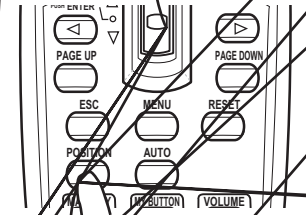

When you want to reset the operation, press the RESET button on the remote control during the operation.

To complete this operation, press the POSITION button again. Even if you do not do anything, the dialog will automatically disappear after a few seconds.

- When this function is performed on a video signal, s-video signal or component video signal, some image such as an extra-line may appear at outside of the picture.
- When this function is performed on a video signal, s-video signal, or component video signal of 525i (480i) or 625i (576i), the range of this adjustment depends on the OVER SCAN in IMAGE menu (📖 29) setting. It is not possible to adjust when the OVER SCAN is set to 10.

Using the magnify feature

1. Press the ON button of MAGNIFY on the remote control.
 - The “MAGNIFY” indication will appear on the screen (although the indication will disappear in several seconds with no operation), and the projector will go into the MAGNIFY mode.

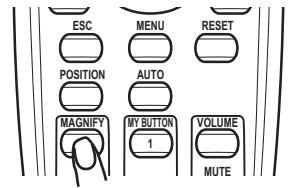

2. Use the cursor buttons ▲/▼ to adjust the zoom level.
 - To move the zoom area, press the POSITION button in the MAGNIFY mode, then use the cursor buttons ▲/▼/◀/▶ to move the area. And to finalize the zoom area, press the POSITION button again.
 - To exit from the MAGNIFY mode and restore the screen to normal, press the OFF button of MAGNIFY on the remote control.
- The projector automatically exits from the MAGNIFY mode when the input signal is changed, or when the display condition is changed.
 - Although in the MAGNIFY mode, the keystone distortion condition may vary, it will be restored when the projector exits from the MAGNIFY mode.

NOTE • The zoom level can be finely adjusted. Closely watch the screen to find the level you want.

Freezing the screen

1. Press the FREEZE button on the remote control.
 - The “FREEZE” indication will appear on the screen (although the indication will not appear when the TURN ON is selected to the MESSAGE item of SCREEN menu (📖41)), and the projector will go into the FREEZE mode.

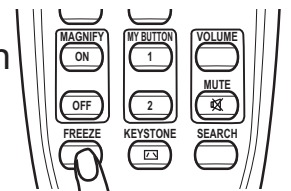

To exit the FREEZE mode and restore the screen to normal, press the FREEZE button again.

- The projector automatically exits from the FREEZE mode when the input signal changes, or when one of the projector’s buttons or the remote control buttons of STANDBY/ON, SEARCH, RGB, VIDEO, BLANK, AUTO, ASPECT, VOLUME, MUTE, KEYSTONE, POSITION, MENU, MAGNIFY and MY BUTTON is pressed.
- If the projector continues projecting a still image for a long time, the LCD panel might possibly be burned in. Do not leave the projector in the FREEZE mode for too long.

Temporarily blanking the screen

- 1 Press the BLANK button on the remote control.
 - The blank screen will be displayed instead of the screen of input signal. Please refer to the BLANK item in SCREEN menu (📖38).

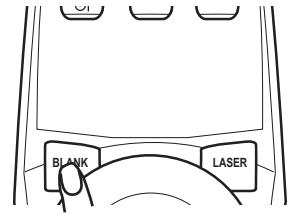

To exit from the blank screen and return to the input signal screen, press the BLANK button again.

- The projector automatically returns to the input signal screen when one of the projector's buttons or the remote control buttons is pressed or one of the commands (except get commands) is transmitted to the control port.

NOTE • The sound is not connected with the blank screen function. If necessary, set the volume or mute first.

Using the menu function

This projector has the following menus: PICTURE, IMAGE, INPUT, SETUP, AUDIO, SCREEN, OPTION, NETWORK, and EASY MENU. EASY MENU consists of functions often used, and the other menus are classified into each purpose. Each of these menus is operated using the same methods. The basic operations of these menus are as follows.

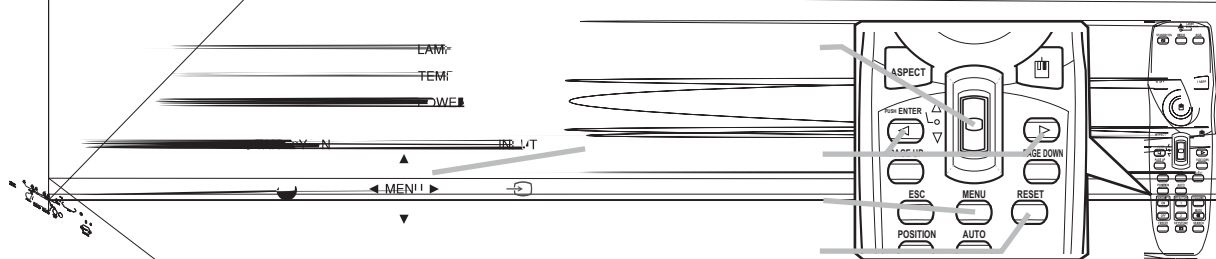

1. Press the MENU button on the remote control or one of the cursor buttons on the projector. The Advanced MENU, or EASY MENU that has priority just after powered on, will appear.

In the EASY MENU

2. If you want to change it to the Advanced MENU, select the "Go to Advanced Menu..."
3. Use the cursor buttons ▲/▼ to select an item to operate.
4. Use the cursor buttons ◀/▶ to operate the item.

In the Advanced MENU

2. Use the cursor buttons ▲/▼ to select a menu. If you want to change it to the EASY MENU, select the EASY MENU. Then press the cursor button ▶ on the projector or remote control, or the ENTER button on the remote control to select an item. The display of the selected menu will be active.
3. Use the cursor buttons ▲/▼ to select an item to operate. Then press the cursor button ▶ on the projector or remote control, or the ENTER button on the remote control to progress. The operation menu of the selected item will appear.
4. Use the cursor buttons ▲/▼ to operate the item.
 - When you want to reset the operation, press the RESET button on the remote control during the operation. Note that items whose functions are performed simultaneously with operation (ex. LANGUAGE, H PHASE, VOLUME etc.) cannot be reset.
 - In the Advanced MENU, when you want to return to the previous display, press the cursor button ◀ on the projector or remote control, or the ESC button on the remote control.
5. Press the MENU button on the remote control again to close the menu and complete this operation. Even if you do not do anything, the dialog will automatically disappear after about 10 seconds.
 - Some functions cannot be performed when a certain input port is selected, or when a certain input signal is displayed.

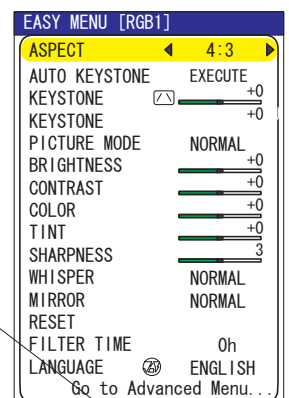





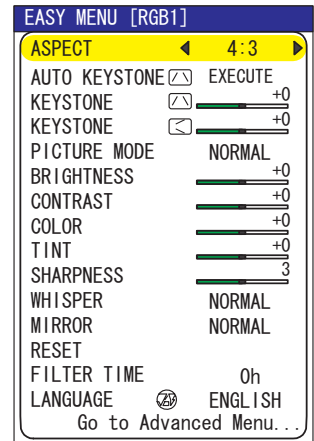

EASY Menu

From the EASY MENU, items shown in the table below can be performed.

Select an item using the ▲/▼ cursor buttons on the projector or remote control. Then perform it according to the following table.



| Item | Description | | | | | | | | | | | | | | | | | | | | | |
|--|---|------------|------------|-------|--------|-------------|------------|--------|-------------|------------|---------|--------------|------------|--------------|---------------------|------------|--------------|---------------------|------------|------------|-------------|------------|
| ASPECT | Using the ◀/▶ buttons switches the mode for aspect ratio. See the ASPECT item in IMAGE menu (📖29). | | | | | | | | | | | | | | | | | | | | | |
| AUTO KEYSTONE EXECUTE  | Using the ▶ button executes the auto keystone function. See the AUTO KEYSTONE  EXECUTE item in SETUP menu (📖35). | | | | | | | | | | | | | | | | | | | | | |
| KEYSTONE  | Using the ◀/▶ buttons corrects the vertical keystone distortion. See the KEYSTONE  item in SETUP menu (📖35). | | | | | | | | | | | | | | | | | | | | | |
| KEYSTONE  | Using the ◀/▶ buttons corrects the horizontal keystone distortion. See the KEYSTONE  item in SETUP menu (📖35). | | | | | | | | | | | | | | | | | | | | | |
| PICTURE MODE | <p>Using the ◀/▶ buttons switches the picture mode. The picture modes are combinations of GAMMA and COLOR TEMP settings. Choose a suitable mode according to the projected source.</p> <p>  </p> <table border="1"> <thead> <tr> <th></th> <th>COLOR TEMP</th> <th>GAMMA</th> </tr> </thead> <tbody> <tr> <td>NORMAL</td> <td>MID DEFAULT</td> <td>#1 DEFAULT</td> </tr> <tr> <td>CINEMA</td> <td>LOW DEFAULT</td> <td>#2 DEFAULT</td> </tr> <tr> <td>DYNAMIC</td> <td>HIGH DEFAULT</td> <td>#3 DEFAULT</td> </tr> <tr> <td>BOARD(BLACK)</td> <td>Hi-BRIGHT-1 DEFAULT</td> <td>#4 DEFAULT</td> </tr> <tr> <td>BOARD(GREEN)</td> <td>Hi-BRIGHT-2 DEFAULT</td> <td>#4 DEFAULT</td> </tr> <tr> <td>WHITEBOARD</td> <td>MID DEFAULT</td> <td>#5 DEFAULT</td> </tr> </tbody> </table> <ul style="list-style-type: none"> • When the combination of GAMMA and COLOR TEMP differs from pre-assigned modes above, the display on the menu for the PICTURE MODE is “CUSTOM”. Please refer to the GAMMA (📖26) and COLOR TEMP (📖27) items in PICTURE menu. • When this function is performed, a certain extra such as a line may appear. | | COLOR TEMP | GAMMA | NORMAL | MID DEFAULT | #1 DEFAULT | CINEMA | LOW DEFAULT | #2 DEFAULT | DYNAMIC | HIGH DEFAULT | #3 DEFAULT | BOARD(BLACK) | Hi-BRIGHT-1 DEFAULT | #4 DEFAULT | BOARD(GREEN) | Hi-BRIGHT-2 DEFAULT | #4 DEFAULT | WHITEBOARD | MID DEFAULT | #5 DEFAULT |
| | COLOR TEMP | GAMMA | | | | | | | | | | | | | | | | | | | | |
| NORMAL | MID DEFAULT | #1 DEFAULT | | | | | | | | | | | | | | | | | | | | |
| CINEMA | LOW DEFAULT | #2 DEFAULT | | | | | | | | | | | | | | | | | | | | |
| DYNAMIC | HIGH DEFAULT | #3 DEFAULT | | | | | | | | | | | | | | | | | | | | |
| BOARD(BLACK) | Hi-BRIGHT-1 DEFAULT | #4 DEFAULT | | | | | | | | | | | | | | | | | | | | |
| BOARD(GREEN) | Hi-BRIGHT-2 DEFAULT | #4 DEFAULT | | | | | | | | | | | | | | | | | | | | |
| WHITEBOARD | MID DEFAULT | #5 DEFAULT | | | | | | | | | | | | | | | | | | | | |

(continued on next page)

EASY Menu (continued)

| Item | Description |
|-------------------------------|--|
| BRIGHTNESS | Using the ◀/▶ buttons adjusts the brightness. See the BRIGHTNESS item in PICTURE menu (📖26). |
| CONTRAST | Using the ◀/▶ buttons adjusts the contrast. See the CONTRAST item in PICTURE menu (📖26). |
| COLOR | Using the ◀/▶ buttons adjusts the strength of whole color. See the COLOR item in PICTURE menu (📖27). |
| TINT | Using the ◀/▶ buttons adjusts the tint. See the TINT item in PICTURE menu (📖27). |
| SHARPNESS | Using the ◀/▶ buttons adjusts the sharpness. See the SHARPNESS item in PICTURE menu (📖27). |
| WHISPER | Using the ◀/▶ buttons turns off/on the whisper mode. See the WHISPER item in SETUP menu (📖36). |
| MIRROR | Using the ◀/▶ buttons switches the mode for mirror status. See the MIRROR item in SETUP menu (📖36). |
| RESET | Performing this item resets all of the EASY MENU items except the FILTER TIME and LANGUAGE. A dialog is displayed for confirmation. Selecting the RESET using the ▲ button performs resetting. |
| FILTER TIME | Performing this item resets the filter time which counts usage time of the air filter. A dialog is displayed for confirmation. Selecting the RESET using the ▲ button performs resetting. See the FILTER TIME item in OPTION menu (📖43). |
| LANGUAGE | Using the ◀/▶ buttons changes the display language. See the LANGUAGE item in SCREEN menu (📖38). |
| Go to Advanced Menu... | Select “Go to Advanced Menu...” on the menu, and press the ▶ or ENTER button to use the menu of PICTURE, IMAGE, INPUT, SETUP, AUDIO, SCREEN, OPTION or NETWORK. |

PICTURE Menu

From the PICTURE menu, items shown in the table below can be performed.

Select an item using the ▲/▼ cursor buttons on the projector or remote control, and press the ► cursor button on the projector or remote control, or the ENTER button on the remote control to execute the item. Then perform it according to the following table

| Item | Description |
|-------------------|--|
| BRIGHTNESS | Using the ▲/▼ buttons adjusts the brightness. Light ⇄ Dark |
| CONTRAST | Using the ▲/▼ buttons adjusts the contrast. Strong ⇄ Weak |
| GAMMA | <p>Using the ▲/▼ buttons switches the gamma mode. #1 DEFAULT ⇄ #1 CUSTOM ⇄ #2 DEFAULT ⇄ #2 CUSTOM ⇄ #3 DEFAULT #5 CUSTOM ⇄ #5 DEFAULT ⇄ #4 CUSTOM ⇄ #4 DEFAULT ⇄ #3 CUSTOM</p> <p>To adjust CUSTOM</p> <p>Selecting a mode whose name includes CUSTOM and then pressing the ► button or the ENTER button displays a dialog to aid you in adjusting the mode. This function is useful when you want to change the brightness of particular tones. Choose an item using the ◀/▶ buttons, and adjust the level using the ▲/▼ buttons. You can display a test pattern for checking the effect of your adjustment by pressing the ENTER button. Each time you press the ENTER button, the pattern changes as below.</p> <p>No pattern ⇄ Gray scale of 9 steps Ramp ⇄ Gray scale of 15 steps</p> <p>The eight equalizing bars correspond to eight tone levels of the test pattern except the darkest in the left end. If you want to adjust the 2nd tone from left end on the test pattern (Gray scale of 9 steps), use the equalizing adjustment bar “1”. The darkest tone at the left end of the test pattern cannot be controlled with any of equalizing adjustment bar.</p> <ul style="list-style-type: none"> • When this function is performed, lines or other distortion may appear. |

PICTURE Menu (continued)

| Item | Description |
|--------------------------|--|
| <p>COLOR TEMP</p> | <p>Using the ▲/▼ buttons switches the color temperature mode.</p> <p>→ HIGH DEFAULT ⇔ HIGH CUSTOM ⇔ MID DEFAULT ⇔ MID CUSTOM ← ↳ LOW DEFAULT ⇔ LOW CUSTOM ⇔ Hi-BRIGHT-1 DEFAULT ⇔ Hi-BRIGHT-1 CUSTOM ← ↳ Hi-BRIGHT-2 DEFAULT ⇔ Hi-BRIGHT-2 CUSTOM ←</p> <p>To adjust CUSTOM</p> <p>Selecting a mode whose name includes CUSTOM and then pressing the ► button or the ENTER button displays a dialog to aid you in adjusting the OFFSET and GAIN of the selected mode.</p> <p>OFFSET adjustments change the color intensity on the whole tones of the test pattern.</p> <p>GAIN adjustments mainly affect color intensity on the brighter tones of the test pattern.</p> <p>Choose an item using the ◀/▶ buttons, and adjust the level using the ▲/▼ buttons.</p> <p>You can display a test pattern for checking the effect of your adjustment by pressing the ENTER button. Each time you press the ENTER button, the pattern changes as below.</p> <p>No pattern ⇔ Gray scale of 9 steps ↘ ↗ Ramp ⇔ Gray scale of 15 steps</p> <ul style="list-style-type: none"> • When this function is performed, lines or other distortion may appear. |
| <p>COLOR</p> | <p>Using the ▲/▼ buttons adjusts the strength of whole color.</p> <p>Strong ⇔ Weak</p> <ul style="list-style-type: none"> • This item can be selected only for a video signal, s-video or component video signal. |
| <p>TINT</p> | <p>Using the ▲/▼ buttons adjusts the tint.</p> <p>Greenish ⇔ Reddish</p> <ul style="list-style-type: none"> • This item can be selected only for a video signal, s-video or component video signal. |
| <p>SHARPNESS</p> | <p>Using the ▲/▼ buttons adjusts the sharpness.</p> <p>Strong ⇔ Weak</p> <ul style="list-style-type: none"> • There may be some noise and/or the screen may flicker for a moment when an adjustment is made. This is not a malfunction. |

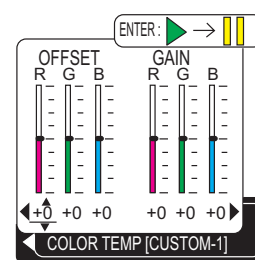

(continued on next page)

PICTURE Menu (continued)







| Item | Description | | | | | | | | |
|---------------------------|--|--|---------|--------------|---|---------|--|----------|---------------------------------|
| <p>ACTIVE IRIS</p> | <p>Using the ▲/▼ cursor buttons changes the active iris control mode. PRESENTATION ⇔ THEATER ⇔ TURN OFF</p>  <table border="1" data-bbox="456 479 1444 712"> <thead> <tr> <th></th> <th>Feature</th> </tr> </thead> <tbody> <tr> <td>PRESENTATION</td> <td>The active iris displays the best presentation image for both bright and dark scenes.</td> </tr> <tr> <td>THEATER</td> <td>The active iris displays the best theater image for both bright and dark scenes.</td> </tr> <tr> <td>TURN OFF</td> <td>The active iris is always open.</td> </tr> </tbody> </table> <ul style="list-style-type: none"> • The screen may flicker when the PRESENTATION or THEATER modes are selected. If this occurs select TURN OFF. | | Feature | PRESENTATION | The active iris displays the best presentation image for both bright and dark scenes. | THEATER | The active iris displays the best theater image for both bright and dark scenes. | TURN OFF | The active iris is always open. |
| | Feature | | | | | | | | |
| PRESENTATION | The active iris displays the best presentation image for both bright and dark scenes. | | | | | | | | |
| THEATER | The active iris displays the best theater image for both bright and dark scenes. | | | | | | | | |
| TURN OFF | The active iris is always open. | | | | | | | | |
| <p>MY MEMORY</p> | <p>This projector has 4 memories for adjustment data (for all the items of the PICTURE menu). Selecting a function using the ▲/▼ buttons and pressing the ► or ENTER button performs each function.</p>  <p><u>LOAD1, LOAD2, LOAD3, LOAD4</u></p> <p>Performing a LOAD function loads the data from the memory linked in the number included in the function's name, and adjusts the picture automatically depending on the data.</p> <ul style="list-style-type: none"> • The LOAD functions whose linked memory has no data are skipped. • Remember that the current adjusted condition will be lost by loading data. If you want to keep the current adjustment, please save it before performing a LOAD function. • There may be some noise and the screen may flicker for a moment when loading data. This is not malfunction. • The LOAD functions can be also performed by the MY MEMORY button which can be set by the MY BUTTON item in OPTION menu (44). <p><u>SAVE1, SAVE2, SAVE3, SAVE4</u></p> <p>Performing a SAVE function saves the current adjustment data into the memory linked in the number included in the function's name.</p> <ul style="list-style-type: none"> • Remember that the current data being stored of a memory will be lost by saving a new data into the memory. | | | | | | | | |

IMAGE Menu

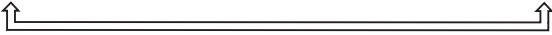
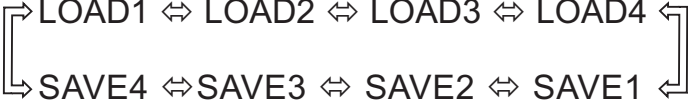
From the IMAGE menu, items shown in the table below can be performed.

Select an item using the ▲/▼ cursor buttons on the projector or remote control, and press the ► cursor button on the projector or remote control, or ENTER button on the remote control to execute the item. Then perform it according to the following table.

| MENU [RGB1] | | :SELECT |
|-------------|---------------------|---------|
| PICTURE | ASPECT | 4:3 |
| IMAGE | OVER SCAN | 5 |
| INPUT | V POSITION | 25 |
| SETUP | H POSITION | 142 |
| AUDIO | H PHASE | 16 |
| SCREEN | H SIZE | 1344 |
| OPTION | AUTO ADJUST EXECUTE | |
| NETWORK | | |
| EASY MENU | | |

| Item | Description |
|-------------------|--|
| ASPECT | <p>Using the ▲/▼ buttons switches the mode for aspect ratio.</p> <p>For an RGB signal NORMAL ⇔ 4:3 ⇔ 16:9 ⇔ SMALL </p> <p>For an M1-D signal NORMAL ⇔ 4:3 ⇔ 16:9 ⇔ 14:9 ⇔ SMALL </p> <p>For a Video signal, S-video signal or Component video signal 4:3 ⇔ 16:9 ⇔ 14:9 ⇔ SMALL </p> <p>For no signal 4:3 (fixed) • The NORMAL mode keeps the original aspect ratio of the signal.</p> |
| OVER SCAN | <p>Using the ▲/▼ buttons adjusts the over-scan ratio. Large (It reduces picture) ⇔ Small (It magnifies picture)</p> <ul style="list-style-type: none"> • This item can be selected only for a video, s-video and component signal. • When this adjustment is too large, certain degradation may appear at the frame area of the picture. In such a case, please adjust small. |
| V POSITION | <p>Using the ▲/▼ buttons adjusts the vertical position. Up ⇔ Down</p> <ul style="list-style-type: none"> • Over-adjusting the vertical position may cause noise to appear on the screen. If this occurs please reset the vertical position to the default setting. Pressing the RESET button when the V POSITION is selected will reset the V POSITION to the default setting. • When this function is performed on a video signal, s-video signal, or component video signal of 525i (480i) or 625i (576i), the range of this adjustment depends on the OVER SCAN (above) setting. It is not possible to adjust when the OVER SCAN is set to 10. |
| H POSITION | <p>Using the ▲/▼ buttons adjusts the horizontal position. Left ⇔ Right</p> <ul style="list-style-type: none"> • Over-adjusting the horizontal position may cause noise to appear on the screen. If this occurs please reset the horizontal position to the default setting. Pressing the RESET button when the H POSITION is selected will reset the H POSITION to the default setting. • When this function is performed on a video signal, s-video signal, or component video signal of 525i (480i) or 625i (576i), the range of this adjustment depends on the OVER SCAN (above) setting. It is not possible to adjust when the OVER SCAN is set to 10. |

(continued on next page)

IMAGE Menu (continued)

| Item | Description |
|-----------------------------------|--|
| <p>H PHASE</p> | <p>Using the ▲/▼ buttons adjusts the horizontal phase to eliminate flicker. Right ⇔ Left</p> <ul style="list-style-type: none"> • This item can be selected only for an RGB signal or a component video signal. (except 525i (480i), 625i (576i), SCART RGB) |
| <p>H SIZE</p> | <p>Using the ▲/▼ buttons adjusts the horizontal size. Large ⇔ Small</p> <ul style="list-style-type: none"> • This item can be selected only for an RGB signal. • When this adjustment is excessive, the picture may not be displayed correctly. In such a case, please reset the adjustment by pressing the RESET button on the remote control during this operation. |
| <p>AUTO ADJUST EXECUTE</p> | <p>Selecting this item performs the automatic adjustment feature.</p> <p>For an RGB signal The vertical position, the horizontal position, the horizontal phase and the horizontal size will be automatically set to default. And the aspect ratio will be automatically selected. Make sure that the application window is set to its maximum size prior to attempting to use this feature. A dark picture may still be incorrectly adjusted. Use a bright picture when adjusting.</p> <p>For an M1-D signal The aspect ratio will be automatically set to default.</p> <p>For a Video signal or S-video signal The video format best suited for the respective input signal will be selected automatically. This function is available only when the AUTO mode is selected to the VIDEO FORMAT item in INPUT menu. For a component video signal, the signal type is identified automatically independently of this function.</p> <p>For a Video signal, S-video signal or Component video signal The vertical position, horizontal position and aspect ratio will be automatically set to default.</p> <p>For a Component video signal The horizontal phase will be automatically set to default.</p> <ul style="list-style-type: none"> • The automatic adjustment operation requires about 10 seconds. Also please note that it may not function correctly with some input. |

INPUT Menu (continued)

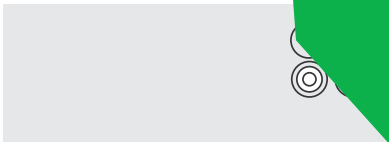
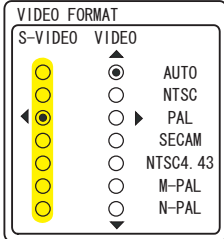
| Item | Description | | | | | | |
|----------------------------|--|--|---------|--------|-----------------------------------|----------|----------------------------------|
| <p>COMPONENT</p> | <p>Using the ▲/▼ buttons switches the function (Y, C_B/P_B, C_R/P_R) port.</p> <p>COMPONENT ⇔ SCART RGB</p> <p>When the SCART RGB is selected, the COMP (Y, C_B/P_B, C_R/P_R) and VIDEO ports will function as a SCART adapter or SCART cable is required for input to the projector. For details, contact your dealer.</p>  | | | | | | |
| <p>VIDEO FORMAT</p> | <p>Set the video format for the s-video port and video port.</p> <p>(1) Use the ◀/▶ buttons to select the input port.</p> <p>(2) Using the ▲/▼ buttons switches the mode for video format.</p> <p>AUTO ⇔ NTSC ⇔ PAL ⇔ SECAM ↗ N-PAL ⇔ M-PAL ⇔ NTSC4.43 ↖</p> <ul style="list-style-type: none"> • This item is performed only for a video signal from the VIDEO port or the S-VIDEO port. • The AUTO mode automatically selects the optimum mode. • The AUTO operation may not work well for some signals. If the picture becomes unstable (e.g. an irregular picture, lack of color), please select the mode according to the input signal.  | | | | | | |
| <p>M1-D</p> | <p>Using the ▲/▼ cursor buttons changes the M1-D signal mode.</p> <p>NORMAL ⇔ ENHANCED</p> <table border="1" data-bbox="453 1585 1442 1711"> <thead> <tr> <th></th> <th>Feature</th> </tr> </thead> <tbody> <tr> <td>NORMAL</td> <td>Suitable for DVD signals (16-235)</td> </tr> <tr> <td>ENHANCED</td> <td>Suitable for VGA signals (0-255)</td> </tr> </tbody> </table> <ul style="list-style-type: none"> • If the contrast of the screen image is too strong or too weak, try finding a more suitable mode. | | Feature | NORMAL | Suitable for DVD signals (16-235) | ENHANCED | Suitable for VGA signals (0-255) |
| | Feature | | | | | | |
| NORMAL | Suitable for DVD signals (16-235) | | | | | | |
| ENHANCED | Suitable for VGA signals (0-255) | | | | | | |



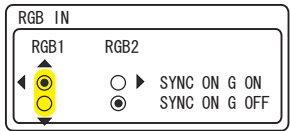

(continued on next page)

INPUT Menu (continued)

| Item | Description |
|--------------------------|--|
| <p>FRAME LOCK</p> | <p>Using the ▲/▼ buttons turns the frame lock function on/off. TURN ON ⇔ TURN OFF</p> <ul style="list-style-type: none"> • This item can be performed only on an RGB signal with a vertical frequency of 50 to 60 Hz. • When the TURN ON is selected, a moving pictures are displayed more smoothly. • This function may cause a certain degradation of the picture. In such a case, please select the TURN OFF. |
| <p>RGB IN</p> | <p>Set the RGB input signal type for the RGB port.</p> <p>(1) Use the ◀/▶ buttons to select the RGB port to be set. RGB1 ⇔ RGB2</p> <p>(2) Use the ▲/▼ buttons to select the RGB input signal type. SYNC ON G ON ⇔ SYNC ON G OFF</p> <ul style="list-style-type: none"> • Selecting the SYNC ON G ON turns the SYNC ON G mode on. The SYNC ON G mode allows reception of a sync on G signal. • In the SYNC ON G mode, the picture may be distorted with certain input signals. In such a case, remove the signal connector so that no signal is received and turn the SYNC ON G mode off, and then reconnect the signal.  |

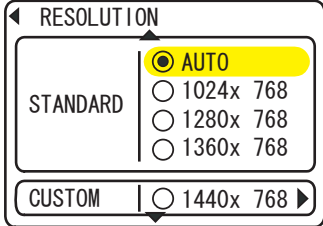
(continued on next page)

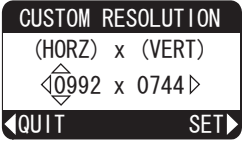
INPUT Menu (continued)

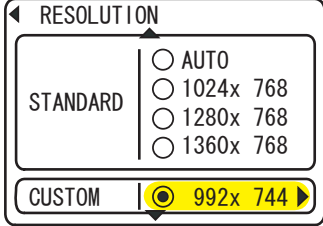
| Item | Description |
|--------------------------|--|
| <p>RESOLUTION</p> | <p>The resolution for the RGB1 and RGB2 input signals can be set on this projector.</p> <p>(1) In the INPUT menu select the RESOLUTION using the ▲/▼ buttons and press the ► button. The RESOLUTION menu will be displayed.</p>  <p>RESOLUTION MENU</p> <p>(2) In the RESOLUTION menu select the resolution you wish to display using the ▲/▼ buttons. Selecting AUTO will set a resolution appropriate to the input signal.</p> <p>(3) Pressing the ► or ENTER button when selecting a STANDARD resolution will automatically adjust the horizontal and vertical positions, clock phase and horizontal size and automatically select an aspect ratio. The INFORMATION dialog (📖46) will be displayed.</p>  <p>(4) To set a custom resolution use the ▲/▼ buttons to select the CUSTOM and the CUSTOM RESOLUTION BOX will be displayed. Set the horizontal (HORZ) and vertical (VERT) resolutions using the ▲/▼/◀/▶ buttons. Although not all resolutions are guaranteed.</p>  <p>CUSTOM RESOLUTION BOX</p> <p>(5) To save the setting place the cursor on the right-most digit and press the ► button. The horizontal and vertical positions, clock phase and horizontal size will be automatically adjusted and an aspect ratio will be automatically selected. After the INFORMATION(📖46) dialog has displayed for about 10 seconds the screen will return to the RESOLUTION menu displaying the changed resolution.</p>  <p>(6) To revert back to the previous resolution without saving changes place the cursor on the left-most digit and press the ◀ button. The screen will then return to the RESOLUTION menu displaying the previous resolution.</p>  <p>• For some pictures, this function may not work well.</p> |

SETUP Menu

From the SETUP menu, items shown in the table below can be performed.



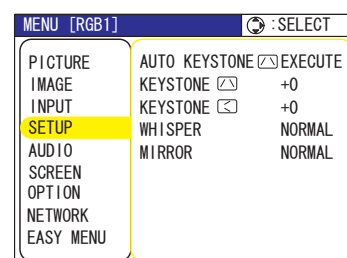



Select an item using the ▲/▼ cursor buttons on the projector or remote control, and press the ► cursor button on the projector or remote control, or the ENTER button on the remote control to execute the item. Then perform it according to the following table.

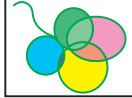

| Item | Description |
|--------------------------------------|---|
| <p>AUTO KEYSTONE EXECUTE </p> | <p>Selecting this item performs the Automatic keystone distortion correction. Projector automatically corrects vertical keystone distortion due to the (forward/backward) setup angle by itself.</p> <p>This function will be executed only once when selected in the Menu. When the slant of the projector is changed, executes this function again.</p> <ul style="list-style-type: none"> • The adjustable range of this function will vary among inputs. For some input, this function may not work well. • When V:INVERT or H&V:INVERT is selected to the MIRROR item in the SETUP menu, if the projector screen is inclined or angled downward, this function may not work correctly. • When the zoom adjustment is set to the TELE (telephoto focus), this function may be excessive. This function should be used when the zoom adjustment is set to the full WIDE (wide-angle focus) whenever possible. • When the projector is placed on the level (about $\pm 3^\circ$), this function may not work. • When the projector is inclined to near ± 30 degree or over, this function may not work well. • When the vertical lens shift is not set fully upward (not set fully downward for the optional lens type FL-601 only (45)), this function may not work well. • When the horizontal lens shift is not set to the center, this function may not work well. • This function will be unavailable when the Transition Detector is on (51). |
| <p>KEYSTONE </p> | <p>Using the ▲/▼ buttons corrects the vertical keystone distortion.</p> <p>Shrink the top of the image ⇔ Shrink the bottom of the image</p> <ul style="list-style-type: none"> • The adjustable range of this function will vary among inputs. For some input, this function may not work well. • When the vertical lens shift is not set fully upward (not set fully downward for the optional lens type FL-601 only (45)), this function may not work well. • When the horizontal lens shift is not set to the center, this function may not work well. • This function will be unavailable when the Transition Detector is on (51). |
| <p>KEYSTONE </p> | <p>Using the ▲/▼ buttons corrects the horizontal keystone distortion.</p> <p>Shrink the right of the image ⇔ Shrink the left of the image</p> <ul style="list-style-type: none"> • The adjustable range of this function will vary among inputs. For some input, this function may not work well. • When the horizontal lens shift is not set to the center, this function may not work well. • This function will be unavailable when the Transition Detector is on (51). |

(continued on next page)

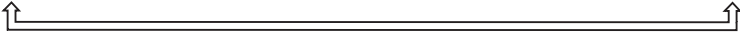
SETUP Menu (continued)

| Item | Description |
|-----------------------|--|
| <p>WHISPER</p> | <p>Using the ▲/▼ buttons turns off/on the whisper mode. NORMAL ⇔ WHISPER</p> <ul style="list-style-type: none"> • When the WHISPER is selected, acoustic noise and screen brightness are reduced. |
| <p>MIRROR</p> | <p>Using the ▲/▼ buttons switches the mode for mirror status.</p> <div style="display: flex; justify-content: space-around; align-items: center;">     </div> <p>NORMAL ⇔ H:INVERT ⇔ V:INVERT ⇔ H&V:INVERT</p> <div style="text-align: center;">  </div> <p>If the Transition Detector is TURN ON and MIRROR status is changed, Transition Detector Alarm ( 51) will be displayed when projector is restarted after the power switch is turned off.</p> |



AUDIO Menu

From the AUDIO menu, items shown in the table below can be performed.

Select an item using the ▲/▼ cursor buttons on the projector or remote control, and press the ► cursor button on the projector or remote control, or ENTER button on the remote control to execute the item. Then perform it according to the following table.

| MENU [RGB1] | | ◀ SELECT |
|--------------|---------|----------|
| PICTURE | VOLUME | 16 |
| IMAGE | TREBLE | +0 |
| INPUT | BASS | +0 |
| SETUP | SRS WOW | MID |
| AUDIO | SPEAKER | TURN ON |
| SCREEN | AUDIO | |
| OPTION | | |
| NETWORK | | |
| EASY MENU | | |

NOTE • The speaker sound may distorted or the case may be trembling when the volume is too high or treble/bass is emphasized or WOW is activated. In that case, make the volume reduced, bass/treble low or WOW effect to be weakend.

| Item | Description | | | | | | | | | | | | | | | | | | | | | | | | | | | | | | | | | | | | | | | | | | | | | | | | | | | | | | | | |
|---|--|-------|---|---|---|---|---|---|--------|--|--|--|--|--|--|------|---|---|---|---|---|---|------|---|---|---|---|---|---|------|---|---|---|---|---|---|-----------|---|---|---|---|---|---|---------|---|---|---|---|---|---|-------|---|---|---|---|---|---|
| VOLUME | Using the ▲/▼ buttons adjusts the volume. High ⇄ Low | | | | | | | | | | | | | | | | | | | | | | | | | | | | | | | | | | | | | | | | | | | | | | | | | | | | | | | | |
| TREBLE | Using the ▲/▼ buttons adjusts the treble level. High ⇄ Low | | | | | | | | | | | | | | | | | | | | | | | | | | | | | | | | | | | | | | | | | | | | | | | | | | | | | | | | |
| BASS | Using the ▲/▼ buttons adjusts the bass level. High ⇄ Low | | | | | | | | | | | | | | | | | | | | | | | | | | | | | | | | | | | | | | | | | | | | | | | | | | | | | | | | |
| SRS WOW  | Using the ▲/▼ buttons switches the mode for SRS WOW mode. HIGH ⇄ MID ⇄ OFF • SRS WOW™ accomplishes this by providing a panoramic three-dimensional audio image that extends the sound field in both the horizontal and vertical planes, and lowers the perceived bass response well beyond the low frequency limitations of the drivers. Adjust it depending on the user's preference. | | | | | | | | | | | | | | | | | | | | | | | | | | | | | | | | | | | | | | | | | | | | | | | | | | | | | | | | |
| SPEAKER | Using the ▲/▼ buttons turns the speaker function on/off. TURN ON ⇄ TURN OFF • When the TURN ON is selected the built-in speaker works. | | | | | | | | | | | | | | | | | | | | | | | | | | | | | | | | | | | | | | | | | | | | | | | | | | | | | | | | |
| AUDIO | Allocates the audio ports. (1) Choose a picture input port using the ▲/▼ buttons. <div style="text-align: center;">  </div> (2) Select the audio port to be interlocked with the input port using the ◀/▶ buttons. 1 ⇄ 2 ⇄ 3 ⇄ 4 ⇄ ✕ When ✕ is selected to an input port, any audio ports do not work interlocking with the input port, and any items in AUDIO menu are invalid. <div style="float: right; border: 1px solid black; padding: 5px; margin-top: 10px;"> <table border="1"> <thead> <tr> <th colspan="2">AUDIO</th> <th>1</th> <th>2</th> <th>3</th> <th>4</th> <th>✕</th> </tr> </thead> <tbody> <tr> <td>◀ QUIT</td> <td></td> <td></td> <td></td> <td></td> <td></td> <td></td> </tr> <tr> <td>RGB1</td> <td>◀</td> <td>●</td> <td>○</td> <td>○</td> <td>○</td> <td>○</td> </tr> <tr> <td>RGB2</td> <td>○</td> <td>●</td> <td>○</td> <td>○</td> <td>○</td> <td>○</td> </tr> <tr> <td>M1-D</td> <td>○</td> <td>○</td> <td>●</td> <td>○</td> <td>○</td> <td>○</td> </tr> <tr> <td>COMPONENT</td> <td>○</td> <td>○</td> <td>○</td> <td>●</td> <td>○</td> <td>○</td> </tr> <tr> <td>S-VIDEO</td> <td>○</td> <td>○</td> <td>○</td> <td>○</td> <td>●</td> <td>○</td> </tr> <tr> <td>VIDEO</td> <td>○</td> <td>○</td> <td>○</td> <td>○</td> <td>○</td> <td>●</td> </tr> </tbody> </table> </div> | AUDIO | | 1 | 2 | 3 | 4 | ✕ | ◀ QUIT | | | | | | | RGB1 | ◀ | ● | ○ | ○ | ○ | ○ | RGB2 | ○ | ● | ○ | ○ | ○ | ○ | M1-D | ○ | ○ | ● | ○ | ○ | ○ | COMPONENT | ○ | ○ | ○ | ● | ○ | ○ | S-VIDEO | ○ | ○ | ○ | ○ | ● | ○ | VIDEO | ○ | ○ | ○ | ○ | ○ | ● |
| AUDIO | | 1 | 2 | 3 | 4 | ✕ | | | | | | | | | | | | | | | | | | | | | | | | | | | | | | | | | | | | | | | | | | | | | | | | | | | |
| ◀ QUIT | | | | | | | | | | | | | | | | | | | | | | | | | | | | | | | | | | | | | | | | | | | | | | | | | | | | | | | | | |
| RGB1 | ◀ | ● | ○ | ○ | ○ | ○ | | | | | | | | | | | | | | | | | | | | | | | | | | | | | | | | | | | | | | | | | | | | | | | | | | | |
| RGB2 | ○ | ● | ○ | ○ | ○ | ○ | | | | | | | | | | | | | | | | | | | | | | | | | | | | | | | | | | | | | | | | | | | | | | | | | | | |
| M1-D | ○ | ○ | ● | ○ | ○ | ○ | | | | | | | | | | | | | | | | | | | | | | | | | | | | | | | | | | | | | | | | | | | | | | | | | | | |
| COMPONENT | ○ | ○ | ○ | ● | ○ | ○ | | | | | | | | | | | | | | | | | | | | | | | | | | | | | | | | | | | | | | | | | | | | | | | | | | | |
| S-VIDEO | ○ | ○ | ○ | ○ | ● | ○ | | | | | | | | | | | | | | | | | | | | | | | | | | | | | | | | | | | | | | | | | | | | | | | | | | | |
| VIDEO | ○ | ○ | ○ | ○ | ○ | ● | | | | | | | | | | | | | | | | | | | | | | | | | | | | | | | | | | | | | | | | | | | | | | | | | | | |

SCREEN Menu

From the SCREEN menu, items shown in the table below can be performed.

Select an item using the ▲/▼ cursor buttons on the projector or remote control, and press the ► cursor button on the projector or remote control, or ENTER button on the remote control to execute the item. Then perform it according to the following table.

| MENU [RGB1] | | ⊙:SELECT |
|---------------|---------------|----------|
| PICTURE | LANGUAGE | ENGLISH |
| IMAGE | MENU POSITION | |
| INPUT | BLANK | BLACK |
| SETUP | START UP | ORIGINAL |
| AUDIO | MyScreen | |
| SCREEN | MyScreen Lock | TURN OFF |
| OPTION | MESSAGE | TURN ON |
| NETWORK | SOURCE NAME | |
| EASY MENU | | |

| Item | Description | | | | | | | | |
|----------------------|--|--|---------|----------|--|----------|---------------------------------------|--------------------|------------------------------|
| LANGUAGE | <p>Using the ▲/▼ buttons switches the OSD (On Screen Display) language.</p> <p>ENGLISH ⇄ FRANÇAIS ⇄ DEUTSCH ⇄ ESPAÑOL ⇄ ITALIANO</p> <p>NORSK ⇄ NEDERLANDS ⇄ PORTUGUÊS ⇄ 日本語</p> <p>简体中文 ⇄ 繁體中文 ⇄ 한글 ⇄ SVENSKA ⇄ РУССКИЙ</p> <p>SUOMI ⇄ POLSKI ⇄ TÜRKÇE</p> | | | | | | | | |
| MENU POSITION | <p>Using the ◀/▶/▲/▼ buttons adjusts the menu position.</p> <p>To quit the operation, press the MENU button on the remote control or keep no operation for about 10 seconds.</p> | | | | | | | | |
| BLANK | <p>Using the ▲/▼ buttons switches the mode for the blank screen. The blank screen is a screen for the temporarily blanking feature (📖22). It is displayed by pressing the BLANK button on the remote control.</p> <p>MyScreen ⇄ ORIGINAL ⇄ BLUE ⇄ WHITE ⇄ BLACK</p> <table border="1"> <thead> <tr> <th></th> <th>Feature</th> </tr> </thead> <tbody> <tr> <td>MyScreen</td> <td>Screen can be registered by the MyScreen item (📖40).</td> </tr> <tr> <td>ORIGINAL</td> <td>Screen preset as the standard screen.</td> </tr> <tr> <td>BLUE, WHITE, BLACK</td> <td>Plain screens in each color.</td> </tr> </tbody> </table> <p>• To avoid remaining as an afterimage, the MyScreen or ORIGINAL screen will change to the plain black screen after several minutes.</p> | | Feature | MyScreen | Screen can be registered by the MyScreen item (📖40). | ORIGINAL | Screen preset as the standard screen. | BLUE, WHITE, BLACK | Plain screens in each color. |
| | Feature | | | | | | | | |
| MyScreen | Screen can be registered by the MyScreen item (📖40). | | | | | | | | |
| ORIGINAL | Screen preset as the standard screen. | | | | | | | | |
| BLUE, WHITE, BLACK | Plain screens in each color. | | | | | | | | |

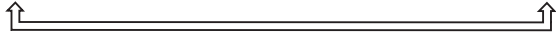

(continued on next page)

SCREEN Menu (continued)

| Item | Description | | | | | | | | |
|---|--|--|---------|----------|--|----------|---------------------------------------|----------|---------------------|
| START UP | Using the ▲/▼ buttons switches the mode for the start-up screen. The start-up screen is a screen displayed when no signal or an unsuitable signal is detected. | | | | | | | | |
| | MyScreen ⇔ ORIGINAL ⇔ TURN OFF  | | | | | | | | |
| | <table border="1" style="width: 100%; border-collapse: collapse;"> <thead> <tr> <th style="width: 50%;"></th> <th style="width: 50%;">Feature</th> </tr> </thead> <tbody> <tr> <td>MyScreen</td> <td>Screen can be registered by the MyScreen item (📖40).</td> </tr> <tr> <td>ORIGINAL</td> <td>Screen preset as the standard screen.</td> </tr> <tr> <td>TURN OFF</td> <td>Plain black screen.</td> </tr> </tbody> </table> | | Feature | MyScreen | Screen can be registered by the MyScreen item (📖40). | ORIGINAL | Screen preset as the standard screen. | TURN OFF | Plain black screen. |
| | | Feature | | | | | | | |
| | MyScreen | Screen can be registered by the MyScreen item (📖40). | | | | | | | |
| ORIGINAL | Screen preset as the standard screen. | | | | | | | | |
| TURN OFF | Plain black screen. | | | | | | | | |
| <ul style="list-style-type: none"> • To avoid remaining as an afterimage, the MyScreen or ORIGINAL screen will change to the BLANK screen (📖38) after several minutes. If also the BLANK screen is the MyScreen or ORIGINAL, the plain black screen is instead used. | | | | | | | | | |
| <ul style="list-style-type: none"> • When the TURN ON is selected to the MyScreen PASSWORD of SECURITY item in OPTION menu (📖48), the START UP is fixed to MyScreen. | | | | | | | | | |



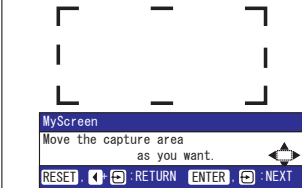





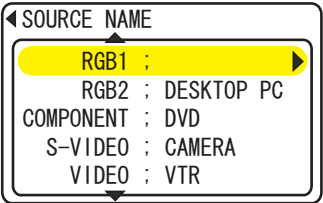
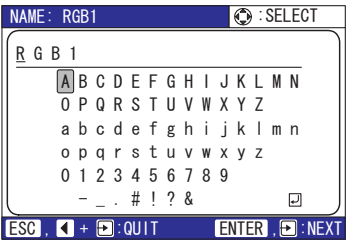

(continued on next page)

SCREEN Menu (continued)

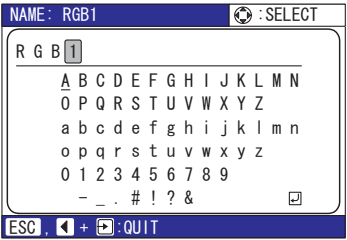
| Item | Description |
|-----------------------------|---|
| <p>MyScreen</p> | <p>This item allows you to capture an image for use as a MyScreen image which can be used as the BLANK screen and START UP screen. Display the image you want to capture before executing the following procedure.</p> <ol style="list-style-type: none"> <p>Selecting this item displays a dialog titled "MyScreen". It will ask you if you start capturing an image from the current screen.</p>  <p>Please wait for the target image to be displayed, and press the ENTER button on the remote control when the image is displayed. The image will freeze and the frame for capturing will appear.</p> <p>To stop performing, press the RESET or ESC button on the remote control.</p> <p>Using the ▲/▼/◀/▶ buttons adjusts the frame position.</p>  <p>Please move the frame to the position of the image which you want to use. The frame may not be able to be moved for some input signals.</p>  <p>To start registration, press the ENTER button on the remote control.</p> <p>To restore the screen and return to the previous dialog, press the RESET or ESC button on the remote control.</p> <p>Registration takes several minutes.</p> <p>When the registration is completed, the registered screen and the following message is displayed for several seconds:</p> <pre>Í AmGWfYYb`fY []ghfUh]cb`]g`Üb]g\YX"Î</pre> <p>If the registration failed, the following message is displayed:</p> <pre>Í 5`WUdh i f]b [`Yffc' \Ug`cWW i ffYX" D`YUgY`hfm`U [U]b"Î`</pre> <ul style="list-style-type: none"> • This item cannot be selected for an M1-D signal. • This function cannot be selected when the TURN ON is selected to the MyScreen Lock item (see below). • This function cannot be selected when the TURN ON is selected to the MyScreen PASSWORD of SECURITY item in OPTION menu (see 48). |
| <p>MyScreen Lock</p> | <p>Using the ▲/▼ buttons turns on/off the MyScreen lock function.</p> <p>TURN ON ⇔ TURN OFF</p> <p>When the TURN ON is selected, the item MyScreen is locked. Use this function for protecting the current MyScreen.</p> <ul style="list-style-type: none"> • This function cannot be selected when the TURN ON is selected to the MyScreen PASSWORD of SECURITY item in OPTION menu (see 48). |

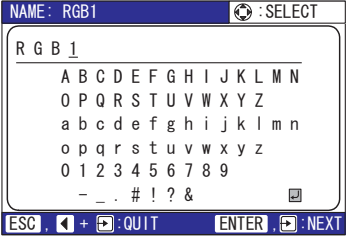
(continued on next page)

SCREEN Menu (continued)

| Item | Description |
|---------------------------|--|
| <p>MESSAGE</p> | <p>Using the ▲/▼ buttons turns on/off the message function. TURN ON ⇔ TURN OFF</p> <p>When the TURN ON is selected, the following message function works. “AUTO IN PROGRESS” while automatically adjusting “NO INPUT IS DETECTED” “SYNC IS OUT OF RANGE” “Searching...” while searching for the input “Detecting...” while an input signal is detected</p> <p>The indication of the input signal displayed by changing The indication of the aspect ratio displayed by changing The indication of the PICTURE MODE displayed by changing The indication of the ACTIVE IRIS displayed by changing The indication of the MY MEMORY displayed by changing The indication of "FREEZE" and "II" while freezing the screen by pressing the FREEZE button.</p> <ul style="list-style-type: none"> • When the TURN OFF is selected, please remember if the picture is freezing. Do not mistake freezing for a malfunction (📖21). |
| <p>SOURCE NAME</p> | <p>Each input port for this projector can have a name applied to it.</p> <p>(1) Use the ▲/▼ buttons on the SCREEN menu to select SOURCE NAME and press the ► button. The SOURCE NAME menu will be displayed.</p> <p>(2) Use the ▲/▼ buttons on the SOURCE NAME menu to select the port to be named and press the ► button. Right side of the menu is blank until a name is specified. The SOURCE NAME dialog will be displayed.</p> <p>(3) The current name will be displayed on the first line. Use the ▲/▼/◀/▶ buttons and the ENTER or INPUT button to select and enter characters. The RESET button can be used to erase 1 character at a time. The name can be a maximum of 16 characters.</p> <p>(4) To change an already inserted character, press the ▲ button while the cursor is on the [A-N] row to move the cursor to the name displayed on the first line and use the ◀/▶ buttons to select character to be changed. Once a character in the name is selected use the ▼ button to move the cursor back down to the character entry area to select and enter characters as described above.</p> <p>(5) Select  and press the ENTER or INPUT buttons when finished entering text. To revert to the previous name without saving changes press the ESC or ◀ button and the INPUT button simultaneously.</p> <div data-bbox="1141 1055 1465 1256">  <p>◀ SOURCE NAME RGB1 ; RGB2 ; DESKTOP PC COMPONENT ; DVD S-VIDEO ; CAMERA VIDEO ; VTR</p> </div> <div data-bbox="1125 1279 1473 1518">  <p>NAME: RGB1 Ⓞ :SELECT R G B 1 A B C D E F G H I J K L M N O P Q R S T U V W X Y Z a b c d e f g h i j k l m n o p q r s t u v w x y z 0 1 2 3 4 5 6 7 8 9 - . # ! ? & </p> <p>ESC, ◀ +  : QUIT ENTER,  : NEXT</p> </div> <div data-bbox="1125 1541 1473 1780">  <p>NAME: RGB1 Ⓞ :SELECT R G B 1 A B C D E F G H I J K L M N O P Q R S T U V W X Y Z a b c d e f g h i j k l m n o p q r s t u v w x y z 0 1 2 3 4 5 6 7 8 9 - . # ! ? & </p> <p>ESC, ◀ +  : QUIT</p> </div> <div data-bbox="1125 1803 1473 2042">  <p>NAME: RGB1 Ⓞ :SELECT R G B 1 A B C D E F G H I J K L M N O P Q R S T U V W X Y Z a b c d e f g h i j k l m n o p q r s t u v w x y z 0 1 2 3 4 5 6 7 8 9 - . # ! ? & </p> <p>ESC, ◀ +  : QUIT ENTER,  : NEXT</p> </div> |

OPTION Menu

From the OPTION menu, items shown in the table below can be performed.

Select an item using the ▲/▼ cursor buttons on the projector or remote control, and press the ► cursor button on the projector or remote control, or ENTER button on the remote control to execute the item, except for the items LAMP TIME and FILTER TIME. Then perform it according to the following table.

| MENU [RGB1] | | ⊙:SELECT |
|---------------|---------------|----------|
| PICTURE | AUTO SEARCH | TURN OFF |
| IMAGE | AUTO KEYSTONE | TURN OFF |
| INPUT | AUTO ON | TURN OFF |
| SETUP | AUTO OFF | 0min |
| AUDIO | LAMP TIME | 0h |
| SCREEN | FILTER TIME | 0h |
| OPTION | MY BUTTON | |
| NETWORK | SERVICE | |
| EASY MENU | SECURITY | |

| Item | Description |
|----------------------|---|
| AUTO SEARCH | <p>Using the ▲/▼ buttons turns on/off the automatic signal search function. TURN ON ⇔ TURN OFF</p> <p>When the TURN ON is selected, detecting no signal automatically cycles through input ports in the following order. The search is started from the current port. Then when an input is found, the projector will stop searching and display the image.</p> <p>RGB 1 ⇒ RGB 2 ⇒ M1-D ⇒ COMPONENT ⇒ S-VIDEO ⇒ VIDEO</p> |
| AUTO KEYSTONE | <p>Using the ▲/▼ buttons turns on/off the automatic keystone function. TURN ON ⇔ TURN OFF</p> <p>TURN ON : Automatic keystone distortion correction will be executed whenever changing the slant of the projector.</p> <p>TURN OFF : This function is disabled. Please execute the AUTO KEYSTONE EXECUTE in the SETUP Menu for automatic keystone distortion correction.</p> <ul style="list-style-type: none"> • When the projector is suspended from the ceiling this feature will not function properly so select the TURN OFF. • This function will be unavailable when the Transition Detector is on (51). |
| AUTO ON | <p>Using the ▲/▼ buttons turns on/off the AUTO ON function. TURN ON ⇔ TURN OFF</p> <p>When set to the TURN ON, the lamp in projector will be automatically turned on without the usual procedure, only when the projector is supplied with the power.</p> <ul style="list-style-type: none"> • This function does not work as long as the power has been supplied to the projector while the lamp is off. • After turning the lamp on by the AUTO ON function, if neither input nor operation is detected for about 30 minutes, the projector is turned off, even though the AUTO OFF function (43) is disabled. |

(continued on next page)

OPTION Menu (continued)

| Item | Description |
|---------------------------|--|
| <p>AUTO OFF</p> | <p>Using the ▲/▼ buttons adjusts the time to count down to automatically turn the projector off. Long (max. 99 minutes) ⇔ Short (min. 0 minute = DISABLE)</p> <div style="display: flex; justify-content: space-around; align-items: center;"> <div style="border: 1px solid black; padding: 5px; text-align: center;"> <p>◀ AUTO OFF ENABLE ▲ 1 ▼</p> </div> <div style="border: 1px solid black; padding: 5px; text-align: center;"> <p>◀ AUTO OFF DISABLE ▲ 0 ▼</p> </div> </div> <p>When the time is set to 0, the projector is not turned off automatically. When the time is set to 1 to 99, and when the passed time with no-signal or an unsuitable signal reaches at the set time, the projector lamp will be turned off. If one of the projector's buttons or the remote control buttons is pressed or one of the commands (except get commands) is transmitted to the control port during the corresponding time, projector will not be turned off. Please refer to the section "Turning off the power" (📖16).</p> |
| <p>LAMP TIME</p> | <p>The lamp time is the time counted after the last resetting. It is shown in the OPTION menu as the usage time of the lamp. Pressing the RESET button on the remote control or the ► button of the projector displays a dialog. To reset the lamp time, select the RESET using the ▲ button. RESET ⇔ CANCEL</p> <ul style="list-style-type: none"> • Please reset the lamp time only when you have replaced the lamp, for a suitable indication about the lamp. • For the lamp replacement, see the section "Lamp" (📖56, 57). |
| <p>FILTER TIME</p> | <p>The filter time is the time counted after the last resetting. It is shown in the OPTION menu as the usage time of the air filter. Pressing the RESET button on the remote control or the ► button of the projector displays a dialog. To reset the filter time, select the RESET using the ▲ button. RESET ⇔ CANCEL</p> <ul style="list-style-type: none"> • Please reset the filter time only when you have cleaned or replaced the air filter, for a suitable indication about the air filter. • For the air filter cleaning, see the section "Air filter" (📖58, 59). |

(continued on next page)

| Item | Description |
|-------------------------|---|
| <p>MY BUTTON</p> | <p>This item is to assign one of the following function to MY BUTTON 1 and 2 on the remote control (📖6).</p> <p>Choose 1 or 2 on the MY BUTTON menu using the ◀/▶ button first. Then using the ▲/▼ buttons sets one of the following functions to the chosen button.</p> <ul style="list-style-type: none"> • RGB1: Sets port to RGB1. • RGB2: Sets port to RGB2. • M1-D: Sets port to M1-D. • COMPONENT: Sets port to COMPONENT (Y, C_B/P_B, C_R/P_R). • S-VIDEO: Sets port to S-VIDEO. • VIDEO: Sets port to VIDEO. • e-SHOT: Displays the e-SHOT menu (📖54). • INFORMATION: Displays a dialog of INPUT INFORMATION (📖46). • AUTO KEYSTONE |
| | |

OPTION Menu (continued)

| Item | Description |
|-----------------------|--|
| <p>SERVICE</p> | <p>AUTO ADJUST Using the ▲/▼ buttons enables/disables the automatic adjustment. When DISABLE is selected, the automatic adjustment feature is disabled, although rough adjustment is automatically performed depending on the basic setting. ENABLE ⇔ DISABLE</p> <ul style="list-style-type: none"> Depending on conditions, such as input image, signal cable to the projector, environment around the projector, etc., the automatic adjustment may not work correctly. In such a case, please choose DISABLE to disable the automatic adjustment, and make adjustment manually. |
| | <p>GHOST 1. Select a color element of ghost using the ◀/▶ buttons. 2. Adjust the selected element using the ▲/▼ buttons to disappear ghost.</p> |
| | <p>FILTER MESSAGE Use the ▲/▼ button to set the timer for the interval to show the message for cleaning up the air filter. 50h ⇔ 100h ⇔ 200h ⇔ 300h ⇔ TURN OFF After selecting “50h”, “100h”, “200h”, or “300h”, the message “REMINDER *** HRS PASSED AFTER THE LAST FILTER CHECK” will appear after the timer reaches the interval time set by the menu. (62) When the “TURN OFF” is chosen, the air filter cleaning message will not appear.</p> <ul style="list-style-type: none"> Please check and clean the air filter periodically, even if there is no message. If the air filter becomes to be blocked by dust or others, the internal temperature will rise, which could cause malfunction, or reduce the lifetime of the projector. It is recommended to choose “100h” in general. Please be careful with the operating environment of the projector and the condition of the air filter, especially when the “200h”, “300h” or “TURN OFF” is chosen. |
| | <p>LENS TYPE Select the lens type currently used using the ▲/▼ buttons. 1 ⇔ 2 ⇔ 3 ⇔ 4 ⇔ 5 Please select one of them referring to the following. 1: for a standard lens (Type NL-600) 2: for a fixed short throw lens (Type FL-601) 3: for a short throw lens (Type SL-602) 4: for a long throw lens (Type LL-603) 5: for an ultra long throw lens (Type UL-604)</p> <ul style="list-style-type: none"> This setting has an influence on the keystone distortion etc. About the optional lens, ask you dealer. |

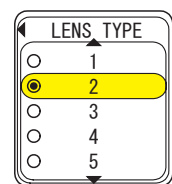
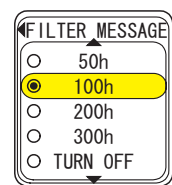
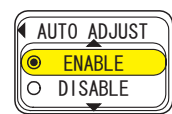

(continued on next page)

OPTION Menu (continued)

| Item | Description |
|-----------------------|--|
| <p>SERVICE</p> | <p>KEY LOCK Using the ▲/▼ buttons turns on/off the key lock feature. When TURN ON is selected, the buttons on the projector except the STANDBY/ON button are locked. TURN ON ⇔ TURN OFF</p> <ul style="list-style-type: none"> • Please use to avoid a mischief and touching accidentally. This function does not have any effect on the remote control. <p>REMOTE RECEIV. (1) Select a remote sensor using the ▲/▼ button. 1:FRONT ⇔ 2:TOP ⇔ 3:REAR (2) Switch it using the ENTER button <input type="checkbox"/> (off) ⇔ <input checked="" type="checkbox"/> (on)</p> <ul style="list-style-type: none"> • A sensor cannot be turned off when the other two are off. Always at least one sensor is on. <p>REMOTE FREQ. Use the ▲/▼ button to change the Projector's remote sensor setting (📖14). 1:NORMAL ⇔ 2:HIGH</p> <p>Items with a checkmark are on. The factory default setting is for both 1:NORMAL and 2: HIGH to be on. If the remote control does not function correctly set the this to either only 1 or only 2 as described in Remote Control Settings (📖14). Neither can be turned off at the same time.</p> <p>INFORMATION Selecting this item displays a dialog titled "INPUT INFORMATION". It shows the information about the current input.</p> <div style="display: flex; justify-content: space-around; align-items: flex-start;"> <div style="border: 1px solid black; padding: 5px; text-align: center; width: 30%;"> <small>◀ INPUT-INFORMATION</small> RGB1 1024x768 @60Hz FRAME LOCK </div> <div style="border: 1px solid black; padding: 5px; text-align: center; width: 30%;"> <small>◀ INPUT-INFORMATION</small> S-VIDEO SECAM AUTO </div> <div style="border: 1px solid black; padding: 5px; text-align: center; width: 30%;"> <small>◀ INPUT-INFORMATION</small> COMPONENT 576i @50 SCART RGB </div> </div> <ul style="list-style-type: none"> • The "FRAME LOCK" message on the dialog means the frame lock function is working. • The "SCART RGB" message means the COMPONENT VIDEO port is working as a SCART RGB input port. Please refer to the COMPONENT item in INPUT menu (📖32). • This item can't be selected for no signal and sync out. <p>FACTORY RESET Selecting RESET using the button ▲ performs this function. By this function, all the items in all of menus will collectively return to the initial setting. Note that the items LAMP TIME, FILTER TIME, LANGUAGE and SECURITY are not reset. RESET ⇔ CANCEL</p> |

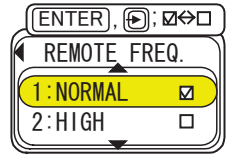
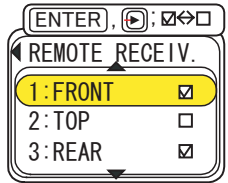

(continued on next page)

OPTION Menu (continued)

| Item | Description |
|------------------------|---|
| <p>SECURITY</p> | <p>This projector is equipped with security functions. User registration is required before using the security functions. Please contact your local dealer.</p> <p>1. Using Security Features</p> <p>1.1 Inputting the PASSWORD</p> <p>1.1-1 Use the ▲/▼ buttons on the OPTION menu to select SECURITY and press the ► button. The ENTER PASSWORD box will be displayed. The factory default PASSWORD is 2400. This PASSWORD can be changed (1.2 Changing the PASSWORD).</p> <ul style="list-style-type: none"> It is strongly recommended the factory default PASSWORD to be changed as soon as possible. <p>1.1-2 Use the ▲/▼/◀/▶ buttons to enter the registered PASSWORD. Move the cursor to the right side of the ENTER PASSWORD BOX and press the ► button to display the SECURITY menu. If an incorrect PASSWORD is input the ENTER PASSWORD BOX will be displayed again. If incorrect PASSWORD is input 3 times the projector will turn off. Afterwards the projector will turn off every time an incorrect PASSWORD is input.</p> <p>1.2 Changing the PASSWORD</p> <p>1.2-1 Use the ▲/▼ buttons on the SECURITY menu to select SECURITY PASSWORD CHANGE and press the ► button to display the ENTER NEW PASSWORD BOX.</p> <p>1.2-2 Use the ▲/▼/◀/▶ buttons to enter the new PASSWORD.</p> <p>1.2-3 Move the cursor to the right side of the ENTER NEW PASSWORD BOX and press the ► button to display the NEW PASSWORD AGAIN BOX, enter the same PASSWORD again.</p> <p>1.2-4 Move the cursor to the right side of the NEW PASSWORD AGAIN BOX and press the ► button and the NOTE NEW PASSWORD BOX will be displayed for about 20 seconds, please make note of the PASSWORD during this time. Pressing the ENTER button on the remote control or INPUT button on the projector will close the NOTE NEW PASSWORD BOX.</p> <ul style="list-style-type: none"> Please do not forget your PASSWORD. |



ENTER PASSWORD BOX

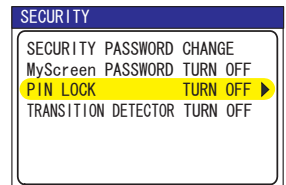

SECURITY MENU



ENTER NEW PASSWORD BOX



NEW PASSWORD AGAIN BOX



NOTE NEW PASSWORD BOX

(continued on next page)

OPTION Menu (continued)

| Item | Description |
|------------------------|--|
| <p>SECURITY</p> | <p>1.3 If you have forgotten your PASSWORD</p> <p>1.3-1 Follow the procedure in 1.1-1 to display the ENTER PASSWORD BOX.</p> <p>1.3-2 While the ENTER PASSWORD BOX is displayed, press and hold the RESET button on the remote control for about 3 seconds or press and hold the INPUT and ► buttons on the projector for about 3 seconds.</p> <p>The 10 digit Inquiring Code will be displayed.</p> <p>NOTE: If there is no key input for about 55 seconds while the Inquiring Code is displayed the menu will close. If necessary repeat the process from 1.3-1.</p> <p>1.3-3 Contact your dealer with the 10 digit Inquiring Code. Your PASSWORD will be sent after your user registration information is confirmed.</p> <p>2. Using the MyScreen PASSWORD Function</p> <p>The MyScreen PASSWORD function can be used to prohibit access to the MyScreen function and prevent the currently registered MyScreen image from being overwritten.</p> <p>2.1 Turning on the MyScreen PASSWORD Function</p> <p>2.1-1 Use the ▲/▼ buttons on the SECURITY menu to select MyScreen PASSWORD and press the ► button to display the MyScreen PASSWORD on/off menu.</p> <p>2.2 Setting the PASSWORD</p> <p>2.2-1 Display the MyScreen on/off menu using the procedure in 2.1-1.</p> <p>2.2-2 Use the ▲/▼ buttons on the MyScreen PASSWORD on/off menu to select TURN ON. The ENTER PASSWORD BOX (small) will be displayed.</p> <p>2.2-3 Use the ▲/▼/◀/▶ buttons to enter the PASSWORD. Move the cursor to the right side of the ENTER PASSWORD BOX (small) and press the ► button to display the CHECK PASSWORD BOX, enter the same PASSWORD again.</p> |



Inquiring Code (PASSWORD)

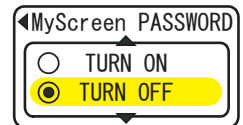

MyScreen PASSWORD on/off menu

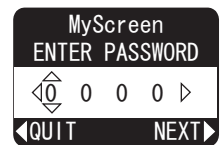

ENTER PASSWORD BOX (small)

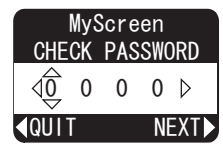

CHECK PASSWORD BOX

(continued on next page)

OPTION Menu (continued)

| Item | Description |
|------------------------|--|
| <p>SECURITY</p> | <p>2.2-4 Move the cursor to the right side of the CHECK PASSWORD BOX and press the ► button to display the PASSWORD for about 20 seconds, please make note of the PASSWORD during this time.</p> <p>Pressing the ENTER button on the remote control or INPUT button on the projector will return to MyScreen PASS WORD on/off menu.</p> <p>When a PASSWORD is set for MyScreen:</p> <ul style="list-style-type: none"> • The MyScreen registration function (and menu) will be unavailable. • The MyScreen Lock function (and menu) will be unavailable. • The START UP setting will be locked on MyScreen (and the menu will be unavailable). <p>Turning the MyScreen PASSWORD off will allow normal operation of both functions.</p> <ul style="list-style-type: none"> • Please do not forget your MyScreen PASSWORD. <p>2.3 Turning the PASSWORD off</p> <p>2.3-1 Follow the procedure in 2.1-1 to display the MyScreen PASSWORD on/off menu.</p> <p>2.3-2 Select TURN OFF to display the ENTER PASSWORD BOX (large). Enter the registered PASSWORD and the screen will return to the MyScreen on/off menu.</p> <p>If an incorrect PASSWORD is input the menu will close. If necessary repeat the process from 2.3-1.</p> |
| | <p>2.4 If you have forgotten your PASSWORD</p> <p>2.4-1 Follow the procedure in 2.1-1 to display the MyScreen PASSWORD on/off menu.</p> <p>2.4-2 Select TURN OFF to display the ENTER PASSWORD BOX (large). The 10 digit Inquiring Code will be displayed inside the BOX.</p> <p>2.4-3 Contact your dealer with the 10 digit Inquiring Code. Your PASSWORD will be sent after your user registration information is confirmed.</p> <p>3. Using the PIN LOCK Function</p> <p>PIN LOCK is a function which prevents the projector from being used unless a registered Code is input.</p> <p>3.1 Registering the PIN Code</p> <p>3.1-1 Use the ▲/▼ buttons on the SECURITY menu to select PIN LOCK and press the ► button or the ENTER button to display the PIN LOCK on/off menu.</p> <p>3.1-2 Use the ▲/▼ buttons on the PIN LOCK on/off menu to select TURN ON and the PIN BOX will be displayed.</p> |

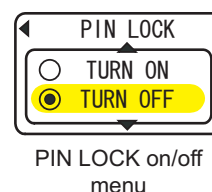
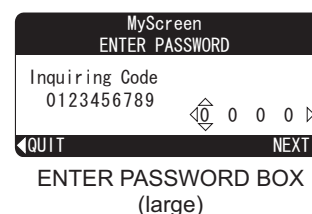
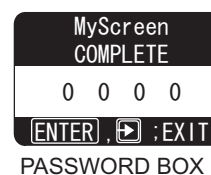

(continued on next page)

OPTION Menu (continued)

| Item | Description |
|------------------------|--|
| <p>SECURITY</p> | <p>3.1-3 Input a 4 part PIN Code using the ▲/▼/◀/▶ /RGB and INPUT buttons. A CONFIRMATION BOX will appear. Reenter the same PIN Code. This will complete the PIN Code registration. NOTE: If there is no key input for about 55 seconds while the PIN BOX or the CONFIRMATION BOX are displayed the menu will close. If necessary repeat the process from 3.1-1. Afterwards, anytime the projector is restarted after the power switch is turned off the PIN BOX will be displayed. Enter the registered PIN Code. The projector can be used after entering the registered PIN Code. If an incorrect PIN Code is input the PIN BOX will be displayed again. If an incorrect PIN Code is input 3 times the projector will turn off. Afterwards the projector will turn off every time an incorrect PIN Code is input. The projector will also turn off if there is no key input for about 5 minutes while the PIN BOX is displayed. This function will activate only when the projector is started after the power switch was turned off.</p> <ul style="list-style-type: none"> • Please do not forget your PIN Code. <p>3.2 Turning Off the PIN LOCK Function</p> <p>3.2-1 Follow the procedure in 3.1-1 to display the PIN LOCK on/off menu. Use the ▲/▼ buttons to select TURN OFF and the PIN BOX will be displayed. Enter the registered PIN Code to turn the PIN LOCK function off. If an incorrect PASSWORD is entered the menu will close.</p> <p>3.3 If you have forgotten your PIN Code</p> <p>3.3-1 While the PIN BOX is displayed, press and hold the RESET button for three seconds or press and hold the INPUT and ► buttons for three seconds. The 10 digit Inquiring Code will be displayed.</p> <p>NOTE: If there is no key input for about 5 minutes while the Inquiring Code is displayed the projector will turn off.</p> <p>3.3-2 Contact your dealer with the 10 digit Inquiring Code. Your PASSWORD will be sent after your user registration information is confirmed.</p> |

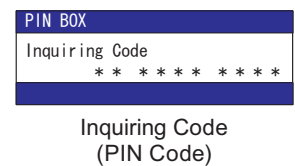
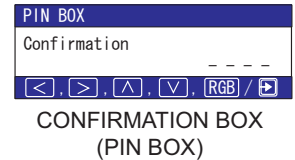
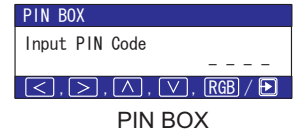

(continued on next page)

OPTION Menu (continued)

| Item | Description |
|------------------------|--|
| <p>SECURITY</p> | <p>4. Using the Transition Detector Function</p> <p>While the Transition Detector function is ON, when power switch is started to supply to the projector, it might react as below.</p> <ul style="list-style-type: none"> • Transition Detector alarm shown below might appear on screen, if the projector has been moved or re-installed. • Transition Detector alarm might appear on screen, if the MIRROR setting has been changed. • Keystone adjustment feature has been prohibited as long as the Transition Detector function is ON. <p>4.1 Turning On the Transition Detector Function</p> <p>4.1-1 Use the ▲/▼ buttons on the SECURITY menu to select Transition Detector and press the ► or the ENTER button to display the Transition Detector on/off menu. Select TURN ON and the current angle and mirror setting will be recorded.</p> <p>NOTE: This feature may not function properly if the projector is not in a stable position when TURN ON is selected.</p> <p>4.1-2 If this function is set to TURN ON when the vertical angle of the projector or mirror setting at which the projector is turned on is different than the previously recorded the Transition Detector Alarm will be displayed and the projector will not display the input signal.</p> <p>If the Transition Detector ALARM is displayed for about 5 minutes the lamp will turn off. This function will activate only when the projector is started after the power switch was turned off.</p> <p>4.2 Setting the Transition Detector PASSWORD</p> <p>4.2-1 Use the ▲/▼ buttons on the SECURITY menu to select Transition Detector and press the ► or the ENTER button to display the Transition Detector on/off menu.</p> <p>4.2-2 Use the ▲/▼ buttons on the Transition Detector on/off menu to select TURN ON. The ENTER PASSWORD BOX (small) will be displayed.</p> <p>4.2-3 Use the ▲/▼/◀/▶ buttons to enter a PASSWORD. Move the cursor to the right side of the ENTER PASSWORD BOX (small) and press the ► button to display the CHECK PASSWORD BOX, enter the same PASSWORD again.</p> <p>4.2-4 Move the cursor to the right side of the CHECK PASSWORD BOX and press the ► button to display the PASSWORD for about 20 seconds, please make note of the PASSWORD during this time.</p> <p>Pressing the ENTER button on the remote control or the INPUT button on the projector will return to the Transition Detector on/off menu.</p> <ul style="list-style-type: none"> • Please do not forget your Transition Detector PASSWORD. |

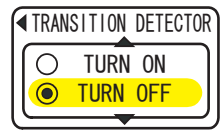

Transition Detector on/off menu

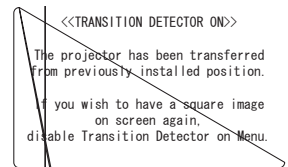

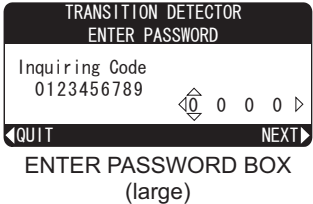

Transition Detector Alarm

OPTION Menu (continued)

| Item | Description |
|------------------------|--|
| <p>SECURITY</p> | <p>4.3 Setting the Transition Detector off</p> <p>4.3-1 Follow the procedure in 4.1-1 to display the Transition Detector on/off menu.</p> <p>4.3-2 Select TURN OFF to display the ENTER PASSWORD BOX (large). Enter the registered PASSWORD and the screen will return to the Transition Detector on/off menu. If an incorrect PASSWORD is input the menu will close. If necessary repeat the process from 4.3-1.</p> <p>4.4 If you have forgotten your PASSWORD</p> <p>4.4-1 Follow the procedure in 4.1-1 to display the Transition Detector on/off menu.</p> <p>4.4-2 Select TURN OFF to display the ENTER PASSWORD BOX (large). The 10 digit Inquiring Code will be displayed inside the BOX.</p> <p>4.4-3 Contact your dealer with the 10 digit Inquiring Code. Your PASSWORD will be sent after your user registration information is confirmed.</p> |
| |  |

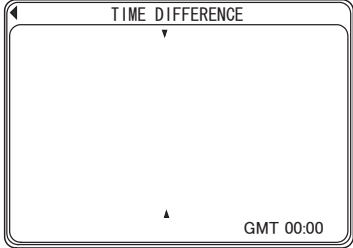
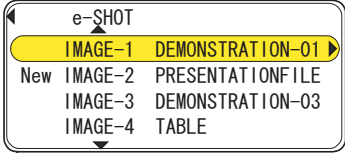

NETWORK Menu (continued)

| Item | Description |
|-------------------------------|--|
| <p>TIME DIFFERENCE</p> | <p>Entering the TIME DIFFERENCE : Use the ▲/▼ buttons to enter the TIME DIFFERENCE. Set the same TIME DIFFERENCE as the one set on your PC. If unsure, consult your network administrator. Use the ◀ button to return to the menu after setting the TIME DIFFERENCE.</p>  |
| <p>DATE AND TIME</p> | <p>Entering DATE AND TIME : Use the ▲/▼/◀/▶ buttons to enter the Year (last two digits), Month, Date, Hour and Minute.</p> <ul style="list-style-type: none"> The projector will override this setting and retrieve DATE AND TIME information from the Timeserver when SNTP is enabled. See [Date/Time Settings] in [User's Manual - Network Functions. 7cbÜ[i f]b[and Controlling the Projector via a Web Browser] for SNTP settings. |
| <p>e-SHOT</p> | <p>e-SHOT display : Use the ▲/▼ buttons to select an item and the ▶ or ENTER buttons to display the image.</p> <p>Image1 Image2 Image3 Image4</p>  <p>File names of registered images are displayed by 16 characters or less. Example: DEMONSTRATION-01 "NEW" stamp is added to the head of line when the image is registered newly. After the image is displayed, "NEW" stamp will be erased.</p> <p>Once an image is displayed, you can use the ▲/▼ buttons to page through the images. Use the ◀ or ESC buttons to return to the menu.</p> <p>Pressing the RESET button or the ▶ button for about 3 seconds while an image is being displayed will display the RESET menu. The displayed image can be deleted from the RESET menu using the ENTER button on the remote control or the INPUT button on the projector.</p> <p>If you do not wish to delete the image use the ESC button on the remote control or push the ◀ and INPUT buttons on the projector at the same time.</p> <ul style="list-style-type: none"> Items with no image stored cannot be selected. Images can be changed using the ▲/▼ buttons while the image data downloads.   |

(continued on next page)

NETWORK Menu (continued)

| Item | Description |
|---------------------------|--|
| <p>INFORMATION</p> | <p>INFORMATION display : Use the ► or ENTER buttons to view network information and confirm settings.</p> <div data-bbox="1102 353 1453 562" style="border: 1px solid black; padding: 5px;"> <p>◀ NETWORK-INFORMATION</p> <p>NAME</p> <p>IP ADDRESS 192.1.254</p> <p>SUBNETMASK 255.255.255.0</p> <p>DEFAULT GATEWAY 0.0.0.0</p> <p>MAC ADDRESS 00:00:87:56:AC:7C</p> <p>TIME DIFFERENCE GMT +00:00</p> <p>DATE AND TIME 2000/1/1 8:15</p> </div> <ul style="list-style-type: none"> • Only the first 16 characters of the projector name are displayed. • The battery for the built in clock may be dead if the clock loses time even when the DATE AND TIME have been set correctly. Replace the battery by following the instructions on replacing the battery. (📖60) |
| <p>SERVICE</p> | <p>Choose the RESTART using the ► button.</p> <div data-bbox="772 846 1023 947" style="border: 1px solid black; padding: 5px; text-align: center;"> <p>◀ SERVICE</p> <p>RESTART ►</p> </div> <p>Then use the ▲ button to execute.</p> <div data-bbox="772 1032 1023 1193" style="border: 1px solid black; padding: 5px; text-align: center;"> <p>◀ RESTART</p> <p>▲ EXECUTE</p> <p>▼ CANCEL</p> </div> <p>Network will be once cut off when choose restart. If DHCP is selected on, IP address may be changed. After selecting RESTART, Network menu may not be controlled approx. 20 seconds.</p> |

Network functions

Refer to the separate volume on Network Functions.

Lamp (continued)**⚠ WARNING**

HIGH VOLTAGE



HIGH TEMPERATURE



HIGH PRESSURE

► The projector uses a high-pressure mercury glass lamp. The lamp can break with a loud bang, or burn out, if jolted or scratched, handled while hot, or worn over time. Note that each lamp has a different lifetime, and some may burst or burn out soon after you start using them. In addition, when the bulb bursts, it is possible for shards of glass to fly into the lamp housing, and for gas containing mercury to escape from the projector's vent holes.

► **About disposal of a lamp** • This product contains a mercury lamp; do not put it in a trash. Dispose of it in accordance with environmental laws. For lamp recycling, go to www.lamprecycle.org. (in the US) For product disposal, contact your local government agency or www.eiae.org (in the US) or www.epsc.ca (in Canada). For more information, call your dealer.



Disconnect the plug from the power outlet

- If the lamp should break (it will make a loud bang when it does), unplug the power cord from the outlet, and make sure to request a replacement lamp from your local dealer. Note that shards of glass could damage the inside of the projector, or cause injury during handling, so please do not try to clean the projector or replace the lamp yourself.

- If the lamp should break (it will make a loud bang when it does), ventilate the room well, and make sure not to breathe the gas that comes out of the projector vents, or get it in your eyes or mouth.

- Before replacing the lamp, turn the projector off and unplug the power cord, then wait at least 45 minutes for the lamp to cool sufficiently. Handling the lamp while hot can cause burns, as well as damaging the lamp.



- Never unscrew except the appointed (marked by an arrow) screws.
- Do not open the lamp cover while the projector is suspended from the ceiling. This is dangerous, since if the lamp's bulb has broken, the shards will fall out when the cover is opened. In addition, working in high places is dangerous, so ask your local dealer to have the lamp replaced even if the bulb is not broken.

- Do not use the projector with the lamp cover removed. To replace the lamp, make sure that the screws are tightened firmly. Loose screws could result in damage or injury.



- Use only the lamp of the specified type.
- If the lamp breaks soon after the first time it is used, it is possible that there are electrical problems elsewhere besides the lamp. If this happens, contact your local dealer or a service representative.

- Handle with care: jolting or scratching could cause the lamp bulb to burst during use.
- Using the lamp for long periods of time, could cause it dark, not to light up or to burst. When the pictures appear dark, or when the color tone is poor, please replace the lamp as soon as possible. Do not use old (used) lamps; this is a cause of breakage.

Air filter

Please check and clean the air filter periodically. If the air filter becomes clogged by dust or the like, internal temperatures rise, which could cause a fire, a burn or malfunction to the projector. When the indicators or a message prompts you to clean the air filter, comply with it as soon as possible. Note that the projector may shut down, when the projector heats too much.

Please replace the air filter when it is damaged or too soiled. Preparation of a new air filter is recommended. To prepare a new air filter, contact with your dealer and tell the air filter type number.

Type number = MU03642

Cleaning the air filter

1. Turn the projector off, and unplug the power cord. Allow the projector to sufficiently cool down.
2. Use a vacuum cleaner on and around the filter cover.
3. Hold the filter cover knobs while lifting it. The filter unit made up the filter cover and others will come off.
4. Use a vacuum cleaner for the filter vent of the projector and the filter frame side of the filter unit.
If the air filter is damaged or too soiled, replace it according to the following procedure number 5 to 7. Otherwise, please jump to the procedure number 8.
5. To remove the filter frame, hold the filter cover while holding and pulling the filter frame's knob by another hand.
6. Replace the air filter with new one. It is recommended that the fluted surface of the air filter faces the filter cover.
7. Put the filter frame back.
8. Put the filter unit back into the projector.

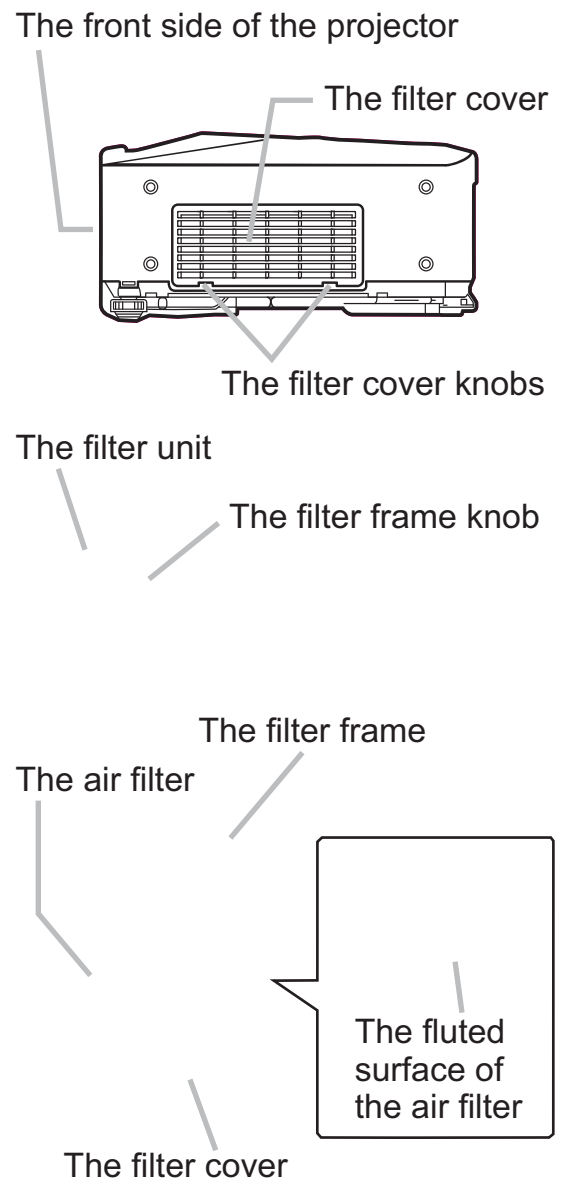

(continued on next page)

Air filter (continued)

9. Turn the projector on and reset the filter time using the FILTER TIME item in the EASY MENU (📖25).
- (1) Press the MENU button to display a menu.
 - (2) Point at the “FILTER TIME” using the ▼/▲ button, then press the ► button. A dialog will appear.
 - (3) Press the ▲ button to select “RESET” on the dialog. It performs resetting the filter time.

⚠WARNING ► Before taking care of the air filter, make sure the power switch is off and the power cable is not plugged in, then allow the projector to cool sufficiently. Taking care of the air filter in a high temperature state of the projector could cause an electric shock, a burn or malfunction to the projector.

► Use only the air filter of the specified type. Do not use the projector without the air filter or the filter cover. It could result in a fire or malfunction to the projector.

► Clean the air filter periodically. If the air filter becomes clogged by dust or the like, internal temperatures rise and could cause a fire, a burn or malfunction to the projector.

NOTE • Please replace the air filter when it is damaged or too soiled, and also when you replace the lamp.

• When you replace the projection lamp, please replace the air filter. An air filter of specified type will come together with a replacement lamp for this projector.

• Please reset the filter time only when you have cleaned or replaced the air filter, for a suitable indication about the air filter.

• The projector may display the message such as “CHECK THE AIR FLOW” or turn off the projector, to prevent the internal heat level rising.

Internal clock battery

Consumption of the battery makes the clock not to work correctly. When the clock is wrong or it has stopped, please replace the battery according to the following procedures.

1. Turn the projector off, and unplug the power cord. Allow the projector to cool sufficiently.
2. After making sure that the projector has cooled adequately, slowly turn over the projector, so that the bottom is facing.
3. Remove the battery cover. Turn the battery cover in the direction indicated "OPEN" using such as coins. Then the battery cover will come up. While removing the battery cover, pick its knob.
4. Take the old battery out. Press the metal claw of the battery holder. Then the battery will come up. Remove the battery.
5. Put a new battery in. **Replace battery with HITACHI MAXELL, Part No. CR2032**
 Insert a new battery in the battery holder according to its minus terminal \ominus as indicated in the battery holder, so that the side marked by + is facing. And push the battery into the battery holder fully to fix.
6. Close the battery cover. Replace the battery cover in place, then turn it in the direction indicated "CLOSE" using such as coins, to fix.

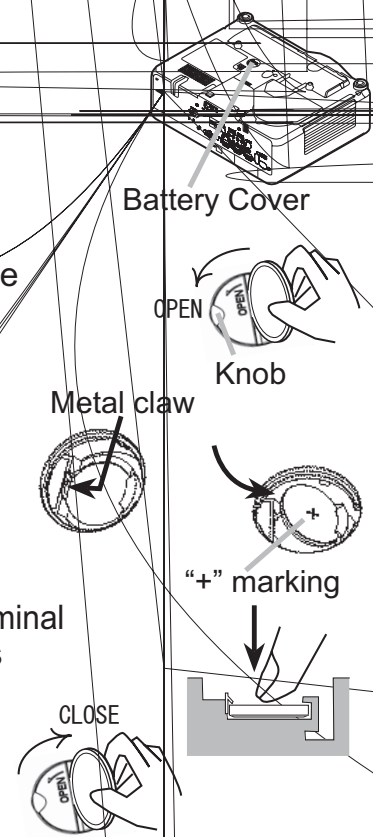

⚠ WARNING ▶ Always handle the batteries with care and use them only as directed. Battery may explode if mistreated. Do not recharge, disassemble or dispose of in fire. And also improper use may result in cracking or leakage, which could result in fire, injury and/or pollution of the surrounding environment.

- Be sure to use only the batteries specified. Do not use batteries of different types at the same time. Do not mix a new battery with used one.
- Make sure the plus and minus terminals are correctly aligned when loading a battery. If the battery is placed in the battery holder upside-down, it may be hard to remove.
- Keep a battery away from children and pets. If swallowed consult a physician immediately for emergency treatment.
- Do not short circuit or solder a battery.
- Do not allow a battery in a fire or water. Keep batteries in a dark, cool and dry place.
- If you observe a leakage of a battery, wipe out the flower and then replace a battery. If the liquid adheres to your body or clothes, rinse well with water immediately.
- Obey the local laws on disposing the battery.

NOTE • If the battery is placed in the battery holder upside-down, follow the procedure below to remove and reload it properly.

1. Remove the battery cover as described in steps 1 through 3 above.
2. Turn the projector over again, so that the top of the projector is facing up.
3. While lifting the side of the projector closest to the lens, press the metal claw of the battery holder. The battery will fall out of the holder, so be careful not to lose it.
4. Turn the projector over once more, so that the bottom faces up, and reload the battery correctly.
 - The internal clock's time will be reset when the battery is removed. Please reconfigure the time via the menu or a web browser after replacing the battery. (Please refer to [55](#) and User's Manual-Network Functions: Date/Time Settings for more information.)

Other care

Inside of the projector

In order to ensure the safe use of your projector, please have it cleaned and inspected by your dealer about once every year.

Caring for the lens

If the lens is flawed, soiled or fogged, it could cause deterioration of display quality. Please take care of the lens, being cautious of handling.

1. Turn the projector off, and unplug the power cord. Allow the projector to cool sufficiently.
2. After making sure that the projector is cool adequately, lightly wipe the lens with a commercially available lens-cleaning wipe. Do not touch the lens directly with your hand.

Caring for the cabinet and remote control

Incorrect care could have adverse influence such as discoloration, peeling paint, etc.

1. Turn the projector off, and unplug the power cord. Allow the projector to cool sufficiently.
2. After making sure that the projector is cool adequately, lightly wipe with gauze or a soft cloth.

If the projector is extremely dirty, dip soft cloth in water or a neutral cleaner diluted in water, and wipe lightly after wringing well. Then, wipe lightly with a soft, dry cloth.

⚠WARNING ▶ Before caring, make sure the power switch is off and the power cable is not plugged in, and then allow the projector to cool sufficiently. The care in a high temperature state of the projector could cause a burn and/or malfunction to the projector.

▶ Never try to care for the inside of the projector personally. Doing is so dangerous.

▶ Avoid wetting the projector or inserting liquids in the projector. It could result in a fire, an electric shock, and/or malfunction to the projector.

- Do not put anything containing water, cleaners or chemicals near the projector.

- Do not use aerosols or sprays.

⚠CAUTION ▶ Please take right care of the projector according to the following. Incorrect care could cause not only an injury but adverse influence such as discoloration, peeling paint, etc.

- ▶ Do not use cleaners or chemicals other than those specified in this manual.
- ▶ Do not polish or wipe with hard objects.

Troubleshooting

Related messages

When the unit's power is on, messages such as those shown below may be displayed. When any such message is displayed on the screen, please follow the instructions described below. If the same message is displayed after the remedy, or if a message other than the following appears, please contact your dealer or service company.

Although these messages will be automatically disappeared around several minutes, it will be reappeared every time the power is turned on.

| Message | Description |
|---|---|
| <p>NO INPUT IS DETECTED ***</p> | <p>There is no input signal. Please confirm the signal input connection, and the status of the signal source.</p> |
| <p>SYNC IS OUT OF RANGE *** [fH] **kHz [fV] **Hz</p> | <p>The horizontal or vertical frequency of the input signal]g`bch`k]h\]b`h\Y`gdYW]ÜYX`fUb [Y" Please confirm the specs for your projector or the signal source specs.</p> |
| <p>CHECK THE AIR FLOW</p> | <p>The internal temperature is rising. Please turn the power off, and allow the projector to cool down at least 20 minutes. After having confirmed the following items, please turn the power ON again.</p> <ul style="list-style-type: none"> • Is there blockage of the air passage aperture? • Is the air filter dirty? • Does the peripheral temperature exceed 35°C? <p>If the same indication is displayed after the remedy, please set FAN SPEED of the SERVICE item in the OPTION menu to HIGH.</p> |
| <p>REMINDER *** HRS PASSED AFTER THE LAST FILTER CHECK. FILTER MAINTENANCE IS ESSENTIAL TO REMOVE WARNING MESSAGE, RESET FILTER TIMER. SEE MANUAL FURTHER INFO.</p> | <p>5`bchY`cZ`dfYWU i h]cb`k \Yb`W`YUb]b [`h\Y`U]f`Ü`hYf" Please immediately turn the power off, and clean or change the air filter referring to the "Air Filter" section of this manual (📖58). After you have cleaned or changed the air filter, please be sure to reset the filter timer (📖43).</p> |

Regarding the indicator lamps

Lighting and flashing of the POWER indicator, the LAMP indicator, and the TEMP indicator have the meanings as described in the table below. Please follow the instructions within the table. If the same indication is displayed after the remedy, or if an indication other than the following is displayed, please contact your dealer or service company.

| POWER indicator | LAMP indicator | TEMP indicator | Description |
|---|----------------------------------|----------------------|---|
| Lighting In Orange | Turned off | Turned off | The projector is in a standby state. Please refer to the section "Power On/Off". |
| <i>Blinking</i> In Green | Turned off | Turned off | The projector is warming up. Please wait. |
| Lighting In Green | Turned off | Turned off | The projector is in an on state. Ordinary operations may be performed. |
| <i>Blinking</i> In Orange | Turned off | Turned off | The projector is cooling down. Please wait. |
| <i>Blinking</i> In Red | (discre- tionary) | (discre- tionary) | The projector is cooling down. A certain error has been detected. Please wait until the POWER indicator finishes blinking, and then perform the proper measure using the item descriptions below. |
| <i>Blinking</i> In Red or Lighting In Red | Lighting In Red | Turned off | The lamp does not light, and there is a possibility that interior portion has become heated. Please turn the power off, and allow the projector to cool down at least 20 minutes. After the projector has sufficiently cooled down, please make confirmation of the following items, and then turn the power on again. • Is there blockage of the air passage aperture? • Is the air filter dirty? • Does the peripheral temperature exceed 35°C? If the same indication is displayed after the remedy, please change the lamp referring to the section "Lamp". |
| <i>Blinking</i> In Red or Lighting In Red | <i>Blinking</i> In Red | Turned off | H\Y`U a d`Wc jYf` \Ug`bch`VYYb`dfcdYf`m`ÙIYX" Please turn the power off, and allow the projector to cool down at least 45 minutes. After the projector has sufficiently cooled down, please make confirmation of the attachment state of the lamp cover. After performing any needed maintenance, turn the power on again. If the same indication is displayed after the remedy, please contact your dealer or service company. |

Regarding the indicator lamps (continued)

| POWER indicator | LAMP indicator | TEMP indicator | Description |
|--|-------------------------------------|------------------------|--|
| Blinking In Red or Lighting In Red | Turned off | Blinking In Red | The cooling fan is not operating. Please turn the power off, and allow the projector to cool down at least 20 minutes. After the projector has sufficiently cooled down, please make confirmation that no foreign matter has become caught in the fan, etc., and then turn the power on again. If the same indication is displayed after the remedy, please contact your dealer or service company. |
| Blinking In Red or Lighting In Red | Turned off | Lighting In Red | There is a possibility that the interior portion has become heated. Please turn the power off, and allow the projector to cool down at least 20 minutes. After the projector has sufficiently cooled down, please make confirmation of the following items, and then turn the power on again. <ul style="list-style-type: none"> • Is there blockage of the air passage aperture? • Is the air filter dirty? • Does the peripheral temperature exceed 35°C? If the same indication is displayed after the remedy, please set FAN SPEED of the SERVICE item in the OPTION menu to HIGH. |
| Lighting In Green | Simultaneous blinking in Red | | There is a possibility that the interior portion has become overheated. Please immediately turn the power off, and clean or change the air filter referring to the section "Air Filter". After cleaning or changing the air filter, please be sure to reset the filter timer. After the remedy, reset the power to ON. |
| Lighting In Green | Alternative blinking in Red | | There is a possibility that the interior portion has become overcooled. Please use the unit within the usage temperature parameters (5°C to 35°C). After the treatment, reset the power to ON. |
| Blinking in Green for approx. 3 seconds | Turned off | Turned off | There is a possibility that the interior portion has become overcooled. (Please refer to the User's Manual-Network Functions: Schedule Settings for more information.) |

NOTE • When the interior portion has become overheated, for safety purposes, the power source is automatically turned off, and the indicator lamps may also be turned off. In such a case, press the "O" (OFF) side of the power switch, and wait at least 45 minutes. After the projector has sufficiently cooled down, please make confirmation of the attachment state of the lamp and lamp cover, and then turn the power on again.

Phenomena that may be easy to be mistaken for machine defects

⚠ WARNING ▶ Never use the projector if abnormal operations such as smoke, strange odor, excessive sound, damaged casing or elements or cables, penetration of liquids or foreign matter, etc. should occur. In such cases, immediately turn off the power switch and then disconnect the power plug from the power outlet. After making sure that the smoke or odor has stopped, contact your dealer or service company.

1. Before requesting repair, please check in accordance with the following chart. This operation sometimes resolves your problem.

If the situation cannot be corrected,

2. The projector's microprocessor may need to be reset. Please push the Shutdown switch by using a pin or similar and the projector will be turned off immediately.

Before turning it again, wait at least 10 minutes to make the projector cool down enough.

3. Some setting may be wrong. Please use the FACTORY RESET function of the SERVICE item in the OPTION menu (📖46) to reset all settings to factory default. Then, if the problem is not removed after the remedy, please contact your dealer or service company.

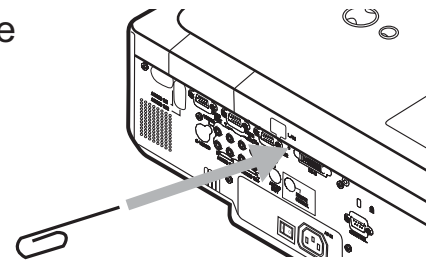

| Phenomenon | Cases not involving a machine defect | Reference page |
|--|---|----------------|
| Power does not come on. | The electrical power cord is not plugged in. Correctly connect the power cord. | 12 |
| | The power switch is not set to the on position. Set the power switch to [] (On). | 16 |
| | The main power source has been interrupted during operation such as by a power outage (blackout), etc. Please turn the power off, and allow the projector to cool down at least 2 minutes, then turn the power on again. | 16 |
| | Either there is no lamp and/or lamp cover, or either cZ'h\YgY' \Ug'bch'VYYb'dfcdYf'm'ÜIYX" Please turn the power off, and allow the projector to cool down at least 45 minutes. After the projector has sufficiently cooled down, please make confirmation of the attachment state of the lamp and lamp cover, and then turn the power on again. | 56 |
| Neither sounds nor pictures are outputted. | The signal cables are not correctly connected. Correctly connect the connection cables. | 10 |
| | Signal source does not correctly work. Correctly set up the signal source device by referring to the manual of the source device. | — |
| | The input changeover settings are mismatched. Select the input signal, and correct the settings. | 17, 18 |

Phenomena that may be easy to be mistaken for machine defects (continued)

| Phenomenon | Cases not involving a machine defect | Reference page |
|---|--|----------------|
| Sound does not come out. | The signal cables are not correctly connected. Correctly connect the audio cables. | 10 |
| | The MUTE function is working. Restore the sound pressing the MUTE or VOLUME button on the remote control. | 17 |
| | The volume is adjusted to an extremely low level. Adjust the volume to a higher level using the menu function or the remote control. | 17 |
| | The AUDIO setting is not correct. Correctly set the items in the AUDIO menu. | 37 |
| No pictures are displayed. | The lens cap is attached. Remove the lens cover. | 4, 16 |
| | The signal cables are not correctly connected. Correctly connect the connection cables. | 10 |
| | The brightness is adjusted to an extremely low level. Adjust BRIGHTNESS to a higher level using the menu function or the remote control. | 24, 26 |
| | The computer cannot detect the projector as a plug and play monitor. Make sure that the computer can detect a plug and play monitor using another plug and play monitor. | 11 |
| | The BLANK screen is displayed. Press the BLANK button on the remote control. | 22 |
| Video screen display freezes. | The FREEZE function is working. Press the FREEZE button to restore the screen to normal. | 21 |
| Colors have a faded- out appearance, or Color tone is poor. | Color settings are not correctly adjusted. Perform picture adjustments by changing the COLOR TEMP, COLOR, TINT and/or COLOR SPACE settings, using the menu functions. | 25, 27, 31 |
| | COLOR SPACE setting is not suitable. Change the COLOR SPACE setting to AUTO, RGB, SMPTE240, REC709 or REC601. | 31 |

Phenomena that may be easy to be mistaken for machine defects (continued)

| Phenomenon | Cases not involving a machine defect | Reference page |
|-------------------------|--|----------------|
| Pictures appear dark. | <p>The brightness and/or contrast are adjusted to an extremely low level. Adjust BRIGHTNESS and/or CONTRAST settings to a higher level using the menu function.</p> | 24, 25, 26 |
| | <p>The WHISPER function is working. Select NORMAL for the WHISPER item in the SETUP menu.</p> | 25, 36 |
| | <p>The lamp is approaching the end of its product lifetime. Replace the lamp.</p> | 56, 57 |
| Pictures appear blurry. | <p>Either the focus and/or horizontal phase settings are not properly adjusted. Adjust the focus using the focus ring, and/or H PHASE using the menu function.</p> | 19, 30 |
| | <p>The lens is dirty or misty. Clean the lens referring to the section “Caring for the lens”.</p> | 61 |
| Pictures are trembling. | <p>The exhaust ventilation holes at front is blocked by some objects. Remove any objects from front side of the projector.</p> | 4 |

NOTE • Although bright spots or dark spots may appear on the screen, this is a unique characteristic of liquid crystal displays, and it does not constitute or imply a machine defect.

Warranty and after-service

If a problem occurs with the equipment, first refer to the “Troubleshooting” and run through the suggested checks. If this does not resolve the problem, please contact your dealer or service company. They will tell you what warranty condition is applied.

Specification

| Item | GdYWJÙWUh]cb | |
|----------------------|---|--|
| Product name | Liquid crystal projector | |
| Liquid Crystal Panel | Panel size | 2.0 cm (0.79 type) |
| | Drive system | TFT active matrix |
| | Pixels | 786,432 pixels (1024 horizontal x 768 vertical) |
| Lens | Zoom lens F=1.7 ~ 2.1 f=24 ~ 29 mm | |
| Lamp | 285W UHB | |
| Speaker | 4W x 4 | |
| Power supply | AC 100-120V/5.0A, AC220-240V/2.1A | |
| Power consumption | 460W | |
| Temperature range | 5 ~ 35°C (Operating) | |
| Size | 418 (W) x 139 (H) x 319 (D) mm (Not including protruding parts) * Please refer to the following figure. | |
| Weight (mass) | 7.1 kg | |
| Ports | RGB input port RGB1.....D-sub 15pin mini x1 RGB2.....D-sub 15pin mini x1 RGB output port RGB OUT..D-sub 15pin mini x1 Digital input port M1-D.....M1-D x1 Video input port Y, CB/PB, CR/PR RCA x3 S-VIDEOS-video x1 VIDEOVideo x1 | Audio input port AUDIO IN1Stereo mini x1 AUDIO IN2Stereo mini x1 AUDIO IN3 RCA x2 AUDIO IN4 RCA x2 Communication port CONTROL..... D-sub 9pin x1 Other ports NETWORK.....RJ45 x1 REMOTE CONTROLStereo mini x1 |
| Optional parts | Lamp | DT00771 |
| | Air filter | MU03642 |
| | Others | * Please consult your dealer. |

NOTE • These specifications are subject to change without notice.

Specifications (continued)

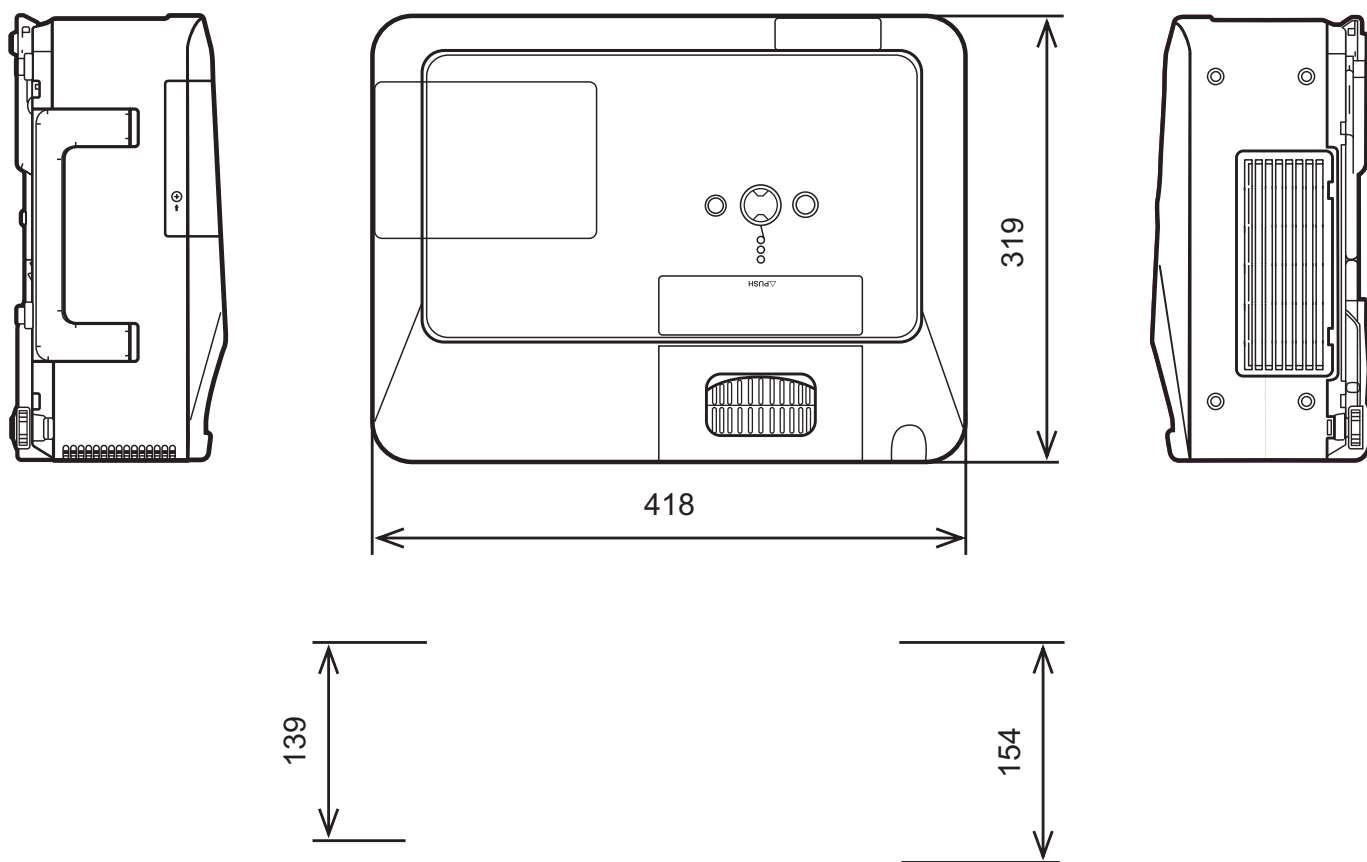

[unit: mm]