



OWNER'S INSTRUCTIONS

AW0500/AW0500A

AW0510/AW0510C/AW0510D

AW0510A/AW0510B

AW0600/AW0610A

WINDOW-TYPE ROOM AIR CONDITIONER (Cool)

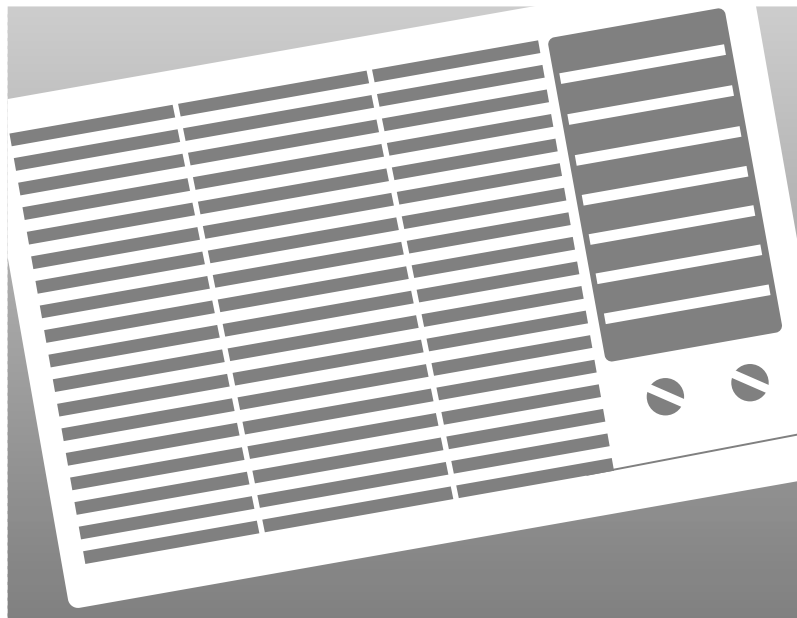

Safety Precautions

The following safety precautions must be taken when using your air conditioner.

- 1 *The unit must be plugged into an independent circuit.
The air conditioner must be installed in accordance with national wiring regulations and safety regulations wherever applicable.*
- 2 *Some installation locations may require installation of a short circuit breaker or grounding.*
- 3 *If the supply cord is damaged, it must be replaced by a special cord or assembly available from the manufacturer or its service agent.*
- 4 *MAKE sure that the unit is correctly ventilated at all times :
do NOT place clothing or other materials over it.*
- 5 *NEVER spill any kind of liquid into the unit. Should this happen, unplug the unit and contact an authorized service center.*
- 6 *Do NOT insert anything between the air outlet blades because the inner fan may be damaged and could cause injury. Keep children away from the unit.*
- 7 *Do NOT place any obstacles in front of the unit.*
- 8 *Users of this product are cautioned not to attempt repairs.
Instead, they are requested to directly contact a designated service center or the outlet at which the product was purchased.*
- 9 *Do not use an extension cord with this product.*
- 10 *The appliance is not intended for use by young children without supervision ;
young children should be supervised to ensure that they do not play with the appliance.*
- 11 *Because the rear of air conditioner is very sharp, please put gloves on when carrying or installing the air conditioner.*
- 12 *Never store or ship the air conditioner upside down or sideways to avoid damage to the compressor.*

CAUTION

The manufacturer does not assume responsibility for accidents or injury caused by an incorrectly installed air conditioner. If you are unsure about installation, contact an installation specialist.

Contents

- ◆ PREPARING YOUR AIR CONDITIONER
 - Safety Precautions 2
 - Description of Each Component 4
 - Getting Started 5

- ◆ OPERATING YOUR AIR CONDITIONER
 - Cooling Your Room 6
 - Ventilating Your Room 7
 - Adjusting the Air Flow Direction Horizontally 7

- ◆ RECOMMENDATIONS FOR USE
 - Power Failure 8
 - Temperature and Humidity Range 8
 - Cleaning Your Air Conditioner 9
 - Solving Common Problems 10
 - Technical Specifications 11

- ◆ INSTALLATION 12

Description of Each Component

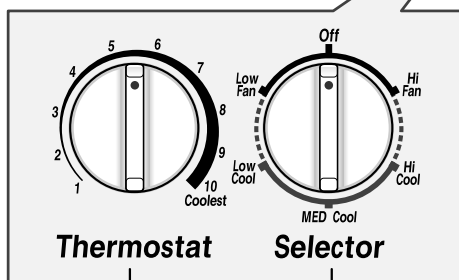
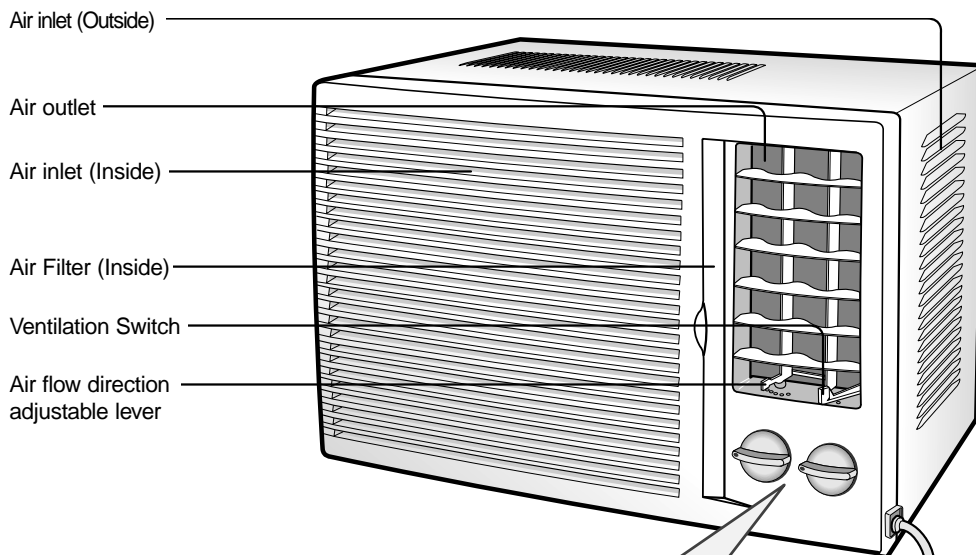

Power plug
(Be sure to check the voltage
before installation.)

Thermostat control

Selector

Getting Started

You have just purchased a Samsung window-type room air conditioner which should be installed following your Owner's Instructions.

Your Owner's Instructions contain much valuable information on using your air conditioner. Please take the time to read them as they will help you take full advantage of the unit's features.

Cooling Your Room

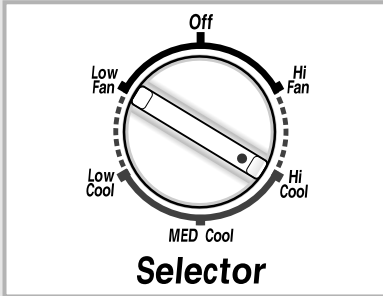

Selector

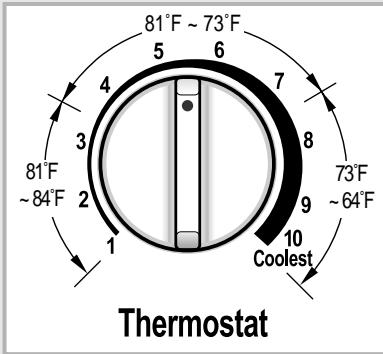

Thermostat

You must select the COOL mode if you wish to adjust the:

- ◆ *Cooling temperature*
- ◆ *Fan speed when Cooling*

-
- 1** Turn the SELECTOR and set it to “ HI COOL ”, “ MED COOL ” or “ LOW COOL ”.

Result: ◆ The air conditioner starts up in cool mode.

Note ◆ You can change modes at any time.

-
- 2** Turn the THERMOSTAT control to the desired position.

Possible temperatures: Can be set between 64°F and 84°F.

Result: The air conditioner starts cooling if the room temperature is higher than the selected temperature.

-
- 3** To control the direction of the air flow, refer to page 7.
-

Ventilating Your Room

If the air in your room is stale, you can ventilate the room using the Fan feature.

- 1 If you wish to discharge stale air, push the ventilation switch on the front of the unit to the right and open position().

Result: ♦ The air inside the room circulates and stale air is discharged outside.

Otherwise, push the ventilation switch to the left and closed position() .

Result: ♦ The air simply circulates inside the room.

- 2 Turn the SELECTOR and set it to “HI FAN” or “LOW FAN” position.

Result: ♦ The air conditioner starts up in fan mode.

Note ♦ HI FAN : The fan turns rapidly.
♦ LOW FAN : The fan turns slowly.
♦ You can change modes at any time.

- 3 To control the direction of the air flow, refer to the section below.

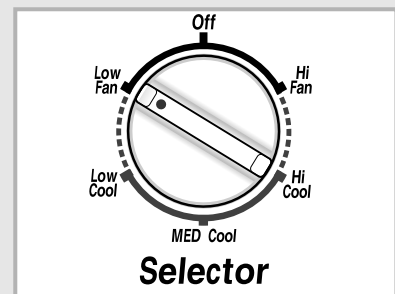
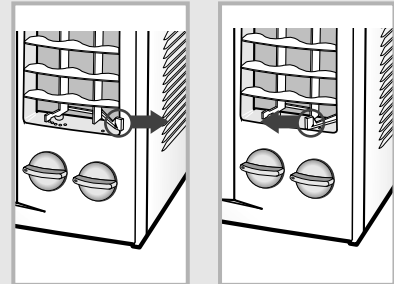

Adjusting the Air Flow Direction Horizontally

The air flow direction blades can be adjusted to improve the efficiency of the air conditioner.

- 1 The side by side air direction louvers are together and are controlled by a lever. They regulate air discharge to the right, left or straight.

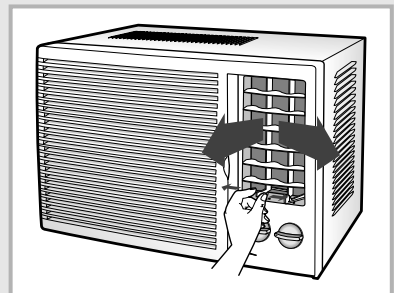

Power Failure

If a power failure occurs, set the SELECTOR to OFF. When the power comes back on, wait five minutes before turning the unit back on.

Temperature and Humidity Range

The following table indicates the temperature and humidity ranges within which the air conditioner can be used.

If the air conditioner is used at...	Then...
Higher temperature	The automatic protection feature may be triggered and the air conditioner stopped.
Lower temperature	A water leakage or some other malfunction may happen if the heat exchanger freezes.

Mode	Indoor Temperature	Outdoor Temperature	Indoor Humidity
Cooling	70°F to 90°F approx.	70°F to 110°F approx.	80% or less If the unit is used for long periods at a high humidity level, water may condense on and drip from the surface of the air conditioner.

Cleaning Your Air Conditioner

Be sure to clean the air filter periodically to maintain the air conditioner in the best condition for a long period of time.

IMPORTANT *When cleaning the air conditioner, turn it off and pull out the power plug.*

- 1 Hold the air filter handle, pull it slightly forward, and then pull it out to the right side.

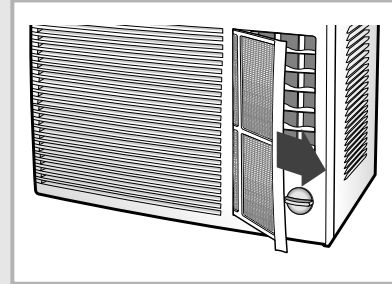

- 2 Remove the dust on the air filter using a vacuum cleaner and brush.

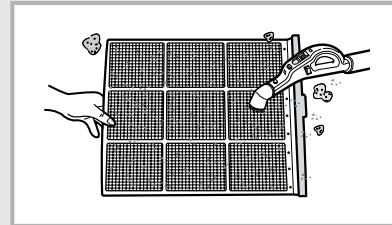

- 3 Insert the air filter back into its original position.

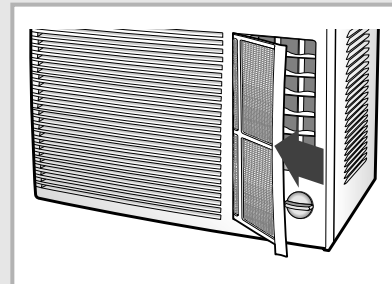

- 4 Wipe the surface of the unit with a neutral detergent and then wipe it again with dry cloth.
(Be sure not to use benzene, solvent or other chemical products.)

Note *Storing the unit for a long period of time.*

- ◆ Check the cleanliness of the air conditioner.
- ◆ Set the SELECTOR to "LOW FAN", and dry the inside of the air conditioner by operating it for 4 ~ 5 hours.
(The service life of the air conditioner is lengthened when the dew formed on the heat exchanger is removed before storage.)
- ◆ Turn off the air conditioner, and pull out the power plug.

Solving Common Problems

Before contacting an authorized service center, perform the following simple checks. They may save you the time and the expense of an unnecessary call.

Problem	Explanation / Solution
The air conditioner does not operate at all.	<ul style="list-style-type: none">◆ Check for a power failure.◆ Check the voltage. (See the technical specifications)◆ Check the power plug for disconnection.◆ Check to see whether the SELECTOR is placed in the "OFF" position. (Set it to the desired position.)◆ Check to see whether the room temperature is too low. - Refer to page 8 for details about temperature condition.
The air comes out smoothly, but cooling is not effective.	<ul style="list-style-type: none">◆ Set the THERMOSTAT control to the desired position. - When the number on the THERMOSTAT control is high, the room temperature may be too warm.◆ Check to see whether there is any open window or leakage of cool air to the outside. - Close the window, and fill the gap.◆ Check to see whether there is any obstacle adversely affecting the flow of the air inside and outside the room. - Remove the obstacle or change the position of the air conditioner.◆ Check to see whether the air filter is clogged with dust or contaminated with foreign substances. - Clean the air filter.◆ Check to see whether there is any direct sunlight facing the air conditioner. - Block the sunlight with a sunshade.◆ Check to see whether there is any electric device generating heat. - Do not use the air conditioner together with any heating device.

Technical Specifications

Model	Cooling Capacity(BTU/h)	Power Supply
AW0500	5000	
AW0500A	5000	
AW0510	5000	
AW0510C	5000	115V~, 60Hz
AW0510A	5000	
AW0510B	5000	
AW0600	6000	
AW0510D	5200	
AW0610A	6000	

Design and specifications are subject to change without notice.

Installation

Before installation, please read the INSTALLATION instructions, then follow the procedures in order after considering the installation area and drain hose.

CAUTION

- ◆ *The manufacturer does not assume responsibility for accident or injury caused by an incorrectly installed air conditioner. If you are unsure about installation, contact an installation specialist.*

Checkpoints prior to installation

- 1 Check the cabinet and front grille of the unit for any defects such as scratches.
- 2 Be sure to check the power supply.
 - Refer to the specifications on the label attached to the unit.

Installation instructions

1 Electrical Requirements

For personal safety:

- ◆ This appliance must be properly grounded.
- ◆ Do not, under any circumstances, cut or remove the third grounding prong from the power cord.
- ◆ We recommend that you do not use an extension cord or an adapter plug with this appliance.
- ◆ Do not change the plug on the power cord of this appliance.
- ◆ Follow national electrical codes or local codes and ordinances.

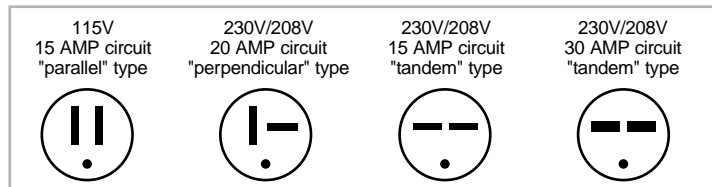

- ◆ If the electric supply provided does not meet the above specifications, call a licensed electrician.
- ◆ Aluminum house wiring may pose special problems - consult a qualified electrician.
- ◆ This unit requires a separate circuit, serving only this appliance.

2 Window Requirements

- ◆ Standard double-hung window with actual opening width of 22" to 36". The installation will need to be modified for windows other than the standard double-hung type.
- ◆ Clear vertical opening of 12 7/8" minimum, from bottom of sash to sill.
- ◆ Install the air conditioner in a window where there will be enough clearance around the cabinet to allow ample circulation of air through the unit.

Note All supporting parts should be secured to firm wood, masonry or metal.

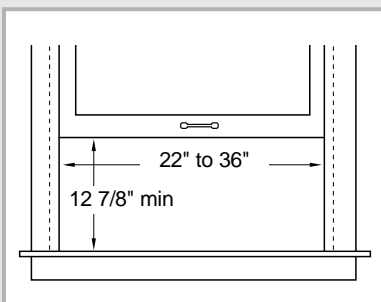





Window installation

Tools needed

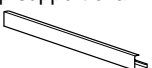
- ◆ Philips head screwdriver
- ◆ Adjustable wrench
- ◆ Scissors
- ◆ Ruler or tape measure
- ◆ Pencil

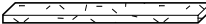
Parts furnished

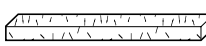
Type	Name of part	Q'ty	Type	Name of part	Q'ty	Type	Name of part	Q'ty
A	Long wood screw (5X16) 	7	D	Top support channel 	1	G	Window filler panel(Right) 	1
B	Screw (4X10) 	9	E	Adhesive seal strip 	1	H	Window filler panel(Left) 	1
C	Window bracket 	2	F	Window gasket 	1			

1 Install the top support channel with **three Type B screws** provided.

Note The screw holes are larger gauge on the channel and smaller on the cabinet.
The top support channel is "L" shaped. The high side of the channel must always face inwards.

2 Assemble the window brackets on the cabinet.

- 2-1 Loosen the lower screw slightly on each side of the cabinet and install the **Type C window bracket**.
- 2-2 Tighten the screws securing the brackets.

3 Attach the window filler panels to the unit.

- 3-1 Slide the window filler panels and their frames into the channels on the top and bottom of the cabinet.
- 3-2 Assemble the window filler panels to the cabinet using **six Type B screws**.

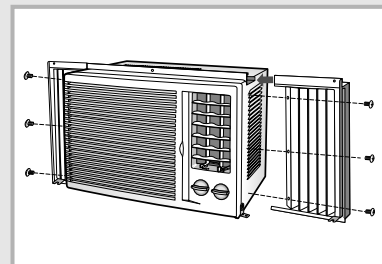
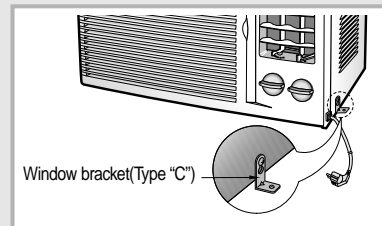
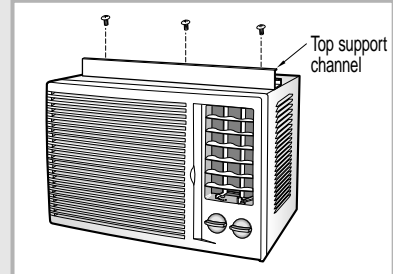

Installation (Cont.)

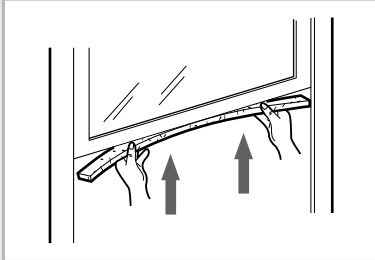

4 Attach the seal strip to the window.

- 4-1 Cut the adhesive-backed foam seal strip gasket to the window width.
- 4-2 Remove the backing from the seal strip and attach the strip to the underside of the bottom window.

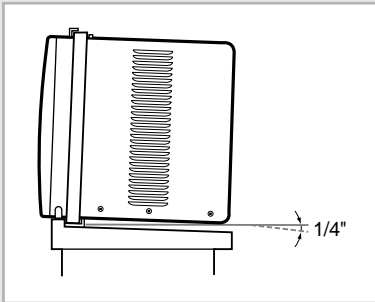

5 Install the unit in the window.

- 5-1 Place the air conditioner cabinet into the window with the top support channel positioned just in front of the bottom sash.
- 5-2 Center the cabinet, side to side in the window then pull the window down until it rests on the air conditioner, just behind the mounting channel front flange on top of the cabinet.
- 5-3 **Make sure the cabinet maintains a slightly downward slant to the outside. A 1/4" slant, cabinet front to rear is desirable to help prevent water from entering the room.**

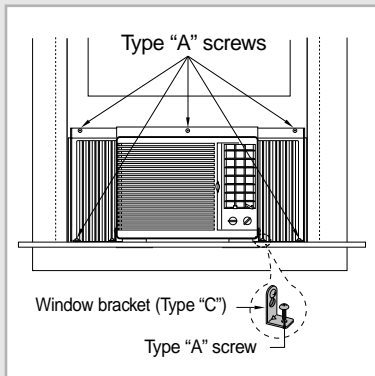

6 Extend the window filler panels.

- 6-1 Secure the window brackets to the stool using the **Type A screw** at each side.
- 6-2 Secure the top mounting channel to the bottom sash with the **Type A screw** in the center.
- 6-3 Extend the window filler panels into the window sash tracks on both sides. When the window is pulled down, the window should rest on the unit just behind the window filler panel frames.
- 6-4 Slide the window filler panels outward until they touch the sides of the window. Secure the panels by putting **four Type A screws** through the mounting holes in the panels and driving them into the window stool and sash.

-
- 7** Install the window gasket.
Cut the foam window gasket to the window width and stuff it between the window and the glass to prevent air and insects from getting into the room.

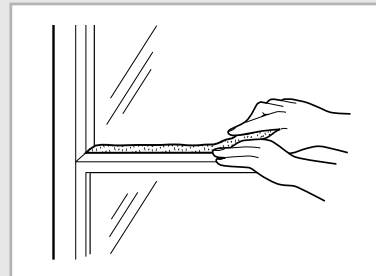

-
- 8** Check for air leaks and seal.

-
- 9** Plug in the power, switch on the air conditioner, turn the SELECTOR to COOL mode and check for unusual vibrations.

Note After several minutes the unit will be blowing out cold air.
If the unit is not cold, please return it to the dealer.

Installation (Cont.)

Removal of the Front Grille

If you need to remove the front grille for replacement, follow the steps below.

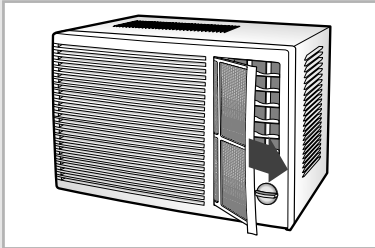

- 1 Hold the air filter handle, pull it slightly forward, and then pull it out to the right side.

Note Remove the shipping tape before pulling out the air filter, if necessary.

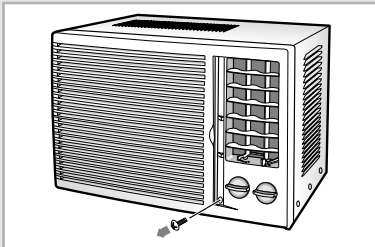

- 2 Remove the screw below the control panel that holds the grille in place.
 - ◆ Remove two knobs on the lower right hand section by pulling them forward.

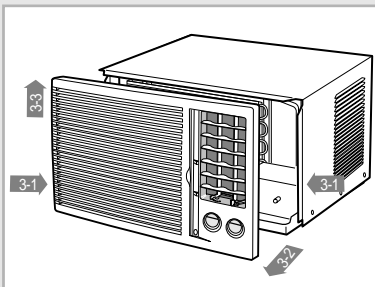

- 3 Disassemble the front grille.
 - 3-1 Press both sides of the cabinet in the direction of the arrow as shown in the figure.
 - 3-2 Pull the lower part of the front grille slightly forward.

Note Do not pull bottom edge of grille toward you more than 3". Damage to the grille's two top tabs may occur.

- 3-3 Grasp the grille at both sides near the bottom and carefully lift it straight up to disengage the grille's two top tabs from slots near the top of the cabinet.

- 4 Reinstall the front grille.
 - 4-1 Fix the upper front grille.
 - 4-2 Slide one side of the lower part of the front grille slightly backward.
 - 4-3 Slide the other side backward.
 - 4-4 Reinstall the screw, the air filter and the knobs.

SAMSUNG ROOM AIR CONDITIONER

LIMITED WARRANTY TO ORIGINAL PURCHASER

This SAMSUNG brand product, as supplied and distributed by SAMSUNG ELECTRONICS AMERICA, INC. (SAMSUNG) and delivered new, in the original carton to the original consumer purchaser, is warranted by SAMSUNG against manufacturing defects in materials and workmanship for a limited warranty period of:

One (1) Year Parts and Labor, Five (5) Years Parts Warranty for Compressor

This limited warranty begins on the original date of purchase, and is valid only on products purchased and used in the United States. Warranty repairs must be performed by SAMSUNG's authorized service center. To receive warranty service, the original dated bill of sale must be presented upon request as proof of purchase to SAMSUNG or SAMSUNG's authorized service center.

SAMSUNG will repair or replace any part found to be defective at no charge, as stipulated herein, with new or reconditioned parts during the limited warranty period specified above. To request warranty service, the purchaser must contact SAMSUNG for problem determination and service procedures. SAMSUNG does not warrant uninterrupted or error-free operation of the product. All replaced parts and products become the property of SAMSUNG and must be returned to SAMSUNG. Replacement parts and products assume the remaining original warranty, or ninety (90) days, whichever is longer.

This limited warranty covers manufacturing defects in materials and workmanship encountered in normal, noncommercial use of this product and shall not apply to the following, including, but not limited to: delivery and installation; damage which occurs in shipment; applications and uses for which this product was not intended; failures or problems which are caused by products or equipment not supplied by SAMSUNG; accidents, misuse, abuse, neglect, misapplication, fire, water, lightning or other acts of nature; incorrect electrical line voltage, fluctuations or surges; damage caused by improper or faulty installation; product alteration or modification; improper or unauthorized repair; cosmetic damage or exterior finish; product with altered serial numbers; failure to follow operating and environmental instructions that are covered and prescribed in the instruction book; customer adjustments, routine maintenance and cleaning; consumable items such as filters; use of non-SAMSUNG or unauthorized parts, supplies, accessories or equipment which damage this product or result in service problems.

THERE ARE NO EXPRESS WARRANTIES OTHER THAN THOSE LISTED AND DESCRIBED ABOVE, AND NO WARRANTIES WHETHER EXPRESS OR IMPLIED, INCLUDING, BUT NOT LIMITED TO, ANY IMPLIED WARRANTIES OF MERCHANTABILITY OR FITNESS FOR A PARTICULAR PURPOSE, SHALL APPLY AFTER THE EXPRESS WARRANTY PERIODS STATED ABOVE, AND NO OTHER EXPRESS WARRANTY OR GUARANTY GIVEN BY ANY PERSON, FIRM OR CORPORATION WITH RESPECT TO THIS PRODUCT SHALL BE BINDING ON SAMSUNG. SAMSUNG SHALL NOT BE LIABLE FOR LOSS OF REVENUE OR PROFITS, FAILURE TO REALIZE SAVINGS OR OTHER BENEFITS, OR ANY OTHER SPECIAL, INCIDENTAL OR CONSEQUENTIAL DAMAGES CAUSED BY THE USE, MISUSE OR INABILITY TO USE THIS PRODUCT, REGARDLESS OF THE LEGAL THEORY ON WHICH THE CLAIM IS BASED, AND EVEN IF SAMSUNG HAS BEEN ADVISED OF THE POSSIBILITY OF SUCH DAMAGES. NOR SHALL RECOVERY OF ANY KIND AGAINST SAMSUNG BE GREATER IN AMOUNT THAN THE PURCHASE PRICE OF THE PRODUCT SOLD BY SAMSUNG AND CAUSING THE ALLEGED DAMAGE. WITHOUT LIMITING THE FOREGOING, PURCHASER ASSUMES ALL RISK AND LIABILITY FOR LOSS, DAMAGE OR INJURY TO PURCHASER AND PURCHASERS PROPERTY AND TO OTHERS AND THEIR PROPERTY ARISING OUT OF THE USE, MISUSE OR INABILITY TO USE THIS PRODUCT SOLD BY SAMSUNG NOT CAUSED DIRECTLY BY THE NEGLIGENCE OF SAMSUNG. THIS LIMITED WARRANTY SHALL NOT EXTEND TO ANYONE OTHER THAN THE ORIGINAL PURCHASER OF THIS PRODUCT, IS NONTRANSFERABLE AND STATES YOUR EXCLUSIVE REMEDY.

Some states do not allow limitations on how long an implied warranty lasts, or the exclusion or limitation of incidental or consequential damages, so the above limitations or exclusions may not apply to you. This warranty gives you specific legal rights, and you may also have other rights which vary from state to state.

To obtain warranty service, please contact SAMSUNG at:

SAMSUNG ELECTRONICS AMERICA, INC. - CONSUMER ELECTRONICS CUSTOMER SERVICE
1 SAMSUNG PLACE, LEDGEWOOD, NJ 07852
Tel: 973-691-6200, Fax: 973-691-6201
1-800-SAMSUNG (1-800-726-7864)
www.sosimple.com