

FURUNO

OPERATOR'S MANUAL

MARINE RADAR

MODEL FR - 1430DS



FURUNO ELECTRIC CO., LTD.
NISHINOMIYA, JAPAN

©FURUNO ELECTRIC CO., LTD.

9-52, Ashihara-cho,
Nishinomiya, Japan 662

Telephone: 0798-65-2111
Telefax: 0798-65-4200

•Your Local Agent/Dealer

All rights reserved. Printed in Japan

FIRST EDITION : MAY 1992
C : MAY 20, 1997

(TATA)

PUB. No. OME-33700
FR-1430DS





SAFETY INSTRUCTIONS



DANGER



Do not open the equipment.

Hazardous voltage which will cause death or serious injury exists inside the equipment. Only qualified personnel should work inside the equipment.



WARNING

Do not expose any part of the body to the transmitting antenna at a close distance.

The radar antenna emits electromagnetic radio frequency (RF) energy which can be harmful, particularly to your eyes.



Turn off the radar power switch before servicing the antenna unit. Post a warning sign near the switch indicating it should not be turned on while the antenna unit is being serviced.

Prevent the potential risk of being struck by the rotating antenna and exposure to RF radiation hazard.



WARNING

Turn off the power immediately if water leaks into the equipment or the equipment is emitting smoke or fire.

Continued use of the equipment can cause fire or electrical shock.

Do not place liquid-filled containers on the top of the equipment.

Fire or electrical shock can result if a liquid spills into the equipment.

Do not operate the equipment with wet hands.

Electrical shock can result.

Keep heater away from equipment.

Heat can alter equipment shape and melt the power cord, which can cause fire or electrical shock.



CAUTION

Use the proper fuse.

Use of a wrong fuse can result in fire or permanent equipment damage.

Do not use the equipment for other than its intended purpose.

Personal injury can result if the equipment is used as a chair or stepping stool, for example.

Do not place objects on the top of the equipment.

The equipment can overheat or personal injury can result if the object falls.

Table of Contents

Introduction	v
--------------------	---

Specifications.....	vii
---------------------	-----

1 OPERATIONAL OVERVIEW

Basic Operation	1-3
Turning the power on	1-3
Transmitting the radar	1-3
Suspending transmission	1-3
Turning the power off	1-3
Selecting range	1-4
Adjusting the GAIN control	1-4
Adjusting the A/C SEA control	1-5
Adjusting the A/C RAIN control	1-6
Automatic clutter control	1-6
Adjusting CRT brilliance	1-7
Adjusting mark brilliance	1-7
Adjusting range ring brilliance	1-7
Erasing the heading mark/north mark	1-7
Selecting display colors	1-7
Selecting presentation mode	1-8
Measuring Range and Bearing	1-10
Overview	1-10
Displaying or erasing the fixed range rings	1-10
Displaying an EBL or VRM	1-10
Erasing an EBL or VRM	1-10
Displaying or erasing the cross-hair cursor	1-10
Measuring range	1-11
Measuring relative bearing	1-11
Measuring true bearing	1-12
Floating Origin EBL	1-13
Overview	1-13
Setting the Guard Alarm	1-14
Overview	1-14
Notes and cautions on alarm usage	1-16
Shifting the Display	1-17
Overview	1-17
Zoom	1-18
Overview	1-18
Echo Trailing	1-19
Overview	1-19
Operation by Menu	1-21
Overview	1-21
Menu layout	1-22
Selecting items on the menu	1-25
Echo stretch	1-25
Echo averaging	1-26
Radar interference	1-27

Noise interference	1-27
Pulsewidth	1-28
Second trace echo rejection	1-28
Echo trailing	1-29
Index line	1-30
Ship's speed input	1-30
Guard alarm type	1-31
Panel dimmer	1-31
Character brilliance	1-31
Heading mark brilliance	1-32
Stern mark on or off	1-32
EBL bearing	1-32
VRM unit	1-32
+ cursor	1-33
Echo color	1-33
Function Keys	1-35
Overview	1-35
Programming the function keys	1-36
Executing a program	1-36
Panel 3	1-37
Overview	1-37
Degaussing the picture	1-38
Adjustment of gyro reading (technicians only)	1-38
Tuning the receiver (technicians only)	1-38
Description of Controls	1-39
Markers and Indications	1-40

2

APPLICATION

Factors Affecting Minimum Range	2-2
Overview	2-2
Sea return	2-2
Vertical beamwidth	2-2
Factors Affecting Maximum Range	2-3
Overview	2-3
Radar horizon	2-3
Target properties	2-4
Interpreting the Display	2-5
Overview	2-5
Land targets	2-5
Ship targets	2-6
Echo size	2-6
False Echoes	2-7
Overview	2-7
Multiple echoes	2-7
Side-lobe echoes	2-7
Blind and shadow sectors	2-8
Indirect echoes	2-8
Radar Picture and Corresponding Chart	2-10
Position Fixing with Radar	2-11
Overview	2-11
By radar range	2-11
By range and bearing to a point of land	2-11
By two bearings	2-12
Collision Avoidance and Relative Motion	2-13
Assessing the risk	2-14

3	MAINTENANCE	
	Regular Maintenance	3-2
	Life Expectancy of Major Parts	3-3
4	TROUBLESHOOTING	
	Troubleshooting Table	4-2
5	LOCATION OF PARTS	
	Display Unit	5-2
	Scanner Unit	5-5

Introduction

Congratulations on your choice of the FURUNO FR-1430DS Marine Radar. We are confident you will see why the FURUNO name has become synonymous with quality and reliability.

For over 40 years FURUNO Electric Company has enjoyed an enviable reputation for quality and reliability throughout the world. This dedication to excellence is furthered by our extensive global network of agents and dealers.

While this unit is designed and constructed with much attention to operation and maintenance simplicity, familiarity with its functions and regular maintenance are important for good performance. Please carefully read and follow the recommended procedures set forth in this manual.

We would appreciate feedback from you, the end-user, about whether we are achieving our purposes.

Thank you for considering and purchasing FURUNO equipment.

Features

The following are the main features of the FR-1430DS.

- Echoes are shown in eight levels of high-contrast yellow or in three colors, on a bright 14 inch display screen. Background color is selectable as either black, blue or light-blue.
- All controls respond immediately to the operator's command and each time a key is depressed, the corresponding change can be seen on the screen.
- Daylight bright picture viewable in even the brightest sunlight.
- 8 levels of target quantization for high target definition without problems associated with single-level quantization systems.
- On-screen alpha-numeric readout of all operational information.
- 12 ranges from 0.25 to 96 nautical miles.
- Field-proven, heavy duty gearbox and 250 cm or 270 cm radiator capable of withstanding 100-knot wind velocity.
- Two EBLs (Electronic Bearing Line), two VRMs (Variable Range Marker), Guard Alarm, Offset EBL, Interference Rejector, Echo Stretch and more provided as standard features.

Specifications of FR-1430DS

SCANNER UNIT

1. Type Slotted Array
2. Polarization Horizontal
3. Antenna Rotation 24 rpm nominal
4. Radiator Length & Type

Scanner Name		SN4A	SN5A
Scanner Length		250 cm	270 cm
Horizontal Beamwidth		2.6°	2.3°
Vertical Beamwidth		25°	25°
Sidelobe	within ±20° of mainlobe	less than -23 dB	less than -23 dB
	outside ±20° of mainlobe	less than -25 dB	less than -25 dB

5. Wind Load Relative wind 51.5 m/s (100 knots)

TRANSCEIVER MODULE (contained in scanner housing)

1. Transmitting Tube Magnetron (MG5223F)
2. Frequency & Modulation 3050 MHz ±30 MHz, P0N (S-band)
3. Peak Output Power 30 kW nominal
4. Warm-up Time 3 minutes
5. Pulsewidth & Pulse Repetition Rate

Pulsewidth	Pulse Repetition Rate	Range (nautical miles)											
		0.25	0.5	0.75	1.5	3	6	12	16	24	32	48	96
Short (SP)	Approx. 1900 Hz	0.08 μs											
Medium (M1P)	Approx. 1100 Hz	0.3 μs											
Medium (M2P)	Approx. 600 Hz							0.6 μs					
Long (LP)	Approx. 600 Hz *1							1.2 μs					

*1 Approx. 450 Hz on 96 nm range.

NOTE: When the second-trace echo rejection circuit is on the pulse repetition rate is approx. 450 Hz for pulselengths others than short (SP).

- 6. Modulator SCR Line Type Pulse Modulator
- 7. IF 60 MHz, Logarithmic Amplifier
- 8. Tuning Automatic/Manual
- 9. Receiver Front End MIC (Microwave IC)
- 10. Bandwidth 0.08 μ s pulsewidth: 28 MHz
0.3, 0.6 and 1.2 μ s pulsewidths: 3 MHz
- 11. Duplexer Ferrite Circulator with Diode Limiter
- 12. Spurious Reflection -40 dB nominal

DISPLAY UNIT

- 1. Indication System Raster scan, daylight display
- 2. Picture Tube 14 inch diagonal high resolution color CRT

3. Range (nm)	0.25	0.5	0.75	1.5	3	6	12	16	24	32	48	96
4. Ring Interval (nm)	0.05	0.1	0.25	0.25	0.5	1	2	4	4	8	8	20
5. No. of Range Rings	5	5	3	6	6	6	6	4	6	4	6	6

- 6. Display Mode
 Heading-Up (HU)
 Heading-Up Cursor Gyro (CG) *
 Course-Up (CU) *
 North-Up (NU)*
 True Motion (TM) **

* gyro signal input required
 **gyro signal input and speed input required

- 7. Range Resolution Better than 34 m (bow direction, 1.5 nm range)
- 8. Bearing Resolution Better than 3° (bow direction, 1.5 nm range)
- 9. Minimum Range Better than 28 m (bow direction, 0.25 nm range)
- 10. Bearing Accuracy Within 1°
- 11. Fixed Range Ring & VRM Accuracy Within 1% or 15 m, whichever is the greater

78-143095

- 12. Markers** Fixed Range Rings, Heading Mark, Stern Mark, Variable Range Marker (VRM1 and VRM2), Electronic Bearing Line (EBL1 and EBL2), Index Line, Cross-hair cursor, Guard Alarm Zone, Tuning Bar, North Mark (gyrocompass required)
- 13. Indications** Range, Range Ring Interval, VRM Range, EBL Bearing, Pulselength, Echo Trail (trailing time, time elapsed), Display Mode, Cross-hair Cursor Data (Bearing, Range), Gyrocompass Reading (gyrocompass required), Ship's Speed (speed input required)
- 14. Echo Trailing** Recent 30 sec., 1 min., 3 min., 6 min., 15 min. or 30 min. of target's trail, or continuous trailing. Track can be plotted in single level or 8 levels (selectable).
- 15. Guard Alarm** Bearing/Range operator-settable (alarm can sound on targets entering or exiting the guard area)
- 16. Interference Rejection** Three levels
- 17. Echo Averaging** Three levels
- 18. Display Shift** Display screen center can be shifted (except true motion mode)
- 19. Offset EBL** Floating EBL
- 20. Zoom** Selected area can be doubled in size (except true motion mode, display shift mode, true echo trailing, echo average mode, 0.25nm range)
- 21. Index Line** Provided

ENVIRONMENT CONDITIONS

1. Vibration

Vibration Frequency	Total Amplitude
1 to 12.5 Hz	±1.6 mm
12.5 to 25 Hz	±0.38 mm
25 to 50 Hz	±0.10 mm

2. Ambient Temperature

Scanner Unit: -25°C to +70°C
Display Unit: -15°C to +55°C

3. Humidity

Relative humidity 95% or less at +40°C

POWER SUPPLY & POWER CONSUMPTION

24 VDC, 230W or
100/110/115VAC, 50/60Hz, 1Ø, 330VA (with rectifier)

COLOR

Scanner Unit

Munsell N9.5

Display Unit

Panel: N3.0 newtone No. 5
Cabinet: 2.5GY5/1.5 embossed T25

EQUIPMENT LIST

Complete Set

No.	Name	Type	Qty	Wt. (kg)	Remarks
1	Scanner Unit	SN4A-RSB-0059-N	1	79	250 cm radiator, standard
		SN4A-RSB-0059-I		79	250 cm radiator, w/de-icer
		SN5A-RSB-0059-N		81	270 cm radiator, standard
		SN5A-RSB-0059-I		81	270 cm radiator, w/de-icer
2	Display Unit	RDP-101	1	33	
3	Accessories		1 set		
4	Installation Materials		1 set		
5	Spare Parts		1 set		
6	Gyro Converter	GC-7	1 set		option, built in display unit
7	Cursor Gyro	CG-1400	1 set		
8	Video Plotter	RP-21	1 set		
9	Auto Plotter	ARP-21	1 set		
10	Non Glare Filter	OP03-68			option
11	External Buzzer	OP03-21			
12	Handle	OP03-70			
13	Power Cable	CVV-S 8x2C			
14	Performance Monitor	PM-50			
15	Rectifier Unit	RU-3424		25	option, for display unit, 100/110/220VAC mains
16	Transformer Unit	RU-3305		12.2	option, for de-icer, 110/220VAC mains

1

OPERATIONAL OVERVIEW

Overview

This radar is designed for intuitive operation. If you change a control setting you will see the associated reaction almost immediately on the screen. Each time you make a correct key input the radar releases a beep tone to indicate it has received your command. (Unacceptable key entry releases a series of beep tones.)

Most controls are in panel 1 or on the front panel. Less often-used functions are kept in the menu, which you can access by pressing the [MENU] key.

Contents

Basic Operation	1-3
Turning the power on.....	1-3
Transmitting the radar	1-3
Suspending transmission	1-3
Turning the power off	1-3
Selecting range.....	1-4
Adjusting the GAIN control	1-4
Adjusting the A/C SEA control.....	1-5
Adjusting the A/C RAIN control	1-6
Automatic clutter control.....	1-6
Adjusting CRT brilliance	1-7
Adjusting mark brilliance	1-7
Adjusting range ring brilliance	1-7
Erasing the heading mark/north mark.....	1-7
Selecting display colors.....	1-7
Selecting presentation mode.....	1-8
Measuring Range and Bearing	1-10
Displaying or erasing the fixed range rings.....	1-10
Displaying an EBL or VRM	1-10
Erasing an EBL or VRM.....	1-10
Displaying or erasing the cross-hair cursor.....	1-10
Measuring range	1-11
Measuring relative bearing	1-11
Measuring true bearing	1-12
Floating Origin EBL.....	1-13
Setting the Guard Alarm.....	1-14
Shifting the Display	1-17
Zoom.....	1-18
Echo Trailing.....	1-19
Operation by Menu	1-21
Menu layout.....	1-22
Selecting items on the menu	1-25
Echo stretch.....	1-25
Echo averaging.....	1-26
Radar interference	1-27

Noise interference.....1-27
Pulsewidth1-28
Second trace echo rejection.....1-28
Echo trailing.....1-29
Index line1-29
Ship's speed input.....1-30
Guard alarm type.....1-31
Panel dimmer1-31
Character brilliance.....1-31
Heading mark brilliance.....1-32
Stern mark on or off.....1-32
EBL bearing1-32
VRM unit.....1-32
+ cursor.....1-33
Echo color.....1-33
Function Keys1-35
 Programming the function keys.....1-36
 Executing a program1-36
Panel 3.....1-37
 Degaussing the picture1-38
 Adjustment of gyro reading (technicians only)1-38
 Tuning the receiver (technicians only).....1-38
Description of Controls.....1-39
Markers and Indications.....1-40

Basic Operation

Turning the power on

Before turning on the power be sure there are no personnel or obstructions near the scanner. Turn on the POWER and SCAN(NER) switches. (The SCAN switch is in panel 3 at the upper left-hand corner of the display unit. The switch can be turned on permanently. The scanner does not rotate until transmission is started.)

The total on time, total TX time and the three-minute timer appear. The three-minute timer starts counting down from 3:00 to 0:00, whereupon it changes to "ST-BY," signifying the radar is ready to transmit. The scanner is not rotated until the radar is transmitted.

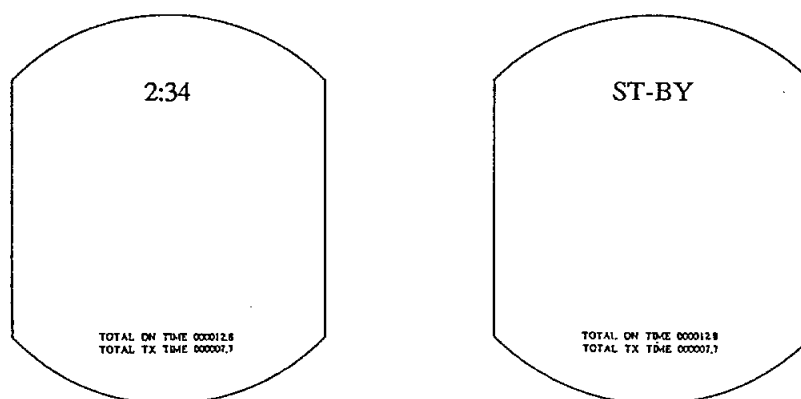

Figure 1-1 Display Screen During and After Warm-up Period

Transmitting the radar

When the message ST-BY appears on the screen, you can transmit the radar by pressing the [ST BY/TX] key. When the radar is transmitting the display screen lights up, and any echoes received from targets appear on the display.

- **NOTE:** You can transmit the radar automatically after completion of the warm-up period by pressing the [ST BY/TX] key during the warm-up period.

Suspending transmission

To suspend transmission temporarily, press the [ST BY/TX] key. (Antenna rotation is also suspended.)

Turning the power off

Press the POWER switch to turn off the radar.

Selecting range

The [RANGE] keys ([-], [+]) select the range. The range selected determines automatically the fixed range ring interval. The range selected and the range ring interval appear at the upper left-hand corner on the screen.

Adjusting the GAIN control

The GAIN control adjusts the sensitivity of the receiver, and thus the strength of echoes as they appear on the screen. Adjust the control so the speckled noise background is just visible on the CRT.

procedure

To adjust the gain;

1. First select one of the three longest ranges—the speckled background is more visible on long ranges.
2. Turn the GAIN control clockwise slowly; you should be able to see the speckled background appear when the control is set between 1 and 3 o'clock.

■ **NOTE:** *If you set up for too little gain, weak echoes may be eliminated. And if you turn the control too far clockwise, yielding too much speckled noise background, targets may be wiped out because of the poor contrast between desired echoes and the background noise on the display.*

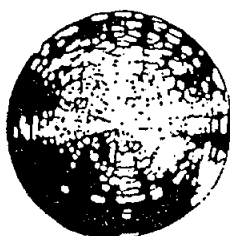

(A) TOO HIGH

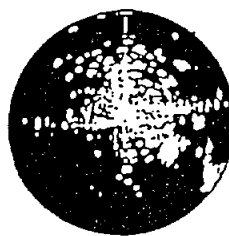

(B) PROPER

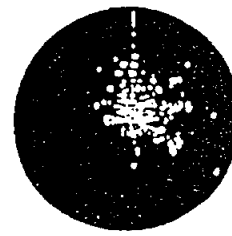

(C) TOO LOW

Figure 1-2 Gain Control Adjustment

Adjusting the A/C SEA control

Sea returns appear on the screen as many small echoes which might affect radar performance. The action of the A/C SEA circuit is to reduce the amplification of echoes at short ranges (where clutter is the greatest) and progressively increase amplification as the range increases, so amplification will be normal at those ranges where there is no sea clutter. The control is effective up to about 8 miles.

procedure

Normally, turn the control clockwise until the clutter has disappeared leeward, but a little is still visible windward.

The proper setting of the A/C SEA control is so the clutter is broken up into small dots, and small targets become distinguishable. If the control is not sufficiently advanced, other targets will be hidden in the clutter, while if it is set too high, both sea clutter and targets will be eliminated.

- **NOTE:** *Always leave a little clutter visible on the screen, to be sure weak echoes will not be eliminated. If no clutter is visible on the screen, leave the control in the fully counterclockwise position.*

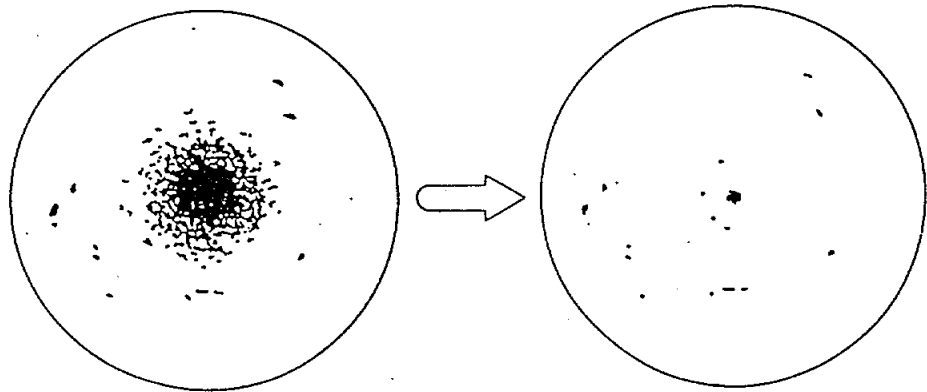

Figure 1-3 Adjusting the A/C SEA Control

Adjusting the A/C RAIN control

The echoes of ships operating inside rain, hail, or snowstorms may be hidden by on-screen rain clutter. Rain clutter is easily recognizable by its wool-like appearance on the screen. When this type of interference obscures a large area of the screen, you can use the A/C RAIN control to reduce the clutter.

procedure

Turn the A/C RAIN control clockwise so clutter is broken into small speckles.

- **NOTE:** *Since the control reduces receiver sensitivity it may also be used in clear weather to separate groups of echoes on a congested short-range picture. In all cases use discretion when adjusting the control, since advancing it too far clockwise may erase target echoes.*

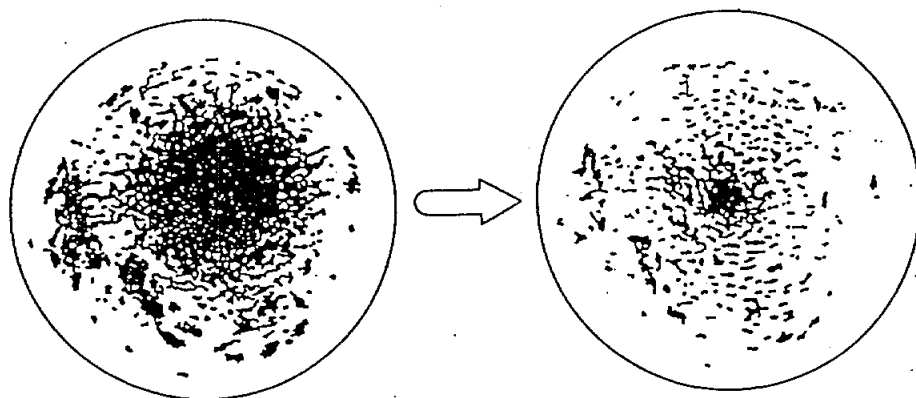

Figure 1-4 Effect of the A/C RAIN Control

Automatic clutter control

The [A/C AUTO] key controls the video circuit which automatically suppresses sea and rain clutters, overriding the manual control for A/C SEA and A/C RAIN. When the circuit is on A/C AUTO appears at the lower left corner of the screen. It is recommended to set the manual A/C SEA and RAIN controls at minimum position when A/C AUTO is used, even though the A/C AUTO overrides them.

Adjusting CRT brilliance

The BRILL control adjusts the brightness of the CRT. Turn it clockwise to increase the intensity of the radar echo blips. Adjust it so radar echo blips may be seen clearly.

Adjusting mark brilliance

The [MARK BRILL] key (panel 1) adjusts the brightness of all markers except the range rings, in steps of dim, medium 1, medium 2 and bright.

Adjusting range ring brilliance

The [RING] key (panel 1) adjusts the brightness of the range rings in steps of dim, medium, bright and off.

- **NOTE:** *The front panel backlighting, on-screen character brilliance and heading mark brilliance can be adjusted through the menu. For further details see "Operation by Menu".*

Erasing the heading mark/north mark

When the radar is on, the heading mark appears. The north mark also appears if the radar is interfaced with a gyrocompass.

procedure

When the heading mark, north mark or stern mark (if turned on thru the menu) masks or hinders recognition of a small target echo;

1. Press and hold down the [HM OFF] key (panel 1) to erase them temporarily.
2. Release hold to redisplay them.

Selecting display colors

You can change the color of the background, markers and on-screen information to suit your taste.

procedure

Press the [COLOR] key (panel 1). The color of the background, markers, on-screen data and echo trail change in the sequence shown in the table below.

Item	Each press of [COLOR]		
	Black	Blue	Light-blue
background color	Black	Blue	Light-blue
fixed range rings, heading mark, on-screen data, north mark, tuning bar	Green	White	
VRM1 and VRM2, EBL1 and EBL2, index line, ship's stern mark, guard alarm zone, cross-hair cursor	Cyan	Green	
echo trailing	Blue	Green	

Selecting presentation mode

This radar offers four or five presentation modes (the choice depending on cursor gyro connection/no connection) when interfaced with a gyrocompass. If there is no gyro signal, however, only Heading-Up is available.

- No cursor gyro program: Heading-Up, Course-Up, North-Up, True Motion
- With cursor gyro program: Heading-Up, Heading Up CG, Course-Up, North-Up, True Motion

Below is a description of each presentation mode.

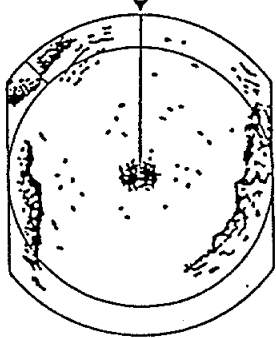
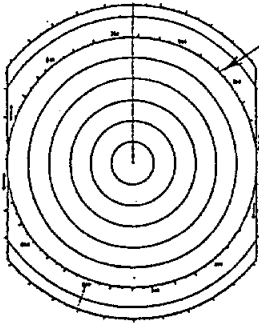
Mode/Description	Sample Display
<p>Heading-Up Mode</p> <p>The picture is oriented so the heading mark appears at the top of the screen. This mode is most suitable for navigation in congested areas or narrow channels. Note that the north mark appears only when a gyrocompass is connected.</p>	 <p><i>Figure 1-5 Heading-Up Mode Display</i></p>
<p>Heading-Up CG Mode (gyrocompass required)</p> <p>The gyro-stabilized bearing scale appears in the Heading-Up mode in addition to the fixed bearing scale, as shown in Figure 1-6. 30 degree digital readout is indicated on the bearing scale. The indication can be changed to 8 point system: N, NE, E ... (by technician).</p>	 <p><i>Figure 1-6 Heading-Up CG Mode Display</i></p>

(continued on next page)

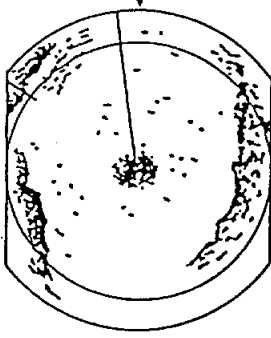
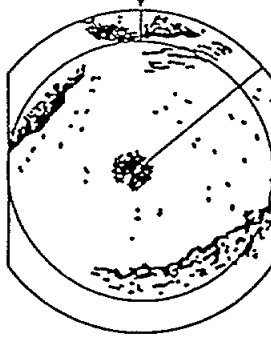
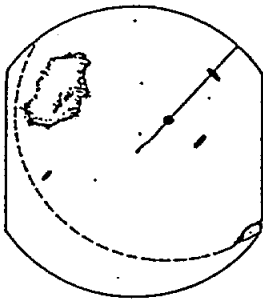
Mode/Description	Sample Display
<p>Course-Up Mode (gyrocompass required)</p> <p>The orientation of the picture is fixed to the top of the screen. The current bow direction, that is, ship's course, is fixed to zero degrees. The heading mark moves according to the ship's movement, but the desired direction always appears at zero degrees.</p>	 <p><i>Figure 1-7 Course-Up Mode Display</i></p>
<p>North-Up Mode (gyrocompass required)</p> <p>The radar picture is stabilized so the North is at the top of the screen and the heading mark changes with ship's heading. This mode is suitable for both measuring the ship's position and as a navigation monitor on a navigational chart. The picture is stabilized against yaw of the vessel, reducing the smearing of target echoes.</p>	 <p><i>Figure 1-8 North-Up Mode Display</i></p>
<p>True Motion Mode (gyrocompass and speed inputs required)</p> <p>Ships and other moving objects move on the display at their true speeds and courses. Stationary objects are fixed on the display thus you can observe movement of own ship and other ships in relation to stationary objects. When the own ship's mark moves 75% of the current range it is automatically returned 75% of that range in the direction of the ship's stern. You can also manually return the mark by pressing the [SHIFT] key in panel 1.</p>	 <p><i>Figure 1-9 True Motion Mode Display</i></p>

Measuring Range and Bearing

Overview

The range to a target may be measured with the fixed range rings (rough estimate) or a Variable Range Marker (VRM, accurate measurement), and the bearing of a target may be measured with an Electronic Bearing Line (EBL).

The range and bearing can be measured also by using the cross-hair cursor. Cursor data appears at the upper left-hand side of the screen.

Displaying or erasing the fixed range rings

Press the [RING] key (panel 1) to display or erase the rings. Continued pressing of the key changes their brilliance in three steps.

Displaying an EBL or VRM

At the right and left side of the front panel there is an [ON] and an [OFF] key and a rotary knob control. An [ON] and [OFF] key pair and their associated rotary knob control operate two VRMs (VRM No.1 and VRM No.2) or two EBLs (EBL No.1 and EBL No.2).

To display an EBL or VRM, press appropriate [ON] key. Each time the key is pressed the readout of the marker operative by the rotary knob control is circumscribed at the bottom left (EBL) or bottom right (VRM) of the display.

Erasing an EBL or VRM

You can erase an EBL or VRM by pressing the associated [OFF] key. If two like markers are on the screen when the [OFF] key is pressed, the inoperative marker is erased.

- **NOTE:** *The dash of the No.1 markers is shorter than that of the No.2 markers.*

Displaying or erasing the cross-hair cursor

The cross-hair cursor can be turned on or off through the menu. For further details, see page 1-33.

Measuring range

Follow the procedure below to measure the range to a target with a VRM.

1. Press the [VRM ON] key. (A VRM appears on the display.)
2. Rotate the VRM rotary knob control so the circle described by the VRM just touches the inside edge of the target blip.
3. Read the readout of the VRM to find the range to the target.

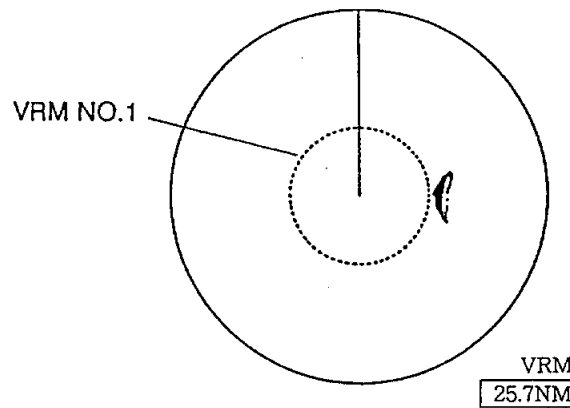

Figure 1-10 How to Measure Range with a VRM

- **NOTE:** The VRM measuring unit of each VRM can be changed to nm or km. For further details, see page 1-32.

Measuring relative bearing

To measure the relative bearing of a target, follow the procedure below.

1. Press the [MODE SELECT] key to select Heading-up mode.
2. Display an EBL on the screen by pressing the [EBL ON] key.
3. Operate the EBL rotary knob control to bisect the target with the EBL.
4. Read the EBL readout to find the bearing to the target.

- **NOTE:** The measuring unit of each EBL can be changed to relative or true. For further details, see page 1-32.

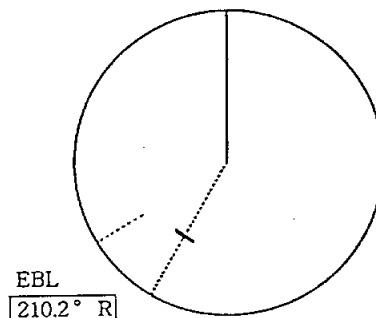

Figure 1-11a How to Measure Relative Bearing with an EBL

Measuring true bearing

To measure the true bearing of a target;

no gyrocompass connection

1. Do steps 1 through 3 of "measuring relative bearing."
2. To find true bearing with no gyrocompass connection;

True Bearing = Relative Bearing + compass reading
If the total exceeds 360° subtract 360° from the total.

gyrocompass connection

1. Press the [MODE SELECT] key to select Course-up, North-up or True Motion mode.
2. Display an EBL on the screen by pressing the [EBL ON] key.
3. Operate the EBL control to bisect the target with the EBL.

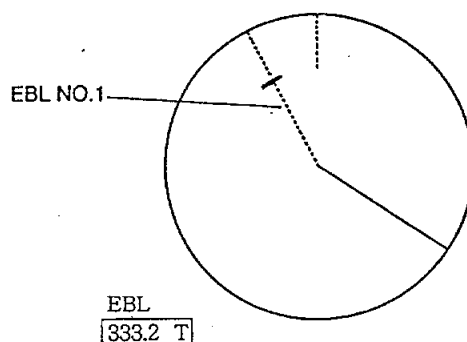

Figure 11b How to Measure True Bearing with an EBL

- **NOTE:** The measuring unit of each EBL can be changed to relative or true in the Heading-up mode, with gyrocompass connection. For further details see page 1-32.

Floating Origin EBL

Overview

The origin of the EBL can be placed anywhere with the trackball to provide measurements of bearing and range between two targets. This function is also useful for evaluating possible collision situations.

Procedure

To measure the range and bearing between two targets;

1. Display an EBL on the screen.
2. Press the [OFFSET EBL] key (panel 1). (The EBL origin is placed at the cursor intersection.)
3. Superimpose the cursor on the target echo desired by operating the trackball.
4. Press the [OFFSET EBL] key again. (The EBL origin is fixed to the selected position.)
5. Wait 3 or 6 minutes, then operate the EBL rotary knob control to bisect the target with the EBL.

NOTE: *If the EBL passes through own ship, the chance of collision exists.*

6. To measure the range between two targets press the [VRM ON] key to display the VRM (No.1 or No.2) associated with the active EBL.
7. Operate the VRM rotary knob control. (The range to the other target appears on the VRM reading at the lower right-hand side of the screen.)

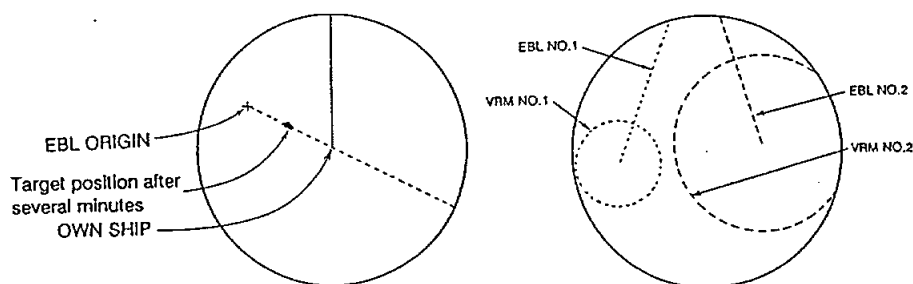

Figure 1-12 Using the Floating EBL

■ **NOTE:** *To measure the range and bearing between two other targets activate the other EBL and VRM.*

8. To return EBL origin to screen center, press the [OFFSET EBL] key again.

Setting the Guard Alarm

Overview

The guard alarm sounds when a target echo above a certain signal level goes into or goes out of the user set guard zone. (Signal level and alarm type are selectable through the menu. For signal level presetting, consult your dealer or technician.) The size of the guard zone may be set between 0 and maximum range for distance and between 0 and 360° in bearing.

Procedure

Follow the procedure below to set a guard zone. The illustration on the next page shows how to set the guard zone.

Item	Step	Action	Result
Setting the guard alarm	1	Mentally create the guard zone you want to display.	
	2	Place the cross-hair cursor at the upper (lower) left edge of the guard zone.	
	3	Press the [GUARD ALARM] key (panel 1).	The indication "GUARD SET" appears at the lower right side of the screen.
	4	Place the cross-hair cursor at the lower (upper) right edge of the guard zone by operating the trackball.	The indication "GUARD SET" remains on the screen.
	5	Press the [GUARD ALARM] key.	The indication "GUARD SET" changes to "GUARD".
Silencing the audible alarm		When the alarm sounds, press the [GUARD ALARM] key to silence the alarm.	The indication "GUARD ACK(nowledge)" replaces "GUARD".
Restoring the audible alarm		Press the [GUARD ALARM] key.	The indication "GUARD" replaces "GUARD ACK".
Canceling alarm and guard zone		Press the [GUARD ALARM] key for more than one second.	The indication "GUARD" and the guard zone are erased.

- **NOTE:** *The guard zone stays on the screen provided the range is not changed to one lower than the guard alarm range. If the range is lower the indication "GUARD" changes to "GUARD UP RNG". Change the range to display the alarm.*

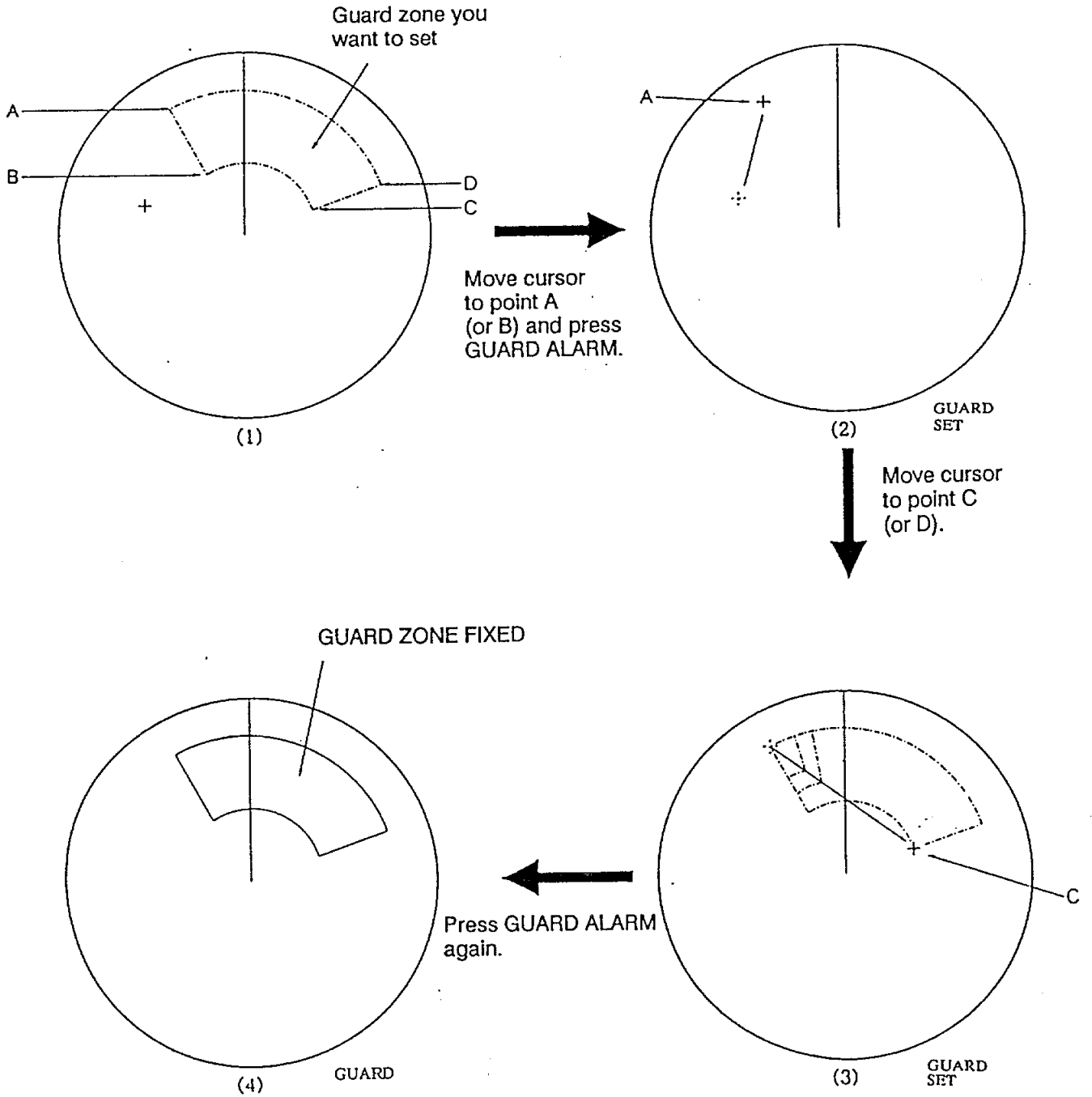

Figure 1-13 How to Set the Guard Zone

Notes and cautions on alarm usage

- **CAUTION:** *The alarm sounds to the targets having a certain level of echo strength. This level does not always imply a landmass, reef, ships or other surface target but can mean returns from sea surface or precipitation. As the level is changeable with the environment, the operator should (properly) adjust the gain and A/C controls. Note however that excessively high position of A/C controls can fail in alerting small targets.*
- **CAUTION:** *The alarm is a useful anti-collision aid, but does not relieve the operator of the responsibility to also keep a visual look-out for possible collision situations. The alarm should not be relied upon as the sole means for detecting possible collision situations. The 1972 Convention on the International Regulations For Preventing Collisions at Sea (1972 COLREGS) provides statutory requirements for the operation of any vessel, including the posting of lookouts. The operator of the vessel is responsible for compliance with those requirements whether or not a radar is in use.*
- **NOTE:** *The guard alarm can be preset to sound either on targets going into or going out of the alarm area. For details see page 1-31.*



Solid lines show examples of when the alarm sounds.

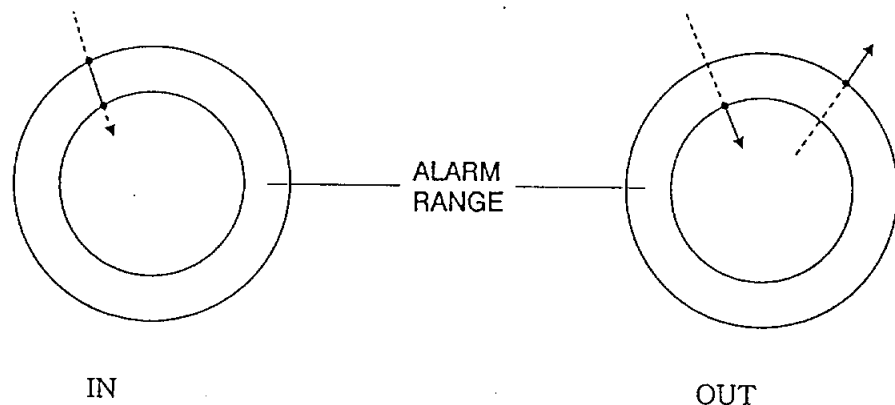

Figure 1-14 How the IN and OUT Guard Alarms Work

Shifting the Display

Overview

The sweep origin can be off-centered to an arbitrary position to provide increased coverage without changing the range.

■ **NOTE:** *The shift function is inoperative in the true motion mode.*

Procedure

Below is the procedure for shifting the display.

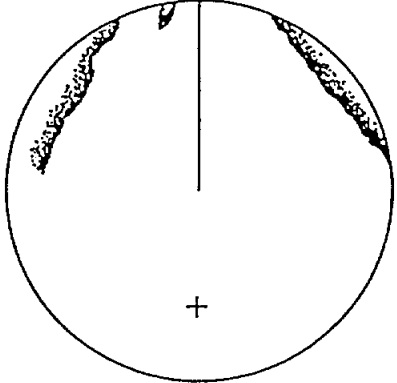
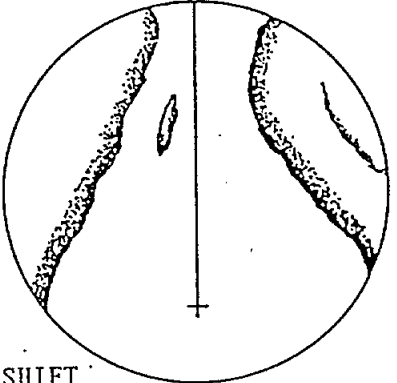
Item	Step	Action	Resulting Display
Turning on the Shift feature	1	Set the cursor where desired, by operating the trackball.	
	2	Press the [SHIFT] key (panel 1) to off center the sweep origin.	
Turning off the Shift feature		Press the [SHIFT] key again.	

■ **NOTE:** *The maximum range of display after off-centering is double the range in use or 1.25 times the range in use when true echo trailing or echo average is selected. The area outside double (or 1.25 times) the range is blank (no targets).*

Zoom

Overview

An area between own ship and an arbitrary location can be doubled with the zoom. This feature lets you take a closer look at an area of interest without changing the range.

- **NOTE:** *The zoom is inoperative during display shift, true trailing mode, true motion mode, echo averaging and on the 0.25 nm range. The zoom is also inoperative on "plot mode" or "radar/plotter combination mode when incorporating optional video plotter.*

Procedure

Here is the procedure to turn on and off the zoom feature.

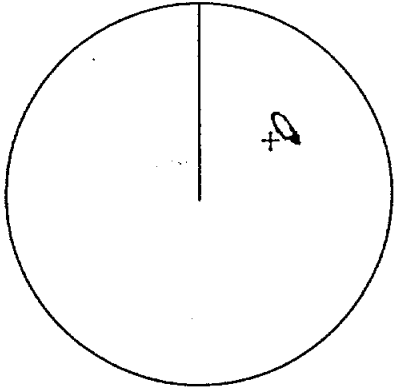
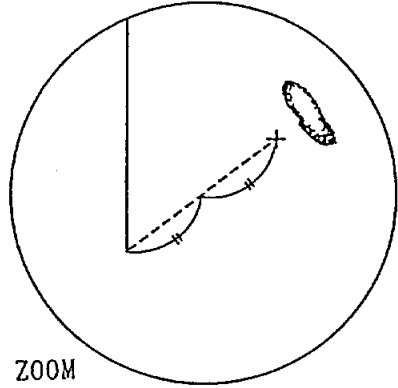
Item	Step	Action	Resulting Display
Turning on the Zoom feature	1	Set the cursor where desired, by operating the trackball.	
	2	Press the [X2 ZOOM] key (panel 1) to turn on the zoom feature.	
Turning off the Zoom feature		Press the [X2 ZOOM] key again.	

- **NOTE:** *The zoom function is automatically canceled when changing the range. Further, turning on display shift, echo averaging or true echo trailing also cancels the zoom.*

Echo Trailing

Overview

The [ECHO TRAIL] key (panel 1) plots the relative (or true) movement of all targets to own ship in blue (for black background) or green (for blue or light-blue background) color. The faster the relative speed of the target, the longer the trail of the target.

The relative trailing mode shows the relative velocity between the targets and own ship. And the true trailing mode (gyrocompass and speed inputs required) shows the true movement of all targets.

The trailing time, trailing mode and trailing gradation can be selected through the menu. These conditions are:

- Trailing time (off, 30 seconds, 1 minute, 3 minutes, 6 minutes, 15 minutes, 30 minutes and continuous)
- Trailing mode (relative or true, selectable on menu)
- Trailing gradation (single or multiple, selectable on menu)

When the trailing circuit is on; for example, 30 seconds trailing time is selected through the menu;

- 1) "30S" appears at the lower right-hand corner of the screen.
- 2) The timer starts counting up and the trail of every target starts extending.
- 3) As soon as the timer counts 30 seconds it stops counting.

■ **NOTE:** For continuous plotting, the timer stays on the screen and counts up from 0.00 to 99.59 and the trail of targets extends continuously.

- 4) The trail of targets are erased from their oldest tip and only the last 30 seconds remain on the screen.

Procedure

1. Press the [ECHO TRAIL] key to start echo trailing.
2. To suspend echo trailing press the [ECHO TRAIL] key again. (The trail of targets do not appear on the screen but trailing continues internally, until the trail is erased through the menu.)

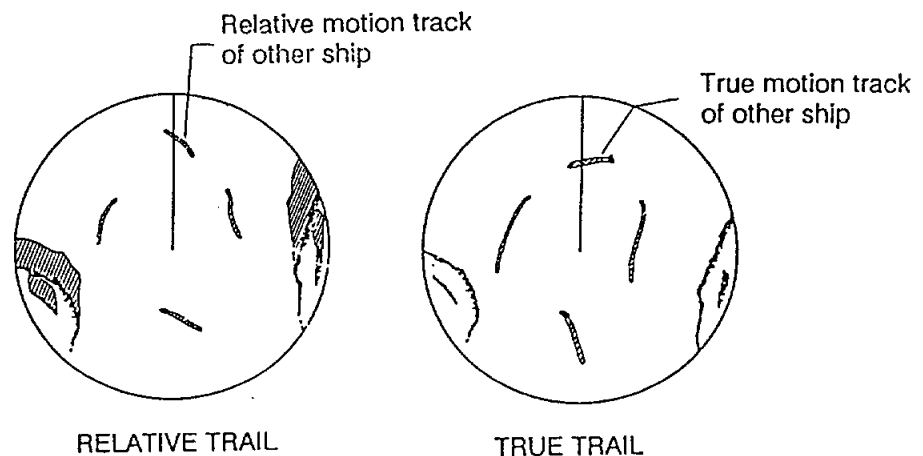

Figure 1-15 Echo Trailing

- **NOTE 1:** *Trailing is temporarily suspended if the range is changed. Return to the previous range setting to resume trailing. Trailing begins again with the elapsed time of zero except for continuous trailing. It is possible (by technician) to change the mode so that the echo trailing can restart at the newly selected range.*
- **NOTE 2:** *In the continuous trailing mode the screen may become full with many targets. In this case, you can erase all trailings through the menu. For further details see page 1-29.*

Operation by Menu

Overview

Less often-used functions are selectable through menus. To call up a menu on the display, press the [MENU] (panel 1) key.

This table describes the functions which you can select through the menus.

Menu Display	Meaning & Function	Page
ECHO STRETCH	Echo Stretch on or off, level	1-25
ECHO AVG	Echo Average on or off, level	1-26
INT REJ	Interference Rejection on or off	1-27
NOISE REJ	Noise Rejection on or off	1-27
PULSE WD	Select pulsewidth; two sets of pulsewidth settings set at installation	1-28
2ND ECHO	Second Echo Trace Rejection on or off	1-28
TRAIL TIME	Echo Trailing Time	1-29
TRAIL	Echo Trailing Mode; relative or true	1-29
TRAIL GRADATION	Echo Trail Gradation; single or multiple	1-29
TRAIL ERASE	Echo Trail (complete) erasure	1-29
IDX LINE	Index Line on or off	1-30
IDX LINE INTVL	Index Line Interval	1-30
SHIP SPD	Automatic or manual input of Ship's Speed	1-30
ALARM	Guard Alarm type; in or out	1-31
PANEL BRIL	Panel Dimmer on or off, level	1-31
CHAR BRIL	Character Brilliance	1-31
HM BRIL	Heading Mark Brilliance	1-32
STERN MK	Stern Mark on or off	1-32
EBL1	EBL1 readout; relative or true	1-32
EBL2	EBL2 readout; relative or true	1-32
VRM1	VRM1 readout; nm or km	1-32
VRM2	VRM2 readout; nm or km	1-32
+ CURSOR	+ Cursor on or off	1-33
+ CURSOR	+ Cursor Bearing; relative or true	1-33
ECHO	Echo Color	1-33
FUNCTION KEY1	Function Key 1 Program (interference rejection, echo stretch, echo averaging, A/C AUTO, pulsewidth, character display, noise rejection)	1-35
FUNCTION KEY2	Function Key 2 Program (interference rejection, echo stretch, echo averaging, A/C AUTO, pulsewidth, character display, noise rejection)	1-36
VIDEO PLOTTER	Video Plotter settings (Video Plotter RP-21 required)	1-34
AUTO PLOTTER	Auto Plotter settings (Auto Plotter ARP-21 required)	1-34
INITIAL SETTING	Initial Settings (for technicians only)	
TEST	Unit Self Test (for technicians only)	

Menu layout

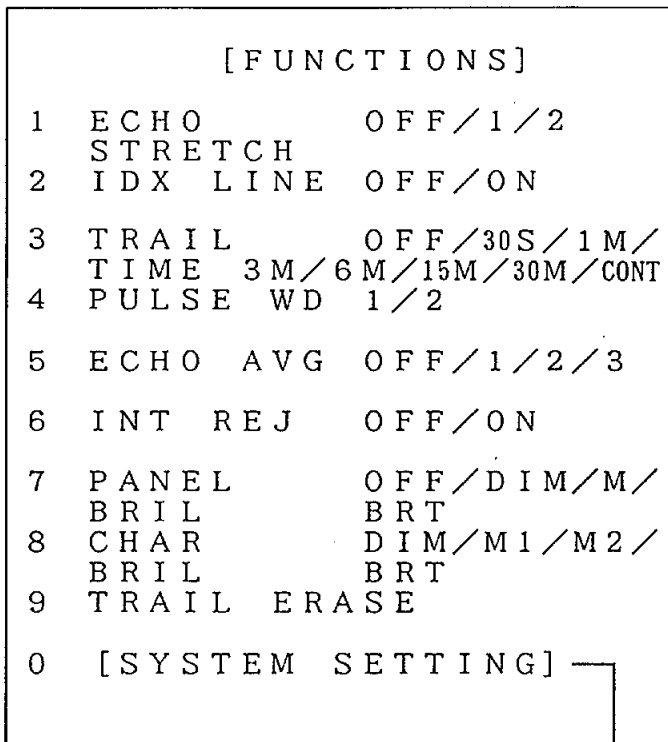

Main Menu

Sub Menu

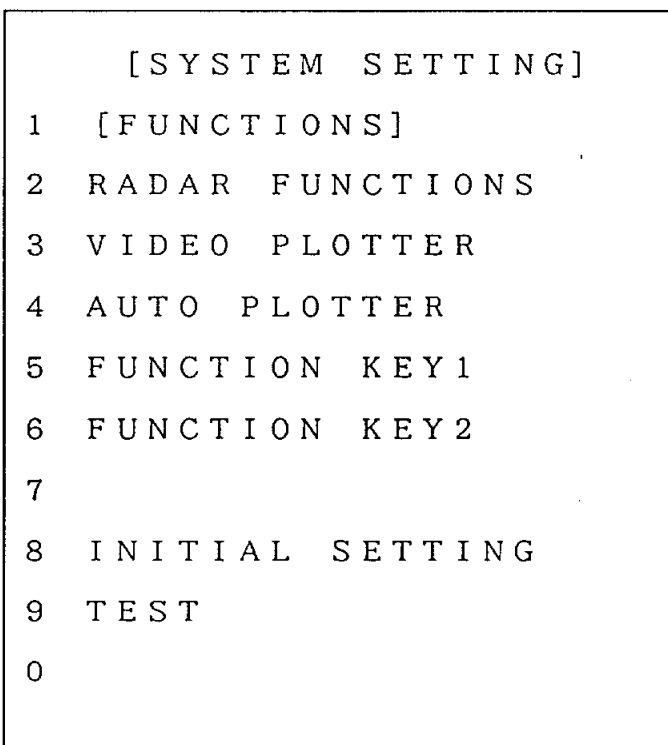

→ Returns to [FUNCTIONS] screen (Main Menu).

→ Selects [RADAR FUNCTIONS 1] screen.

→ Selects [VIDEO PLOTTER] screen.

(When video plotter is incorporated)

→ Selects [AUTO PLOTTER] screen.

(When auto plotter is incorporated)

→ Selects [FUNCTION KEY1] screen.

→ Selects [FUNCTION KEY2] screen.

} For technicians only.
(Key entry not accepted.)

```

[RADAR FUNCTIONS 1]
1 [SYSTEM SETTING]
2 IDX LINE VRM2/MAN
  INTVL      □□. □□NM
3 EBL1      REL/TRUE
4 EBL2      REL/TRUE
5 VRM1      NM/km
6 VRM2      NM/km
7 TRAIL     REL/TRUE
8 SHIP SPD LOG/MAN
            □□. □KTS
9 HM BRIL   DIM/BRT
0 [RADAR FUNCTIONS 2]

```

Returns to [SYSTEM SETTING] screen.

```

[RADAR FUNCTIONS 2]
1 [RADAR FUNCTIONS 1]
2 ECHO      MONO/COLOR
3 TRAIL     SGL/MULTI
  GRADATION
4 RNG UNIT  NM/km
5 STERN MK  NO/YES
6 ALARM     IN/OUT
7 +CURSOR  OFF/ON
8 +CURSOR  REL/TRUE
9 2ND ECHO  OFF/ON
0 NOISE     REJOFF/ON

```

Returns to [RADAR FUNCTIONS 1] screen.

```

[FUNCTION KEY1]
1 [SYSTEM SETTING]
2 INT REJ OFF/1/2/3
3 ECHO OFF/1/2
  STRETCH
4 ECHO AVG OFF/1/2/3
5 A/C AUTO OFF/ON
6 [FUNC 1 PULSE WD]
7 DSP CHAR F1/F2/RIV/
  BY/SHP/BRD/SR/LR
8 NOISE OFF/ON
  REJ
9
0
    
```

Returns to [SYSTEM SETTING] screen.

Function Key (user key) settings

Returns to [FUNCTION KEY1] screen.

```

[FUNC 1 PULSE WD]
1 [FUNCTION KEY1]
2 0.75~1.5NM S/M1
  1.5~3 km
3 3NM M1/M2
  6 km
4 6~24NM M2/L
  12~48 km
5
6
7
8
9
0
    
```

[FUNCTION KEY2] screen contains the same items as the [FUNCTION KEY1] screen.

Selecting items on the menu

The instructions below show how to select items on the menu.

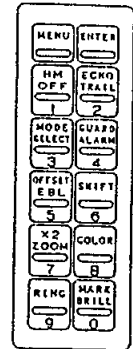

1. Press the [MENU] key (panel 1). (The Main Menu appears on the display.)
2. Press the numeral key in panel 1 corresponding to the item number in the menu you want to select. (The number selected appears in reverse video.)
3. Press the numeral key pressed in step 2 to select setting.
4. Press the [ENTER] key.
5. To confirm menu settings on the radar display, press the [ENTER] key again. (The menu window disappears then the radar display appears for three seconds.)
6. To return to the radar display, press the [MENU] key.

■ **NOTE:** To select the sub menu, press [0]. You select items on sub menus just as you do on the Main menu.

Echo stretch

On long ranges the echoes of targets appear only as small pips, making them difficult to see. To enhance target video on these ranges, you would turn on the echo stretch function. Two levels of echo stretch are available: 1 and 2.

procedure

Follow the procedure below to turn the echo stretch feature on or off.

1. Press the [MENU] key to display the [FUNCTIONS] menu.
2. Press the [1] key to select ECHO STRETCH. ("1" appears in reverse video.)
3. Press the [1] key to select setting.

- OFF: Turns off echo stretch.
- 1: Level 1
- 2: Level 2 (*Inoperative on short pulselength.*)

4. Press the [ENTER] key to register setting.
5. Press the [MENU] key to return to the radar display.

CAUTION: The echo stretch function magnifies not only small target pips but also returns from sea surface and rain and radar interference. For this reason, make sure these types of interference are sufficiently suppressed before using the echo stretch.

Echo averaging

Echoes received from stable targets such as other ships (not moving at a fast relative speed to own ship) appear on the screen at almost the same position for every rotation of the sweep. On the other hand, unstable echoes such as sea clutter appear at random, sometimes making discrimination of target echoes difficult.

To distinguish target echoes from sea clutter, this radar uses the scan-to-scan correlation method. The scan-to-scan correlation method stores and averages successive picture frames. If the echo is stable it appears at its actual strength level. And if it is unstable it is suppressed in brilliance, allowing you to discriminate targets from sea clutter. Also, unstable long-range echoes are stabilized. For effective detection of the stationary target such as buoy, the gyro data and correct own ship's speed data should be entered.

Echo averaging can be turned on without gyrocompass connection (by technician). In this case, however, ship's course change produce negative results.

procedure

To turn echo averaging on or off;

1. If you are going to turn on echo averaging, first suppress sea clutter with the A/C SEA control and be sure gyrocompass and ship's speed readings are correct. (Opposite of intended results will occur if ship's speed is incorrect.)
2. Press the [MENU] key to display the [FUNCTIONS] menu.
3. Press the [5] key to select ECHO AVG. ("5" appears in reverse video.)
4. Press the [5] key to select setting.
 - OFF: Turns off echo averaging.
 - 1: Level 1 (detecting target masked by sea clutter)
 - 2: Level 2 (same as above)
 - 3: Level 3 (detecting unstable long-range echoes)
5. Press the [ENTER] key to register setting. Press the [MENU] key to return to the radar display.

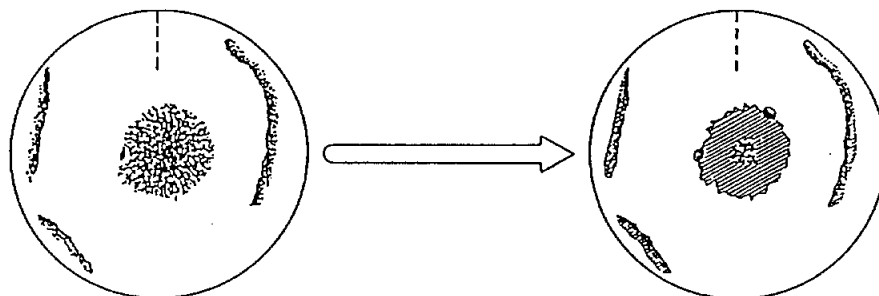

Figure 1-16 Echo Averaging

CAUTION: Avoid using echo averaging when speed difference between own ship and other ships is large or when own ship is in heavy seas.

Radar interference

Radar interference may occur when near another shipborne radar which operates in the same frequency band as this radar.

This type of interference appears on the screen often as many bright dots either scattered at random or in the form of "curved spokes" (see Figure 1-17). You can reduce this interference by turning on the interference rejector circuit.

procedure

Follow the procedure below to turn the radar interference rejection circuit on or off.

1. Press the [MENU] key to display the [FUNCTIONS] menu.
2. Press the [6] key to select INT REJ. ("6" appears in reverse video.)
3. Press the [6] key to select off or on.
4. Press the [ENTER] key to register setting.
5. Press the [MENU] key to return to the radar display.

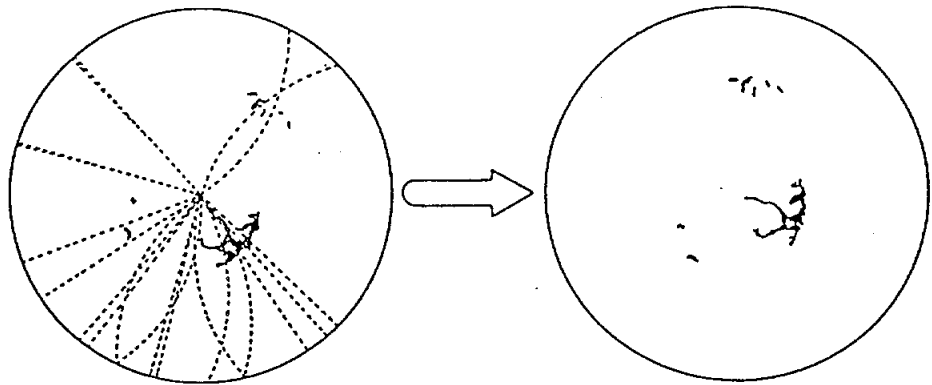

Figure 1-17 Radar Interference

- **NOTE 1:** Turn off the interference rejection circuit when no interference exists. Otherwise targets may be missed.
- **NOTE 2:** Level of interference rejection is selectable among three. (Consult your dealer.)

Noise interference

When the gain is raised white noise will appear on the screen. This noise can be eliminated by turning on the noise rejector in the menu.

procedure

Here is the procedure for turning the noise interference rejection circuit on or off.

1. Press the [MENU] key to display the [FUNCTIONS] menu.
2. Press the [0] key to select [SYSTEM SETTING].
3. Press the [2] key to select the [RADAR FUNCTIONS 1] screen.
4. Press the [0] key to select the [RADAR FUNCTIONS 2] screen.
5. Press the [0] key to select NOISE REJ. ("0" appears in reverse video.)

6. Press the [0] key to select off or on.
7. Press the [ENTER] key to register setting.
8. Press the [MENU] key to return to the radar display.

Pulsewidth

The installing technician enters (on the Initial Settings menu) two sets of pulsewidths for the ranges between 0.75 nm and 24 nm. (The installing technician should make a note of these settings.) You can select one of these two sets of pulsewidths on the Functions menu.

procedure

To select a pulsewidth set;

1. Press the [MENU] key to display the [FUNCTIONS] menu.
2. Press the [4] key to select PULSE WD. ("4" appears in reverse video.)
3. Press the [4] key to select (pulsewidth) 1 or (pulsewidth) 2.
4. Press the [ENTER] key to register setting.
5. Press the [MENU] key to return to the radar display.

■ **NOTE:** *The current pulselength appears on the display as SP, short pulse; M1P, medium pulse 1; M2P, medium pulse 2; LP, long pulse.*

Second trace echo rejection

When the propagation loss of the radio wave is minimal, echoes from very distant targets may appear as false echoes on the screen, returning after the succeeding transmission pulse has been transmitted. You can eliminate these echoes by turning on the second trace echo rejection circuit.

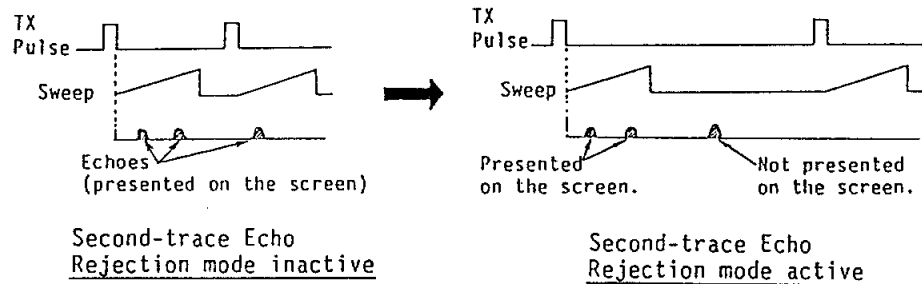

Figure 1-18 How the Second Trace Echo Rejection Circuit Works

procedure

To turn the second trace echo rejection circuit on or off;

1. Press the [MENU] key to display the [FUNCTIONS] menu.
2. Press the [0] key to select [SYSTEM SETTING].
3. Press the [2] key to select the [RADAR FUNCTIONS 1] screen.
4. Press the [0] key to select the [RADAR FUNCTIONS 2] screen.
5. Press the [9] key to select 2ND ECHO. ("9" appears in reverse video.)
6. Press the [9] key to turn the circuit on or off.

7. Press the [ENTER] key to register setting.
8. Press the [MENU] key to return to the radar display. (When the second trace echo rejection is on, the pulsewidth display appears in reverse video.)

- **NOTE 1:** *The number of transmission pulses returning to the radar is reduced when the second trace echo rejection circuit is on. Accordingly, turn off the circuit when its use is not required, so as not to miss target echoes.*
- **NOTE 2:** *The second trace echo rejection circuit is inoperative on ranges of short pulsewidth (SP) even though the pulsewidth display appears in reverse video.*

Echo trailing

You learned earlier how the echo trailing feature works. Now its time to customize it to suit your needs.

trailing time

To select a trailing time;

1. Press the [MENU] key to display the [FUNCTIONS] menu.
2. Press the [3] key to select TRAIL TIME. ("3" appears in reverse video.)
3. Press the [3] key to select a plotting time among OFF, 30S, 1M, 3M, 6M, 15M, 30M and continuous.
If "OFF" is selected, trailing function is completely suspended and [ECHO TRAIL] key (panel 1) is invalid.
4. Press the [ENTER] key to register your selection.

trailing mode

Follow the procedure below to select trailing mode.

1. Press the [MENU] key to display the [FUNCTIONS] menu.
2. Press the [0] key to select [SYSTEM SETTING].
3. Press the [2] key to select the [RADAR FUNCTIONS 1] screen.
4. Press the [7] key to select TRAIL. ("7" appears in reverse video.)
5. Press the [7] key to select relative or true. (*True trailing requires bearing and speed inputs.*)
6. Press the [ENTER] key to register your selection.

trail gradation

To select trailing gradation;

1. Press the [MENU] key to display the [FUNCTIONS] menu.
2. Press the [0] key to select [SYSTEM SETTING].
3. Press the [2] key to select the [RADAR FUNCTIONS 1] screen.
4. Press the [0] key to select [RADAR FUNCTIONS 2] screen.
5. Press the [3] key to select TRAIL GRADATION.
6. Press the [3] key to select single or multiple gradation.
7. Press the [ENTER] key to register your selection.

erasing echo trailings

You can turn the echo trailing feature off with the [ECHO TRAIL] key, however plotting continues internally. This can create confusion when the echo trailing is turned on again; the internally recorded trails will be displayed along with new trails, when the continuous trailing mode is selected. In this case you can erase both

the echo trailings stored in the memory and the echo trailings on the display.

To erase all echo trailings;

1. Press the [MENU] key to display the [FUNCTIONS] menu.
2. Press the [9] key to select TRAIL ERASE. The past echo trailings are cleared and trailing begins again from zero.
3. Press the [MENU] key to return to the radar display.

■ **NOTE:** Select "OFF" on the TRAIL TIME menu to suspend the echo trailing completely.

Index line

You can display an index line parallel with EBL No.2. The index line consists of up to eight lines parallel to the line inscribed through the screen center. It is useful for maintaining a constant distance between own ship and a coastline or partner ship. You control the index line bearing with the EBL control knob (EBL No.2 should be on and active) and the index line interval with the VRM control knob (VRM No.2 should be on and active).

index line on or off

To turn the index line on or off;

1. Press the [MENU] key to display the [FUNCTIONS] menu.
2. Press the [2] key to select IDX LINE.
3. Press the [2] key to turn the index line on or off.
4. Press the [ENTER] key to register your selection.

index line interval

Follow the procedure below to select index line interval (in nm).

1. Press the [MENU] key to display the [FUNCTIONS] menu.
2. Press the [0] key to select [SYSTEM SETTING].
3. Press the [2] key to select the [RADAR FUNCTIONS 1] screen.
4. Press the [2] key and [ENTER] to select IDX LINE INTVL.
5. Press the [2] key to select the VRM2 or MAN and press the [ENTER] key to register your selection.

VRM2 ... the index line interval can be adjusted by the VRM control knob.

MAN the index line interval is preset by the numeral keys thru menu.

If you select the MAN, enter the desired interval with numeral keys and press the [ENTER] key to register the setting.

■ **NOTE:** For interval less than 10 nm enter 0 plus interval. For example, to enter 7 nm, press [0] and [7].

6. Press the [MENU] key to return to the radar display.

Ship's speed input

The true motion display, echo averaging and true echo trailing require (accurate) ship's speed input. The ship's speed may be

input automatically by a speed log, or manually in the absence of speed log input or in case of speed log error.

procedure

To input ship's speed;

1. Press the [MENU] key to display the [FUNCTIONS] menu.
2. Press the [0] key to select [SYSTEM SETTING].
3. Press the [2] key to select the [RADAR FUNCTIONS 1] screen.
4. Press the [8] key to select SHIP SPD.
5. Press the [8] key to select LOG (automatic input) or MAN (manual input) followed by [ENTER] key.
6. To enter speed manually use the numeral keys.

■ **NOTE:** *For speeds less than 10 knots enter leading zero. For example, if the ship's speed is 8 knots, press [0] and [8].*

7. Press the [ENTER] key followed by the [MENU] key to return to the radar display.

■ **NOTE:** *Be sure not to select LOG when there is no log connection, or the ship's speed will always be zero.*

Guard alarm type

The guard alarm may be preset to sound on targets which either enter or exit the guard alarm area. Select either condition through the menu.

procedure

To select guard alarm type;

1. Press the [MENU] key to display the [FUNCTIONS] menu.
2. Press the [0] key to select [SYSTEM SETTING].
3. Press the [2] key to select the [RADAR FUNCTIONS 1] screen.
4. Press the [0] key to select the [RADAR FUNCTIONS 2] screen.
5. Press the [6] key to select ALARM.
6. Press the [6] key to select IN (enter) or OUT (exit).
7. Press the [ENTER] key followed by the [MENU] key.

Panel dimmer

You can adjust the backlighting of the front panel to your liking.

1. Press the [MENU] key to display the [FUNCTIONS] menu.
2. Press the [7] key to select PANEL BRIL.
3. Press the [7] key to select backlighting.
4. Press the [ENTER] key followed by the [MENU] key.

Character brilliance

Follow the procedure below to adjust character brilliance.

1. Press the [MENU] key to display the [FUNCTIONS] menu.
2. Press the [8] key to select CHAR BRIL.
3. Press the [8] key to select brilliance.
4. Press the [ENTER] key followed by the [MENU] key.

**Heading mark
brilliance**

To adjust heading mark brilliance;

1. Press the [MENU] key to display the [FUNCTIONS] menu.
2. Press the [0] key to select [SYSTEM SETTING].
3. Press the [2] key to select the [RADAR FUNCTIONS 1] screen.
4. Press the [9] key to select HM BRIL.
5. Press the [9] key to select brilliance.
6. Press the [ENTER] key followed by the [MENU] key.

**Stern mark
on or off**

When you want to turn the stern mark on or off;

1. Press the [MENU] key to display the [FUNCTIONS] menu.
2. Press the [0] key to select [SYSTEM SETTING].
3. Press the [2] key to select the [RADAR FUNCTIONS 1] screen.
4. Press the [0] key to select the [RADAR FUNCTIONS 2] screen.
5. Press the [5] key to select STERN MK.
6. Press the [5] key to turn the stern mark on or off.
7. Press the [ENTER] key followed by the [MENU] key.

EBL bearing

You can get, with gyrocompass connection, true or relative bearings for each EBL. (Note that the bearing readout in the Course-up, North-up and True Motion modes is always true.)

To select relative or true bearing;

1. Press the [MENU] key to display the [FUNCTIONS] menu.
2. Press the [0] key to select [SYSTEM SETTING].
3. Press the [2] key to select the [RADAR FUNCTIONS 1] screen.
4. Press the [3] key to select EBL1.
5. Press the [3] key to select TRUE or REL(ative).
6. Press the [4] key to select EBL2. Press the [4] key to select true or relative.
7. Press the [ENTER] key followed by the [MENU] key.

VRM unit

You can display VRM range in nautical miles or kilometers.

1. Press the [MENU] key to display the [FUNCTIONS] menu.
2. Press the [0] key to select [SYSTEM SETTING].
3. Press the [2] key to select the [RADAR FUNCTIONS 1] screen.
4. Press the [5] key to select VRM1.
5. Press the [5] key to select NM or KM.
6. Press the [6] key to select VRM2.
7. Press the [6] key to select unit.
8. Press the [ENTER] key followed by the [MENU] key.

+ cursor The cross-hair cursor can be turned on or off and its bearing displayed in true or relative bearings.

■ **NOTE:** *The cursor bearing readout in the north-up and true motion modes is always true.*

**turning cursor
on or off**

To turn the cursor on or off;

1. Press the [MENU] key to display the [FUNCTIONS] menu.
2. Press the [0] key to select [SYSTEM SETTING].
3. Press the [2] key to select the [RADAR FUNCTIONS 1] screen.
4. Press the [0] key to select the [RADAR FUNCTIONS 2] screen.
5. Press the [7] key to select + CURSOR.
6. Press the [7] key to turn the cursor on or off.
7. Press the [ENTER] key.

**cursor
bearing format**

To display relative or true cursor bearing;

1. At the [RADAR FUNCTIONS 2] screen, press the [8] key to select + CURSOR.
2. Press the [8] key to select true or relative bearing.
3. Press the [ENTER] key followed by the [MENU] key.

Echo color

You may display echoes in colors of red, yellow and green, corresponding to signal levels of strong, medium and weak, or eight levels of yellow.

procedure

Below is the procedure to select echo color.

1. At the [RADAR FUNCTIONS 2] screen, press the [2] key to select ECHO.
2. Press the [2] key to select MONO (eight levels of yellow) or COLOR (red, yellow, green).
3. Press the [ENTER] key followed by the [MENU] key.

[VIDEO PLOTTER]		
1	[SYSTEM SETTING]	
2	GRIDS	DIM/M1/M2/ BRIL BRT
3	TRACK	DIM/M1/M2/ BRIL BRT
4	CHART	DIM/M1/M2/ BRIL BRT
5	MARK	DIM/M1/M2/ BRIL BRT
6	CHAR	DIM/M1/M2/ BRIL BRT
7		
8		
9		
0		

These are the system settings for Video Plotter RP-21 (optional supply).

Returns to [SYSTEM SETTING] screen.

L/L Grid Brilliance
DIM/MEDIUM1/MEDIUM2/BRIGHT
Trackline Brilliance
DIM/MEDIUM1/MEDIUM2/BRIGHT
Chart Brilliance
DIM/MEDIUM1/MEDIUM2/BRIGHT
Mark Brilliance
DIM/MEDIUM1/MEDIUM2/BRIGHT
Character Brilliance
DIM/MEDIUM1/MEDIUM2/BRIGHT

Figure 1-19 Video Plotter Sub Menu

[AUTO PLOTTER]		
1	[SYSTEM SETTING]	
2	INTERVAL	15S/30S/1M /2M/3M/6M/10M/12M
3	HISTORY POINTS	0/5/10
4	DISPLAY	DIM/M1/M2/ BRIL BRT
5		
6		
7		
8		
9		
0		

These are the system settings for Auto Plotter ARP-21 (optional supply).

Returns to [SYSTEM SETTING] screen.

Plotting Interval
15S/30S/1M/2M/3M/6M/10M/12M
History
5pts./10pts./20pts./50pts.
Display Brilliance
OFF/DIM/MEDIUM/BRIGHT

Figure 1-20 Auto Plotter Sub Menu

Function Keys

Overview

The two function keys at the bottom left of the display unit store programs. The primary use of the function keys is to set up the radar for detection of specific targets such as ships, birds or buoys. Instead of adjusting controls manually, you can define a program to perform the task automatically.

Your technician can assist you in determining programs suited to your needs and applications.

The figure below shows the location of these keys.

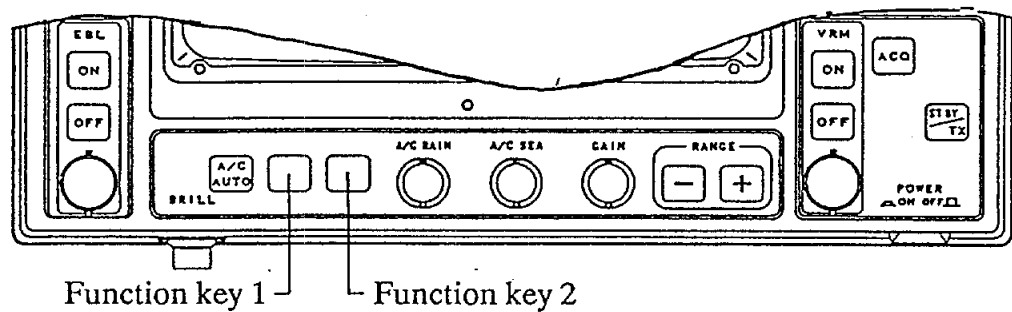

Figure 1-21 Function Keys

This table shows some of the radar functions which can be programmed into a function key.

Function	Setting
Echo Stretch	OFF, level 1 or 2
Echo Average	OFF, level 1, 2 or 3
Interference Rejection	OFF, level 1, 2 or 3
Automatic A/C	OFF or ON
Noise Rejection	OFF or ON
[FUNC 1 PULSE WD]	Pulsewidth selection for 0.75 to 24 nm
Display Screen Indication	F1 (Function 1), F2 (Function 2), RIV(ER), BY (Buoy), SHP (Ship), BRD (Bird), SR (Short Range), LR (Long Range)

Programming the function keys

Follow the procedure below to program the function keys.

1. Press the [MENU] key to display the [FUNCTIONS] menu.
2. Press the [0] key to display the [SYSTEM SETTING] menu.
3. Press the [5] key to display the [FUNCTION KEY1] menu. (This menu is for setting function key 1, the left-hand function key.)
4. Press the [2] key.
5. Select settings.
6. Press the [ENTER] key.
7. Do similar procedure as steps 4 through 6 to set items 3 through 8.
8. Detach appropriate key label (supplied with accessories package) and attach it to function key 1.



Figure 1-22 Function Key Labels

9. To program the right-hand function key (function key 2);
 - a) Press the [1] key to return to the [SYSTEM SETTING] menu.
 - b) Press the [6] key to display the [FUNCTION KEY2] menu.
 - c) Enter settings like you did for the left-hand function key.
 - d) Press the [MENU] key.

Executing a program

Each press of a function key turns on or off the program assigned to that key. The name of the program selected (key label) appears on the display when a function key is on.

Panel 3

Overview

Panel 3 contains the SCAN switch, TUNE switch, TUNE potentiometer, DEGAUSS switch, GYRO switches and LED CR1.

Controls other than the SCAN switch and DEGAUSS switch are intended for use by service technicians. Do not adjust other controls; improper adjustment can degrade performance.

The figure below shows these controls.

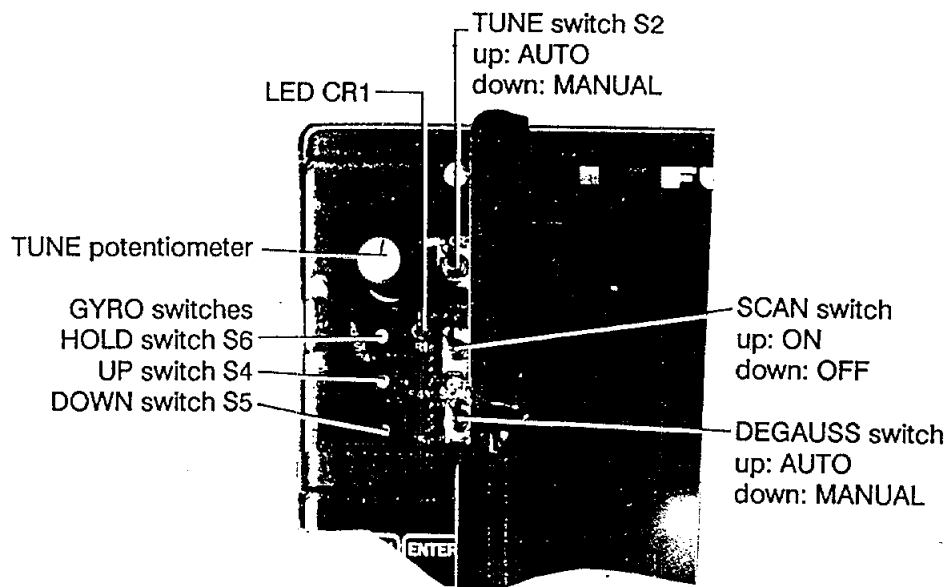

Figure 1-23 Display Unit, Panel 3 opened

This table details the functions of each control.

Part	Function
SCAN switch	Turns the scanner on or off.
TUNE switch S2	Enables automatic or manual tuning.
TUNE potentiometer	Adjusts tuning, when set to "manual."
GYRO switches HOLD switch S6 UP switch S4 DOWN switch S5	Adjust gyro reading on display.
LED CR1	Lights during adjustment of gyro reading.
DEGAUSS switch	Enables automatic or manual CRT degaussing.

Degaussing the picture

You may observe color fading on the display due to ship's construction or variations in earth's magnetism. Each time the power is applied the CRT is degaussed automatically. When the ship turns, the CRT is also degaussed automatically and the lines appear vertically at the center of the CRT.

procedure

To degauss the screen manually;

Set the DEGAUSS switch to the manual setting. (When you release the switch it automatically returns to the automatic setting.)

- **NOTE:** *If the screen is not degaussed the first time wait at least 30 seconds before trying again.*

Adjustment of gyro reading (technicians only)

North-up and Course-up mode require the compass signal in step-by-step or synchronous form. The compass preset is performed as follows by using the controls in panel 3. This adjustment is required when the radar is first installed or if the gyro reading is in error.

procedure

Below is the procedure for adjusting the gyro reading.

1. After making sure the gyrocompass is working, turn the radar power on. (You should see the indication "HDG" at the top of the radar screen.)
2. Press switch S6 to disengage the computing circuit from the gyrocompass. (LED CR1 lights.)
3. Press switch S4 [UP] or S5 [DOWN] to duplicate the gyrocompass reading at the top of the screen.
4. Press switch S6. (LED CR1 extinguishes.)

- **NOTE:** *If the HDG reading on the radar display deviates from the gyrocompass reading after initial setting, simply press switch S4 or S5 to correct it.*

Tuning the receiver (technicians only)

The radar receiver is tuned automatically each time the power is turned on, thus there is no front panel control for adjustment of the receiver. A tuning bar and the indication AUTO at the top right-hand corner of the display show the tuning circuit is working.

procedure

The receiver can be tuned (by a technician) manually by;

Setting the TUNE switch S2 to MANUAL and adjusting the TUNE potentiometer.

Description of Controls

Panel 3

This panel contains:

- TUNE switch
- TUNE potentiometer
- SCAN switch
- DEGAUSS switch
- Gyro adjustment switches

Controls other than the SCANNER switch and DEGAUSS switch are intended for use only by technicians.

Panel 1

[MENU] key
Displays or erases the FUNCTIONS menu (main menu).

[ENTER] key
Records key input.

[HM OFF] key
Erases the heading mark when pressed and held down.

[ECHO TRAIL] key
Turns the echo trailing feature on or off.

[MODE SELECT] key
Selects radar display mode.

[GUARD ALARM] key
Turns the guard alarm on or off.

[OFFSET EBL] key
Places EBL origin at cursor intersection, or returns EBL origin to screen center.

[SHIFT] key
Turns the display shift feature on or off.

[X2 ZOOM] key
Turns the zoom feature on or off.

[COLOR] key
Selects background color.

[RING] key
Turns fixed range rings off and adjusts their brilliance in three steps.

[MARK BRILL] key
Adjusts the brilliance of on-screen markers in four steps.

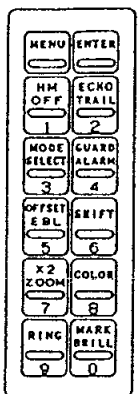

[EBL ON] key
Activates or deactivates EBL No.1 or EBL No.2. The readout of the active EBL is circumscribed.

[EBL OFF] key
Erases the EBL whose readout is not circumscribed.

EBL ROTARY KNOB control
Rotates the EBLs.

ROM CARD DRIVE
(for use with optional Video Plotter RP-21)

BRILL control
Adjusts the brilliance of the CRT.

[A/C AUTO] key
Turns the automatic A/C circuit on or off.

FUNCTION keys (keys with no label in figure)
Replay programs.

A/C RAIN control
Reduces rain clutter.

A/C SEA control
Reduces sea clutter from waves.

GAIN control
Adjusts radar receiver sensitivity.

RANGE keys ([-], [+])
Select radar range.

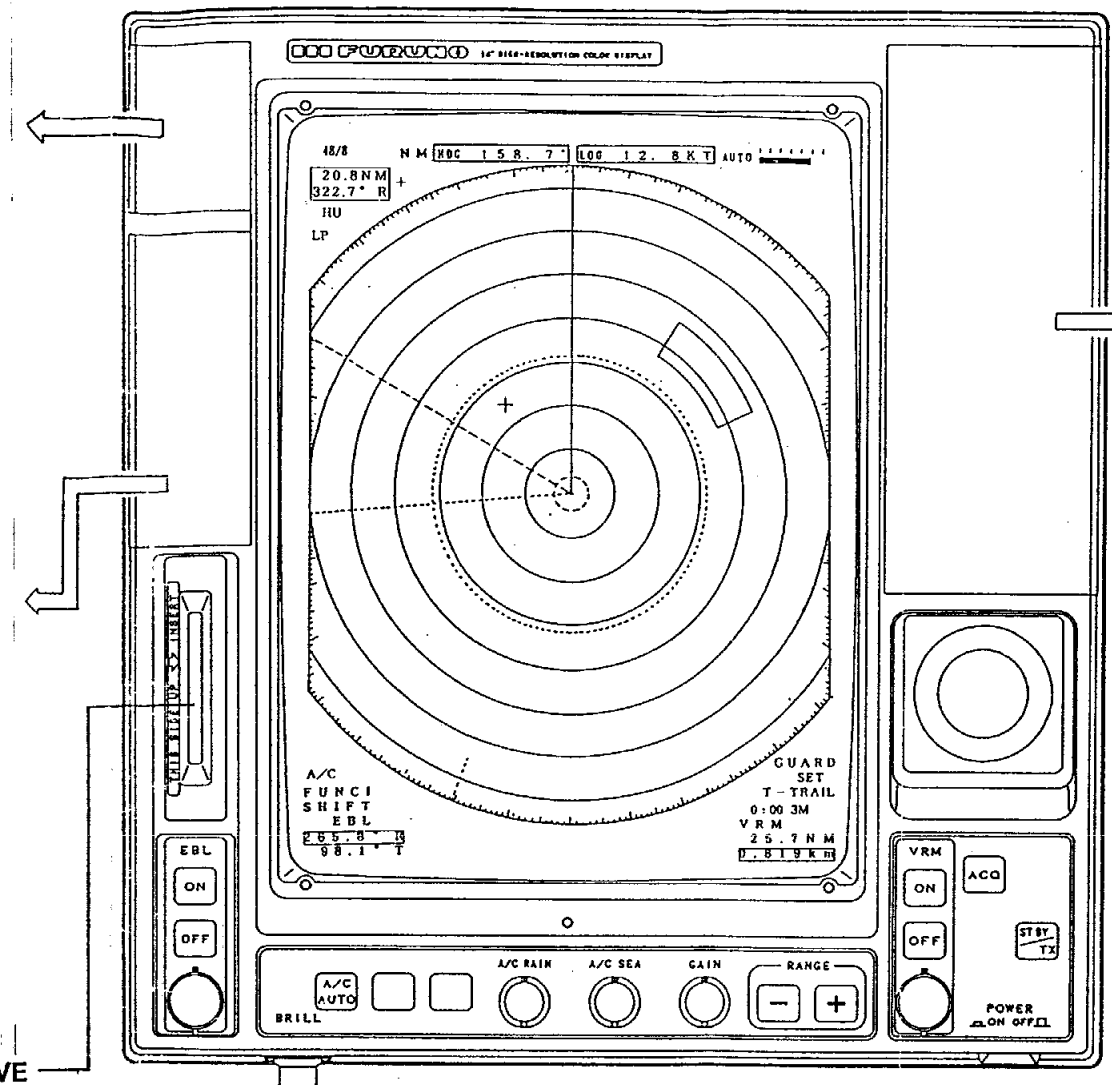

Figure 1-24 Display Unit

Panel 2

This panel contains the controls for operation of the optional Video Plotter RP-21 and Auto Plotter ARP-21.

[VRM ON] key
Activates or deactivates VRM No.1 or VRM No.2. The readout of the active VRM is circumscribed.

[VRM OFF] key
Erases the VRM whose readout is not circumscribed.

VRM ROTARY KNOB control
Adjust VRM radius.

POWER switch
Turns the radar system on or off.

[ST BY/TX] key
Transmits the radar or places the radar in stand-by.

[ACQ] key
For use with optional Auto Plotter ARP-21.

TRACKBALL
Follows the on-screen movement of the cross-hair cursor.

MARKERS AND INDICATIONS

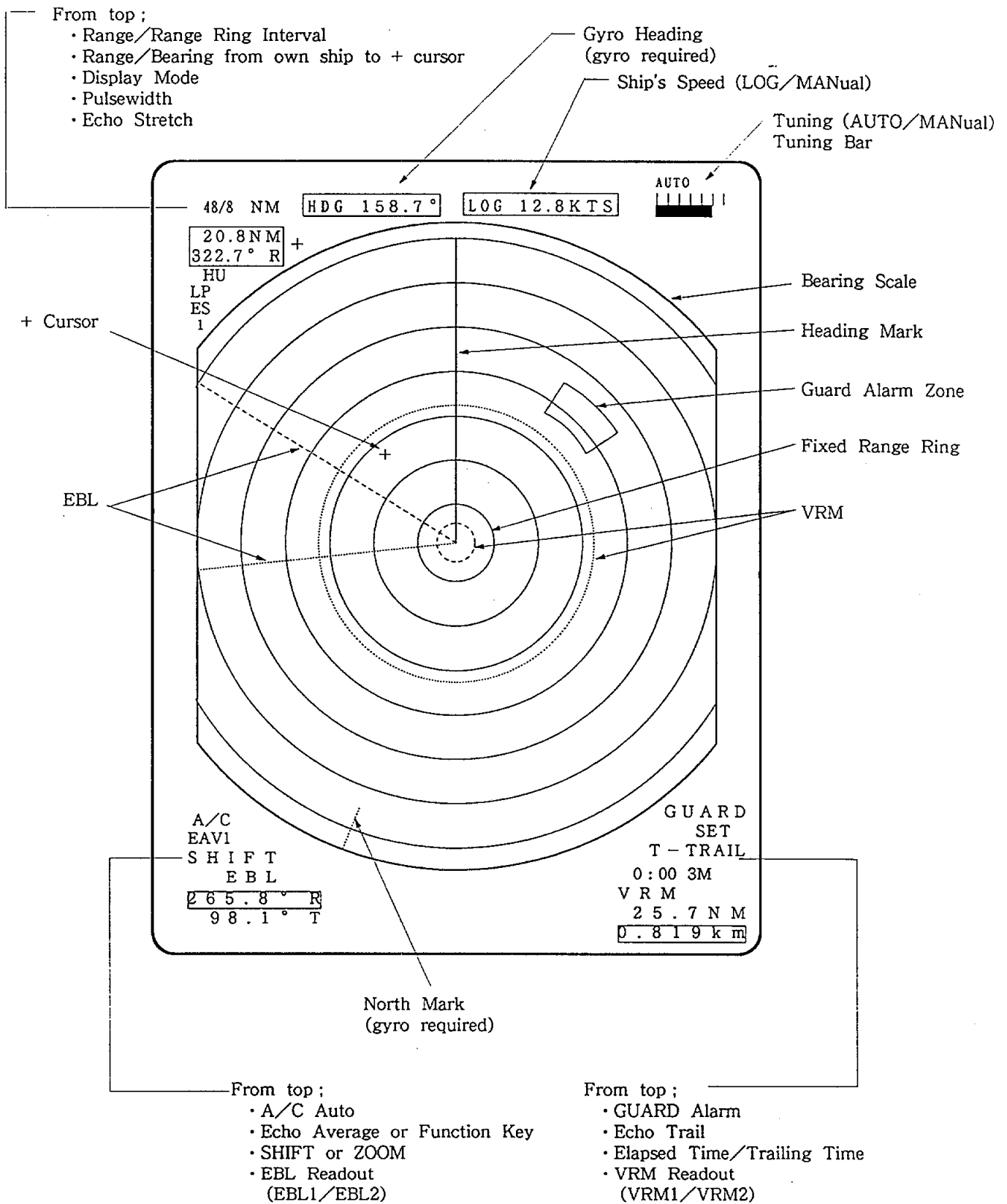

Figure I-25 Markers and Indications

2

APPLICATION

Overview

As an aid to navigation, radar can be a very valuable tool. No other navigation aid can give you the ability to spot vessels coming at you in the fog, or tell you the location of the inlet to the harbor in the pitch black of night. To help you understand better what your radar can and cannot do for you this section covers the characteristics and limitations of radar, picture interpretation, and position fixing with radar.

Contents

Factors Affecting Minimum Range	2-2
Sea return	2-2
Vertical beamwidth	2-2
Factors Affecting Maximum Range.....	2-3
Radar horizon	2-3
Target properties	2-4
Interpreting the Display	2-5
Land targets.....	2-5
Ship targets.....	2-6
Echo size	2-6
False Echoes	2-7
Multiple echoes	2-7
Side-lobe echoes.....	2-7
Blind and shadow sectors	2-8
Indirect echoes.....	2-8
Radar Picture and Corresponding Chart.....	2-10
Position Fixing with Radar.....	2-11
By radar range.....	2-11
By range and bearing to a point of land	2-11
By two bearings.....	2-12
Collision Avoidance and Relative Motion	2-13
Assessing the risk.....	2-14

Factors Affecting Minimum Range

Overview

Targets disappearing from the screen when at close ranges can be dangerous. For this reason, detection of targets at short ranges is very important. Minimum range is determined primarily by transmitter pulselength. The shorter the transmission time, the sooner the return echoes can be received and their distance measured. This radar automatically determines the pulselength for both short and long ranges, for optimal detection of targets on all ranges.

Sea return

Sea clutter echoes received from waves may hamper detection of targets beyond the minimum range set by the pulselength and recovery time. (Recovery time is the time required for the receiver to recover to half sensitivity after the end of a transmitted pulse, so it can receive a return echo.) Proper adjustment of the A/C SEA control may alleviate some of the problem.

Vertical beamwidth

The ability to see targets very close to the boat is decreased if the antenna is mounted too high off the water, since the bottom of the vertical beam of the scanner cuts off nearby targets. Figure 2-1 illustrates the effects of a scanner mounted too high off the water.

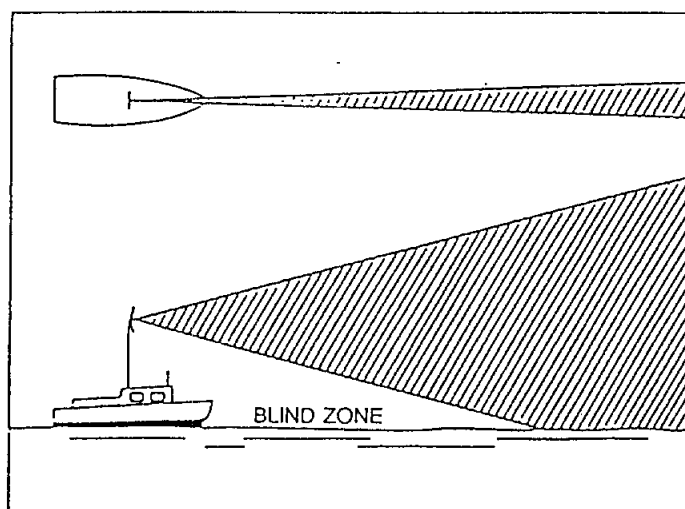

Figure 2-1 Effects of a Scanner Mounted too High off the Water

Factors Affecting Maximum Range

Overview

It is nearly impossible to state that a radar has a maximum range. The maximum range a radar will "see" is dependent on many factors, not just the range marked on the screen. Not only does the sensitivity of the receiver and power of the transmitter but also the height above the water of both the scanner and target, the size, shape and composition of the target, and atmospheric conditions contribute to increase or decrease the maximum detectable range.

Radar horizon

Radar is by its very nature essentially a "line-of-sight" phenomenon. That means that you have just about the same range to horizon with a radar as you do with your own eyes. However under normal atmospheric conditions, the radar horizon is 6% greater than the optical horizon. Therefore, if the target does not rise above the horizon the radar beam cannot be reflected from the target.

Just as you can see a low-to-the-water speedboat only up relatively close to your boat, the radar can see a target high off the water farther than it can see an object which is close to the water. Further, the higher the antenna is mounted over the water the farther it is capable of seeing other targets. However a possible negative effect with mounting the antenna too high off the water is that due to the finite vertical beamwidth of the scanner, the amount of sea clutter due to reflections from nearby waves is increased to a greater distance from the boat.

Thus it is not at all uncommon to see a 3000 foot high mountain 50 miles away (provided the radar has a 50 nautical mile detection capability), while at the same time being only able to see a small power boat 3 or 4 miles away. (See Figure 2-2.)

The distance to the horizon from the scanner, under normal conditions, is calculated by the following formula.

$$R_{\max} = 2.2 \times (\sqrt{h_1} + \sqrt{h_2})$$

Where R_{\max} : Radar horizon (mile), h_1 : Antenna height (meters), h_2 : Target height (meters)

For example, to find the distance to the horizon in Figure 2-2, if the antenna height is 8 meters (26 feet) and the target height is 15.2 meters (50 feet) the maximum range is (when the cliff begins to appear on the radar);

$$R_{\max} = 2.2 \times (\sqrt{8} + \sqrt{15.2}) = 14.8 \text{ miles.}$$

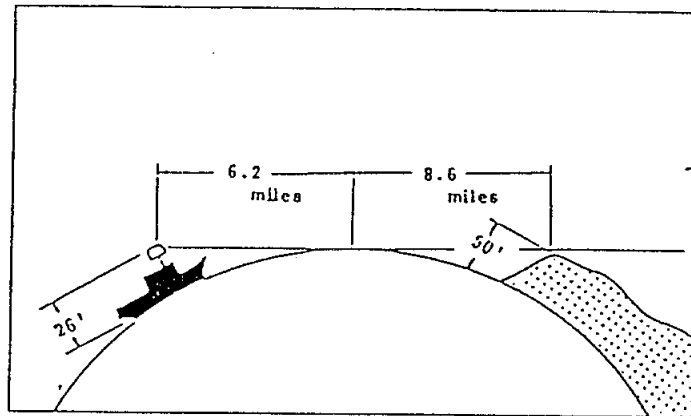

Figure 2-2 Radar Horizon

Target properties

Generally, larger targets can be seen on the radar display at greater ranges, provided line-of-sight exists between the scanner and target. However, a large target with poor reflecting properties may not be detected as easily as a smaller target with better reflecting properties.

Since one of the main functions of radar is to detect other ships, the composition of a target ships' hull affects the detection range. A ship whose hull is made of conducting materials, such as steel, will return a relatively strong echo.

On the other hand, hulls made from wood or fiberglass return much weaker echoes.

Vertical surfaces, such as a cliff, are good targets provided they face the radar. Conversely, horizontal and smooth surfaces such as mudbanks, sandy beaches, and gently sloping hills make poor targets because they disperse rather than reflect most of the energy that strikes them.

The strongest radar echoes known come from built-up areas, docks, etc., because these targets are less subject to changes in aspect. These types of targets have three flat, smooth surfaces mutually at right angles. Some radar buoys are arranged this way so as to deliberately increase their detection range.

Interpreting the Display

Overview

In the previous section some of the characteristics and limitations of radar were discussed. Now its time to take a look at what you can expect to see on the radar screen. What shows up on the screen isn't likely to match exactly what is seen on a navigation chart. A radar cannot see through a mountain in the path between your boat and the harbor, nor can it see a small boat directly behind a large ship, since both the mountain and the larger vessel effectively shield the radar from the desired target.

To aid you in target identification, the echoes appearing on the display are quantized in eight levels, according to their intensity. The brightest intensity echoes are probably from steel ships, or piers, or other "good" targets. Poor targets, for example, wooden boats, appear in the weakest intensities.

The ability to interpret a radar picture comes through practice and experience. Practice should be done during clear weather in daytime, since you can compare the picture with what you actually see around you. Go to an area you are familiar with and compare the way coastlines, buoys and other targets appear on the screen and the way they are drawn on a navigation chart. To observe the movement of an echo in relation to your position, try running your boat at various speeds and headings.

Land targets

Landmasses are readily recognizable because of the generally steady brilliance of the relatively large areas painted on the display. Knowledge of the ship's navigational position will also tell you where land should be. On relative motion displays (this radar), landmasses move in directions and at rates opposite and equal to the actual motion of your own ship. Various factors such as distortion from beamwidth and pulselength make identification of specific features difficult. However, the following may serve as an aid to identification.

- 1) High, steep, rocky and barren landmasses provide good reflecting surfaces.
- 2) Low, vegetation covered lands make poor radar targets.
- 3) Submerged objects do not produce echoes.
- 4) Mud flats, marshes, sandspits, and smooth, clear beaches make poor targets because they have almost no area that can reflect energy back to the radar.
- 5) Smooth water surfaces such as lagoons and inland lakes appear as blank areas on the display — smooth water surfaces return no energy.
- 6) Although you might expect an object as large as a lighthouse to be a good radar target, in actuality the return echo is weak since the conical shape diffuses most of the radiated energy.

Ship targets

A bright, steady, clearly defined image appearing on the display is in all likelihood the target pip of a steel ship. There are several clues which can aid you in identification of a ship. Check your navigational position to rule out the possibility that a target pip is actually a landmass. Land and precipitation echoes are much more massive in appearance than the target pips of ships—which are relatively small. The rate of movement can eliminate the possibility that the pip is an aircraft.

A target pip may brighten and become dim due to changes in aspect and other factors. In most cases however a pip will fade from the display only when the range becomes too great.

Echo size

As the radar beam rotates, the appearance of a pip on the display screen will begin as soon as the leading edge of the radar beam strikes the target. The pip will continue to be seen on the display screen until the trailing edge of the beam rotates beyond the target. Thus, a target cannot appear less wide than the beamwidth. As the beam widens with distance from the scanner, so also will the widths of targets vary on the display. Figure 2-3 illustrates the relationship between beamwidth and the appearance of a target pip.

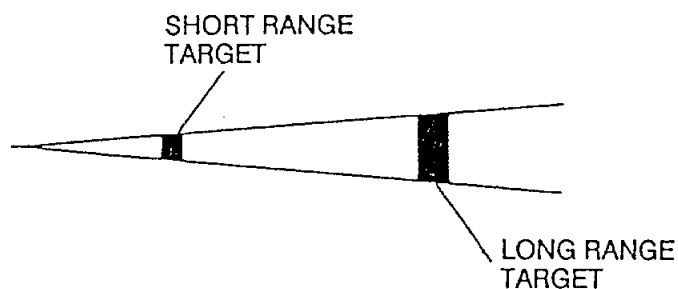

Figure 2-3 Beamwidth Versus Target Appearance

False Echoes

Overview

Occasionally false echoes appear on the screen at positions where there is no target. In some cases the effects can be reduced or eliminated. The operator should familiarize himself with the appearance and effects of these false echoes, so as not to confuse them with echoes from legitimate contacts.

Multiple echoes

Multiple echoes occur when a short range, strong echo is received from a ship, bridge, or breakwater. A second, a third or more echoes may be observed on the display at double, triple or other multiples of the actual range of the target as shown in Figure 2-4. Multiple reflection echoes can be reduced and often removed by decreasing the gain or properly adjusting the A/C SEA.

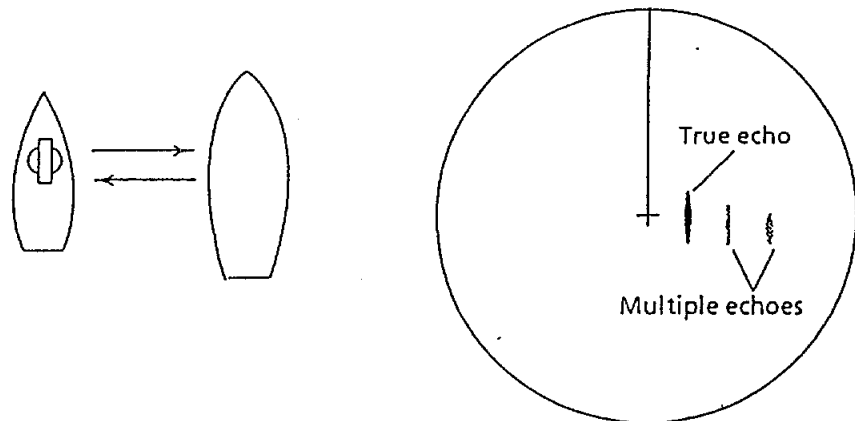

Figure 2-4 Multiple Echoes

Side-lobe echoes

Every time the scanner rotates, some radiation escapes on each side of the beam — called "side-lobes." If a target exists where it can be detected by the side-lobes as well as the main lobe, the side echoes may be represented on both sides of the true echo at the same range, as shown in Figure 2-5. Side-lobes show usually only at short ranges and from strong targets. They can be reduced through careful reduction of the gain or proper adjustment of the A/C SEA control.

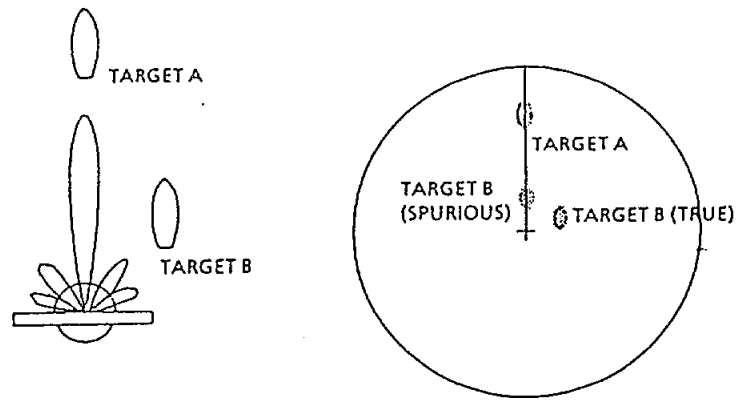

Figure 2-5 Side-lobe Echoes

Blind and shadow sectors

Funnels, stacks, masts, or derricks in the path of antenna may reduce the intensity of the radar beam. If the angle subtended at the scanner is more than a few degrees a blind sector may be produced. Within the blind sector small targets at close range may not be detected while larger targets at much greater ranges may be detected. See Figure 2-6.

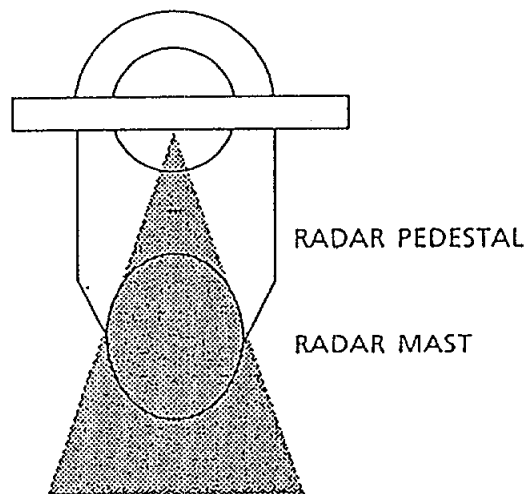

Figure 2-6 Blind and Shadow Sectors

Indirect echoes

Indirect echoes may be returned from either a passing ship or returned from a reflecting surface on your own ship, for example, a stack. In both cases, the echo will return from a legitimate contact to the antenna by the same indirect path. The echo will appear on the same bearing of the reflected surface, but at the same range as the direct echo. Figure 2-7 illustrates the effect of an indirect echo. Indirect echoes may be recognized as follows. (1) they usually occur in a shadow sector; (2) they appear on the bearing of the obstruction but at the range of the legitimate contact; (3) when plotted, their movements are usually abnormal, and (4) their shapes may indicate that they are not direct echoes.

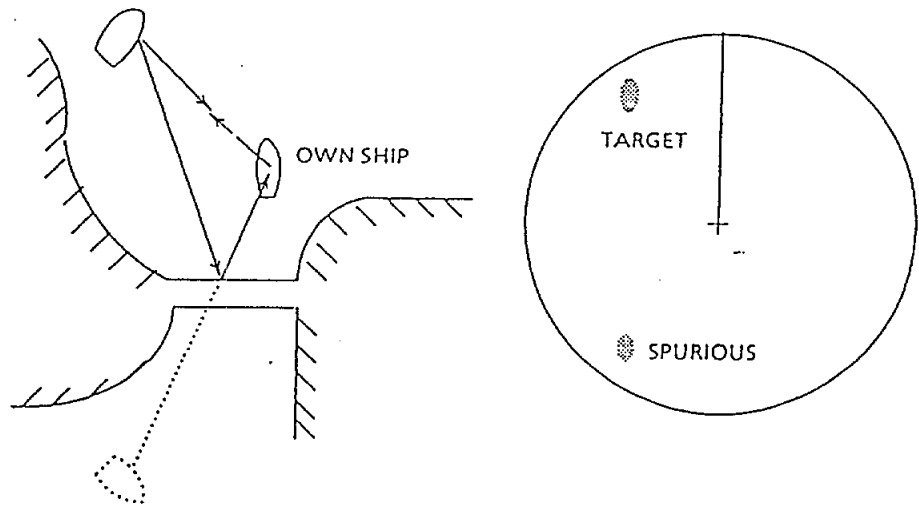

Figure 2-7 Indirect Echoes

Radar Picture and Corresponding Chart

Under normal conditions, a picture which is very similar to a chart can be obtained on the radar display. The radar picture and corresponding chart shown in Figure 2-8 are from the Kada Inland Sea, south of Osaka Bay, in Southwestern Japan.

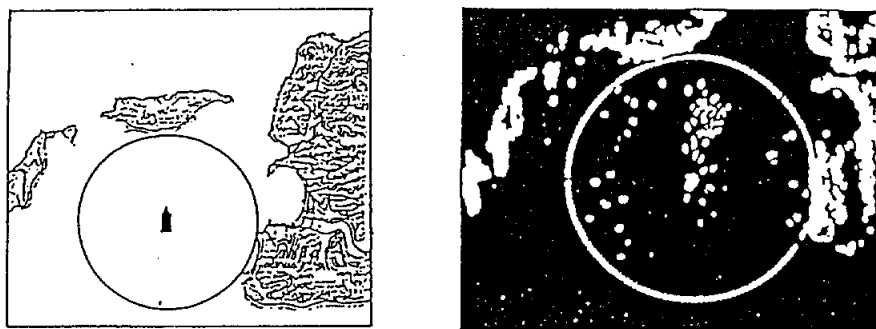

Figure 2-8 Navigation Chart and Corresponding Radar Picture

Position Fixing with Radar

Overview

Position fixing with radar can be accurately achieved once you become proficient in the different methods. The three most common methods will be discussed in this section. Take a compass and a navigation chart and try to fix your position while reviewing this section.

By radar range

The simultaneous measurement of the ranges to two or more fixed objects is normally the most accurate method of obtaining a fix with radar alone. Preferably at least three ranges should be used. However the use of more than three range arcs may introduce excessive error because of the time lag between measurements, namely, you will be moving as you take successive measurements.

When obtaining a fix, it is best to measure the most rapidly changing range last because of a smaller time lag in the radar plot from the ship's actual position. For greater accuracy, the objects selected should provide arcs with angles of cut as close to 90 degrees as possible. Small, isolated, radar-conspicuous fixed objects whose associated range arcs intersect at angles approaching 90 degrees provide the most reliable and accurate position fixes. Objects at longer ranges are less accurate for position fixing because they may be below the radar horizon and because the width of the radar beam increases with range.

To fix your position, first, measure the range to two or more prominent navigational marks which you can identify on the chart. Next, with the compass sweep out the ranges from the charted positions. The point of intersection of the arcs is your estimated position. The method of position fixing by radar range is illustrated in Figure 2-9.

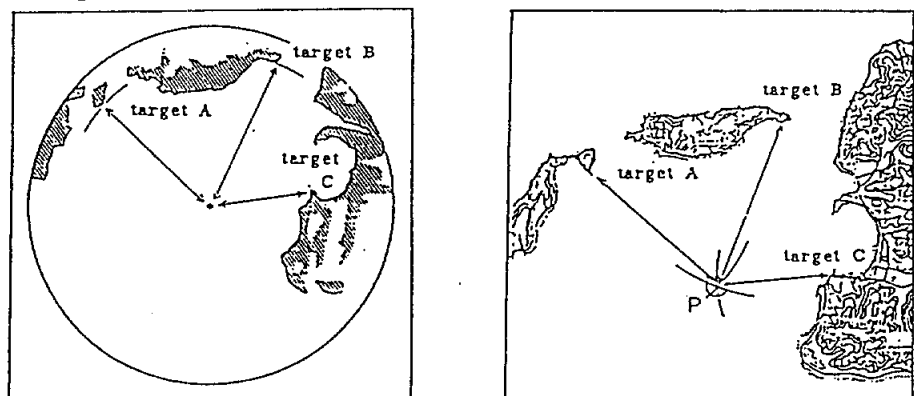

Figure 2-9 Position Fixing Using Radar Ranges

By range and bearing to a point of land

The advantage of position fixing by range and bearing to a point of land is the speed with which a fix can be obtained. A distinct disadvantage however is that this method is based upon only two intersecting position lines, a bearing line and range, obtained from two points of land. If possible, the object used should be small, isolated and identified with reasonable certainty. To fix your posi-

tion using range and radar bearing, first, measure the relative bearing of the target with the EBL, noting the exact direction of the ship's heading when doing so. Next, make allowance for compass deviation (true or magnetic) and find the true bearing of the target. Sweep out the range to the target with the compass on the chart and plot the true bearing of the target. The point of intersection is your approximate position. Figure 2-10 illustrates how to fix position by using a range and bearing to a point of land.

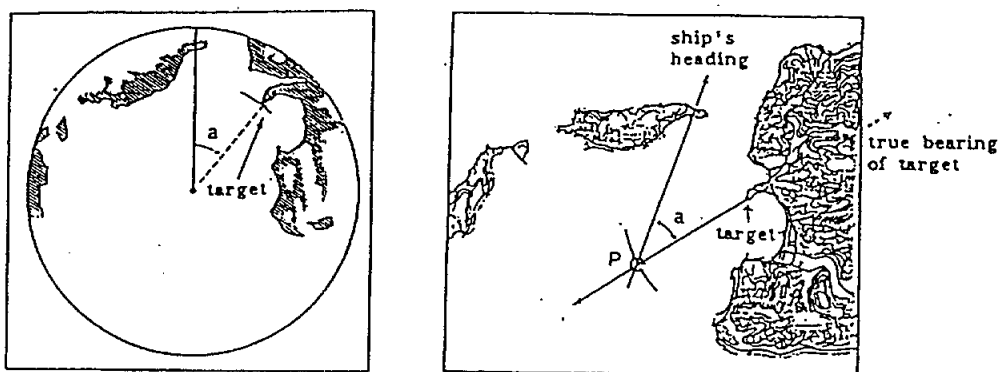

Figure 2-10 Position Fixing Using Range and Bearing to a Point of Land

By two bearings

Generally, fixes obtained from radar bearing are less accurate than those obtained from intersecting range arcs. The accuracy of fixing by this method is greater when the center bearings of small, isolated radar-conspicuous objects can be observed. Similar to position fixing using range and bearing, this method affords a quick means for initially determining approximate position. The position should then be checked against other means to confirm reliability.

Position fixing using two bearings is determined by measuring the relative bearings for the two targets and then determining their true bearings. Plot the two bearings on the chart; the point of intersection of the two bearings is your approximate position. Figure 2-11 illustrates the method of position fixing using two bearings.

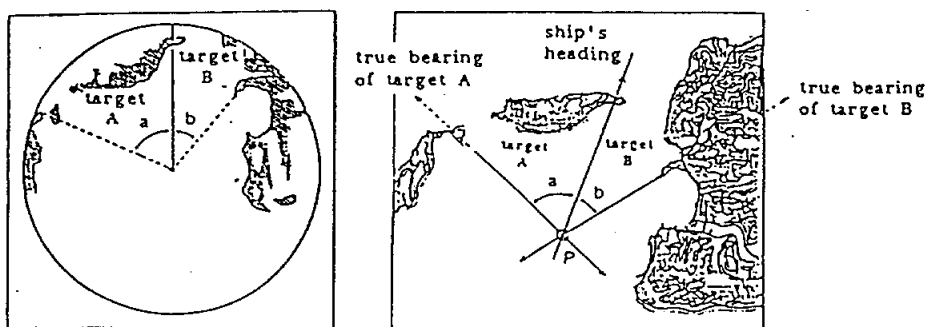

Figure 2-11 Position Fixing Using Two Bearings

Collision Avoidance and Relative Motion

Collisions at sea sometimes occur because the radar picture doesn't match the information provided by the eye in clear weather and because of the misunderstanding of relative motion.

In a relative motion display, your ship is represented by the spot of light fixed at the center of the screen, regardless of the speed of your own ship. With both your own ship and the target in motion, the successive pips of the target do not indicate the actual or true movement of the target. If your own ship is in motion, the pips of fixed objects, such as land masses, move on the display at a rate equal to and in a direction opposite to the motion of your own ship. Only when your ship is stopped or motionless do target pips move on the display in accordance with their true motion. Figure 2-12 illustrates the relative and true motion of a target contacted by radar.

In Figure 2-12, ship A, at geographic position A1 on true course of 001° at 14 knots initially observes ship B on the PPI at bearing 179° at 4.1 nautical miles. The bearing and distance to the ship changes as ship A proceeds from position A1 to A3. The changes in the position of ship B relative ship A are illustrated in the successive PPI presentations corresponding to the geographic positions of ships A and B. Likewise, ship B at geographic position B1, on true course 25° at 21 knots initially observes ship A on bearing 001° at 4.1 nautical miles.

The radar operator aboard ship A will determine that relative movement of ship B is approximately 66.5 degrees, whereas the operator aboard ship B will determine that the relative movement of ship A is approximately 238 degrees. These figures were obtained using a maneuvering board.

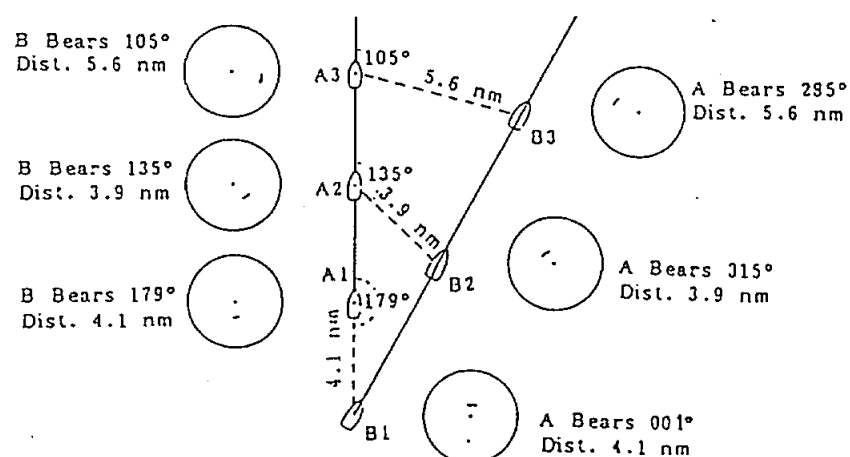

Figure 2-12 Relative Motion Versus True Motion

- *CAUTION: The 1972 Convention on the International Regulations for Preventing Collisions at Sea (1972 COLREGS) provides statutory requirements for the operation of any vessel, including the posting of lookouts. The operator of the vessel is responsible for compliance with those requirements whether or not a radar is in use.*

Assessing the risk

The moment an echo appears on the screen its range and relative bearing should be measured and its true or magnetic bearing noted. This is best done on a chart or plot. Collision risk can be assessed only by carefully watching the true or magnetic bearing of an approaching vessel. If the bearing of the target does not appreciably change a possibility of collision may exist.

3

MAINTENANCE

Overview

Regular maintenance is important for good performance. Following the procedures prescribed in this section will help keep this radar in good working order for many years.

Always keep the equipment as free as possible from dirt, dust and water splashes. Make sure that all screws securing the components are properly tightened.

BEFORE PERFORMING ANY MAINTENANCE:

- Please review the safety information at the beginning of this manual.
- Turn off the power to the radar. (Not necessary when cleaning the CRT.)

Contents

Regular Maintenance	3-2
Life Expectancy of Major Parts	3-3

Regular Maintenance

Use this table to perform regular maintenance.

Interval	Check Point	Check/Measures	Remarks
3 to 6 months	Exposed nuts and bolts on scanner unit	Check for corroded or loosened nuts and bolts. If necessary, clean them and repaint thickly. Replace them if heavily corroded.	Sealing compound may be used instead of paint. Lightly coat new nuts and bolts with grease.
	Scanner radiator	Check for dirt or cracks on the radiator surface. Thick dirt should be wiped off by using a soft cloth immersed in fresh water. If radiator is cracked, apply a slight amount of sealing compound or adhesive as a temporary remedy, then call for service.	DO NOT use plastic solvents such as acetone for cleaning. To remove ice on the scanner unit, use a wooden hammer or plastic-head hammer to prevent damage. Crack on the unit may cause water leakage, which can permanently damage the circuits inside.
	Terminal boards and plugs in scanner unit	Open scanner cover to check terminal boards and plugs inside. Also, check the rubber packing on the scanner cover for cracks.	When refitting the cover, be careful not to catch flying wires between cover and unit.
	CRT screen	Dirt on CRT creates symptoms identical to poor sensitivity. Clean CRT surface carefully.	Use a soft cloth with a slight amount of anti-static-charge spray. NEVER USE PLASTIC SOLVENTS.

(continued on next page)

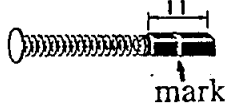
Interval	Check Point	Check/Measures	Remarks
6 months to 1 year	Scanner motor	Check and clean carbon brushes and commutator. If the mark on a brush is not visible replace brush.	Under normal use the carbon brush will last about 6000 hours. 
	Timing disc	Carbon given off by the drive motor may fall in slit of disc, causing the sweep to jump erratically.	Clean the disc with a brush. See Figure 5-9 for the location.
once a year	CRT anode and approach	High tension on CRT attracts dust and moist dust will cause poor insulation. ASK YOUR DEALER TO CLEAN ANY HIGH VOLTAGE PARTS.	If rubber cap or wire sheath is cracked, ask your dealer to replace damaged part.
	Terminal boards, sockets and plugs	Check for loose connections. Clean contacts or replace plug, if necessary.	

Life Expectancy of Major Parts

This table shows the life expectancy of major parts.

Part	Type	Life Expectancy *	Remarks
Scanner motor	RM-6585	about 10000 hrs. (gears)	wind speed 40 m/s
Magnetron	MG5223F	2000-4000 hrs.	

* Number of hours the radar has been transmitted appears on the ST-BY screen.

4

TROUBLESHOOTING

Overview

This section provides troubleshooting information for the service technician.

BEFORE BEGINNING ANY SERVICING, PLEASE REVIEW THE SAFETY INFORMATION AT THE BEGINNING OF THIS MANUAL.

Contents

Troubleshooting Table4-2

Troubleshooting Table

Use this table to identify defective parts.

IF...	AND...	THEN check...	ACTION
power is turned on and CRT brilliance is properly adjusted by the BRILL control	nothing appears on the display	fuse F1351, F5. mains voltage/polarity. CRT. CRT high voltage. SPU Board.	Measure mains voltage. <u>DC specification:</u> DTB1 #1(+) and #2(-) at rear of display unit. <u>CRT is normal if CRT heater is lit.</u>
	scanner is not rotating	scanner fuse F1352. scanner motor brushes. scanner rotating mechanism jammed.	Radar goes into ST-BY mode and "BRG SIG MISSING" appears if there is no bearing pulse input from scanner.
Radar transmitted, after entry into Stand-by mode.	marks, legends, etc. do not appear	SPU Board.	
	picture not synchronized	CRT assembly. SPU Board.	

(continued on next page)

IF...	AND...	THEN check...	ACTION
gain is adjusted with A/C SEA and A/C RAIN controls set at minimum	marks and legends appear but no noise nor echo	IF amplifier. coaxial cable in the multicore cable. VIDEO AMP Board.	Check continuity and isolation of coaxial cable with ohm meter. (Note: Disconnect the plug and lugs at both ends of coaxial before using ohm meter.)
	marks, legends and noise appear but no echo. (No transmission leak appears.)	TX HV fuse F1 (0.5A) magnetron. MODULATOR Board. MODULATION TRIGGER Board. Modulator SCR. SPU Board.	If fuse has blown, replace it. If it blows again, the magnetron or modulator circuit may be defective. Transmit the radar. Then, check magnetron current (voltage) between P801 #13 (+) and #5 (-) in scanner unit or INT pcb "MUG CUR" and "TP-GND" in display unit. It should be 5.5 to 7.5V.
	sweep rotation is not synchronized with antenna rotation	BEARING SIGNAL GENERATOR Board (scanner unit). SPU Board.	
	incorrect target bearing	SPU Board. GYRO PROCESSOR Board (optional).	"HDG SIG MISSING" appears on the screen when there is no heading pulse input.

(continued on next page)

FR: 14/50 DS

IF...	AND...	THEN check...	ACTION
gain is adjusted with A/C SEA and A/C RAIN controls set at minimum	there is poor sensitivity	magnetron. MIC.*	Transmit the radar. Then, check magnetron current (voltage) between P801 #13 (+) and #5 (-) in scanner unit or INT pcb "MUG CUR" and "TP-GND" in display unit. It should be 5.5 to 7.5V. Check MIC detecting current (Di monitor voltage) between P601 #10(+) and #8(-) in scanner unit. It should be 2.0 ± 0.2 V. If not, MIC may have detuned.
trackball is operated to move cross-hair cursor	cursor doesn't move	trackball. SPU Board.	
EBL or VRM is operated	marker doesn't move	SPU Board. PAF Board.	
a key is pressed	there is no response	key contact. SPU Board. MOTHER Board.	
a gyrocompass is connected	HDG readout is missing	connection between gyrocompass and display unit, or between INT Board and GYRO PROCESSOR Board.	After restoring readout, turn power off and on.

* Di monitor voltage is recorded on the label attached to the MIC. Check the voltage at Di MONIT (+) and GND (-) terminals on the MIC. If it is within $\pm 50\%$ of the rated value, the MIC is functioning properly.

5

LOCATION OF PARTS

Overview

This chapter shows the location of parts in the display and scanner units.

Contents

Display Unit	5-2
Scanner Unit	5-5

Display Unit

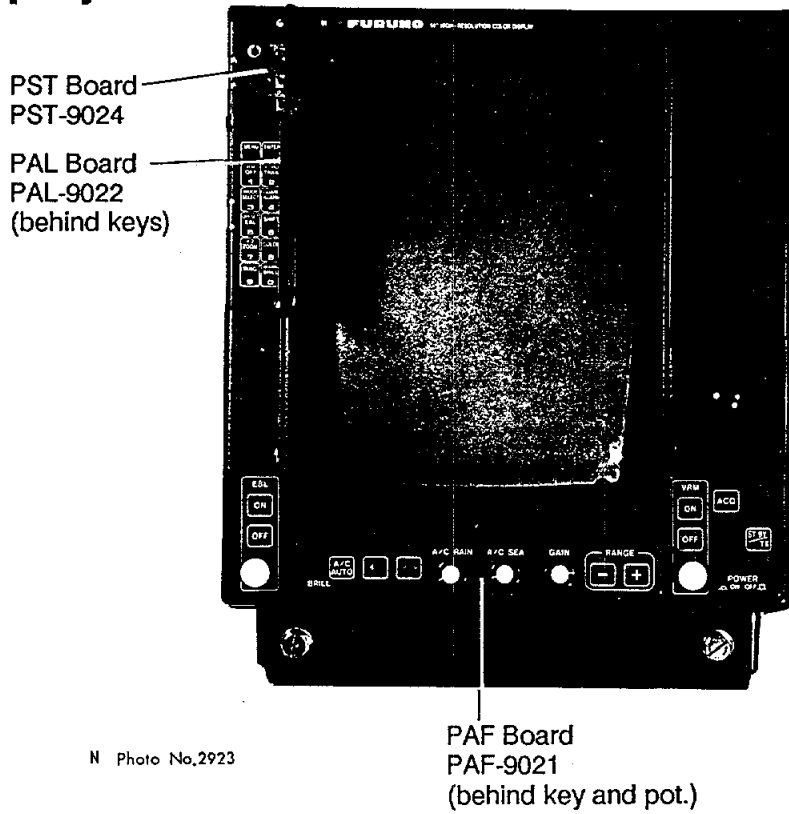

Figure 5-1 Display Unit, front view

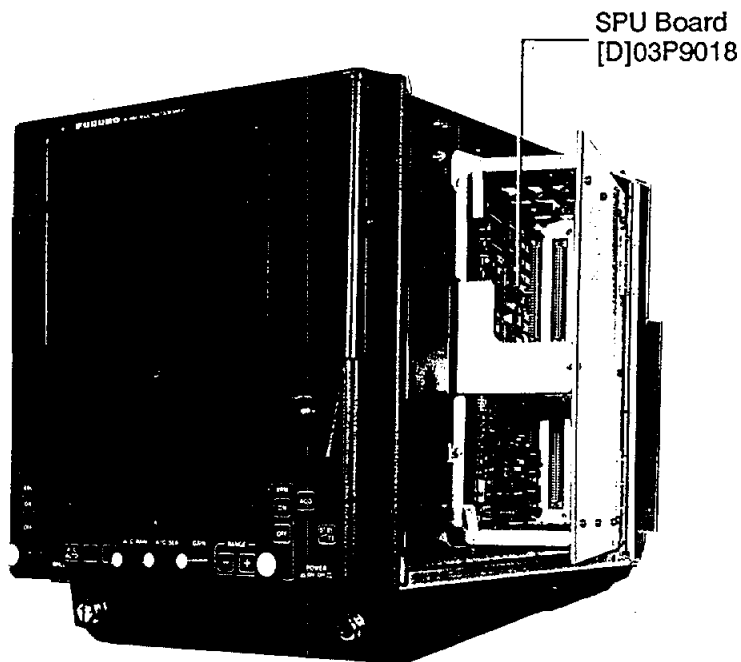

Figure 5-2 Display Unit, right view

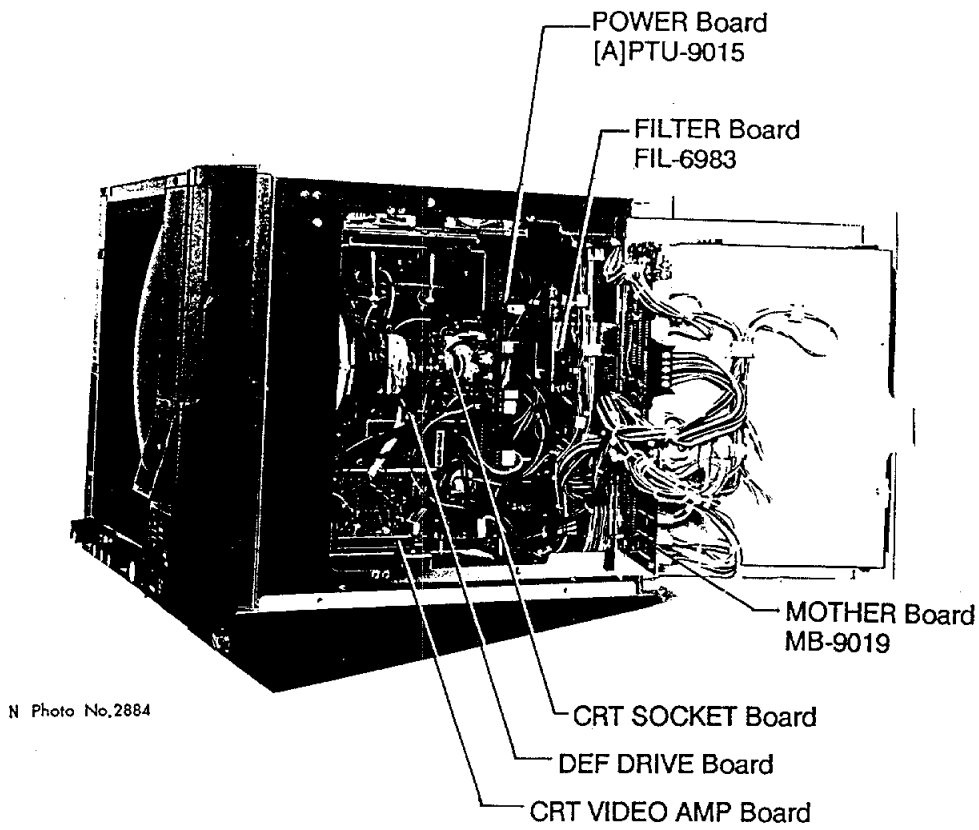

Figure 5-3 Display Unit, cover opened, right side view

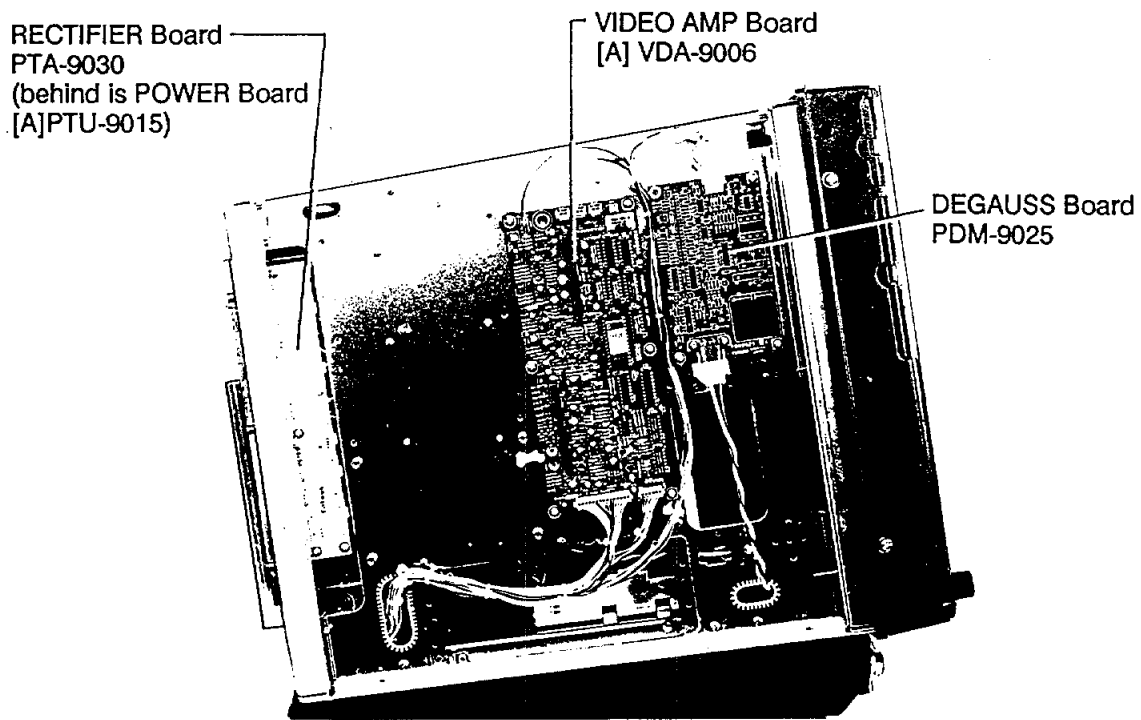

Figure 5-4 Display Unit, cover opened, left side view

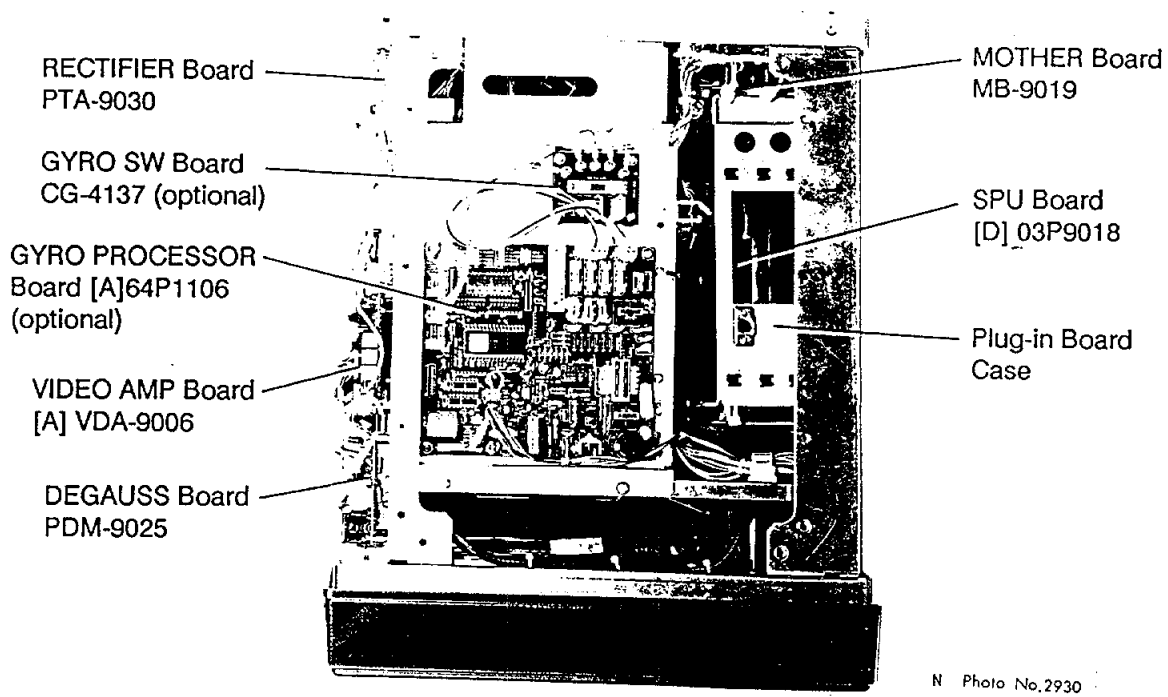

Figure 5-5 Display Unit, top view (cover opened)

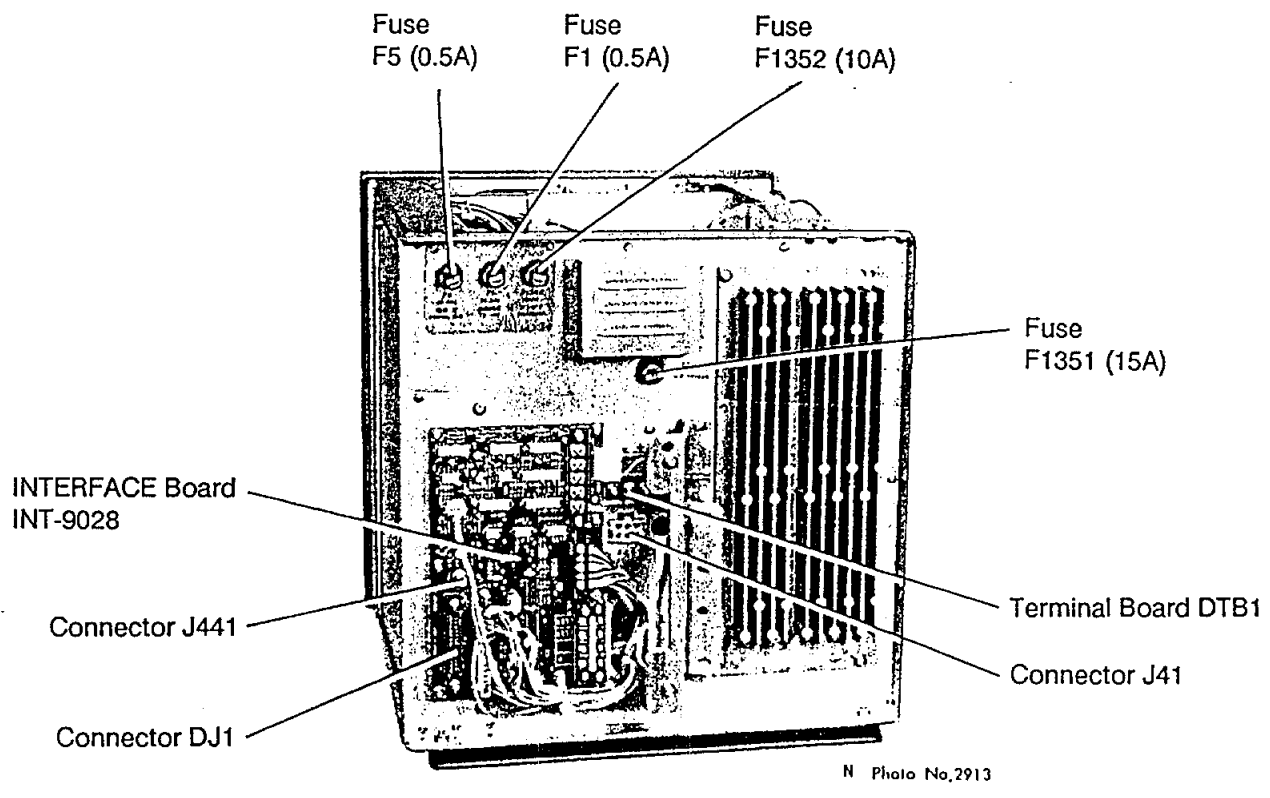

Figure 5-6 Display Unit, rear view

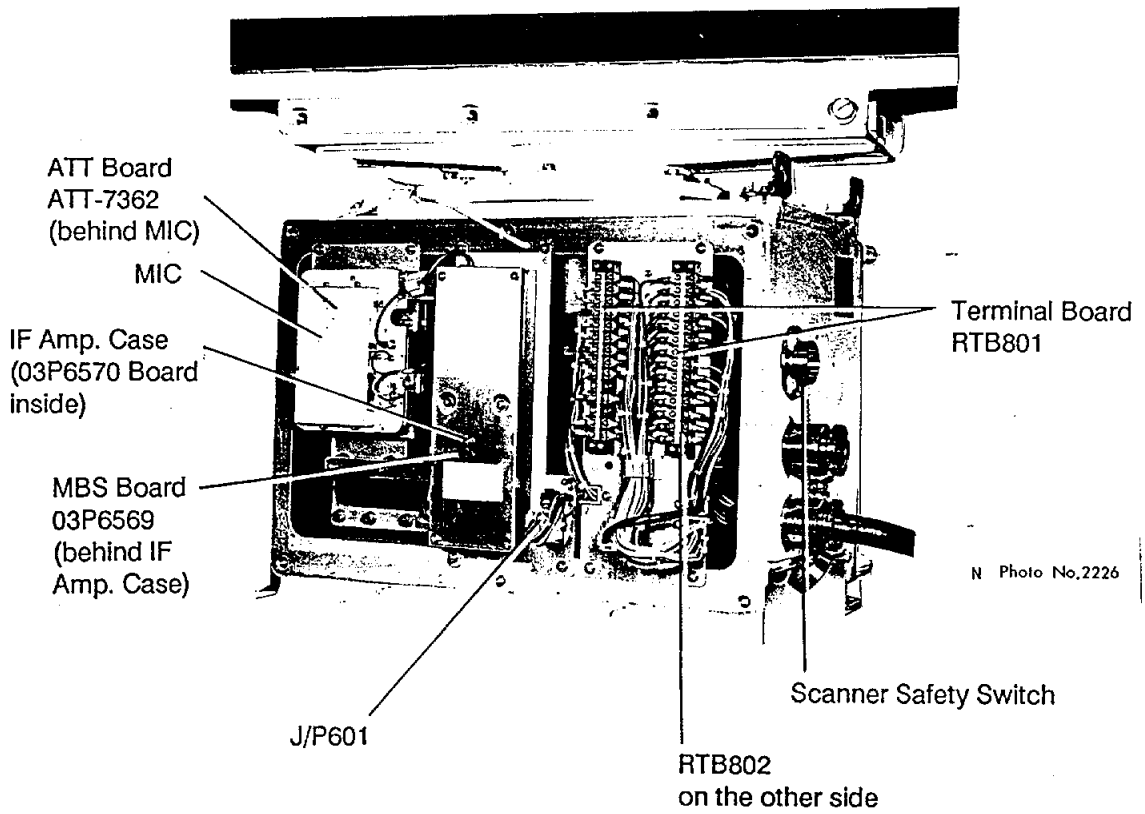

Figure 5-7 Scanner Unit, left side view

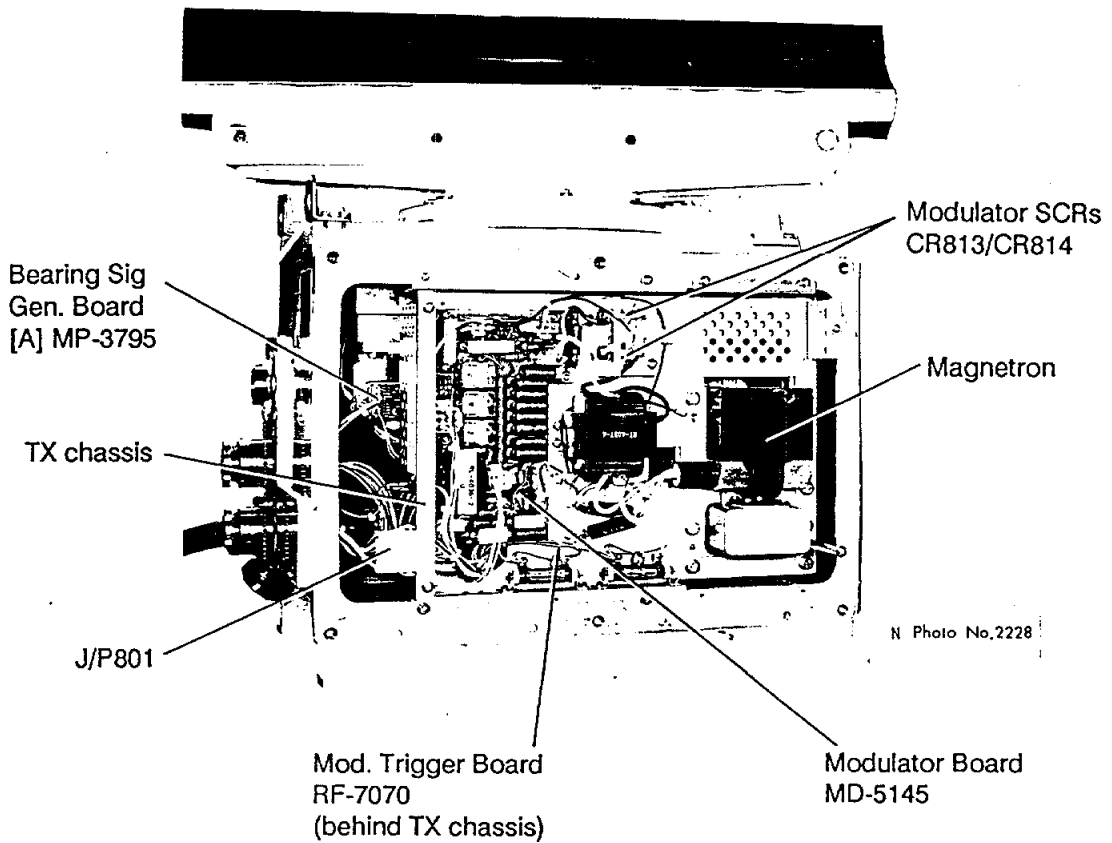

Figure 5-8 Scanner Unit, right side view (shield cover removed)

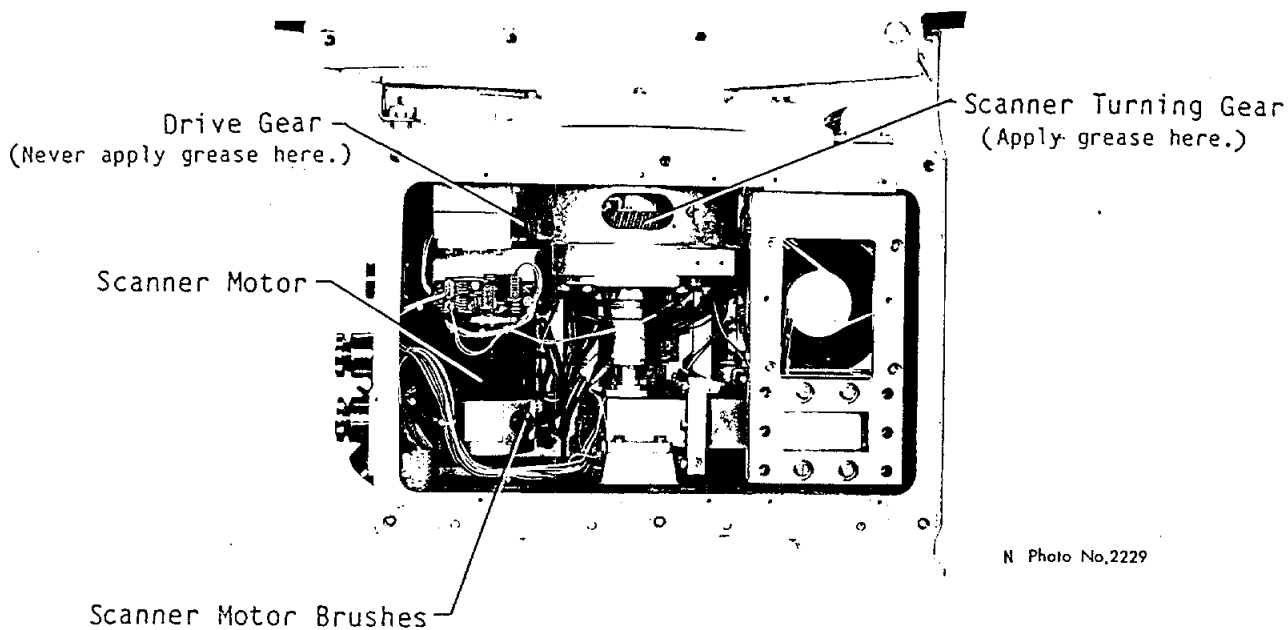

Figure 5-9 Scanner Unit, right side view (TX chassis removed)

